



HDMI over IP Video Extender VE8900 / VE8950 User Manual



www.aten.com

EMC Information

FEDERAL COMMUNICATIONS COMMISSION INTERFERENCE

STATEMENT: This equipment has been tested and found to comply with the limits for a Class A digital device, pursuant to Part 15 of the FCC Rules. These limits are designed to provide reasonable protection against harmful interference when the equipment is operated in a commercial environment. This equipment generates, uses, and can radiate radio frequency energy and, if not installed and used in accordance with the instruction manual, may cause harmful interference to radio communications. Operation of this equipment in a residential area is likely to cause harmful interference in which case the user will be required to correct the interference at his own expense.

FCC Caution: Any changes or modifications not expressly approved by the party responsible for compliance could void the user's authority to operate this equipment.

Warning: Operation of this equipment in a residential environment could cause radio interference.

Suggestion: Shielded twisted pair (STP) cables must be used with the unit to ensure compliance with FCC & CE standards.

This device complies with Part 15 of the FCC Rules. Operation is subject to the following two conditions: (1) this device may not cause harmful interference, and (2) this device must accept any interference received, including interference that may cause undesired operation.

RoHS

This product is RoHS compliant.



SJ/T 11364-2006

The following contains information that relates to China.

部件名称	有毒有害物质或元素					
	铅	汞	镉	六价铬	多溴联苯	多溴二苯醚
电器部件	●	○	○	○	○	○
机构部件	○	○	○	○	○	○

- : 表示该有毒有害物质在该部件所有均质材料中的含量均在SJ/T 11363-2006规定的限量要求之下。
- : 表示符合欧盟的豁免条款, 但该有毒有害物质至少在该部件的某一均质材料中的含量超出SJ/T 11363-2006的限量要求。
- ×: 表示该有毒有害物质至少在该部件的某一均质材料中的含量超出SJ/T 11363-2006的限量要求。

Preface

About This Manual

This User Manual is provided to help you get the most from your VE8900 / VE8950 device and the ATEN VE Manager. It covers all aspects of installation, configuration, and operation. An overview of the information found in the manual is provided below.

Chapter 1, Introduction and Getting Started, introduces you to the features and purposes of VE8900 / VE8950 HDMI over IP Video Extenders.

Chapter 2, Hardware Setup, introduces you to panel components and provides step-by-step instructions for installing and setting up your VE8900 / VE8950 hardware.

Chapter 3, Panel Operation, provides LED indicator information and functions of the panel pushbuttons.

Chapter 4, Management, provides an overview of the VE Manager's main screen and step-by-step instructions of creating and editing display layouts.

Chapter 5, System Settings, provides information on the general settings, and how to back up, restore, and upgrade the VE8900 / VE8950 system firmware.

Appendix, provides product safety instructions, technical support details, and product specifications.

Conventions

This manual uses the following conventions:

- Monospaced Indicates text that you should key in.
- [] Indicates keys you should press. For example, [Enter] means to press the **Enter** key. If keys need to be chorded, they appear together in the same bracket with a plus sign between them: [Ctrl+Alt].
1. Numbered lists represent procedures with sequential steps.
- ◆ Bullet lists provide information, but do not involve sequential steps.
- Indicates selecting the option (on a menu or dialog box, for example), that comes next. For example, Start → Run means to open the *Start* menu, and then select *Run*.
-  Indicates critical information.

Product Information

For information about all ATEN products and how they can help you connect without limits, visit ATEN on the Web or contact an ATEN Authorized Reseller. Visit ATEN on the Web for a list of locations and telephone numbers:

International	http://www.aten.com
North America	http://www.aten-usa.com

User Information

Online Registration

Be sure to register your product at our online support center:

International	http://eservice.aten.com
---------------	---

Telephone Support

For telephone support, call this number:

International	886-2-8692-6959
China	86-400-810-0-810
Japan	81-3-5615-5811
Korea	82-2-467-6789
North America	1-888-999-ATEN ext 4988
United Kingdom	44-8-4481-58923

User Notice

All information, documentation, and specifications contained in this manual are subject to change without prior notification by the manufacturer. The manufacturer makes no representations or warranties, either expressed or implied, with respect to the contents hereof and specifically disclaims any warranties as to merchantability or fitness for any particular purpose. Any of the manufacturer's software described in this manual is sold or licensed *as is*. Should the programs prove defective following their purchase, the buyer (and not the manufacturer, its distributor, or its dealer), assumes the entire cost of all necessary servicing, repair and any incidental or consequential damages resulting from any defect in the software.

The manufacturer of this system is not responsible for any radio and/or TV interference caused by unauthorized modifications to this device. It is the responsibility of the user to correct such interference.

The manufacturer is not responsible for any damage incurred in the operation of this system if the correct operational voltage setting was not selected prior to operation. **PLEASE VERIFY THAT THE VOLTAGE SETTING IS CORRECT BEFORE USE.**

Package Contents

Check to make sure that all of the components are present and in good order. If anything is missing or was damaged in shipping, contact your dealer.

VE8900T

- 1 VE8900 HDMI over IP Transmitter
- 1 RS-232 Terminal Block
- 1 5V Power Adapter
- 1 User Instructions

VE8900R

- 1 VE8900 HDMI over IP Receiver
- 1 RS-232 Terminal Block
- 1 5V Power Adapter
- 1 User Instructions

VE8950T

- 1 VE8950 4K HDMI over IP Transmitter
- 1 RS-232 Terminal Block
- 1 5V Power Adapter
- 1 User Instructions

VE8950R

- 1 VE8950 4K HDMI over IP Receiver
- 1 RS-232 Terminal Block
- 1 5V Power Adapter
- 1 User Instructions

Read this manual thoroughly and follow the installation and operation procedures carefully to prevent any damage to the device or to any other connected devices.

Note: The VE8900 / VE8950 product firmware may have been updated with new features after the release of this manual. For an up-to-date VE8900 / VE8950 user manual, visit <http://www.aten.com/global/en/>

Table of Contents

Preface

About This Manual	iv
Conventions	v
Product Information	v
User Information	vi
Package Contents	vii
Table of Contents	ix

1. Introduction and Getting Started

Overview	1
Features and Benefits	2
Getting Started Tasks	5

2. Hardware Setup

Components	7
VE8900T / VE8950T Rear View	8
VE8900R / VE8950R Front View	8
Mounting the VE8900 / VE8950 Device	10
Wall Mount	10
Rack Mount	10
Connecting VE8900 / VE8950	11

3. Panel Operation

Overview	15
Status LEDs	15
Panel Controls	16
Assigning Sources Using the Device Panel	17

4. Management

Overview	19
Looking Up the Login IP Address	20
Logging In and Configuring VE Manager	21
Assigning Sources Using VE Manager	24
The Main Screen	25
Configuring and Setting Up a Video Wall	27
Creating a Video Wall Layout	28

Editing a Video Wall Layout	30
Editing a Preview	31
Managing VE8900 / VE8950 Devices	32
Checking VE8900 / VE8950 Statuses	32
Setting a Source Video as Favorite	33

5. System Settings

Overview	35
General Settings	35
Transmitter Settings	37
Receiver Settings	39
Maintenance	41
Upgrading VE8900 / VE8950 Device Firmware	41
Backing Up VE8900 / VE8950 Device Settings	42
Restoring VE8900 / VE8950 Device Settings	43
Account Settings	44

Appendix

Safety Instructions	45
General	45
Rack Mounting	47
Technical Support	48
Specifications	49
Supported Browsers	51
Limited Warranty	52

Chapter 1

Introduction and Getting Started

Overview

The ATEN VE8900 / VE8950 Video over IP Extenders deliver visually lossless 1080p / 4K AV signals with low latency over long distance via a standard Gigabit network.

The VE8900 / VE8950 provides an effective, easy-to-use, and economical digital signage solution with the following features and advantages that directly address the challenges system integrators encounter when implementing AV over IP systems:

- ◆ Limitless scalability and flexibility
- ◆ No complicated IP setup
- ◆ No server PCs or software required
- ◆ Go further for less with daisy chaining

Engineered to meet today's demands of large scale, multi-display, 1080p/4K signal transmission, and designed to be easy to set up and operate, the VE8900 / VE8950 Video over IP Extender is an ideal product for a wide range of environments, such as trade shows, airports, university campuses, conference centers, and shopping centers.

Features and Benefits

Light weight Compression with Ultra-low Latency

- ◆ Delivers visually lossless high-quality video up to 1080p @ 60 Hz (VE8900) / 4K @ 30 Hz 4:4:4 (VE8950)
- ◆ Ensures stunning quality video using advanced video lossless compression technology
- ◆ EDID Expert™ selects the optimum EDID settings for smooth power-up, high quality display and the best video resolution across different screens

Limitless Scalability and Flexibility

- ◆ Extends AV connections from a simple point-to-point to a multi-point to multi-point setup via LAN without distance limitations
- ◆ Offers multi-functionality in extender, splitter, matrix switch, video wall and daisy chain applications
- ◆ Mix and match the latest 4K displays and 1080p screens. The built-in scaler automatically scales incoming video signals to match the maximum resolution of the connected display devices

Note*: VE8900R supports up to 1080p. Downscaling from 4K to 1080p is not available on this model.

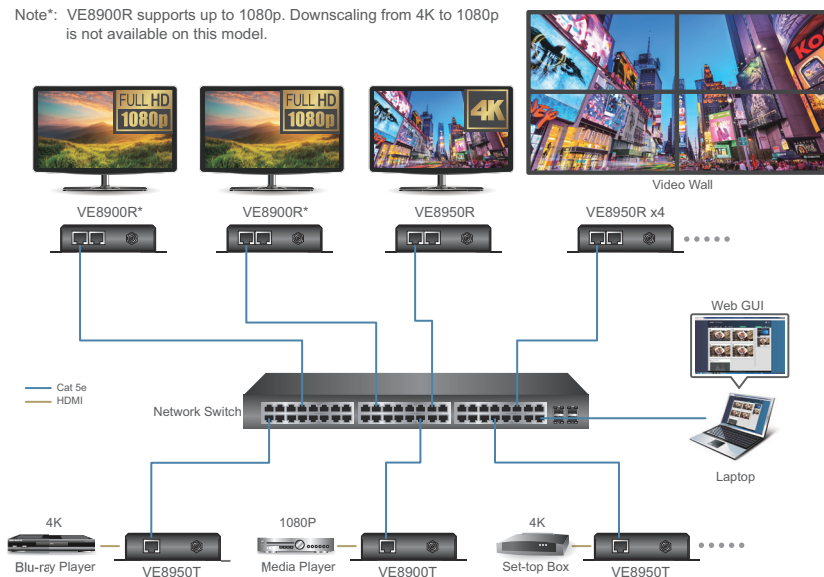

No Complicated IP Setup

- ◆ Simple configuration that requires no IT experience or extra learning
- ◆ Effortlessly switches among input sources via top panel pushbuttons

No Additional Server PCs or Software Required

- ◆ Supports web GUI for device management
- ◆ No additional server PCs, control boxes, or software/drivers are needed

Go Further For Less with Daisy Chaining

- ◆ Connects multiple displays through a single port to utilize every port of the network switch and maximize their value
- ◆ Easily expandable – cabling and system deployment is easy with no huge network switches and fewer cables needed
- ◆ Perfect for large-scale deployment covering hundreds of meters, such as hotel facilities, airports, university campuses, stations, shopping malls, and exhibition centers

Note: Depending on your network architecture, we recommend daisy chaining up to 30 units. Please contact ATEN representatives for more details.



Use daisy chains to configure a video wall or expand the AV system hundreds of meters

Video Wall Support

- ◆ Supports up to 8 x 8 video wall (64 displays)*
- ◆ Supports horizontal or vertical (90° rotation) display orientation
- ◆ Easily switches layout profiles, preview and drag-and-drop video sources via the intuitive web GUI

Note: If you experience issues related to your network architecture, please contact ATEN representatives for support.

Embedded / De-embedded Audio Support

- ◆ For VE8900T / VE8950T – separate audio signal can be embedded into the HDMI stream
- ◆ For VE8900R / VE8950R – audio stream can be extracted from the HDMI stream and delivered as a separate audio signal

Multiple Control Channels

- ◆ Multiple control methods – the system can be managed via Ethernet or top-panel pushbuttons
- ◆ USB Connectivity – USB port (USB 2.0) allows for connection of devices such as keyboard, mouse, flash drive, printer, and other USB peripherals
- ◆ Bi-directional IR Channel – IR transmission is processed one way at a time
- ◆ RS-232 Channel – bi-directional RS-232 serial port allows for connection of peripherals such as touch screens and bar code scanners

Getting Started Tasks

Follow the steps below to install, connect, configure, and getting started with your VE8900 / VE8950 devices.

1. Decide your network architecture and configuration. For more information, see the *Implementation Guide*.
2. Install the VE8900 / VE8950 devices. For more information, see *Mounting the VE8900 / VE8950 Device*, page 10.
3. Connect the VE8900 / VE8950 devices to sources, displays, network, and other hardware devices as required. For more information, see *Connecting VE8900 / VE8950*, page 11.
4. Use one of the following methods to assign input sources.

Note: Skip this step if you have a point-to-point setup. In a point-to-point setup, source input is automatically assigned.

- ◆ Assign input sources using the device panel.
For more information, see *Assigning Sources Using the Device Panel*, page 17.
- ◆ Assign input sources using VE Manager.
For more information, see *Logging In and Configuring VE Manager*, page 21 and *Assigning Sources Using VE Manager*, page 24.

This Page Intentionally Left Blank

Chapter 2

Hardware Setup



Before you proceed to hardware setup:

1. Please review the safety information regarding the placement of this device in *Safety Instructions*, page 45.
2. Do not power on the VE8900 / VE8950 device until all the necessary hardware is connected.

Components

VE8900T / VE8950T Front View

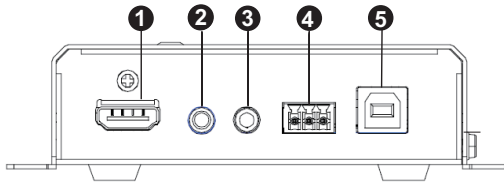

No.	Component	Function
1	HDMI In	Connects an HDMI cable from the source device.
2	Audio Jack	Connects to an analog audio player from the source device. Note that microphones are not supported.
3	IR Port	Connects to an IR receiver/transmitter to allow for configuration using a remote control.
4	RS-232 Terminal Block	Connects to a computer for serial control.
5	USB Type-B	Connects to a virtual media or a USB peripheral device.

VE8900T / VE8950T Rear View

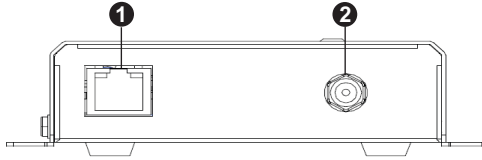

No.	Component	Function
1	LAN Port	Connects the unit to LAN with a network cable.
2	Power Jack	Connects to the DC power adapter to provide power to the unit.

VE8900R / VE8950R Front View

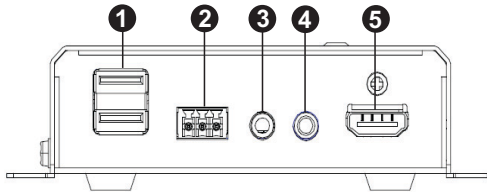

No.	Component	Function
1	USB Type-A	Connects to virtual media or a USB peripheral device.
2	RS-232 Terminal Block	Connects to a serial device.
3	Audio Jack	Connects to a speaker from the output device.
4	IR Port	Connects to an IR receiver/transmitter to allow for configuration using a remote control.
5	HDMI Out	Connects to an HDMI cable from the output device.

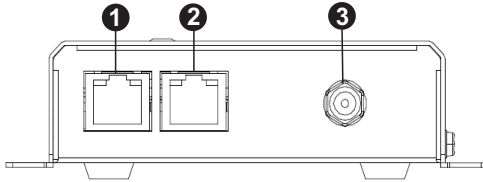
VE8900R / VE8950R Rear View

No.	Component	Function
1	LAN 1 Port	Connects the unit to LAN with a network cable.
2	LAN 2 Port	Connects to another VE8900R / VE8950R with a network cable in a daisy-chain setup.
3	Power Jack	Connects to the DC power adapter to provide power to the unit.

Mounting the VE8900 / VE8950 Device

Wall Mount

Secure or hang the VE8900 / VE8950 device to the wall using the built-in brackets.

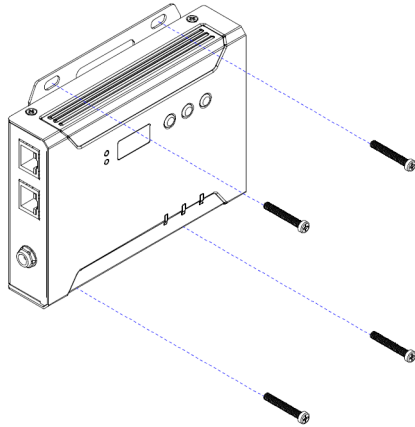

Rack Mount

Use the VE-RMK1U Rack Mount Kit to rack-mount the VE8900 / VE8950. For more information about this accessory, go to www.aten.com/products

Connecting VE8900 / VE8950

Follow the steps below to connect your VE8900 / VE8950 devices with the hardware as required.

Note:

- ◆ For details on LED indicators to help you identify statuses of connection or signal transmission, see *Status LEDs*, page 15.
- ◆ For a list of compatible ATEN products, visit the VE8900 / VE8950 product web page at www.aten.com

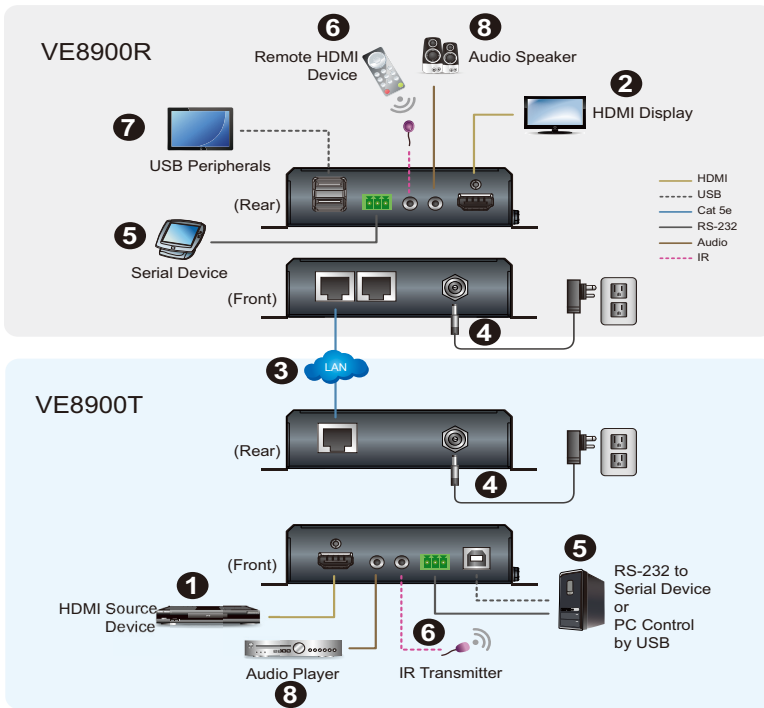

1. Connect the HDMI In port on the VE8900T / VE8950T device to the HDMI Out port on your video source device using an HDMI cable.*
2. Connect the HDMI Out port on the VE8900R / VE8950R device to the HDMI In port on your display device using an HDMI cable.
3. Depending on your deployment type, connect your VE8900T / VE8950T and VE8900R / VE8950R to the same LAN.
 - ◆ Point-to-point deployment: directly connect the LAN 1 Ports of your VE8900T / VE8950T and VE8900R / VE8950R with an RJ-45 cable.
 - ◆ Splitter and matrix deployment: connect the LAN 1 Ports of your VE8900T / VE8950T and VE8900R / VE8950R to the same network switch with RJ-45 cables.
4. Plug the Power Adapter into the Power Jack on the VE8900T / VE8950T and VE8900R / VE8950R devices.
5. (Optional) Connect an RS-232 serial device or peripheral to the RS-232 Terminal Block on your VE8900R / VE8950R device. This device can be a computer, touch screen, bar code scanner, or control system.*
6. (Optional) Connect an IR transmitter/receiver cable to the IR Ports of your VE8900T / VE8950T and VE8900R / VE8950R devices.*
7. (Optional) Connect USB peripherals to the USB ports on your VE8900T / VE8950T and VE8900R / VE8950R devices.*
8. (Optional) Connect an audio device to the VE8900R / VE8950R Audio Jack.

Note:

- ◆ To receive HDMI audio on the VE8900 / VE8950 transmitter, make sure to configure the following in VE Manager:
 - ◆ Set the transmitter to receive HDMI audio:
Go to **System Settings > Transmitter > Audio In** in VE Manager and change the setting to **HDMI**.
- ◆ To allow for 5.1 or 7.1 surround sound on a VE8900 / VE8950 receiver, do the following:
 1. In VE Manager, go to **System Settings > Transmitter**, access the configuration window for the corresponding transmitter, and then set EDID to **Manual**.
 2. From the VE Manager's preview area, right-click the receiver and select EDID to allow transmission of the receiver's EDID to the transmitter.

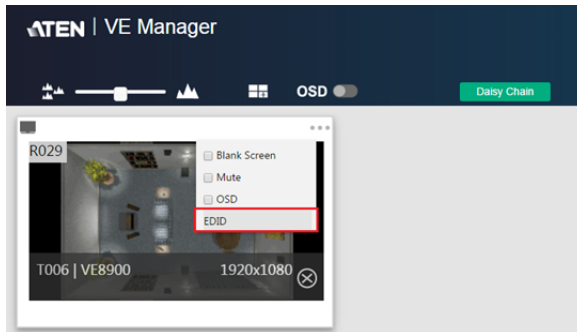

- ◆ The IR, RS-232, and USB signal transmissions are disabled by default. To enable the functions, go to **System Settings > Receiver > IR/RS232** or **USB** in VE Manager and select the signal source.
-

This Page Intentionally Left Blank

Chapter 3

Panel Operation

Overview

This chapter provides information on panel LEDs and instructions to operate the VE8900 / VE8950 using the panel buttons.

Status LEDs

Both the VE8900 / VE8950 Transmitter and Receiver have front panel LEDs to indicate their operating and power status.

LED	Indication	Description
Power	Lights green	The device is powered on.
	Off	Power is off.
LINK	Lights orange	LAN is connected.
	Off	LAN is not connected.
HDMI Out	Lights orange	The video output is stable.
	Blinks orange	The video output is unstable.
	Off	The video output is not transmitted.
RJ-45 Connector (Left LED)	Lights orange	Data is being transmitted at 100Mbps.
	Lights green	Data is being transmitted at 1Gbps.
RJ-45 Connector (Right LED)	Lights green	LAN is connected and no data is being transmitted.
	Blinks green	LAN is connected and data is being transmitted.

Note: The HDMI Out LED is only available on VE8900 / VE8950 receivers.

Panel Controls

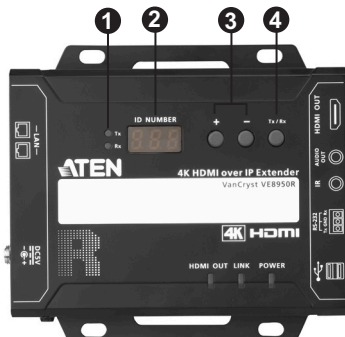

VE8950 Receiver



VE8950 Transmitter

No.	Name	Description
1.	Tx/Rx LEDs	Lights to indicate whether the displayed ID number is of Tx or Rx.
2.	ID Number	<ul style="list-style-type: none"> ◆ Transmitter side: Identifies its ID number ◆ Receiver side: Identifies its ID number or the transmitter's ID number when the panel control is switched to Tx <p>An ID Number blinks to indicate that it is been used by another VE8900 / VE8950 device.</p>
3.	Up (+) / Down (-) Buttons	<ul style="list-style-type: none"> ◆ Assign ID numbers on VE8900 / VE8950 devices. ◆ Assign the source video (transmitter) for the receiver
4.	Tx/Rx Switch Button	Press to switch control between a receiver and its corresponding transmitter.

Note:

- ◆ The VE8900 / VE8950 device automatically locks its panel when it idles for 1 minute. To unlock the panel, press and hold the **Down (-)** button for 3 seconds.
- ◆ **Tx/Rx LEDs** and **Tx/Rx Switch Button** are only available on VE8900 / VE8950 receivers.

Assigning Sources Using the Device Panel

1. Assign an ID number to each of your VE8900R / VE8950R devices.
 - a) On a VE8900R / VE8950R device, make sure the control is switched to Rx, in which case the **Rx** LED lights up. If not, press the **Tx/Rx** switch button.
 - b) Use the **Up (+)** and **Down (-)** buttons to assign an ID number to this receiver.
 - c) Repeat steps 1 (a) and 1 (b) on each of your VE8900R / VE8950R devices.
2. For a matrix setup, assign an ID number to each of your VE8900T / VE8950T devices.
 - a) On a VE8900T / VE8950T device, use the **Up (+)** and **Down (-)** buttons to assign an ID number to this transmitter.
 - b) Repeat step 2 (a) on each of your VE8900T / VE8950T devices.
3. Assign source inputs to your VE8900R / VE8950R devices.
 - a) On a VE8900R / VE8950R device, press the **Tx/Rx** switch button to switch the control to Tx, in which case the **Tx** LED lights up.
 - b) Use the **Up (+)** and **Down (-)** buttons to assign a source input to this receiver.
 - c) Repeat steps 3 (a) and 3 (b) on each of your VE8900R / VE8950R devices.

This Page Intentionally Left Blank

Chapter 4 Management

Overview

ATEN VE8900 / VE8950 HDMI over IP Video Extenders can be remotely and centrally managed using a built-in utility program, the ATEN VE Manager. Accessed through a web browser, this utility provides a central platform that allows you to do the following:

Feature	Details
Configure transmitter and receiver settings	See <i>Transmitter Settings</i> , page 37 and <i>Receiver Settings</i> , page 39.
Monitor transmitter and receiver statuses	See <i>Checking VE8900 / VE8950 Statuses</i> , page 32.
Create display templates	See <i>Creating a Video Wall Layout</i> , page 28.

Looking Up the Login IP Address

Follow the steps below to download IP Installer utility, and use the utility to look up the IP address of your VE8900 / VE8950 transmitter.

1. Download the IP Installer utility from the VE8900 / VE8950 web page: www.aten.com/download
2. Unzip and execute the downloaded IP Installer. The Network Device IP Installer screen appears.
3. Click **Enumerate** to search for ATEN devices in the network. The detected devices are shown in Device List.
4. Use the IP address of any VE8900 / VE8950 transmitter to log in VE Manager.

Logging In and Configuring VE Manager

On a computer with web access, follow the steps below to log in VE Manager.

1. Open a web browser and type the IP address you obtained using IP Installer Utility. This screen appears.

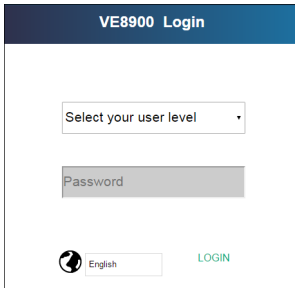

2. Select **Administrator** for User Level and type **password** for the Password field. This screen appears upon first login.

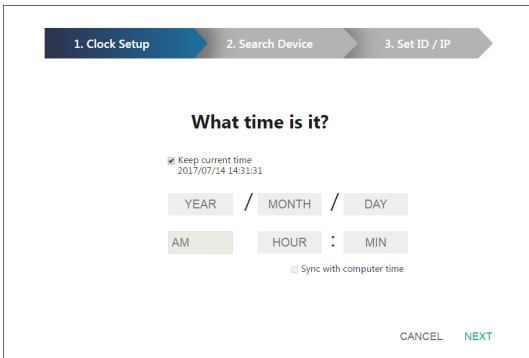

3. Specify a date and time for the VE Manager using one of the following methods:
 - ♦ To keep the current date and time settings, select **Keep current time**.
 - ♦ To adopt the date and time settings of the endpoint used to access VE Manager, select **Sync with computer time**.
 - ♦ To specify a different date and time, type the desired date and time. Make sure the date is typed in this format: YYYY/MM/DD.

4. Click **NEXT**. This screen appears. The setup wizard lists the VE8900 / VE8950 transmitters and receivers found in the network.

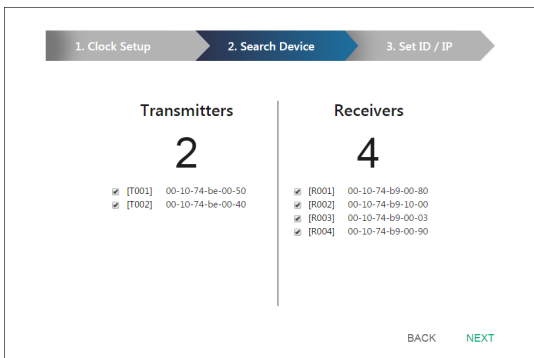

5. To configure device IP addresses, select the devices from the list, and then click **Next**. This screen appears.

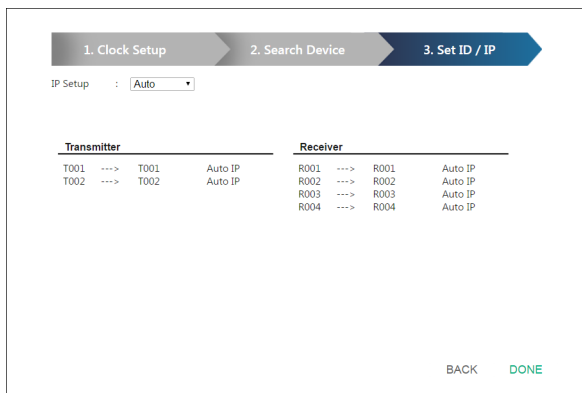

6. Click the **IP Setup** drop-down box to select a method for assigning IP addresses to the managed VE8900 / VE8950 devices.
- ◆ **Auto:** Select this option to have IP addresses automatically assigned by VE Manager.
 - ◆ **DHCP:** Select this option to have IP addresses dynamically assigned by a DHCP server.
 - ◆ **Manual:** Select this option to designate IP addresses for the managed video extenders. For details, see the step below.

7. To manually assign IP addresses, follow the steps below.
- a) From the Set ID / IP page, select **Manual** for IP Setup. This screen appears.

1. Clock Setup 2. Search Device 3. Set ID / IP

IP Setup : **Manual**
Input IP Range ex: 192.168.0.100 - 200

Transmitter: -

Receiver: -

Transmitter			Receiver		
T001	--->	T001	R001	--->	R001
T002	--->	T002	R002	--->	R002
			R003	--->	R003
			R004	--->	R004

BACK DONE

- b) In the Transmitter and Receiver fields, type valid IP address ranges.
- c) Click **Refresh** to start assigning IP addresses.
- d) When the assignment is complete, VE Manager displays the assigned IP addresses.
8. To re-assign device IDs, click and type a new ID for the target VE8900 / VE8950 device.

1. Clock Setup 2. Search Device 3. Set ID / IP

IP Setup : **Auto**

Transmitter			Receiver		
T001	--->	T001	R001	--->	R001
T002	--->	T002	R002	--->	R002
		Auto IP	R003	--->	R003
		Auto IP	R004	--->	R004
					Auto IP
					Auto IP
					Auto IP

9. Click **Done**. The VE Manager's main screen appears.

Note:

- For security reasons, ATEN recommends changing the password at first login. For details on account settings, see *Account Settings*, page 44.
- To access these settings again, click from the VE Manager's main screen, and then click .

Assigning Sources Using VE Manager

Follow the steps below to assign input sources using VE Manager.

- From the main screen, click , and then click the **Receiver** tab. The managed VE8900 / VE8950 receivers appear.

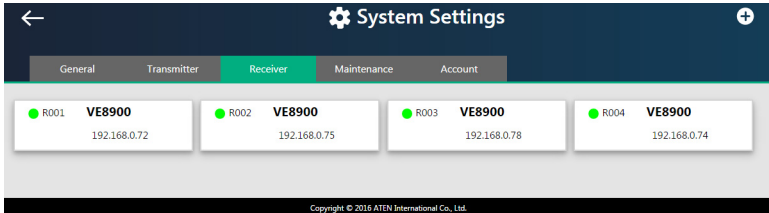

- Assign a source for each of the VE8900 / VE8950 receivers.
 - Move the cursor to a receiver. A green arrow appears at the top right corner of the receiver preview window.
 - Click the green arrow. A drop-down menu appears.

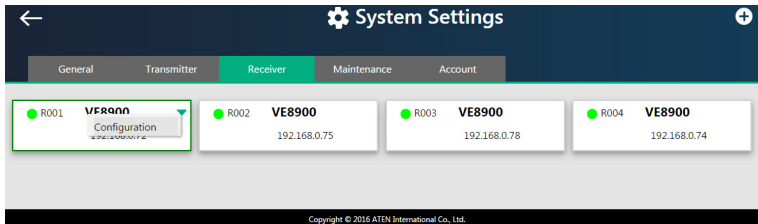

- From the drop-down menu, click **Configuration**. This window appears.

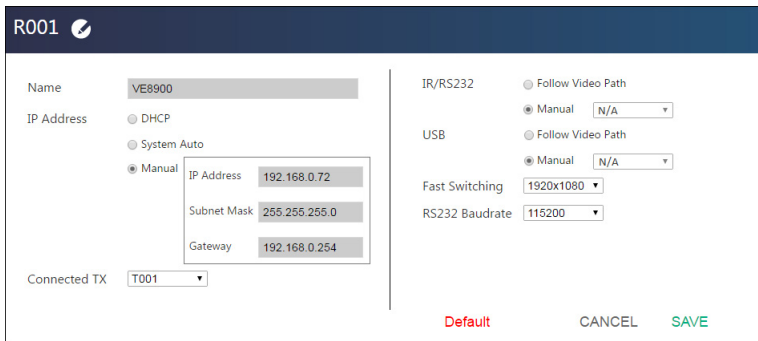

- Click the **Connected Tx** drop-down arrow and select a Tx source.
- Repeat steps 2 (a) to 2 (d) to assign sources for each of the receivers.

The Main Screen

You can access the following controls from the VE Manager's main screen.

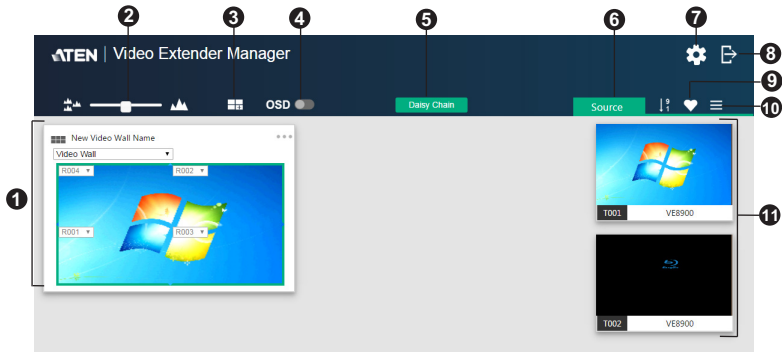

No.	Component	Description
1	Previews for Video Walls and Receivers	Shows a preview of created video walls, individual video receivers, and daisy chain setups. <ul style="list-style-type: none"> For details about creating video wall templates, see <i>Creating a Video Wall Layout</i>, page 28. For details about controls in a preview, see <i>Editing a Preview</i>, page 31.
2	Preview Size	Drag the slider bar to adjust the size of preview windows.
3	Create/Edit Video Wall	Click to create [or edit] video wall templates. For details, see <i>Configuring and Setting Up a Video Wall</i> , page 27.
4	OSD	Globally enables or disables panel control of the VE8900 / VE8950 devices used in managed video walls. To enable or disable panel control of VE8900 / VE8950 devices for a single video wall, use the OSD setting for a preview window. For details, see Configuration Menu in <i>Editing a Preview</i> , page 31.

No.	Component	Description
5	Daisy Chain	Click to detect daisy chain setups.
6	Sorting Tool	Click to sort the display sources in ascending or descending order by device IDs.
7	System Settings	Click to access system settings, including the general settings, transmitter settings, receiver settings, firmware update, backup, and restore settings, and account settings. For more details, see Chapter 5, System Settings.
8	Log Out	Click to log out VE Manager.
9	Favorite	This is a list of display sources that the user marked for quick access. Click to display or hide the list. For details, see <i>Managing VE8900 / VE8950 Devices</i> , page 32.
10	Source List Display Mode	Click to list transmitters (Source List) using preview windows or device names.
11	Source List	Lists the display sources and identifies each source with its corresponding transmitter.

Configuring and Setting Up a Video Wall

To configure a video wall, follow the steps below.

1. Make sure you have created a video wall template for your specific needs. For detailed steps, see *Creating a Video Wall Layout*, page 28.
2. From the VE Manager's main screen, drag and drop input sources from the Source List onto the created video wall layout. In the following example, the display source **T002** is assigned to this video wall layout, which has four monitors, **R001** to **R004**, merged to form an enlarged display of one source video.

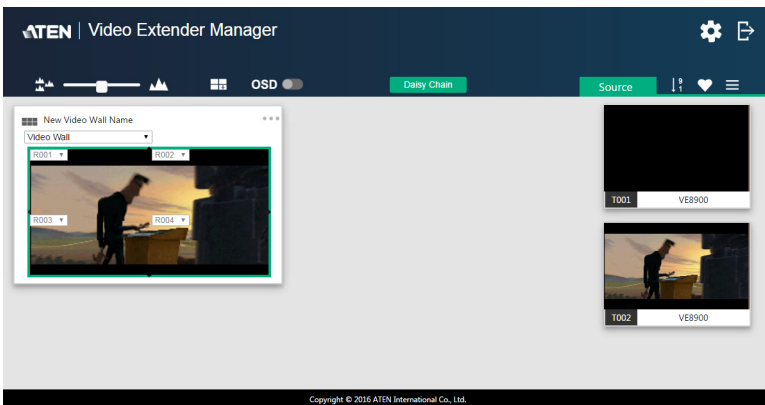

Note: For details on editing video wall settings, see *Editing a Preview*, page 31 and *Editing a Preview*, page 31.

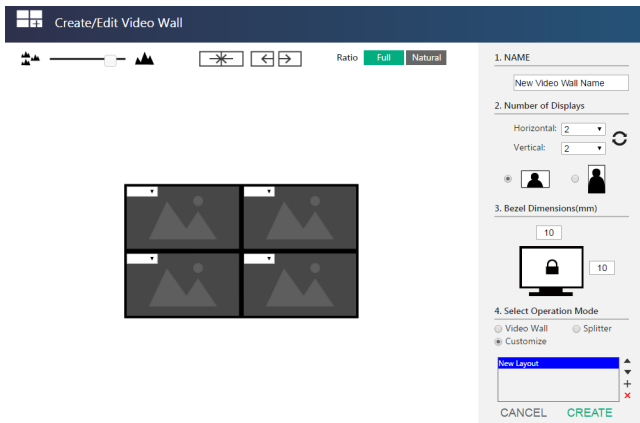

Creating a Video Wall Layout

1. To create a new layout, click **Create/Edit Video Wall** from the main screen. This window appears. A preview of the layout is shown in the middle.



2. Configure your video wall layout as required. Use the preview to help you visualize the layout.

Control	Description
Name	Type to name this video wall layout.
Number of Displays	Define the following parameters. <ul style="list-style-type: none"> ♦ Horizontal and Vertical: Click the drop-down boxes to select the number of displays for your video wall. Click Refresh to show a preview of your configuration. ♦ Display orientation: Select horizontal or vertical display. A vertical display is a 90° clockwise rotation of the horizontal display.
Bezel Dimensions	Type to specify the top/bottom and right/left widths of the monitor frame.

Control	Description
Operation Mode	Select an operation mode for your video wall. <ul style="list-style-type: none"> ♦ Video Wall: Select this option to set up a video wall. ♦ Splitter: Select this option to set up a display of identical content on multiple monitors. ♦ Customized: Select this option to create a customized display. Click New layout in the list to rename this template.
	Click and hold the slider bar to enlarge or reduce the size of preview windows.
	Use this button to merge displays. Click to select the desired monitors from the layout preview and click the button to merge the monitors.
	Use this button to separate already merged monitors. Select a merged monitor from the layout preview, and then click the button.
Ratio <input checked="" type="radio"/> Full <input type="radio"/> Natural	Full: Click to display source videos in full extension. Natural: Click to displays source videos in their original aspect ratio.

- From the preview area, click the drop-down boxes to define the output receiver for each monitor. An already selected, unavailable receiver is marked with an asterisk (*).

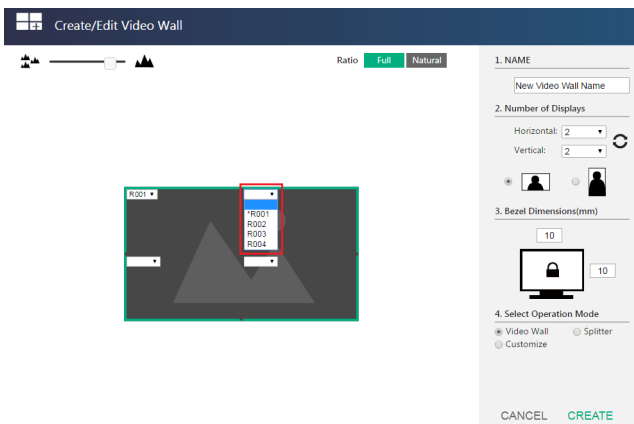

4. Click **CREATE**. The new video wall template is created and displayed on the main screen.

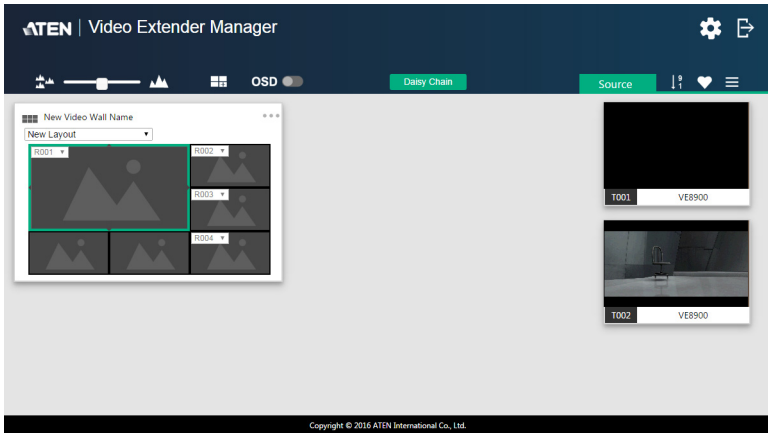

Editing a Video Wall Layout

To edit a video wall layout, from the VE Manager's main screen, click the top-right corner of the layout you wish to edit, and then select **Edit**. For more details on video wall settings, see *Creating a Video Wall Layout*, page 28.

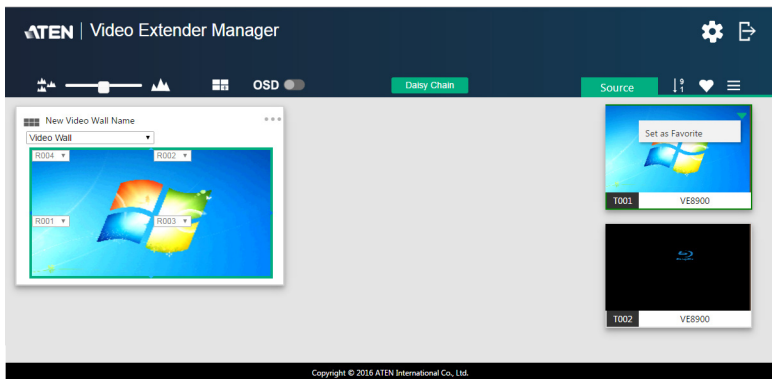

Editing a Preview

You can edit the following settings for a video wall layout.

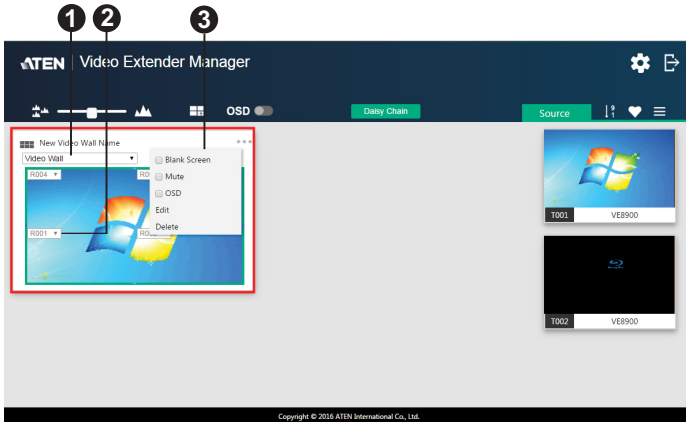

No.	Control	Description
1.	Operation Mode	Click the drop-down list to select an operation mode.
2.	Assigned Receiver	Displays the assigned receiver for the monitor. Tip: For an un-merged monitor, double-click the monitor to open up the settings page for the assigned receiver.
3.	Configuration Menu	Click the top-right corner to access the following controls: <ul style="list-style-type: none"> ◆ Blank: Disables the display on this video wall. ◆ Mute: Disables audio transmission to this video wall. ◆ OSD: Enables or disables the panel control of all VE8900 / VE8950 devices for this video wall. ◆ Edit: Click to access the video wall layout settings. For more details on video wall settings, see <i>Creating a Video Wall Layout</i>, page 28. ◆ Delete: Click to remove this layout from VE Manager. For a receiver, this option is only available when it is offline.

Managing VE8900 / VE8950 Devices

Checking VE8900 / VE8950 Statuses

You can check the statuses of your VE8900 / VE8950 devices using by clicking  from the main screen, and then the **Transmitter** or **Receiver** tab.

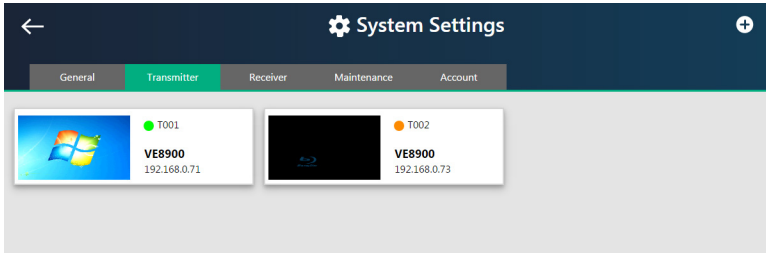

The status for a VE8900 / VE8950 device is indicated with a colored circle. See the table below for status indicators and the corresponding descriptions.

Indicator	Description
Green	The device is connected and active.
Orange	The device is on standby.
Grey	The device is offline.

Setting a Source Video as Favorite

To set a frequently used source video as **Favorite** for quick access, follow the steps below.

1. Move your cursor to the source video in the Source List. A green arrow appears at the top-right corner.
2. Click the green arrow. A drop-down menu appears.

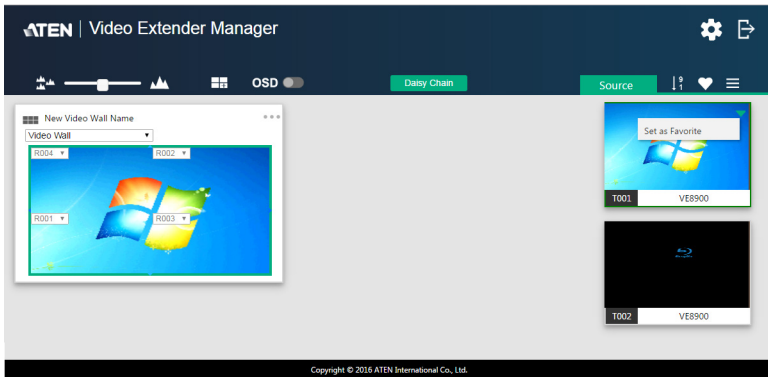

3. Select **Set as favorite**. The transmitter is marked as favorite.

This Page Intentionally Left Blank

Chapter 5

System Settings

Overview

The System Settings page allows you to specify device date and time, configure settings of connected VE8900 / VE8950 devices, upgrade device firmware, and back up the VE Manager's settings.

General Settings

The General tab contains the date, time, and panel lock settings.

The screenshot shows the 'System Settings' application interface. At the top, there is a navigation bar with a back arrow, a gear icon, the title 'System Settings', and a plus icon. Below this is a tabbed interface with five tabs: 'General' (selected), 'Transmitter', 'Receiver', 'Maintenance', and 'Account'. The main content area is titled 'Time' and contains input fields for 'YEAR' (2017), 'MONTH' (07), and 'DAY' (14). To the right of these fields is the current date and time: '2017/07/14 14:12:03'. Below the date fields are 'AM/PM' (PM), 'HOUR' (02), and 'Minute' (12) fields. A 'Set' button is located to the right of the minute field. Below the time fields is the 'Auto Key Lock' section, which has two radio buttons: 'Enable' (selected) and 'Disable'. At the bottom of the form are 'Reset' and 'Apply' buttons. A copyright notice 'Copyright © 2016 ATEN International Co., Ltd.' is visible at the very bottom of the screen.

To access the General tab, click  from the main screen, and then click the **General** tab.

- ◆ **Date and time:** Click and type the desired information and click **Set** to save the settings.
- ◆ **Auto Key Lock:** Select **Enable** to lock the panel control of all connected VE8900 / VE8950 devices. To unlock the panel of a single VE8900 / VE8950 device, press and hold the Down (-) button on the top panel for 3 seconds.

Note: The VE8900 / VE8950 device automatically locks its panel when it idles for 1 minutes.

- ◆ Installation Wizard: Click  on the top-right corner to open up the installation wizard. For details, see *Logging In and Configuring VE Manager*, page 21.

Click **Apply** for the settings to take effect on the connected VE8900 / VE8950 devices.

Transmitter Settings

The Transmitter tab displays the managed VE8900 / VE8950 transmitter devices and provides access to the settings.

To access transmitter settings, follow the steps below.

1. From the main screen, click , and then click the **Transmitter** tab. The managed VE8900 / VE8950 transmitters appear.

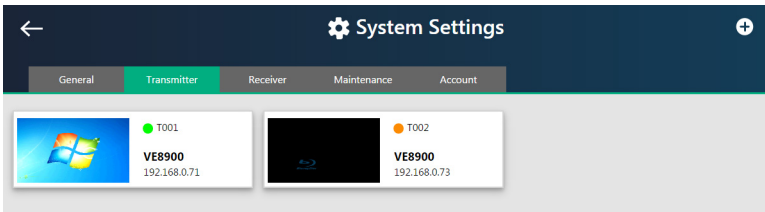

2. Move the cursor to a transmitter you wish to configure. A green arrow appears at the top right corner of the transmitter preview window.
3. Click the green arrow. A drop-down menu appears.

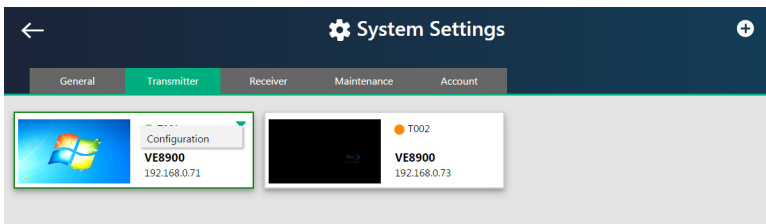

4. Click **Configuration**. This window appears.

 A screenshot of the 'T001 Configuration' window. The window title is 'T001' with a refresh icon. It contains several configuration fields:

- Name:** VE8900
- IP Address:** Radio buttons for DHCP, System Auto (selected), and Manual. A sub-window is open for Manual configuration with fields for IP Address (169.254.3.151), Subnet Mask, and Gateway.
- Audio In:** Radio buttons for HDMI and Analog (selected).
- EDID:** A dropdown menu set to 'Auto'.
- RS232 Baudrate:** A dropdown menu set to '115200'.

 At the bottom right, there are three buttons: 'Default' (in red), 'CANCEL', and 'SAVE' (in green).

5. Configure the settings as required.
 - ◆ **Name:** Click to rename the transmitter.
 - ◆ **IP Address:** Specifies how the transmitter obtains its IP address. By default, this field is set to **System Auto**.
 - ◆ **DHCP:** Select this option to have the IP address automatically assigned by a DHCP server.
 - ◆ **System Auto:** Select this option to have the IP address automatically assigned by the VE Manager.
 - ◆ **Manual:** Select this option to designate an IP address for the transmitter. Manually type the IP Address, Subnet Mask, and Gateway for the device.
 - ◆ **Audio In:** Select your audio signal type.
 - ◆ **EDID:** After receiving EDID information from the connected display, the VE8900T / VE8950T analyzes this information and sets up the input source. Select an EDID mode that suits your needs.
 - ◆ **Default:** Sets up the input to an optimum configuration based on ATEN's predefined list of EDID.
 - ◆ **Auto:** Sets up the input to the best resolution of the connected displays.
 - ◆ **Manual:** Sets up the input to user's configuration.
 - ◆ **Remix:** Sets up the input to an optimum resolution of the connected displays.
 - ◆ **RS-232 Baud Rate:** Select a suitable baud rate.
 - ◆ **Default:** Click to restore the transmitter's settings to default.
6. Click **SAVE** to keep the changes.

Receiver Settings

The Receiver tab displays managed VE8900 / VE8950 receiver devices and provides access to the settings.

To access receiver settings, follow the steps below.

1. From the main screen, click , and then click the **Receiver** tab. The managed VE8900 / VE8950 receivers appear.

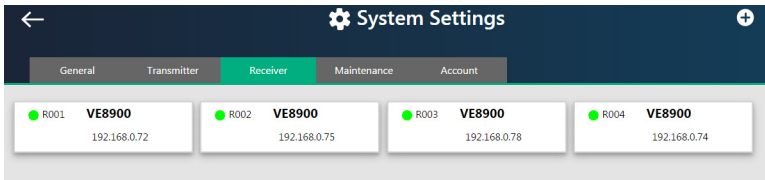

2. Move the cursor to a receiver you wish to configure. A green arrow appears at the top right corner of the receiver preview window.
3. Click the green arrow. A drop-down menu appears.

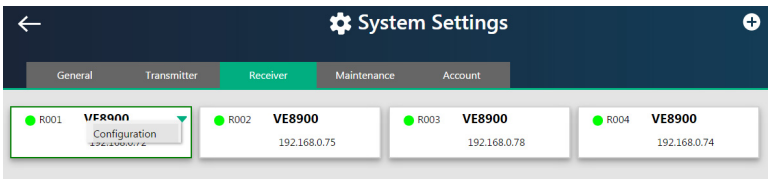

4. From the drop-down menu, click **Configuration**. This window appears.

The screenshot shows the 'R001 Configuration' window. It is divided into two main sections. The left section contains:

- Name: VE8900
- IP Address: Radio buttons for DHCP, System Auto, and Manual (selected). The Manual option is expanded to show:
 - IP Address: 192.168.0.72
 - Subnet Mask: 255.255.255.0
 - Gateway: 192.168.0.254
- Connected TX: T001

 The right section contains:

- IR/RS232: Radio buttons for Follow Video Path and Manual (selected). Manual is set to N/A.
- USB: Radio buttons for Follow Video Path and Manual (selected). Manual is set to N/A.
- Fast Switching: 1920x1080
- RS232 Baudrate: 115200

 At the bottom right, there are three buttons: 'Default' (in red), 'CANCEL', and 'SAVE'.

5. Configure the settings as required.

- ◆ **Name:** Type to name the receiver.
- ◆ **IP Address:** Specifies how the receiver obtains its IP address. By default, this field is set to **System Auto**.
 - ◆ **DHCP:** Select this option to have the IP address automatically assigned by a DHCP server.
 - ◆ **System Auto:** Select this option to have the IP address automatically assigned by the VE Manager.
 - ◆ **Manual:** Select this option to designate an IP address for the receiver. Manually type the IP Address, Subnet Mask, and Gateway for the device.
- ◆ **Connected Tx:** Defines the video source for this receiver.
- ◆ **IR/RS-232:** Sets the source for IR/RS-232 signals. By default, the IR and RS-232 are disabled (**Manual > N/A**).
 - ◆ **Follow Video Path:** Select this option to receive IR/RS-232 signals from the transmitter (**Connected Tx**) where the receiver obtains its video source.
 - ◆ **Manual:** Use this setting to select a different source for obtaining IR/RS-232 signals.
- ◆ **USB:** Sets the source for the connected USB devices.
 - ◆ **Follow Video Path:** Select this option to receive USB signals from the transmitter (**Connected Tx**) where the receiver obtains its video source.
 - ◆ **Manual:** Use this setting to select a different source for obtaining USB signals.
- ◆ **Fast Switching:** Click to define the resolution for fast switching.

Note: For best results, ATEN recommends setting this field to the same resolution with your video source and make sure this setting is identical on all VE8900 / VE8950 receivers.

- ◆ **RS-232 Baudrate:** Click to define the baud rate for the receiver.
 - ◆ **Default:** Click to restore the receiver's settings in this window to default.
6. Click **SAVE** to keep the changes.

Maintenance

The Maintenance tab allows you to upgrade device firmware, back up transmitter and receiver layouts, and restore devices to previously backed up settings.

Upgrading VE8900 / VE8950 Device Firmware

To upgrade the VE8900 / VE8950 device firmware, follow the steps below.

1. From the main screen, click , and click the **Maintenance** tab. This screen appears. The Firmware Upgrade section lists the detected transmitter and receiver devices, and their firmware versions.

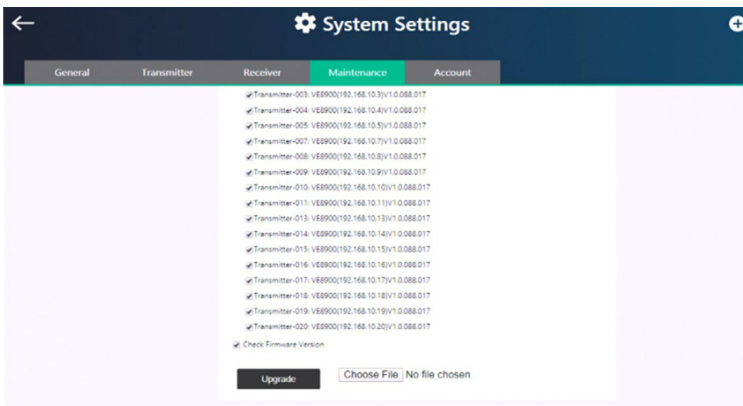

2. Click **Browse** to locate a previously saved firmware file.
3. Click to unselect any devices that do not require the upgrade.
4. By default, any upgrades that involve a version rollback will be ignored. To apply both upgrades and version rollbacks, unselect **Check Firmware Version**.
5. Click **Upgrade** to start upgrading.

Backing Up VE8900 / VE8950 Device Settings

You can export transmitter and receiver layouts for backup or migration purposes.

1. From the main screen, click , and then click the **Maintenance** tab. This screen appears.

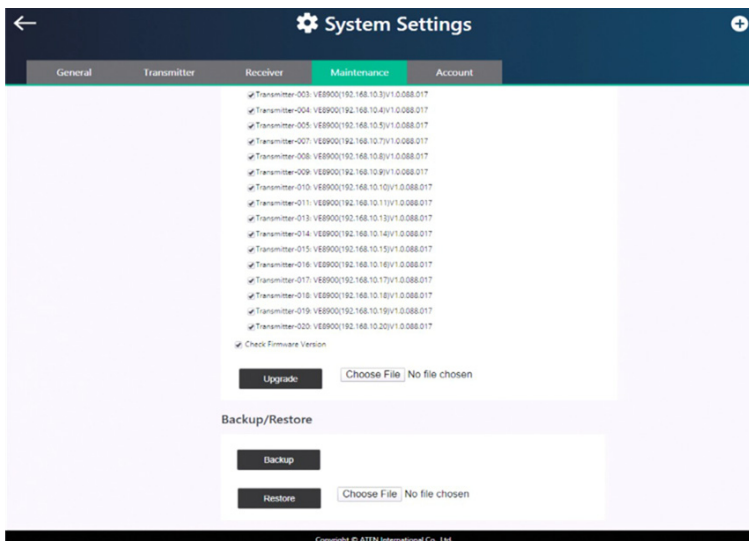

2. Click **Back up**. A confirmation message appears when the backup is complete.

Restoring VE8900 / VE8950 Device Settings

You can restore your VE Manager to a previously saved set of settings on transmitter and receiver layouts.

1. From the main screen, click , and then click the **Maintenance** tab. This screen appears.

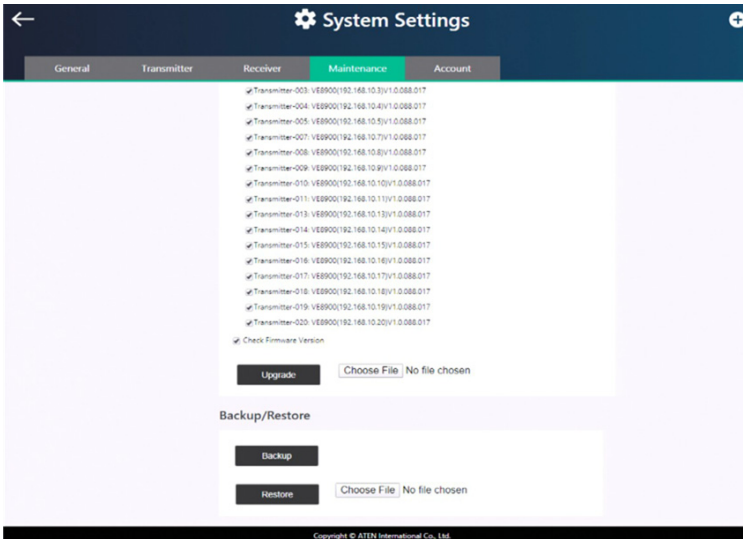

2. Click **Browse** to locate a previously saved settings file.
3. Click **Restore** to start overwriting the settings to the VE Manager. A confirmation message appears when the backup is complete.

Account Settings

VE Manager contains two account levels, the *Administrator* and the *User* level. The default passwords and privileges are detailed in the table below.

Account Level	Default Password	Privileges
Administrator	password	All settings
User	password	Source assignment and VE8900 / VE8950 receiver allocation on video wall layouts only

To change the default password, click  from the main screen, and then click the **Account** tab.

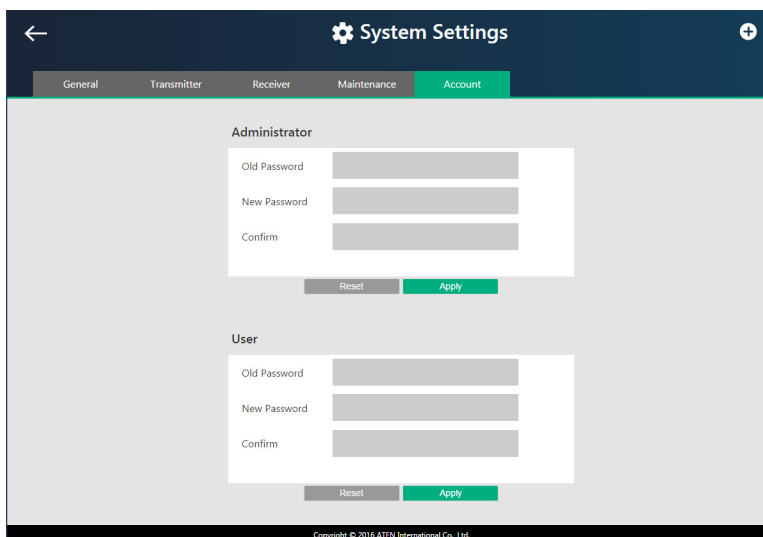

The screenshot displays the 'System Settings' application with the 'Account' tab selected. It features two sections for password management:

- Administrator:** Includes input fields for 'Old Password', 'New Password', and 'Confirm', with 'Reset' and 'Apply' buttons below.
- User:** Includes input fields for 'Old Password', 'New Password', and 'Confirm', with 'Reset' and 'Apply' buttons below.

At the bottom of the screen, the copyright notice reads: Copyright © 2016 ATEN International Co., Ltd.

Safety Instructions

General

- ◆ This product is for indoor use only.
- ◆ Read all of these instructions. Save them for future reference.
- ◆ Follow all warnings and instructions marked on the device.
- ◆ Do not place the device on any unstable surface (cart, stand, table, etc.). If the device falls, serious damage will result.
- ◆ Do not use the device near water.
- ◆ Do not place the device near, or over, radiators or heat registers.
- ◆ The device cabinet is provided with slots and openings to allow for adequate ventilation. To ensure reliable operation, and to protect against overheating, these openings must never be blocked or covered.
- ◆ The device should never be placed on a soft surface (bed, sofa, rug, etc.) as this will block its ventilation openings. Likewise, the device should not be placed in a built in enclosure unless adequate ventilation has been provided.
- ◆ Never spill liquid of any kind on the device.
- ◆ Unplug the device from the wall outlet before cleaning. Do not use liquid or aerosol cleaners. Use a damp cloth for cleaning.
- ◆ The device should be operated from the type of power source indicated on the marking label. If you are not sure of the type of power available, consult your dealer or local power company.
- ◆ The device is designed for IT power distribution systems with 230V phase-to-phase voltage.
- ◆ To prevent damage to your installation it is important that all devices are properly grounded.
- ◆ The device is equipped with a 3-wire grounding type plug. This is a safety feature. If you are unable to insert the plug into the outlet, contact your electrician to replace your obsolete outlet. Do not attempt to defeat the purpose of the grounding-type plug. Always follow your local/national wiring codes.
- ◆ Do not allow anything to rest on the power cord or cables. Route the power cord and cables so that they cannot be stepped on or tripped over.

- ◆ If an extension cord is used with this device make sure that the total of the ampere ratings of all products used on this cord does not exceed the extension cord ampere rating. Make sure that the total of all products plugged into the wall outlet does not exceed 15 amperes.
- ◆ To help protect your system from sudden, transient increases and decreases in electrical power, use a surge suppressor, line conditioner, or uninterruptible power supply (UPS).
- ◆ Position system cables and power cables carefully; Be sure that nothing rests on any cables.
- ◆ Never push objects of any kind into or through cabinet slots. They may touch dangerous voltage points or short out parts resulting in a risk of fire or electrical shock.
- ◆ Do not attempt to service the device yourself. Refer all servicing to qualified service personnel.
- ◆ If the following conditions occur, unplug the device from the wall outlet and bring it to qualified service personnel for repair.
 - ◆ The power cord or plug has become damaged or frayed.
 - ◆ Liquid has been spilled into the device.
 - ◆ The device has been exposed to rain or water.
 - ◆ The device has been dropped, or the cabinet has been damaged.
 - ◆ The device exhibits a distinct change in performance, indicating a need for service.
 - ◆ The device does not operate normally when the operating instructions are followed.
- ◆ Only adjust those controls that are covered in the operating instructions. Improper adjustment of other controls may result in damage that will require extensive work by a qualified technician to repair.

Rack Mounting

- ◆ Before working on the rack, make sure that the stabilizers are secured to the rack, extended to the floor, and that the full weight of the rack rests on the floor. Install front and side stabilizers on a single rack or front stabilizers for joined multiple racks before working on the rack.
- ◆ Always load the rack from the bottom up, and load the heaviest item in the rack first.
- ◆ Make sure that the rack is level and stable before extending a device from the rack.
- ◆ Use caution when pressing the device rail release latches and sliding a device into or out of a rack; the slide rails can pinch your fingers.
- ◆ After a device is inserted into the rack, carefully extend the rail into a locking position, and then slide the device into the rack.
- ◆ Do not overload the AC supply branch circuit that provides power to the rack. The total rack load should not exceed 80 percent of the branch circuit rating.
- ◆ Make sure that all equipment used on the rack – including power strips and other electrical connectors – is properly grounded.
- ◆ Ensure that proper airflow is provided to devices in the rack.
- ◆ Ensure that the operating ambient temperature of the rack environment does not exceed the maximum ambient temperature specified for the equipment by the manufacturer.
- ◆ Do not step on or stand on any device when servicing other devices in a rack.

Technical Support

International

- ◆ For online technical support – including troubleshooting, documentation, and software updates: <http://support.aten.com>
- ◆ For telephone support, See *Telephone Support*, page vi:

North America

Email Support		support@aten-usa.com
Online Technical Support	Troubleshooting Documentation Software Updates	http://www.aten-usa.com/support
Telephone Support		1-888-999-ATEN ext 4988

When you contact us, please have the following information ready beforehand:

- ◆ Product model number, serial number, and date of purchase
- ◆ Your computer configuration, including operating system, revision level, expansion cards, and software
- ◆ Any error messages displayed at the time the error occurred
- ◆ The sequence of operations that led up to the error
- ◆ Any other information you feel may be of help

Specifications

Function	VE8900R	VE8950R	VE8900T	VE8950T
Video Input				
Interfaces	N/A		1 x HDMI Type A Female (Black)	
Impedance	N/A		100 Ω	
Max. Distance	N/A		1.8 m	
Video Output				
Interfaces	1 x HDMI Type A Female (Black)		N/A	
Impedance	100 Ω		N/A	
Video				
Max. Data Rate	Average: 150 ~ 500Mbps		Average: 150 ~ 500Mbps	
Compliance	HDMI HDCP Compatible	HDMI (4K) HDCP Compatible	HDMI HDCP Compatible	HDMI (4K) HDCP Compatible
Max. Resolutions / Distances	Up to 1080p@100m (Cat 5e/6, point to point)	Up to 4K@100m (Cat 5e/6, point to point) *4K supported: 4096 x 2160 / 3840 x 2160 @ 30Hz (4:4:4)	Up to 1080p@100m (Cat 5e/6, point to point)	Up to 4K@100m (Cat 5e/6, point to point) *4K supported: 4096 x 2160 / 3840 x 2160 @ 60Hz (4:2:0) 4096 x 2160 / 3840 x 2160 @ 30Hz (4:4:4)
Audio				
Input	N/A		1 x HDMI Type A Female (Black) 1 x Mini Stereo Jack Female (Green)	
Output	1 x HDMI Type A Female (Black) 1 x Mini Stereo Jack Female (Green)		N/A	
Connectors				
Unit to Unit	2 x RJ-45 Female		1 x RJ-45 Female	
Control				
IR	1 x Mini Stereo Jack Female (Black)		1 x Mini Stereo Jack Female (Black)	
RS-232	Connector	1 x Terminal Block, 3 x Pole		1 x Terminal Block, 3 x Pole
	Baud Rate	19200		19200
	Data Bits	8		8
	Stop Bits	1, no parity and flow control		1, no parity and flow control
USB	2 x USB Type A Female (Black)		1 x USB Type B Female (White)	
Power				
Connectors	1 x DC Jack (Black) with locking		1 x DC Jack (Black) with locking	
Consumption	DC 5V, 4.2W (without USB peripheral device loading)	DC 5V, 4.6W (without USB peripheral device loading)	DC 5V, 3.2W	DC 5V, 3.3W

Function	VE8900R	VE8950R	VE8900T	VE8950T
Environmental				
Operating Temperature	0 - 40°C		0 - 40°C	
Storage Temperature	-20 - 60°C		-20 - 60°C	
Humidity	0 x 80% RH, Non-Condensing		0 x 80% RH, Non-Condensing	
Physical Properties				
Housing	Metal		Metal	
Weight	0.49 Kg (1.08 lb)		0.50 Kg (1.10 lb)	
Dimensions (L x W x H) with Bracket	14.02 x 12.30 x 3.06 cm (5.52 x 4.84 x 1.20 in.)		14.02 x 12.30 x 3.06 cm (5.52 x 4.84 x 1.20 in.)	
Dimensions (L x W x H) without Bracket	13.60 x 10.10 x 2.90 cm (5.35 x 3.98 x 1.14 in.)		13.60 x 10.10 x 2.90 cm (5.35 x 3.98 x 1.14 in.)	

Supported Browsers

Please see the table below for supported web browsers and the versions.

Web Browser	Supported Versions
Google Chrome	60.0.3112 or later
Mozilla Firefox	54.0.1 or later
Opera	46 or later

Limited Warranty

ATEN warrants its hardware in the country of purchase against flaws in materials and workmanship for a Warranty Period of two [2] years (warranty period may vary in certain regions/countries) commencing on the date of original purchase. This warranty period includes the LCD panel of ATEN LCD KVM switches. Select products are warranted for an additional year (see *A+ Warranty* for further details). Cables and accessories are not covered by the Standard Warranty.

What is covered by the Limited Hardware Warranty

ATEN will provide a repair service, without charge, during the Warranty Period. If a product is defective, ATEN will, at its discretion, have the option to (1) repair said product with new or repaired components, or (2) replace the entire product with an identical product or with a similar product which fulfills the same function as the defective product. Replaced products assume the warranty of the original product for the remaining period or a period of 90 days, whichever is longer. When the products or components are replaced, the replacing articles shall become customer property and the replaced articles shall become the property of ATEN.

To learn more about our warranty policies, please visit our website:
<http://www.aten.com/global/en/legal/policies/warranty-policy/>