



Introduction

Welcome	2
AdderLink XDIP features	4
Supplied items (per node)	5
Optional extras	6

Installation

Locations	7
Mounting	7
Connections	7
Computer connections	8
Video format conversion	9
Console connections	11
Audio connections	12
Link connection	12
Power connection	13

Configuration

Initial configuration	14
Navigating the configuration wizard, OSD and Admin menu	14
To use the configuration wizard	14
To add a new transmitter	18
Restoring a node	20

Admin menus	21
Receiver node settings	21
General Settings page	21
OSD Settings page	22
Manage Ports page	23
Advanced page	24
Software Upgrade page	26
Setup Channels page	27
Transmitter node settings	27
General Settings page	27
Manage Ports pages	28
Advanced pages	29
Software Upgrade page	30

Operation

Switching channels	31
Switching channels from a receiver	31
Switching channels from an external system	32
Indicators	33

Further information

Getting assistance	34
Appendix 1 - IGMP	35
Appendix 2 - Layers	36
Appendix 3 - Link cable interference protection	37
Appendix 4 - XDIP API	38
Appendix 5 - Open source licenses	40

Index

Introduction



WELCOME

Thank you for choosing the AdderLink XDIP extender nodes. At their simplest, AdderLink XDIPs are high resolution, low latency digital KVM extenders which will operate just as easily across a direct 100 meter CATx connection as they will across your standard 1GbE local network. However, there's much more to them than that.

Many hosts, one console

XDIPs can form what might be termed a *Distributed KVM switch*, where you authorize a single XDIP receiver to access up to sixteen separate XDIP transmitters and their connected PC host systems:

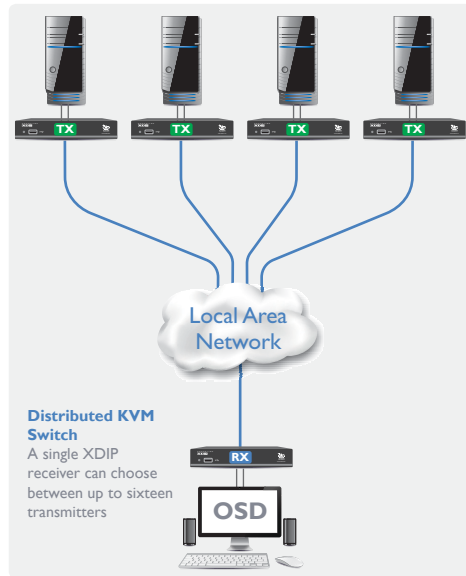

Multiple consoles, one host

Alternatively, a different grouping of XDIPs can form a 'KVM Sharer' to allow up to 256 receivers to access and control the resources of a single PC host system:

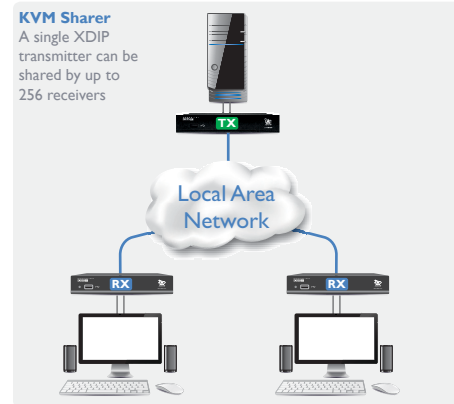

Remote controlled matrix configuration - see next page

Transmitter or receiver? Your call

Every XDIP node arrives in *Start of Life* (SoL) mode: it's up to you to choose whether it becomes a transmitter or a receiver. This ensures that your small stock of nodes can efficiently meet your current requirements - and then be easily redistributed, in any order, to satisfy future issues too.

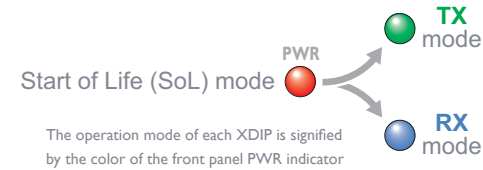

All HD video welcome

HDMI is the native video port on each node, however, using suitable third party converters you can connect DVI, dual-mode DisplayPort® (DP++) or VGA signals at either end of the links:

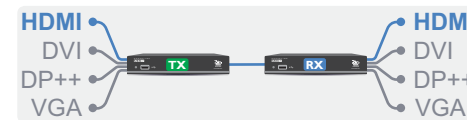

Power to perform: POE or adapter

Efficiency is key to XDIP operation, sufficiently so that each node can comfortably function using only the Power over Ethernet (PoE) capabilities of your network. Where that's not an option, we also supply optional power adapters for local mains operation.

Feed through for flexibility

Every XDIP node features a *Feed through* port. This allows you to add a local console that can access both nearby and distant resources. When the local console is placed on an XDIP receiver, it will operate as its own KVM switch. Alternatively, when the local console is attached to an XDIP transmitter, it will also act as a video splitter:

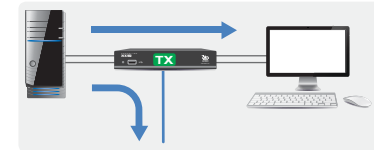

A combined application of the *Feed through* and *KVM sharer* features could be used, for instance, to serve a lecture theater:

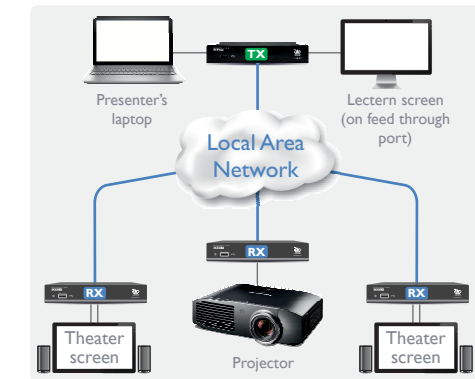

INSTALLATION

CONFIGURATION

OPERATION

FURTHER INFORMATION

INDEX

continued

Remote controlled matrix

XDIPs can also form an audio-visual matrix where multiple receivers access content from a choice of transmitters - all under external control. Such configurations are useful in distributed signage applications where a control system coordinates multiple displays (up to 256) and determines how each one derives its digital content.

There are two methods for remotely controlling an XDIP matrix:

- Method 1 - Using third party controller system, such as those supplied by Crestron™, AMX™ and many others, to issue commands through our RESTful API (see page 38), or
- Method 2 - Using the browser on a connected PC to access the receivers and using the resulting OSD menu (see page 32).

IMPORTANT: When using either method, you must first enable the remote control functionality on each receiver (this option is disabled by default).

See *Receiver > Advanced page* on page 24.

To ensure ease of configuration with third party controllers, the XDIP system is provided with a full REST API.

New features have been added to XDIP units to enable remote control matrix operation:

- Each XDIP module can be assigned a static IP address as well as its main (DHCP-provided) dynamic address, so that external systems have a separate, consistent control pathway.
- Each XDIP module has separate admin and access passwords; the latter providing selective access to content and switching controls.
- Full third-party switching support provided by REST API via the network connection. The YAML file for the API can be found at:

<https://support.adder.com/tiki/tiki-index.php?page=XDIP%3A+Using+the+API>

Remote controlled matrix

An external control system or connected PC can determine how each receiver should derive its content, from a choice of up to eight transmitters.

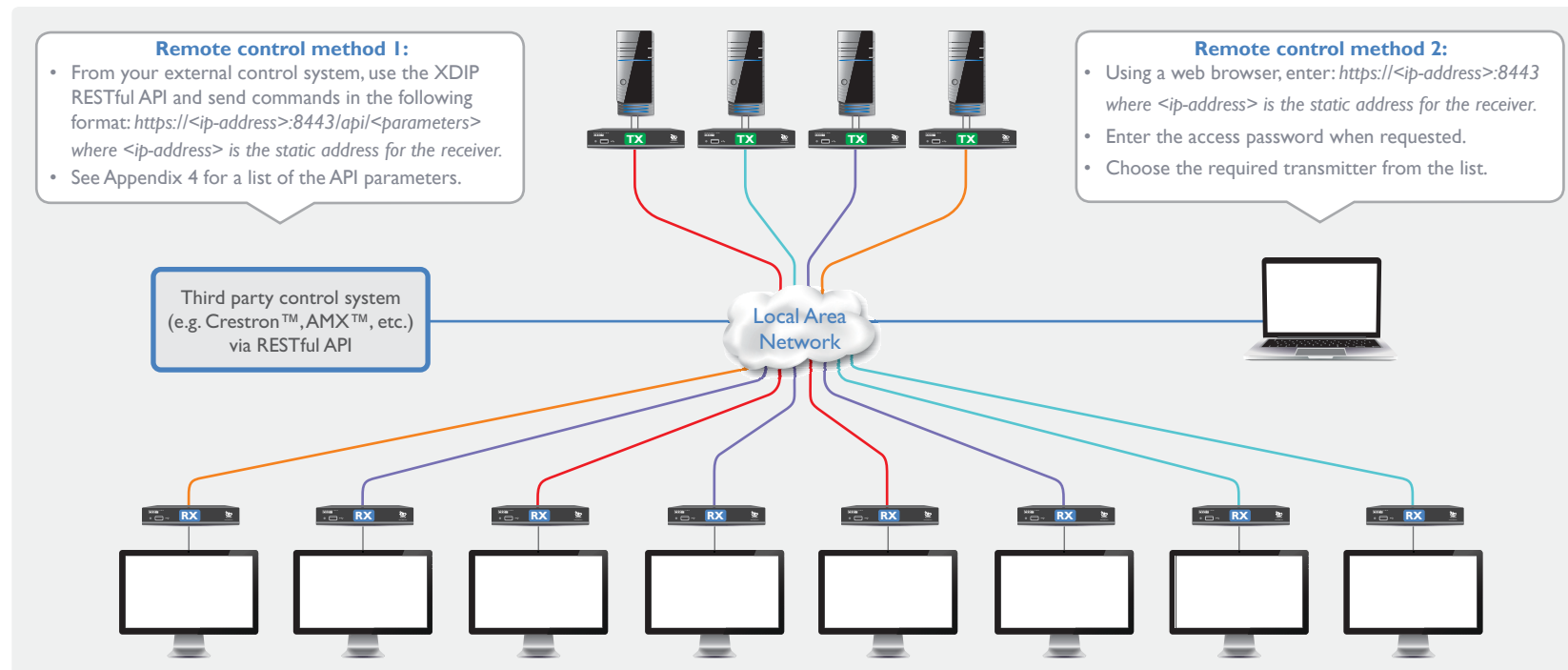

For details of the XDIP Public REST API, see [Appendix 4 - XDIP API](#).

Note: The API control is contained within each receiver. Receivers operate as separate entities and they are all controlled independently.

ADDERLINK XDIP FEATURES

AdderLink XDIP nodes are contained within slimline metal casings measuring just 169 x 112 x 31mm.

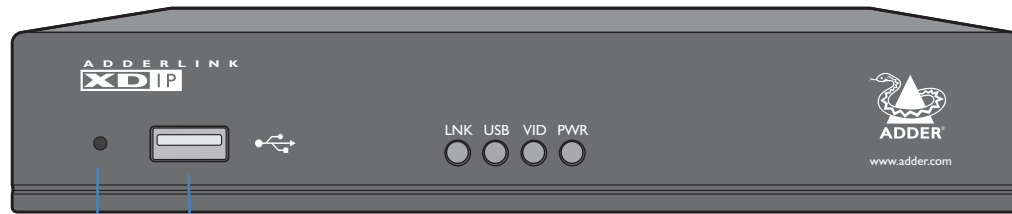

Recessed reset button
See "Restoring a node" on page 20.

USB port
Available for console use on receiver and transmitter nodes.

Status indicators
These provide visual confirmation of various system functions. See [Indicators](#) for further details.
LNK - indicates the presence of a valid data link.
USB and **VID** - indicate active USB and video connections.
PWR - indicates the presence of input power (the color also indicates overall mode: **TX**: Green, **RX**: Blue, **Start of Life**: Red, **Recovery mode**: Yellow).

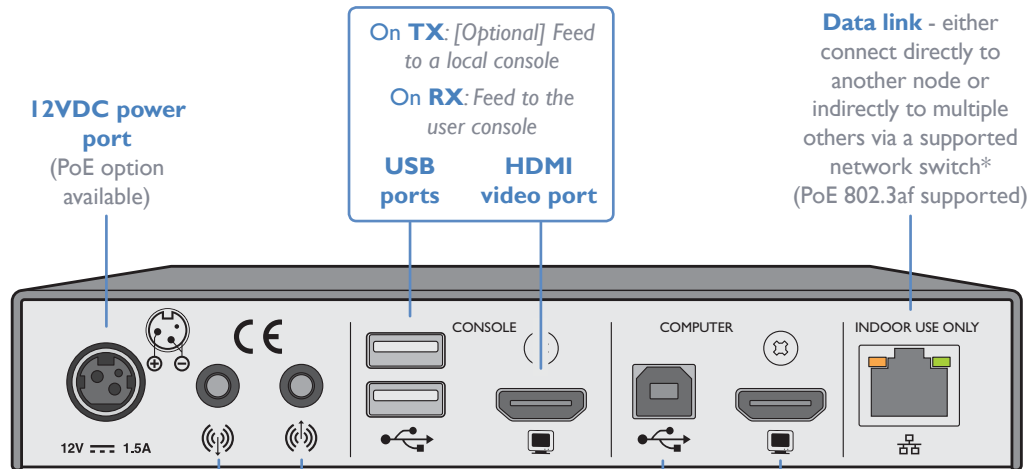

12VDC power port
(PoE option available)

On TX: [Optional] Feed to a local console
On RX: Feed to the user console
USB ports **HDMI video port**

Data link - either connect directly to another node or indirectly to multiple others via a supported network switch* (PoE 802.3af supported)

Audio line out jack **Audio line in jack**

USB port **HDMI video port**
On TX: Link to the main computer
On RX: [Optional] Link to a local computer

- * The network switch used must:
- Support 1Gb transfer rates.
 - Support [IGMP](#) (Internet Group Management Protocol) to at least level 2 (preferably level 3).
 - Have [IGMP Fast Leave](#) and [IGMP Snooping](#) enabled.

INSTALLATION

CONFIGURATION

OPERATION

FURTHER INFORMATION

INDEX

SUPPLIED ITEMS (per node)

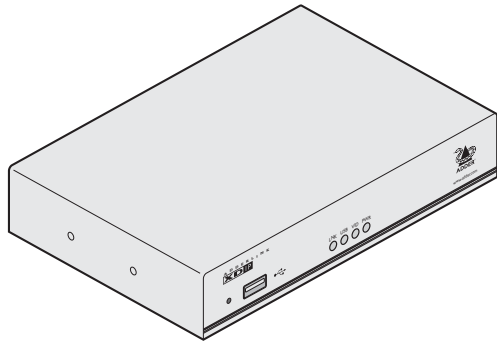

AdderLink XDIP node

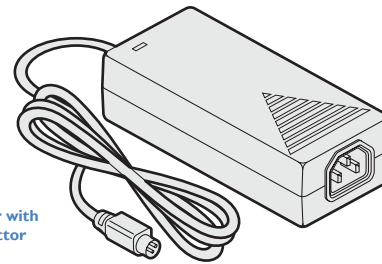

Power adapter with locking connector

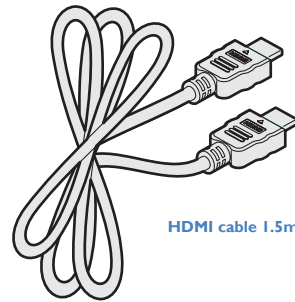

HDMI cable 1.5m

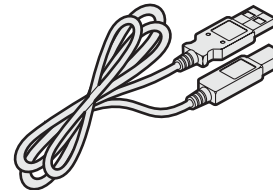

USB cable 2m (type A to B)

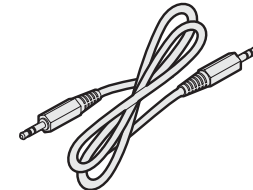

Audio cable 3m (3.5mm stereo jacks)

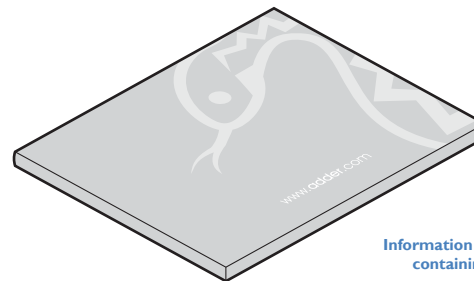

Information wallet containing:
Quick setup guide
Eight self-adhesive rubber feet
Safety document

OPTIONAL EXTRAS

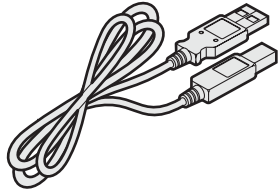

USB cable 2m (type A to B)
Part number:VSC24

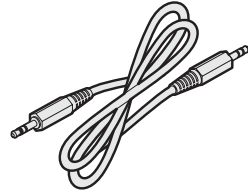

Audio cable 2m (3.5mm stereo jacks)
Part number:VSC22

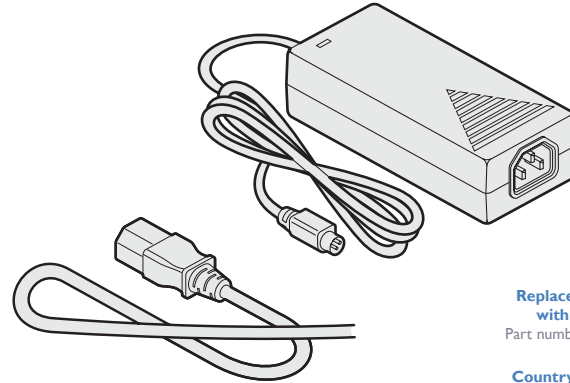

Replacement power adapter with locking connector
Part number: PSU-IEC-12VDC-1.5A

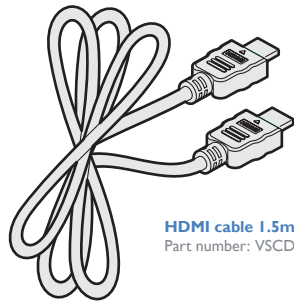

HDMI cable 1.5m
Part number: VSCD15

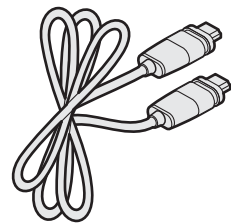

Lockable HDMI cable 1.5m
Part number:VSCD12

- Country-specific power cords**
- CAB-IEC-AUS (Australia)
 - CAB-IEC-EURO (Central Europe)
 - CAB-IEC-UK (United Kingdom)
 - CAB-IEC-USA (United States)
 - CAB-IEC-JAPAN (Japan)

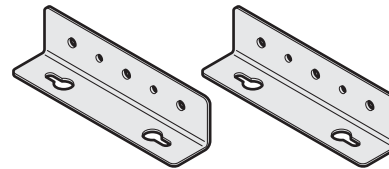

Wall/desk mounting kit (plus screws)
Part number: RMK10

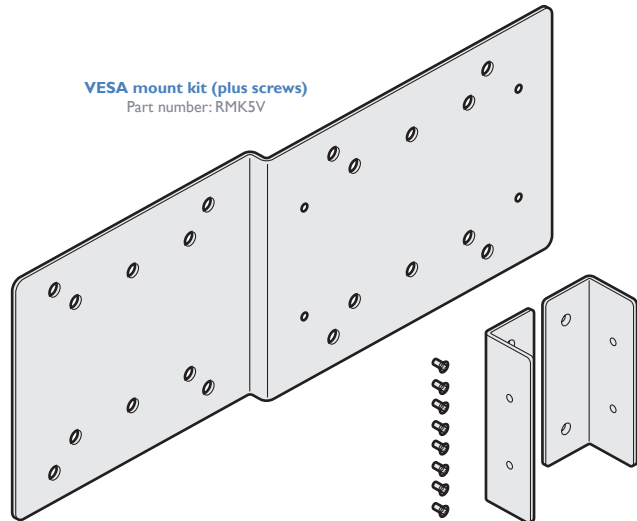

VESA mount kit (plus screws)
Part number: RMK5V

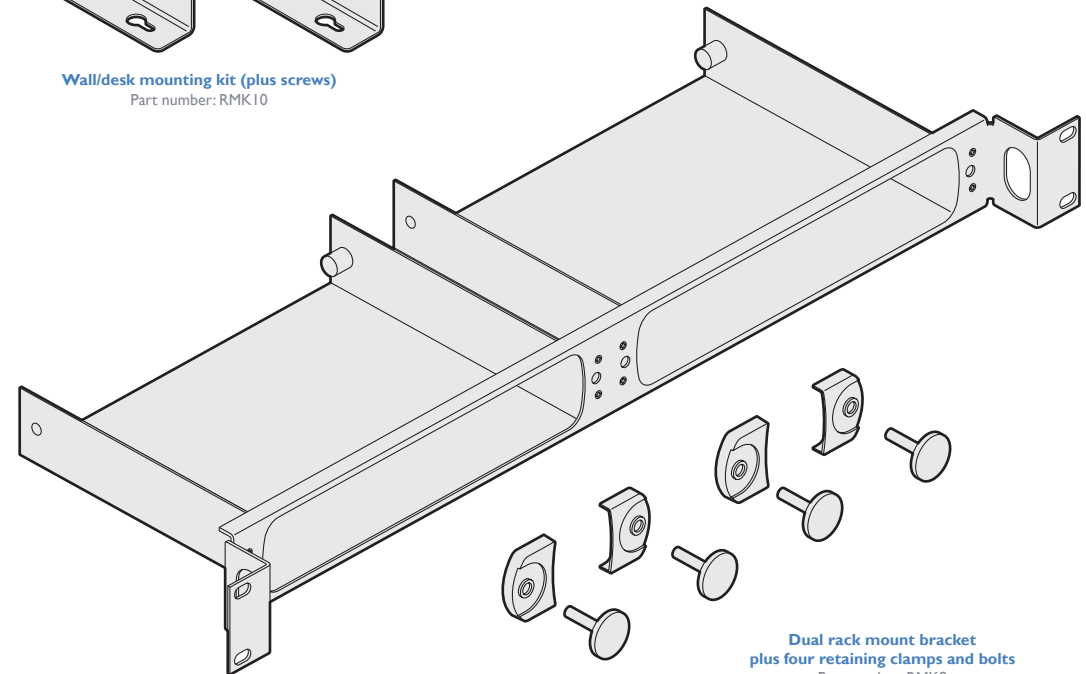

Dual rack mount bracket plus four retaining clamps and bolts
Part number: RMK8

LOCATIONS

Please consider the following important points when planning the position of the AdderLink XDIP nodes:

- Situate the transmitter node close to the system to which it will be connected and near to a source of mains power (if powering will not take place via PoE through the network cable). Place the receiver node in similar close proximity to the peripherals that it will connect with, plus a source of mains power.
- Consult the precautions listed within the [Safety information](#) section.
- Connections do not need to be carried out in the order given within this guide, however, where possible connect the *power in* as a final step.

MOUNTING

Before you begin making connections to the AdderLink XDIP nodes, it is advisable to first mount the nodes in place, either:

- On a horizontal surface using the supplied self adhesive feet, or
- On a vertical surface using the optional wall/desk mounting kit, or
- Within an optional rack mount bracket.

CONNECTIONS

Connections to each node will be determined by the nature of your installation as well as their intended transmitter or receiver designations.

All connections are grouped into five main areas:

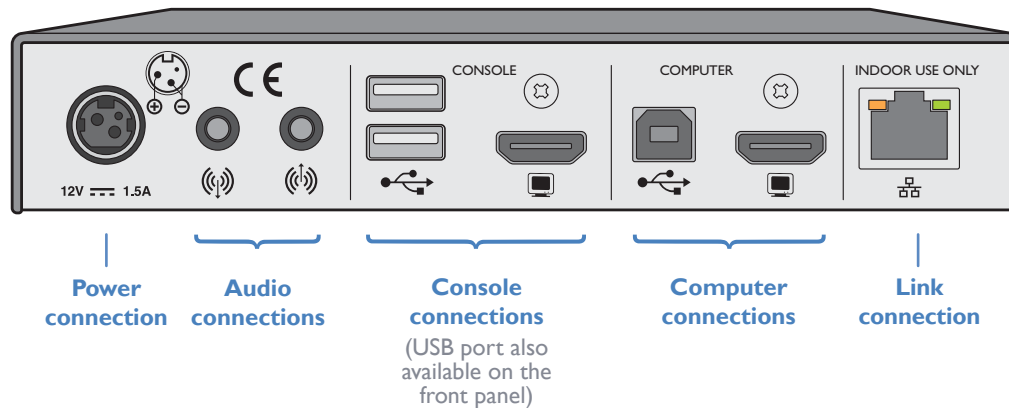

The pages that follow discuss the various connections.

Computer connections

Computer connections are always made at the transmitter node, but can also optionally be made at the receiver node, where channel switching between local and remote computer sources is required.

Notes:

- When a local computer is connected to a receiver node, it can only be accessed from that receiver, no other receivers can gain access to it.
- Video resolutions up to 1920 x 1200 @ 60Hz are supported.
- HDMI audio is not supported; please use the audio in/out ports to transfer audio signals.

To make computer connections

1 Insert the supplied HDMI cable between the HDMI video socket (in the **COMPUTER** section) and the video output port on the computer.

HDMI offers the great advantage that it is a straightforward task to convert its signals to and from other common video formats (DisplayPort, DVI and VGA) - See page 9.

2 Insert the supplied USB type A to type B cable between the USB socket (in the **COMPUTER** section) and a vacant USB port on the computer.

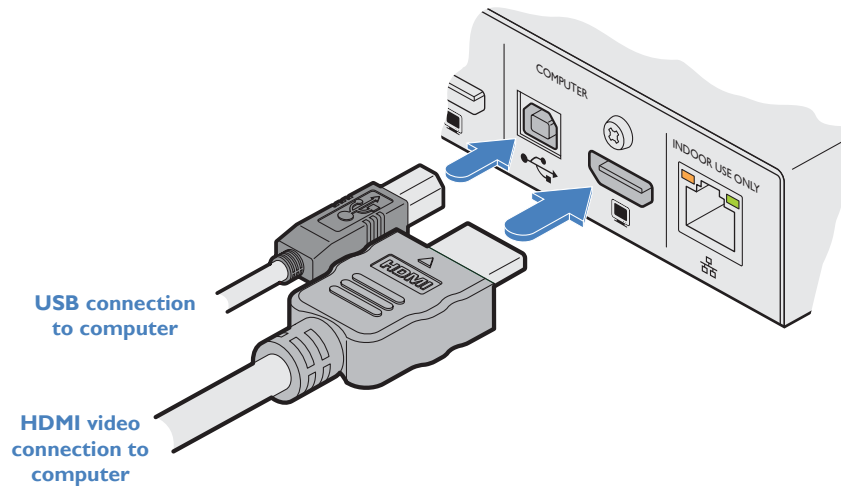

Video format conversion

One of the many advantages offered by the HDMI (High Definition Multimedia Interface) standard is the ease with which it can be converted into- and out of- numerous other video formats, including single link DVI-D, DisplayPort and VGA (see next page).

Note: HDMI conversion cables and adapters (apart from the Adder DVA) are not available from Adder, but are widely sold elsewhere.

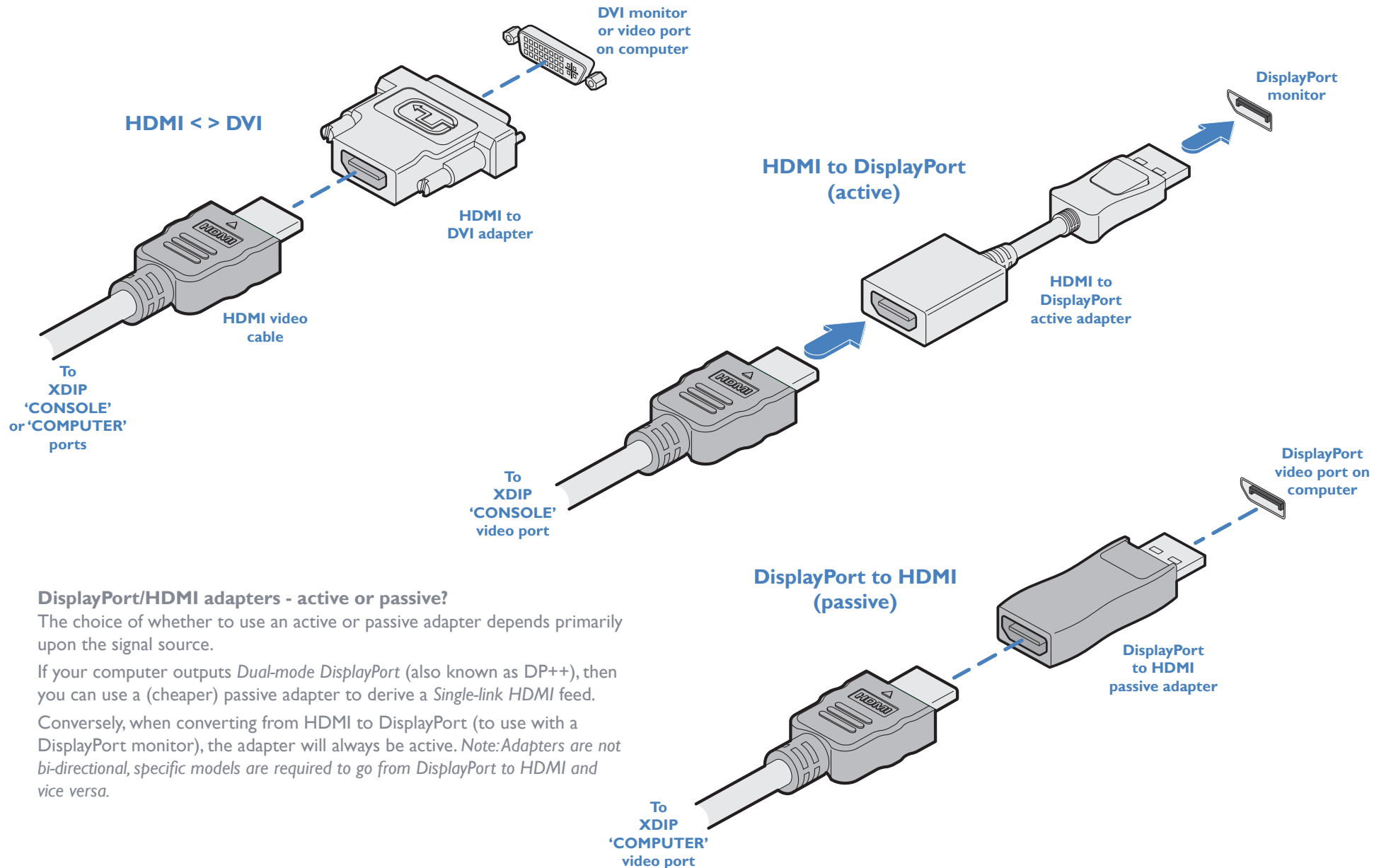

DisplayPort/HDMI adapters - active or passive?

The choice of whether to use an active or passive adapter depends primarily upon the signal source.

If your computer outputs *Dual-mode DisplayPort* (also known as DP++), then you can use a (cheaper) passive adapter to derive a *Single-link HDMI* feed.

Conversely, when converting from HDMI to DisplayPort (to use with a DisplayPort monitor), the adapter will always be active. *Note: Adapters are not bi-directional, specific models are required to go from DisplayPort to HDMI and vice versa.*

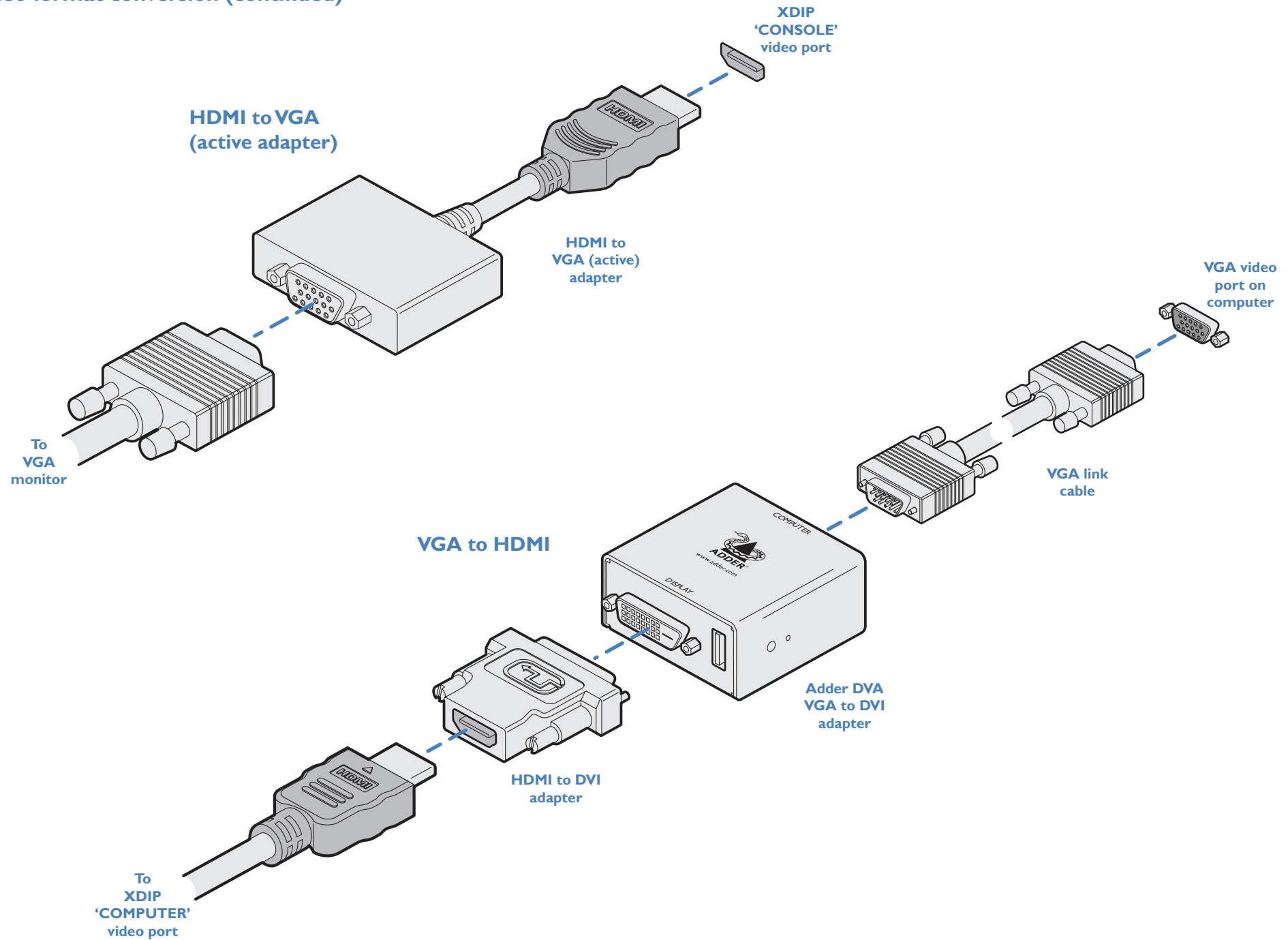

Console connections

Console connections (video monitor and/or USB peripherals) are always made at the receiver node, but can also optionally be made at the transmitter node, if local control (or monitoring) of the computer is required in addition to remote control.

Notes:

- Video resolutions up to 1920 x 1200 @ 60Hz are supported.
- HDMI audio is not supported; please use the audio in/out ports to transfer audio signals.

To make console connections

1 Insert the supplied HDMI cable between the HDMI video socket (in the **CONSOLE** section) and the video port on your monitor.

HDMI offers the great advantage that it is a straightforward task to convert its signals to and from other common video formats (DisplayPort, DVI and VGA) - See page 9.

2 Connect the USB leads from your mouse and keyboard to the two sockets on the rear panel. The single socket on the front panel is also available (all three USB ports operate in the same manner).

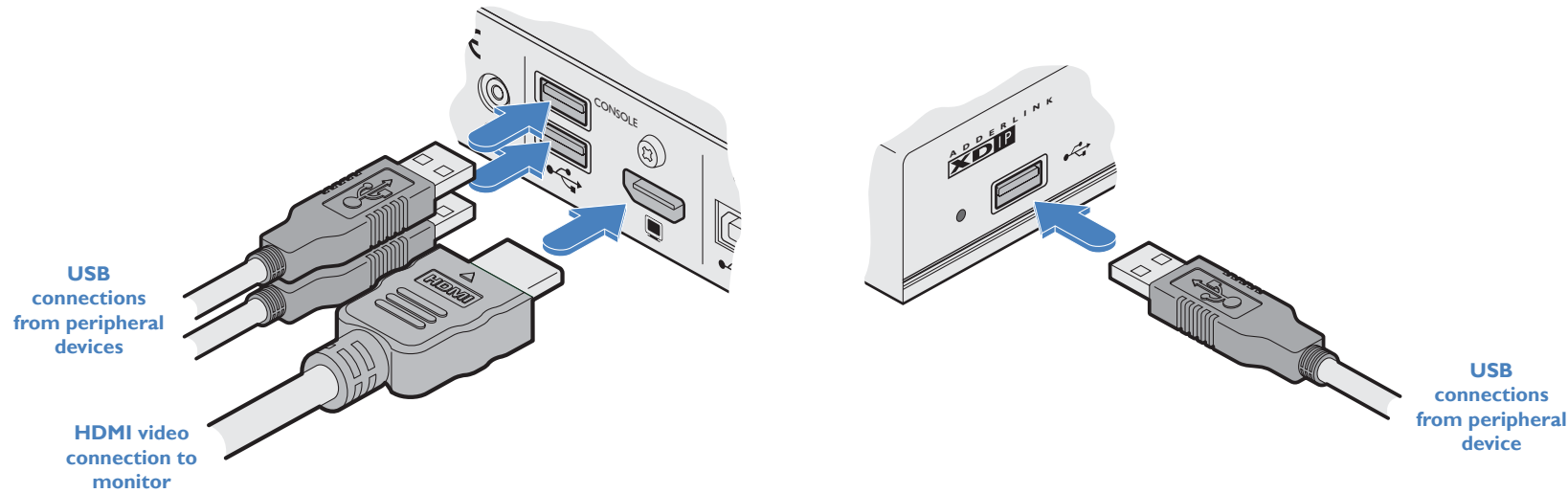



Audio connections

The transmitter and receiver nodes can transfer CD-quality stereo audio (16-bit sampling at 48kHz) in both directions. Headphones are supported up to 32 Ohms impedance.

Note: HDMI audio is not supported. Audio transfer is handled exclusively by the audio in/out ports.

To make audio connections

- 1 Connect your audio input (e.g. line out from the local computer, etc.) to the audio input (right hand) 3.5mm socket labeled  on the rear panel.
- 2 Connect your audio output (e.g. speakers or headphones, etc.) to the audio output (left hand) 3.5mm socket labeled  on the rear panel.

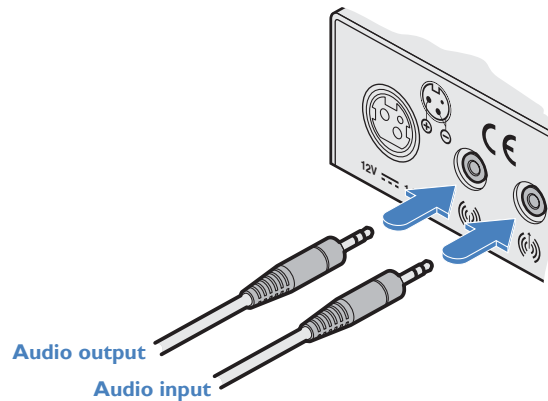

Link connection

As required, links between nodes can be made in two main ways, either:

- Directly between two nodes, using a single cable up to 100 meters in length, Minimum cable specification: CAT5e, S/FTP preferred, or
- Via a network switch to allow interaction between receiver/transmitter combinations.

Minimum network switch specifications:

- 1 Gb transfer rates.
- [IGMP](#) (Internet Group Management Protocol) to at least level 2 (preferably level 3) in order to allow efficient multicasting while keeping network bandwidth low.
- IGMP Fast Leave and IGMP Snooping must be enabled.

Optional network switch specification:

- PoE 802.3af - The nodes also support the Power over Ethernet standard to allow operation without separate power adapters when used with a supporting network switch.

To make a link connection

- 1 Insert a standard network cable into the socket on the far right of the rear panel.
- 2 Connect the other end of the cable either directly to another node, or to a suitable network switch.

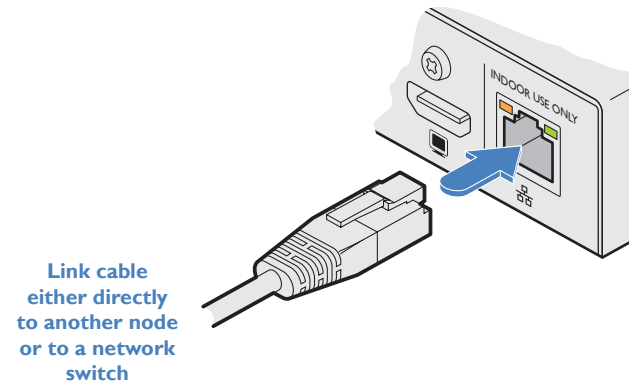

Power connection

Each node can be powered using its supplied power adapter or alternatively via the Ethernet link connection, when used with network switches which support the PoE 802.3af standard. The power adapters supplied with the nodes use locking-type plugs to help prevent accidental disconnections; please follow the instructions shown on the right when disconnecting a power adapter.

To connect the power adapter

- 1 Attach the output plug of the supplied power adapter to the power input socket on the left side of the rear panel. As you insert the plug, pull back slightly on the outer body to assist the locking mechanism until the plug is fully inserted.

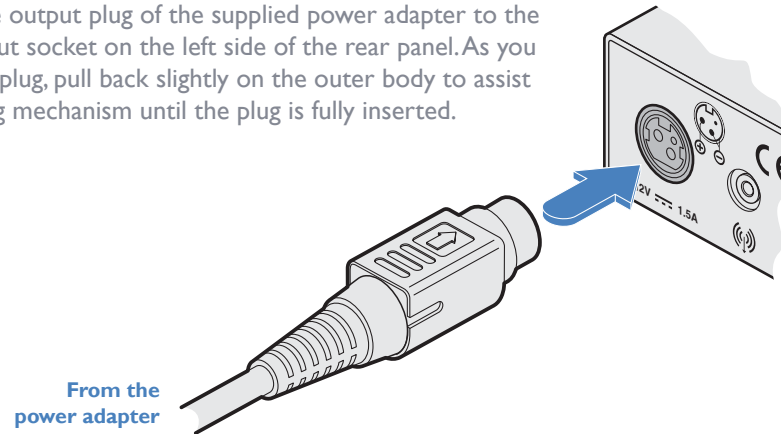

- 2 Insert the IEC connector of the supplied country-specific power cord to the socket of the power adapter.

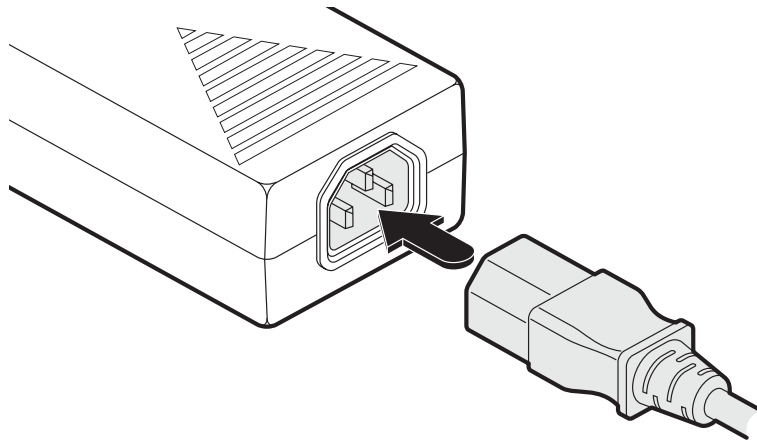

- 3 Connect the power cord to a nearby mains supply socket.

To disconnect the power adapter

- 1 Isolate the power adapter from the mains supply.
- 2 Grasp the outer body of the power adapter plug where it connects with the node.
- 3 Gently pull the body of the outer plug away from the node. As the body of the plug slides back, it will release from the socket and you can fully withdraw the whole plug.

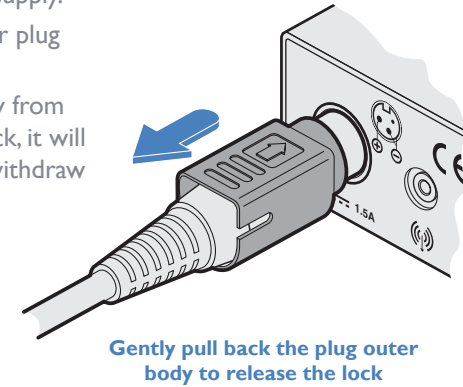

IMPORTANT: Please read and adhere to the electrical safety information given within the [Safety information](#) section of this guide. In particular, do not use an unearthed power socket or extension cable.

Note: Both the nodes and the power supplies generate heat when in operation and will become warm to the touch. Do not enclose them or place them in locations where air cannot circulate to cool the equipment. Do not operate the equipment in ambient temperatures exceeding 40 degrees Centigrade. Do not place the products in contact with equipment whose surface temperature exceeds 40 degrees Centigrade.

INITIAL CONFIGURATION

To streamline the initial installation procedure, AdderLink XDIP nodes use a configuration wizard to guide you through the necessary stages. For the simplest installations, this may be all that is necessary to completely tailor the nodes to your requirements. However, for more complicated installations you may also need to access the main Admin menu (see page 21) once the initial configuration is complete.

AdderLink XDIP configuration is primarily driven via the receiver(s). During the initial configuration and subsequent post-installation alterations, a transmitter can be configured via a receiver, but not vice versa. Also, one receiver cannot configure another receiver. Where two or more receiver nodes will be required, run the wizard from the first receiver node and, once complete (including all transmitter nodes), move to the console of the next required receiver node and run the configuration wizard again from there. Transmitters configured in the first run can be associated with multiple receivers, as required.

Navigating the configuration wizard, OSD and Admin menu

The AdderLink XDIP user interface has been carefully designed to be easily navigated by either mouse, keyboard or a combination of both.

When using the mouse, you merely need to point and click on screen items. As the mouse hovers over a screen item, if it is clickable it will become highlighted.

When using the keyboard to navigate, use the following keys:

- **Tab key** - To move forward between sections.
- **Shift + Tab keys** - To move backward between sections.
- **Arrow keys** - To change between the options within a section.
- **Enter key** - To select the highlighted option.
- **Esc key** - To exit the current page.

On a receiver node, to display the OSD:

- Press CTRL + ALT + C *

Once the OSD is displayed, to enter the Admin menu:

- Select the  icon in the top right corner of the page.

To view explanatory text about the page that you are viewing:

- Click the  icon in the top right corner of the page.

See page 31 for more details about keyboard navigation during operation.

* Note: The standard hotkey combinations can be changed. See page 22.

To use the configuration wizard

Note: If you are creating a transmitter to add into an existing installation, skip to page 18.

- 1 Connect your various AdderLink XDIP nodes as discussed in the Installation section.
- 2 Power on all nodes. Nodes that are currently in their *Start of Life* state will show their front panel PWR indicators in red (configured transmitters show green while receivers show blue). To return a node to its Start of Life state, you need to Restore it, see page 20.
- 3 Using a monitor, keyboard and mouse connected to the *Console* ports of an intended receiver node, you should see the following opening page:

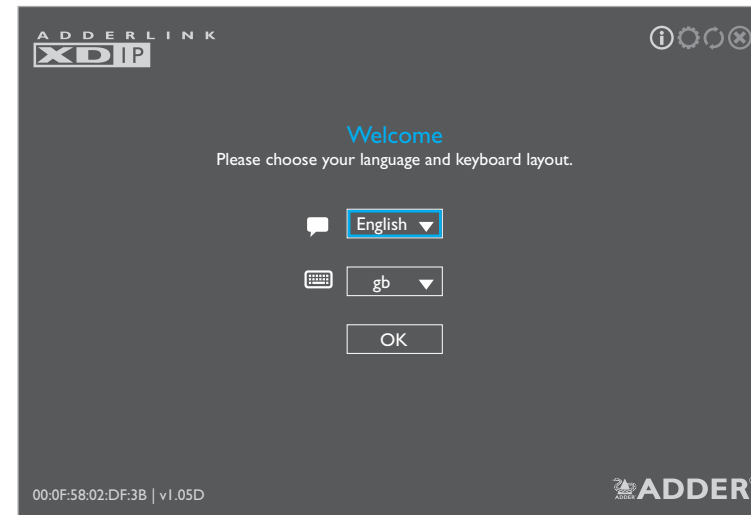

Note: The node's PWR indicator should be red at this stage. If not, restore the node to its default settings (see page 20).

- 4 If necessary, change the language and keyboard layout.
- 5 Click OK to continue.

continued

INITIAL CONFIGURATION (continued)

You will now be given a choice of turning this *Start of Life* node into either a receiver or a transmitter:

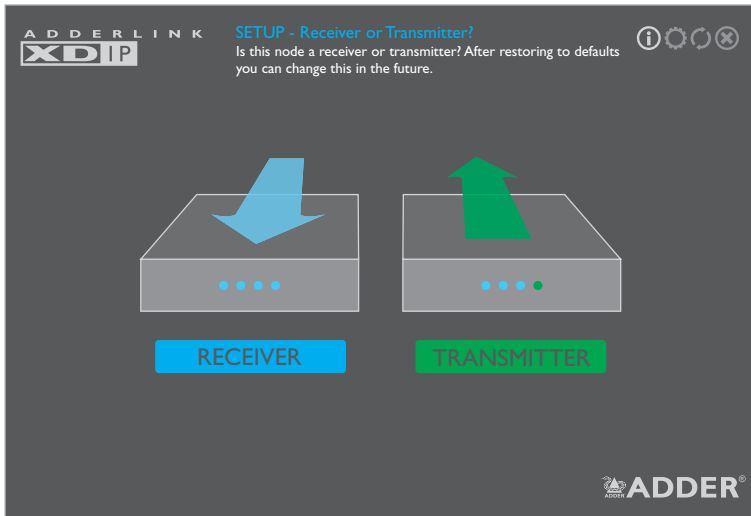

Note: When using the configuration wizard to create a full installation, it is quicker and more efficient to configure all transmitters via a node that will become a receiver, rather than configuring each of the intended transmitters separately.

6 Choose the required setting:

- If you are setting up a mixture of receiver(s) and transmitter(s), click the RECEIVER option.
- If you are creating a transmitter to add into an existing installation, click the TRANSMITTER option. See page 18.

If you chose the RECEIVER option, you will now be given the opportunity to enter details for the node to which your console peripherals are currently connected:

7 Enter the details for this receiver, including the admin password (required to administer the configuration details) and an access password (required for user access). The *Computer Name/Description* fields refer to a local computer connected directly to this receiver, if present.

Note: Passwords can be left blank, but this is not recommended.

8 Click OK.

continued

INITIAL CONFIGURATION (continued)

You will now see a list of all discovered nodes. If an entry shows **SoL** (*Start of Life*) then it is unconfigured (that node's PWR indicator will also show red). Otherwise, any discovered transmitter node, that is already configured, will show **TX**:

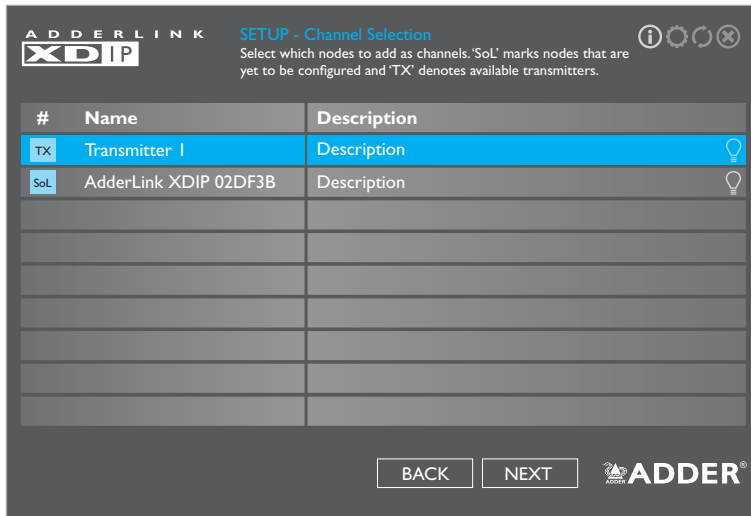

Notes

- If you are adding several nodes at once and need to identify a particular node, click the icon to flash the front panel indicators of the chosen node in the list.
- If nodes have been added since displaying the list, click the icon to refresh the list.

9 Click an entry marked **SoL** to configure it as a transmitter:

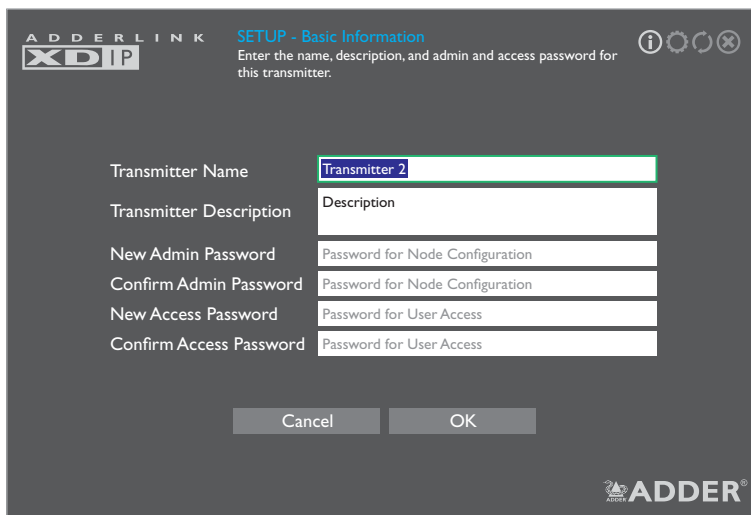

10 Enter the details for this transmitter, including two separate passwords:

- The *Admin Password* is required to administer the configuration details only,
- The *Access Password* allows you to restrict who is allowed to connect to this transmitter. When the Access Password is set, a user will be prompted to enter it when first attempting to add this transmitter node to their receiver node's channels list; if the Access Password is left blank, there will be no access restrictions.

Note: The Name and Description fields for each entry cannot be left blank.

11 Click OK. The discovered nodes will be again listed, showing any changes you have made to the name(s) and description(s):

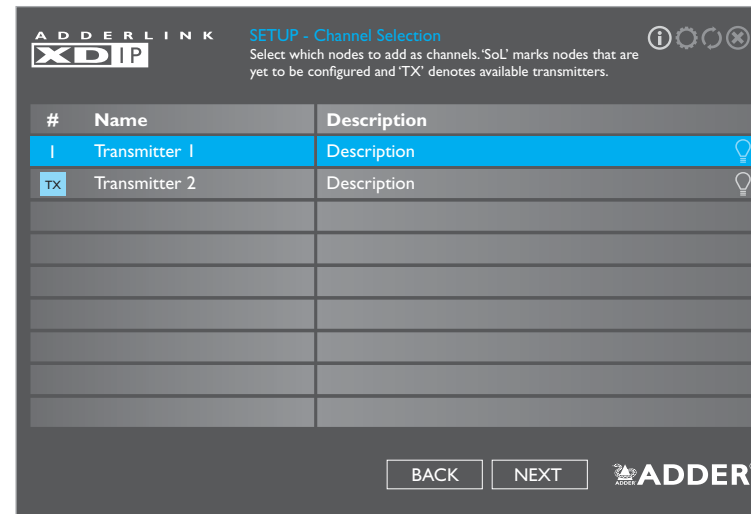

12 Repeat steps 9 to 11 for each listed **SoL** node.

13 Ensure that all the transmitters (8 maximum), to which you wish to connect from this receiver, show a number in the left hand column. If an entry shows **TX**, it is yet to be connected. Click on the entry to connect it with this receiver; if an access password is set on the transmitter, you will be asked to enter it. Once successfully connected, the **TX** for the entry will change to a number.

14 When all transmitters have been connected, click NEXT.

continued

INITIAL CONFIGURATION (continued)

15 You can now optionally change the order of transmitters in the channel list. Click, hold and drag an entry to the required slot:

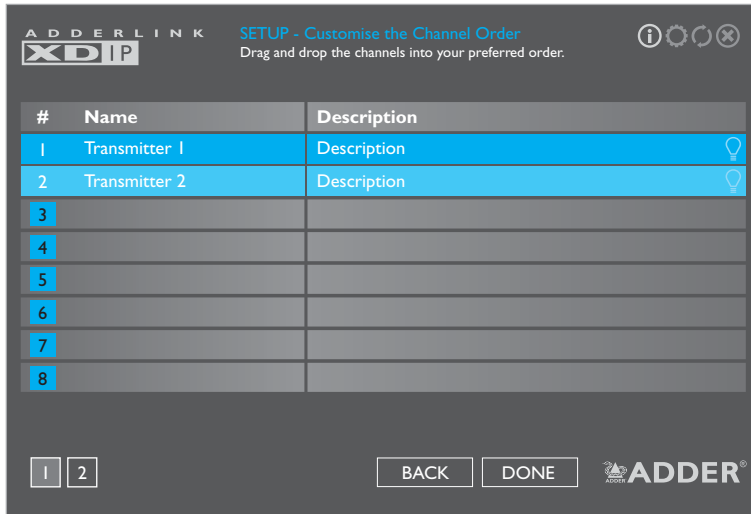

16 When all transmitters are in the required order, click DONE.

17 The receiver will now show the Channel List:

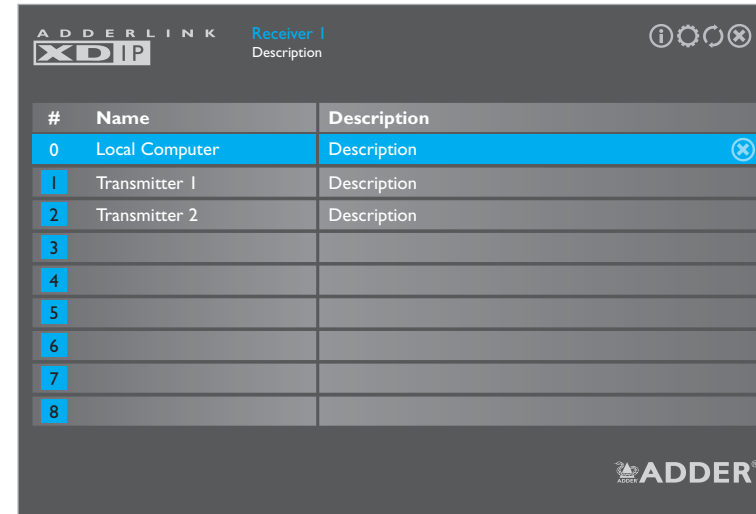

From here you can choose between a local computer (if connected to your receiver) or any of the associated transmitters. See page 31 for details about operation.

INITIAL CONFIGURATION (continued)

To add a new transmitter

Use this procedure to configure a new *Start of Life* node into a transmitter for inclusion within an existing installation:

- 1 Connect your console devices (video monitor, USB keyboard and/or mouse) plus power input to the new *Start of Life* node (as discussed in the Installation section).
For this procedure the new node can be configured either in isolation or fully linked into your XDIP installation, as required.
- 2 You should see the following opening page:

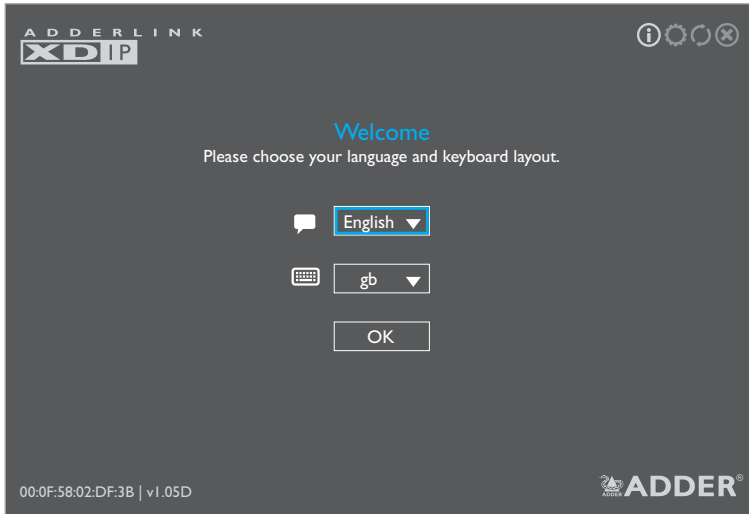

- 3 If necessary, change the language and keyboard layout.
Note: The node's PWR indicator should be red at this stage. If not, restore the node to its default settings (see page 20).
- 4 Click OK to continue.

Alternative shortcut for adding a new transmitter

- 1 Connect your new node fully into the XDIP installation.
- 2 From a receiver, enter the OSD and then enter the Admin menu.
- 3 Choose the *Setup Channels* page and click the **+** icon in the lower right corner.
- 4 Click the new *SoL* entry in the list.
- 5 Configure the necessary transmitter details and click OK.
- 6 Click the *Back* button to return to the Channels List and, if necessary, adjust the position of the new transmitter within the list.
- 7 Click the **✕** icon to exit to the OSD channel list.

You will now be given a choice of turning this *Start of Life* node into either a receiver or a transmitter:

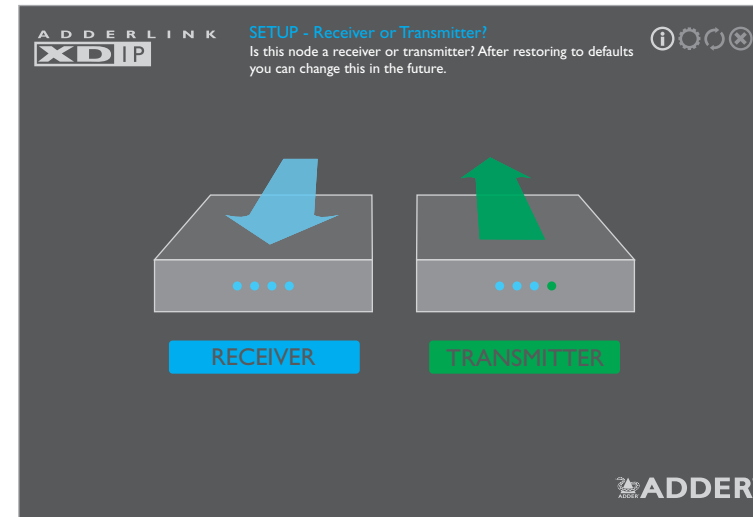

- 5 Click the TRANSMITTER option. You can now enter the details for the node to which your console peripherals are currently connected:

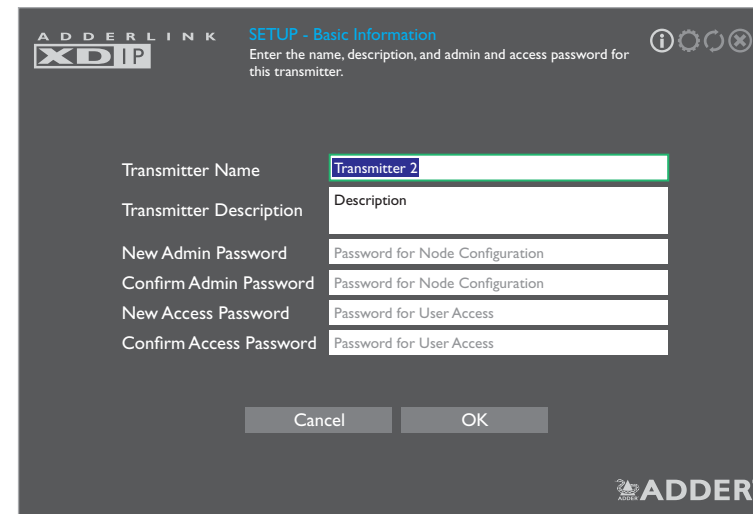

INITIAL CONFIGURATION (continued)

- 6 Enter the details for this transmitter, including two separate passwords:
- The *Admin Password* is required to administer the configuration details only,
 - The *Access Password* allows you to restrict who is allowed to connect to this transmitter. When the Access Password is set, a user will be prompted to enter it when first attempting to add this transmitter node to their receiver node's channels list; if the Access Password is left blank, there will be no access restrictions.
- The Access Password is also used by external systems when creating matrix control installations.
- Note: The Name and Description fields for each entry cannot be left blank.*
- 7 The basic configuration for this node is now complete but it still needs to be registered within the XDIP network. If the new node is not already physically linked into your XDIP installation, connect it now (see page 12).
- 8 Using the console peripherals connected to a receiver node within the installation, enter the receiver's OSD: Press CTRL + ALT + C *
- 9 Click the icon in the top right corner and then choose the *Setup Channels* page:

* *Note: The standard hotkey combinations can be changed. See page 22.*

- 10 Click the icon in the lower right corner to list all available transmitter (and SoL) nodes:

- 11 Move the highlight to your new node and select it so that the TX prefix becomes a channel number (the shade of the highlight will also change). Repeat this step for any other new nodes that need to be included.
- 12 Click the Back button to return to the Channel List:

- Your new node is now integrated and ready to be selected. Click the icon in the top right corner to exit from the Admin menu. See page 31 for details about Operation.

RESTORING A NODE

In order to obtain the full benefit of the configuration wizard when creating a new installation, it may be necessary to restore the default settings to your XDIP nodes.

Note: A restore operation will reset all configuration settings and cannot be undone.

A restore operation can be invoked in various ways:

- [Receivers] Display the channel list and then click the icon in the top right corner. If requested, enter the admin password and then choose the **Software Upgrade** page. Click the **Restore** button:

- [Transmitters] From any connected receiver node, display the channel list and then click the icon in the top right corner. If requested, enter the admin password and then choose the Setup Channels page.
- Click the icon shown next to the name of the transmitter that you wish to restore, then choose the **Software Upgrade** page and click the **Restore** button:

- [Receivers or transmitters] Use a narrow implement (such as a straightened out paper clip) to press and hold the recessed reset button on the front panel (while power is applied) for just over ten seconds until the front panel PWR indicator flashes; then release the button and wait for the node to reboot and display the Recovery page. Click the **Restore** button.

Notes:

- The reset button is within the hole to the left of the USB socket.
- You will need a minimum of a monitor and either keyboard/mouse connected to the node being restored.

ADMIN MENUS

Once an AdderLink XDIP installation has undergone its initial configuration, if necessary you can make further alterations using the Admin menu. An Admin menu is accessible via each receiver; wherein changes can be made to that receiver and/or any of the linked transmitters.

To enter the Admin menu

- 1 From any connected receiver node, enter the receiver's OSD: Press CTRL + ALT + C*
- 2 Click the icon in the top right corner to display the receiver's General Settings page (see below), you will be requested to enter an admin password.

Most pages have an *Apply* button which must be clicked after making changes in order to save them. Alternatively, you can select the *Cancel* button to exit a page without retaining your latest changes.

To exit any Admin page, click the icon in the top right corner.

To view the configuration details for a transmitter node, see page 27.

* *Note: The standard hotkey combinations can be changed, see page 22*

The various parts of the Admin menu are detailed on the following pages:

Receiver node		Transmitter node	
General Settings	<i>this page</i>	General Settings	<i>page 27</i>
OSD Settings	<i>page 22</i>	Manage Ports	<i>page 28</i>
Setup Channels	<i>page 27</i>	Advanced	<i>page 29</i>
Manage Ports	<i>page 23</i>	Software Upgrade	<i>page 30</i>
Advanced	<i>page 24</i>		
Software Upgrade	<i>page 26</i>		

Receiver node settings

General Settings page

When you enter the Admin Menu, the first page to be displayed will be the General Settings page for the receiver to which you are directly connected. This page provides basic information for this node:

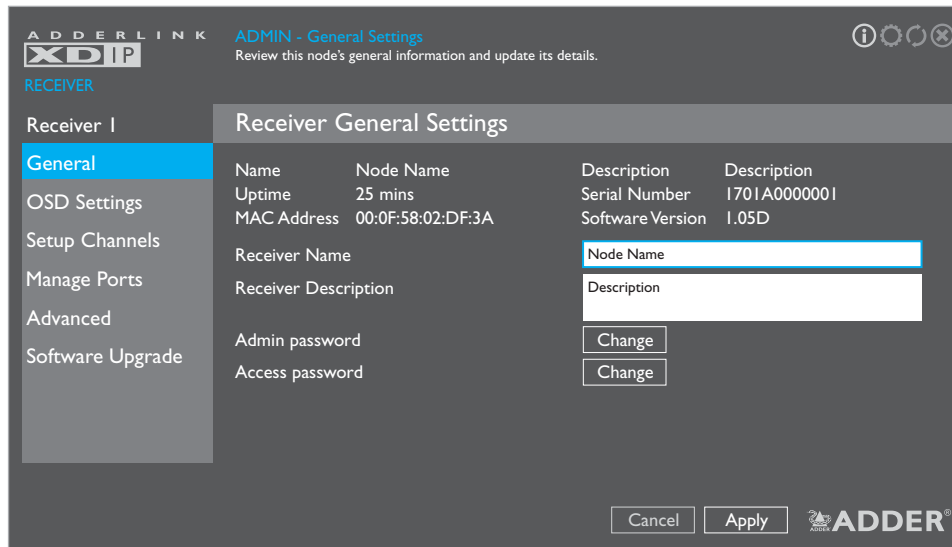

Name and Description

These tags are useful for differentiation purposes when numerous nodes are being used. Use the *Receiver Name* and *Receiver Description* fields to change them.

Time and Date

These are shown only if access to an NTP server is available. The current time and date are frozen within this page and do not automatically update.

Serial Number

Shows the unique hardware identity applied to this node.

MAC Address

Shows the unique network identity applied to this node.

Software Version

Shows the current main version of internal firmware.

Receiver Name and Receiver Description

These fields allow you to change the name and description tags for this node.

Admin Password

Allows you to change the administration password (that protects this menu).

Access Password

Allows you to change the password that restricts access to this node by transmitters and also external control systems.

OSD Settings page

This page contains all settings related directly to the On Screen Display menu:

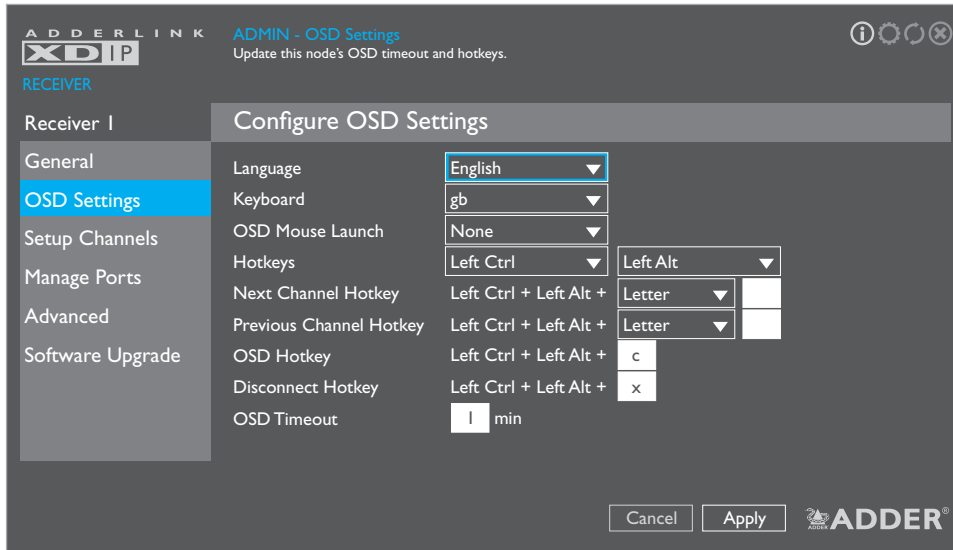

Language

Determines the language used for all OSD menu text. Options are: English, Français, Español and Deutsch.

Keyboard

Determines the layout styles used for the keyboard attached to the receiver. Options include: gb, us, fr, de and es.

OSD Mouse Launch

Allows you to optionally choose mouse button combinations that will launch the OSD menu.

Hotkeys

Allows you to change the two main hotkeys which are used to indicate that you wish to communicate with the receiver itself rather than any of the connected computers.

Next and Previous Channel Hotkey

Allows you to define keyboard buttons which, when used together with the chosen main hotkeys, will move to the next or previous channel (based on the receiver node's channel list). Options include Tab, Backspace, Enter, Space, the arrow keys or any keyboard Letter (which needs to be defined in the white box on the right). *Note: If the Letter option is selected, but no letter is defined within the white box, then the functionality is disabled.*

OSD Hotkey

Defines the key which, when used together with the chosen main hotkeys, will display the OSD menu.

Disconnect Hotkey

Defines the key which, when used together with the chosen main hotkeys, will disconnect the receiver from the currently chosen channel.

OSD Timeout

Defines the period of inactivity (in whole minutes) that should pass before the OSD menu is automatically exited (0 disables the OSD timeout). *Note: The automatic timeout from the Admin menu is fixed at 15 minutes.*

Manage Ports page

All settings within these pages relate to the video monitor, USB devices and/or local computer that are connected to this receiver node.

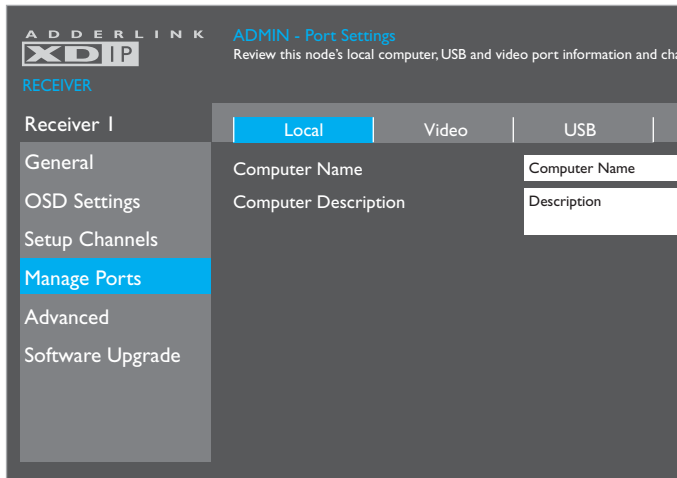

Computer Name and Computer Description

These tags are useful for differentiation purposes when numerous nodes are being used. These fields allow you to change the name and description tags for the computer that is directly attached to this receiver node (shown on the OSD as channel 0).

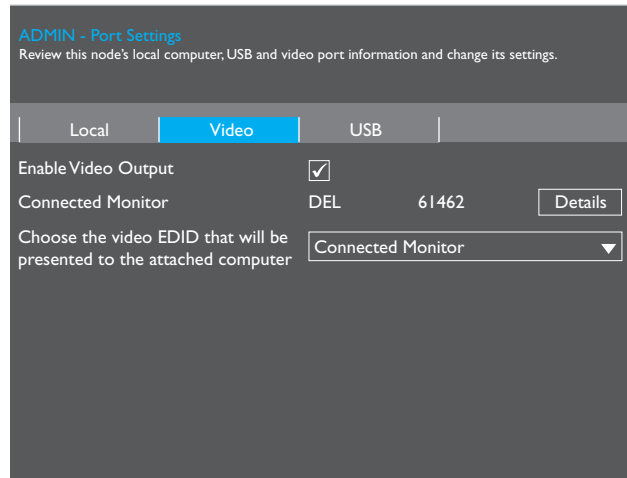

Connected Monitor

Lists the basic details for the monitor connected to the console video output of this receiver node. Click on the *Details* button to view more information about the connected video monitor:

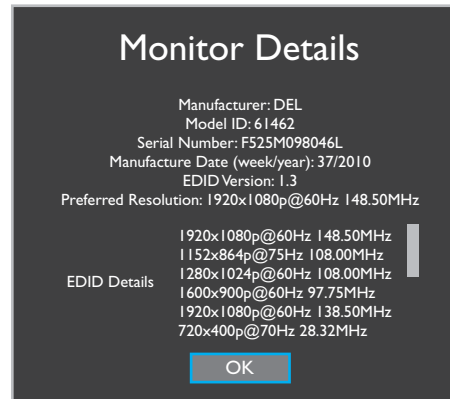

Choose the video EDID....

Allows you to choose to rely upon the *Automatic* EDID configuration for the connected monitor or to manually select one of the listed modes.

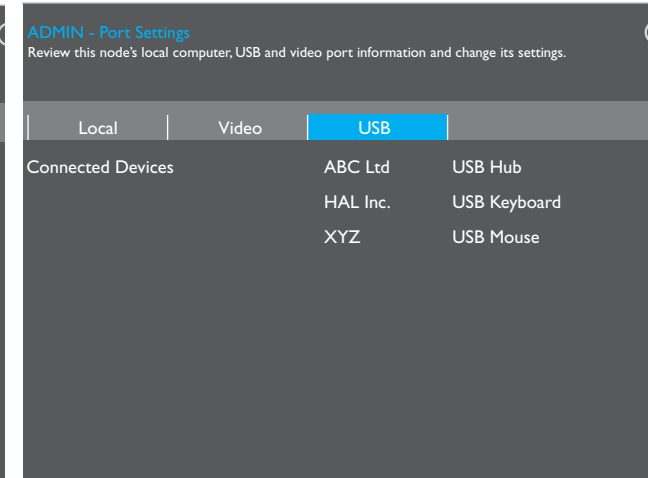

Connected Devices

Lists the USB devices which are currently connected to this receiver node. Click the *Details* button to view more information about the device.

Advanced page

The items within these pages relate to the network settings, network test, diagnostic tools and statistics for the chosen receiver node.

Receiver I	Network Info	Network Test	Diagnostics	Statistics
General	Dynamic IP Address	192.168.1.34	Static IP Address	0.0.0.0
OSD Settings	Dynamic Netmask	255.255.255.0	Static Netmask	255.255.255.0
Setup Channels	Dynamic Gateway	192.168.1.1	Static Gateway	192.168.20.1
Manage Ports	MAC Address	00:0F:58:02:DF:3A		
Advanced	DHCP Server	91.134.24.29		
Software Upgrade	NTP Server	93.0.123.145		
	DNS Address	128.0.124.53		
	Enable Remote Control	<input checked="" type="checkbox"/>		

Dynamic IP details

Dynamic IP address details are configured automatically in either of two ways:

- With the use of a DHCP server, if one is available during configuration, or
- Using Link-Local addresses (169.254.x.x).

Static IP details

In addition to the main Dynamic IP address used by each receiver, a separate set of static IP address details are available for use when an XDIP installation will be externally controlled. The static IP address provide a consistent control channel into the receiver, protected by the Access Password.

Enable Remote Control

When ticked, this function allows the receiver to be controlled by external systems in order to coordinate the actions of multiple XDIP units; either using the Adder XDIP Public REST API or by web browser access to the OSD on the chosen receiver. See pages 3, 32 and 38 for details.

Receiver I

- General
- OSD Settings
- Setup Channels
- Manage Ports
- Advanced
- Software Upgrade

Network Test

Select a Node [v] [Ping]

Select a Node [v] [IGMP]

This page provides basic network testing tools to allow you to test and confirm the link between this receiver node and any chosen transmitter node.

Choose a node and click the Ping button to obtain packet loss and speed details.

Choose a transmitter node and click the **IGMP** button to view test results.

Note: IGMP Fast Leave and Snooping must be supported and enabled on your network switch, otherwise these tests will produce a 'Failed' result. A 'Marginal' result indicates that packets are still arriving after an allotted cut off period.

Results are provided in the manner shown below:

Receiver I

- General
- OSD Settings
- Setup Channels
- Manage Ports
- Advanced
- Software Upgrade

Network Test

Transmitter I [v] [Ping]

Packet Loss 0% Minimum Response Time 0.178 ms

Average Response Time 1.441 ms Maximum Response Time 6.478 ms

Transmitter I [v] [IGMP]

IGMP Version 3

IGMP Fast Leave Status Marginal IGMP Snooping Status Passed

Multicast Leave Duration 3410.059 ms

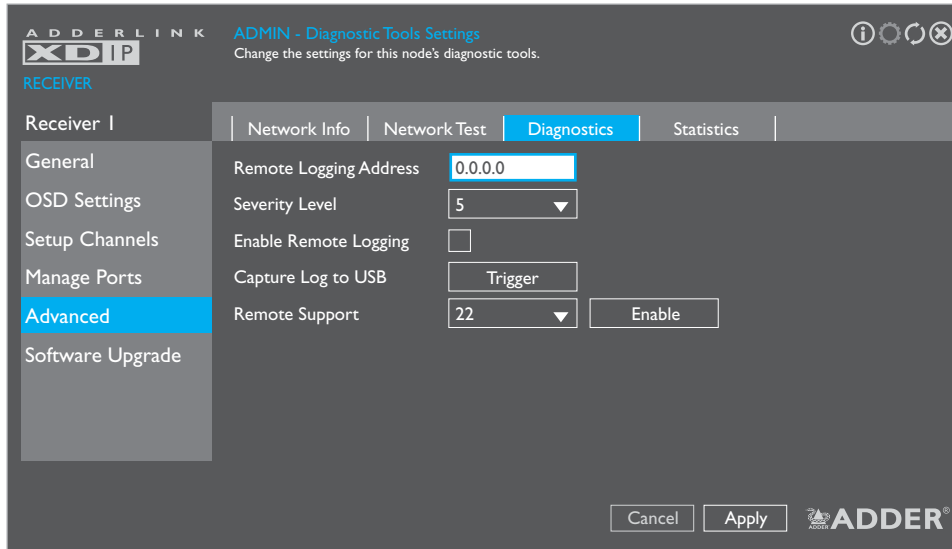

Remote Logging Address

Enter a valid IP address for a syslog server on the local network where status logs can be sent.

Severity Level

Defines the level of messages that will be logged (according to RFC5424). Level 5 (*Notice: normal but significant condition*) is the default setting; XDIP currently supports levels 1 to 7. Choosing levels 6 (*Informational*) or 7 (*Debug*) will cause larger numbers of lesser events to also be logged, with a potential impact to overall performance. These levels should only be used if working with the support team to diagnose a specific issue.

Enable Remote Logging

Tick to send log files to the chosen *Remote Logging Address*.

Capture Log to USB

Click the Trigger button to save the activity log to a local USB memory stick. The resulting compressed file can then be sent to Adder support when diagnosing an issue.

Remote Support

When using the Adder remote server, this option determines which port will be used. Multiple options are offered in case one or more ports are blocked by your firewall.

Note: This option should only be enabled when requested by Adder, for support purposes.

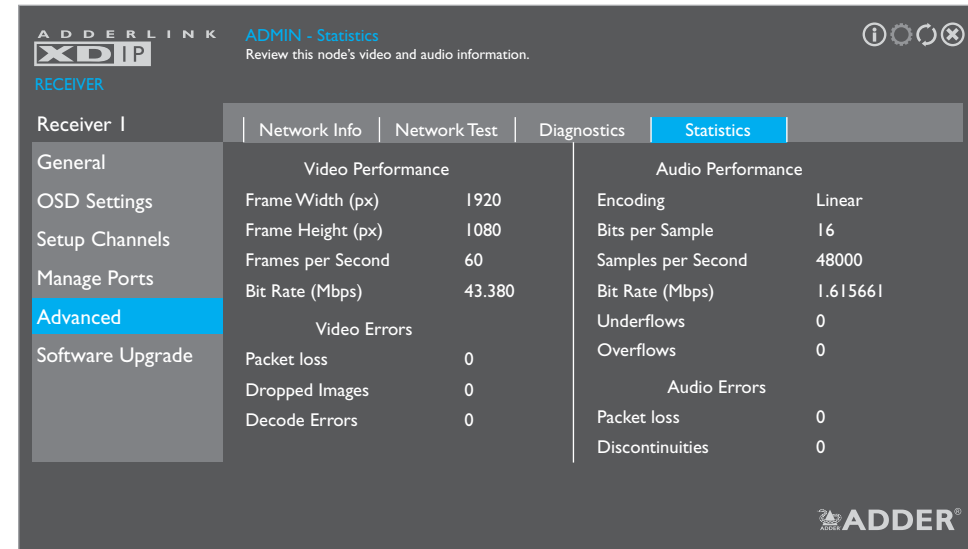

This page provides statistical details regarding the video and audio performance.

Software Upgrade page

The items within this page relate to the software settings, restore/reboot and firmware upgrade option for the chosen receiver node.

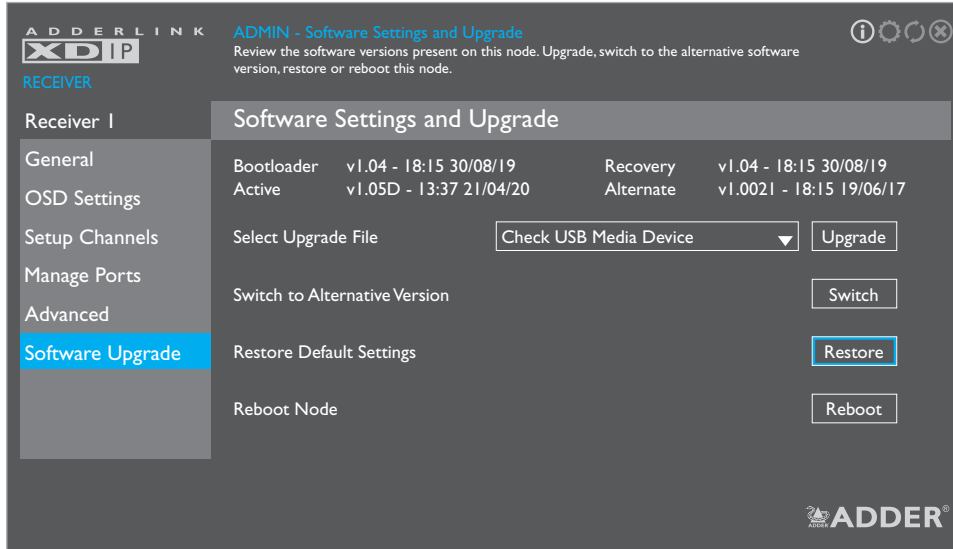

ADDER LINK ADMIN - Software Settings and Upgrade
 Review the software versions present on this node. Upgrade, switch to the alternative software version, restore or reboot this node.

Receiver 1

Software Settings and Upgrade	
General	Bootloader v1.04 - 18:15 30/08/19 Recovery v1.04 - 18:15 30/08/19
OSD Settings	Active v1.05D - 13:37 21/04/20 Alternate v1.0021 - 18:15 19/06/17
Setup Channels	Select Upgrade File <input type="text"/> Check USB Media Device <input type="button" value="Upgrade"/>
Manage Ports	Switch to Alternative Version <input type="button" value="Switch"/>
Advanced	Restore Default Settings <input type="button" value="Restore"/>
Software Upgrade	Reboot Node <input type="button" value="Reboot"/>

Supported file systems

When using USB memory sticks, the following file systems are supported:

- FAT
- NTFS
- Non-journaled HFS+

Firmware details

Lists the current and recovery *Bootloader* versions plus the *Active* image that is currently running as well as the *Alternate* (the previously active) image version details.

Select Upgrade File

Any valid firmware upgrade files held (only in the root menu) on a memory stick in one of the USB sockets will be listed here (if necessary click the  icon to update after insertion). Select the required file name and click the *Upgrade* button. The new firmware will be made current and the pre-existing code moved to the recovery/alternate location.

Switch to Alternative Version

Allows you to change back to the previous firmware version that was running before the last upgrade.

Restore Default Settings

Click to restore this receiver to its default *Start of Life (SoL)* condition.

Note: A restore operation will reset all configuration settings and cannot be undone.

Reboot Node

Click to reboot this receiver.

Setup Channels page

Transmitter nodes can be configured via the Setup Channels page, accessible via any receiver. (Enter the receiver's OSD: Press CTRL + ALT + C*, click the icon in the top right corner and then choose the Setup Channels page). Here you can:

- Change the channel order - drag and drop a node entry into the required slot (or use the arrow keys).
- Add a transmitter node to the list - click the icon in the lower right corner.
- Flash the front panel indicators of any transmitter node - click the node's icon.
- Remove a transmitter node from the list - click the node's icon.
- Configure a transmitter node - click the node's icon:

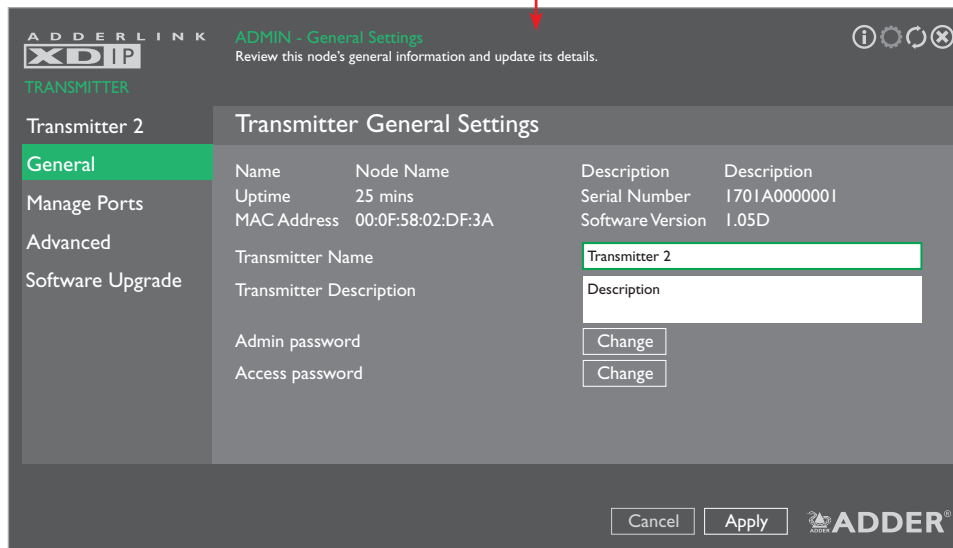
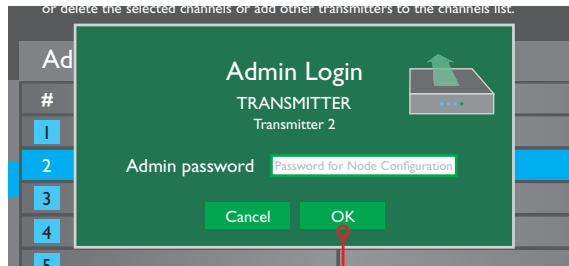
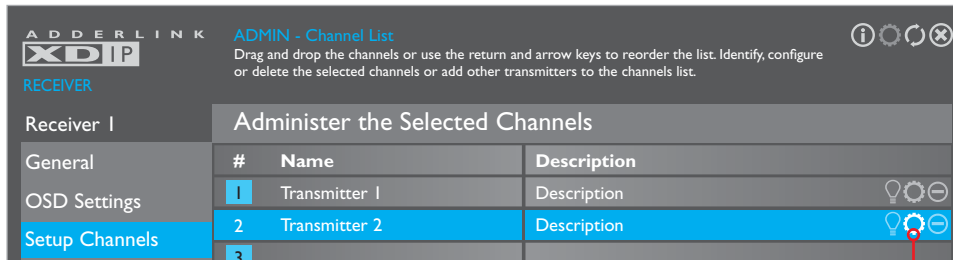

Transmitter node settings

- 1 From any connected receiver node, enter the receiver's OSD: Press CTRL + ALT + C*, then click the icon in the top right corner.
- 2 Choose the Setup Channels page and click the icon shown next to the name of the transmitter that you wish to configure.
- 3 You will be requested to enter the admin password. The transmitter's General Settings page will be shown.

Note: All Admin menu pages related directly to transmitter configuration use a green highlight to match the color of the PWR indicator of nodes when they are in transmitter mode.

General Settings page

This page provides basic information for this node:

Name and Description

These tags are useful for differentiation purposes when numerous nodes are being used. Use the *Transmitter Name* and *Transmitter Description* fields to change them.

Time and Date

These are shown only if access to an NTP server is available. The current time and date are frozen within this page and do not automatically update.

Serial Number

Shows the unique hardware identity applied to this node.

MAC Address

Shows the unique network identity applied to this node.

Software Version

Shows the current main version of internal firmware.

Transmitter Name and Transmitter Description

These fields allow you to change the name and description tags for this node.

Admin Password

Allows you to change the administration password (that protects this menu).

Access Password

Allows you to change the password that restricts access to this node by receivers and also external control systems.

* *Note: The standard hotkey combinations can be changed. See page 22.*

Manage Ports pages

To access these pages: From a receiver, enter the OSD menu: Press CTRL + ALT + C hotkeys, then click the icon to show the Admin menu. Choose the Setup Channels page, click the icon for the required transmitter node and then click the Manage Ports option. See page 27.

All settings within these pages relate to the optional video monitor, USB devices and/or audio devices that are connected to the chosen transmitter node.

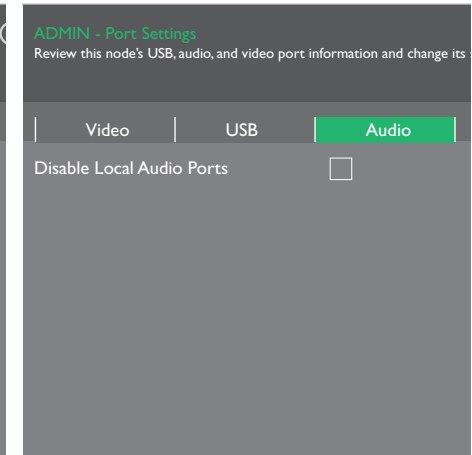
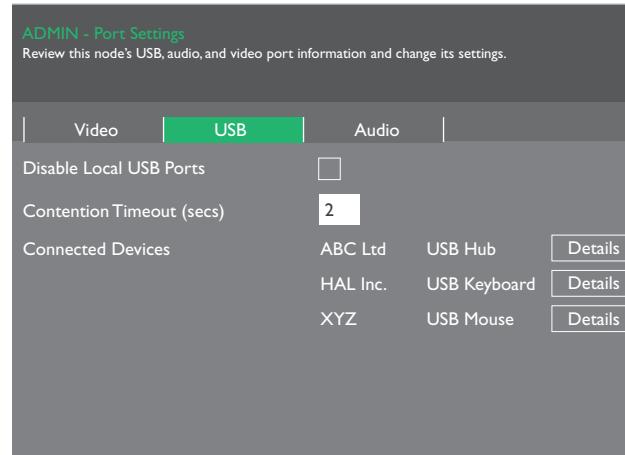
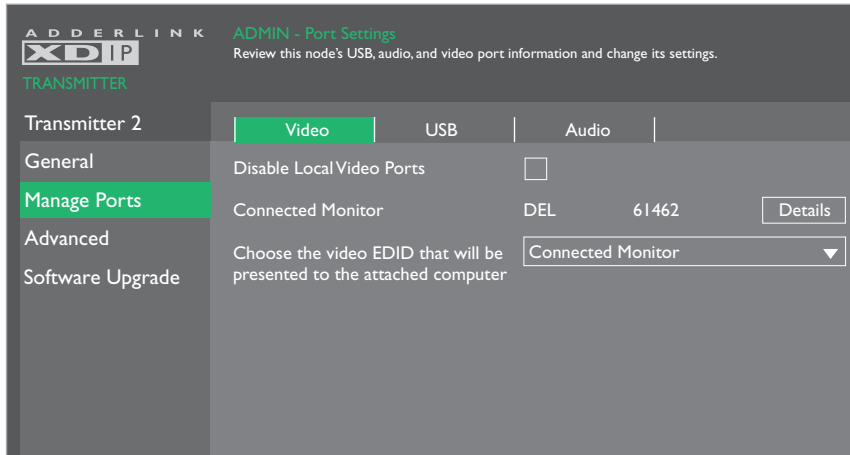

Disable Local Video Ports

Allows you to temporarily disable the video output to the optional console connection on the transmitter node.

Connected Monitor

Lists the basic details for the monitor connected to the console video output of the transmitter node. Click on the Details button to view more information about the connected video monitor:

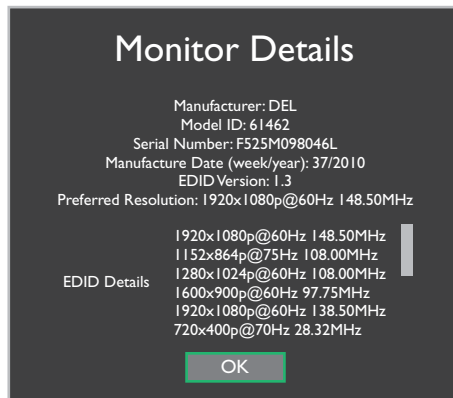

Choose the video EDID....

Allows you to choose between the Automatic EDID configuration for the connected monitor or to choose one of the listed modes.

Disable Local USB Ports

Allows you to temporarily disable the USB signals to any devices optionally connected to the transmitter node.

Contention Timeout (secs)

USB links to the host computer are shared between multiple receivers in a first come first served manner. The first receiver to access a USB peripheral will be given control access, while all others are temporarily prevented, until the first receiver has completed its actions. The contention timeout is the time delay, after the last USB activity of the first receiver, before USB access becomes available again to all.

Connected Devices

Lists the USB devices which are currently connected to the transmitter node. Click the Details button to view more information about the device.

Disable Local Audio Ports

Allows you to disable the audio signals to devices optionally connected to the transmitter node.

Advanced pages

To access these pages: From a receiver, enter the OSD menu: Press CTRL + ALT + C hotkeys, then click the icon to show the Admin menu. Choose the Setup Channels page, click the icon for the required transmitter node and then click the Advanced option. See page 27.

The items within these pages relate to the network settings, diagnostic tools and statistics for the chosen transmitter node.

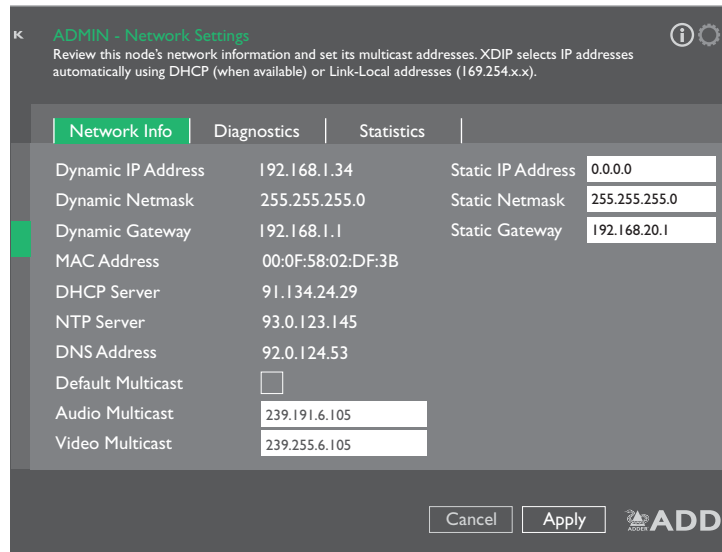

Dynamic IP details

Dynamic IP address details are configured automatically in either of two ways:

- With the use of a DHCP server, if one is available during configuration, or
- Using Link-Local addresses (169.254.x.x).

Static IP details

In addition to the main Dynamic IP address used by each receiver, a separate set of static IP address details are available for use when an XDIP installation will be externally controlled. The static IP address provide a consistent control channel into the transmitter, protected by the Access Password.

Default Multicast

Tick this option and click the Apply button to re-apply the default Audio and Video Multicast addresses (as shown in the two fields below).

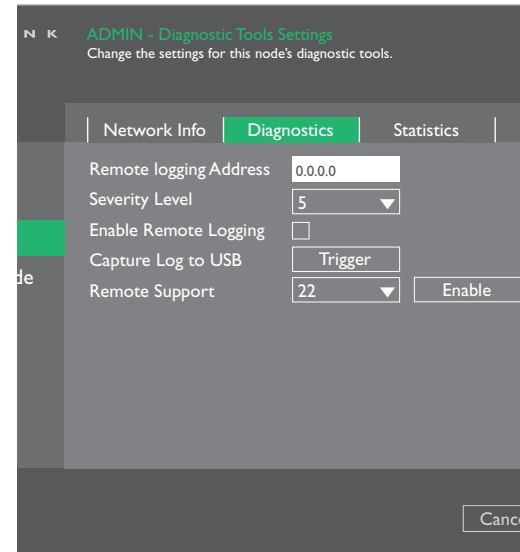

Remote Logging Address

Enter a valid IP address for a syslog server on the local network where status logs can be sent.

Severity Level

Defines the level of messages that will be logged (according to RFC5424). Level 5 (Notice: normal but significant condition) is the default setting; XDIP currently supports levels 1 to 7. Choosing levels 6 (Informational) or 7 (Debug) will cause larger numbers of lesser events to also be logged, with a potential impact to overall performance. These levels should only be used if working with the support team to diagnose a specific issue.

Enable Remote Logging

Tick to send log files to the chosen Remote Logging Address.

Capture Log to USB

Click the Trigger button to save the activity log to a local USB memory stick (must be plugged directly into a port on the transmitter node in question - not the receiver you are using for access). The resulting compressed file can then be sent to Adder support when diagnosing an issue.

Remote Support

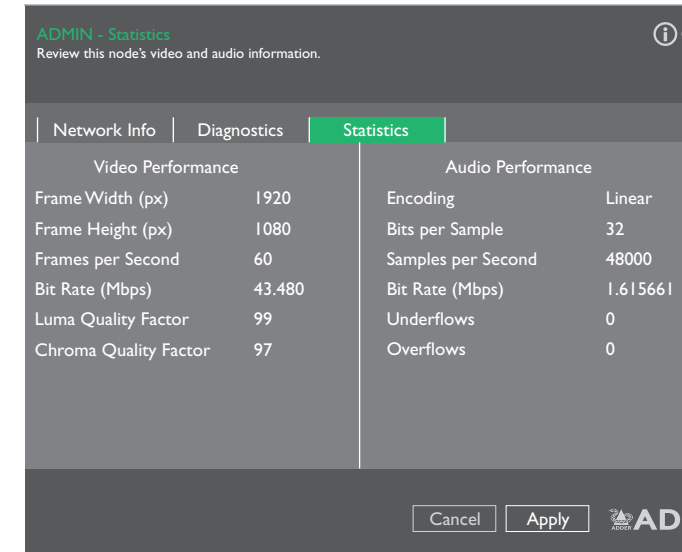

When using the Adder remote server, this option determines which port will be used. Multiple options are offered in case one or more ports are blocked by your firewall.



This page provides statistical details regarding the video and audio performance.

Note: Video statistics will only be available if no other receiver node is viewing the same video source.

Software Upgrade page

To access this page: From a receiver, enter the OSD menu: Press CTRL + ALT + C hotkeys, then click the  icon to show the Admin menu. Choose the Setup Channels page, click the  icon for the required transmitter node and then click the Software Upgrade option. See page 27.

The items within this page relate to the software settings, restore/reboot and firmware upgrade option for the chosen transmitter node.

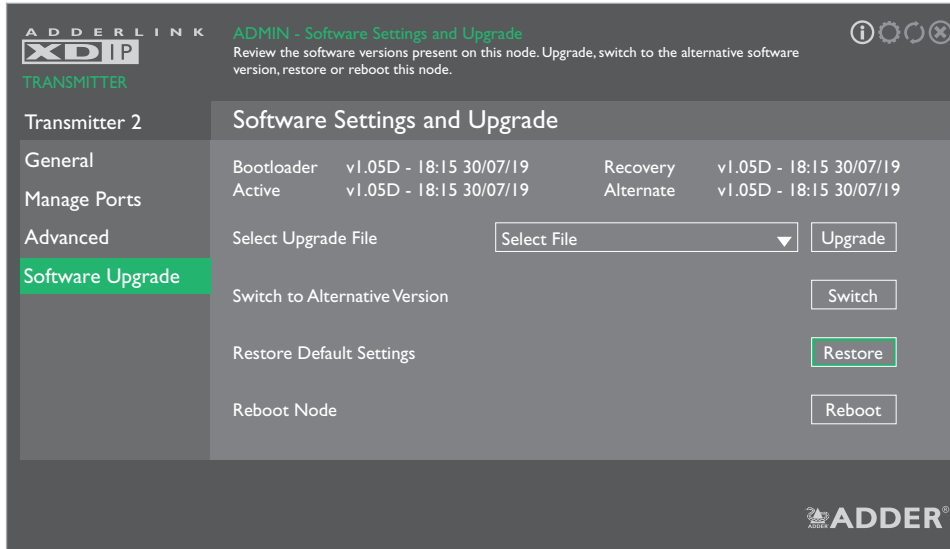

Supported file systems

When using USB memory sticks, the following file systems are supported:

- FAT
- NTFS
- Non-journalled HFS+

Firmware details

Lists the current and recovery *Bootloader* versions plus the *Active* image that is currently running as well as the *Alternate* (the previously active) image version details.

Select Upgrade File

Any valid firmware upgrade files held (only in the root menu) on a memory stick in one of the USB sockets, of the receiver node being used for access, will be listed here (if necessary click the  icon to update after insertion). Select the required file name and click the Upgrade button. The new firmware will be made current and the pre-existing code moved to the recovery/alternate location.

Switch to Alternative Version

Allows you to change back to the previous firmware version that was running before the last upgrade.

Restore Default Settings

Click to restore this receiver to its default *Start of Life (SoL)* condition.

Note: A restore operation will reset all configuration settings and cannot be undone.

Reboot Node

Click to reboot this transmitter node.

AdderLink XDIP nodes provide great flexibility in operation, supporting a variety of connection topologies as discussed in the Introduction chapter (see page 2). Where switching between channels is required, user control is always centered upon the receiver node(s).

SWITCHING CHANNELS

Switching channels from a receiver

To select a channel (using the channel list)

1 Using the console keyboard and/or mouse on your receiver node, either:

- Use the OSD hotkey: Press and hold CTRL and ALT, then press C *
- Use the mouse OSD launch (this needs to be pre-configured - see page 22).

The channel list page should be displayed:

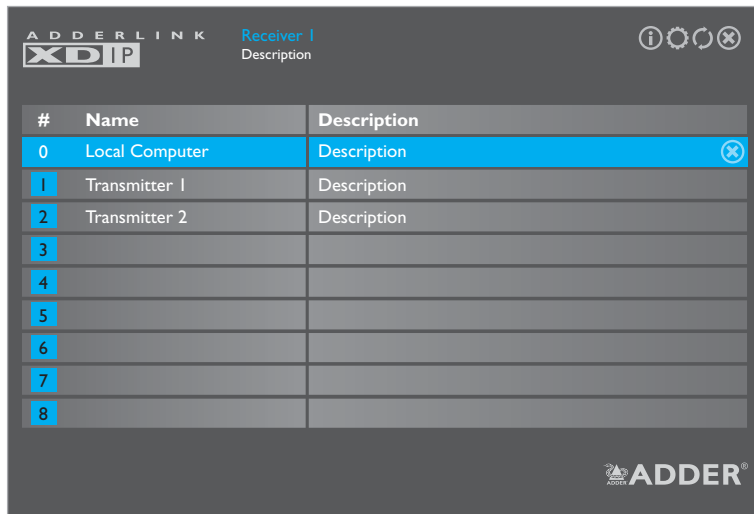

#	Name	Description
0	Local Computer	Description
1	Transmitter 1	Description
2	Transmitter 2	Description
3		
4		
5		
6		
7		
8		

2 Using the mouse, click the required entry (or use cursor up/down keys and Enter).

The channel list will disappear and the output of the chosen channel will be shown on your console monitor.

3 To change to another channel, repeat steps 1 and 2.

To disconnect from a channel (using the channel list)

To disconnect your console from the current channel, without switching to another:

1 Display the channel list (as above).

2 Click the  icon shown next to the currently selected channel.

To select a channel (using hotkeys)

The quickest way to switch between channels is to use hotkeys. This is where the order of transmitter nodes within the channel list really comes into play.

1 Press and hold the CTRL + ALT * keys,

2 Press the number of the required channel (1 to 8 for the transmitters, 0 for the local computer).

The output of the chosen channel will be shown on your console monitor.

To switch between channels (using hotkeys)

Before you can use this method, you will need to define which keys to use, see page 32. For the purposes of this example, we will assume that the letters L and K have been set for next and previous, respectively.

1 Press and hold the CTRL + ALT * keys,

2 Press L to change to the next available channel in the list or K to select the previous one.

To disconnect from a channel (using hotkeys)

To disconnect your console from the current channel, without switching to another:

1 Press and hold the CTRL + ALT, then press X *,

2 Press the number of the required channel (1 to 8 for the transmitters, 0 for the local computer).

* Note: The standard hotkey combinations can be changed, see next page

To set channel switching hotkeys

Hotkey combinations are possible that allow you to change channels without invoking the channel list. The necessary hotkey combinations are not set as standard, but can easily be done so from the OSD Settings page of the receiver's Admin menu.

- 1 Using the console keyboard and/or mouse on your receiver node, press CTRL + ALT + C *
- 2 Click the icon in the top right corner to display the opening page of the receiver's Admin menu, you will be requested to enter a valid admin password.
- 3 Choose the OSD Settings option:

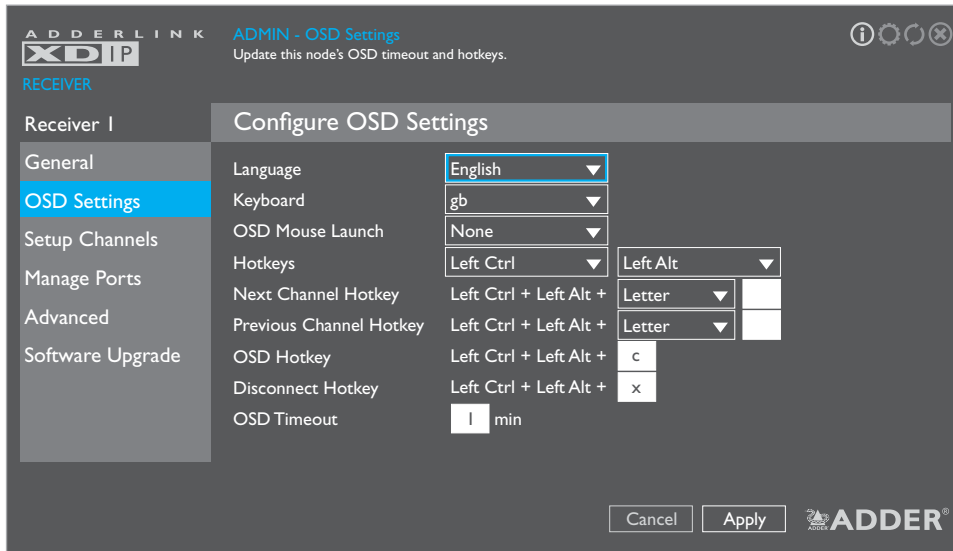

- 4 Configure the Next Channel Hotkey and Previous Channel Hotkey combinations.

Note: When using the Letter option, choose only standard alpha characters and avoid using the characters used for OSD and Disconnect hotkeys. If required, you can change the Letter option to Tab, Backspace, Enter, Space or any of the arrow keys.

Within this page you can also optionally change the main two hotkeys (Ctrl and Alt).

- 5 Click the Apply button and then the icon in the top right corner (or press the Esc key on your keyboard) to exit.

Switching channels from an external system

XDIP installations can be externally controlled either by a control system or a PC connected to the XDIP network. This method is most often used when the XDIP modules form an audio-visual matrix, where multiple receivers access content from a choice of transmitters - see page 3.

When using an external system to control the actions of receivers, you will need to know the following for the receivers being accessed:

- The static IP addresses,
- The access passwords that have been assigned.

To switch channel using an external PC

- 1 From a PC connected to the XDIP network, use a web browser and enter the static IP address of the required receiver and the port 8443: **https://<ip-address>:8443**
- 2 When requested, enter the access password for the receiver and click OK:

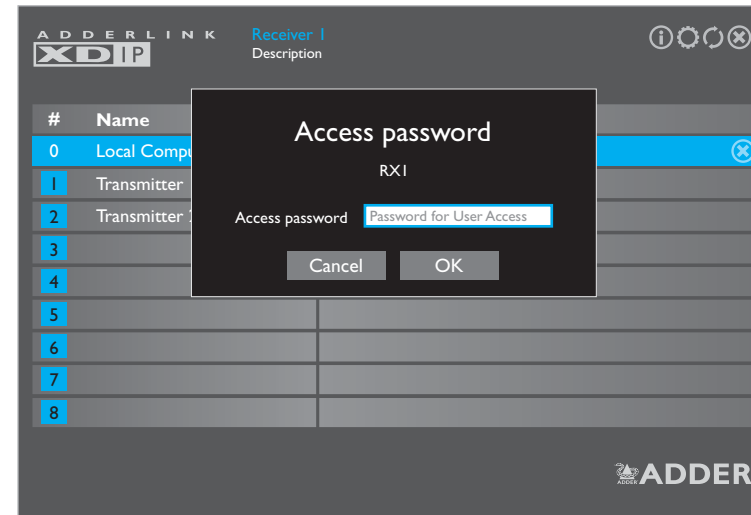

- 3 Select the required transmitter from the list.

INDICATORS

The transmitter and receiver nodes contain various indicators to provide you with status information. Both nodes have four red indicators on their front panels.

Front panel status indicators

The status indicators on the front panel of every node provide important feedback on current operation:

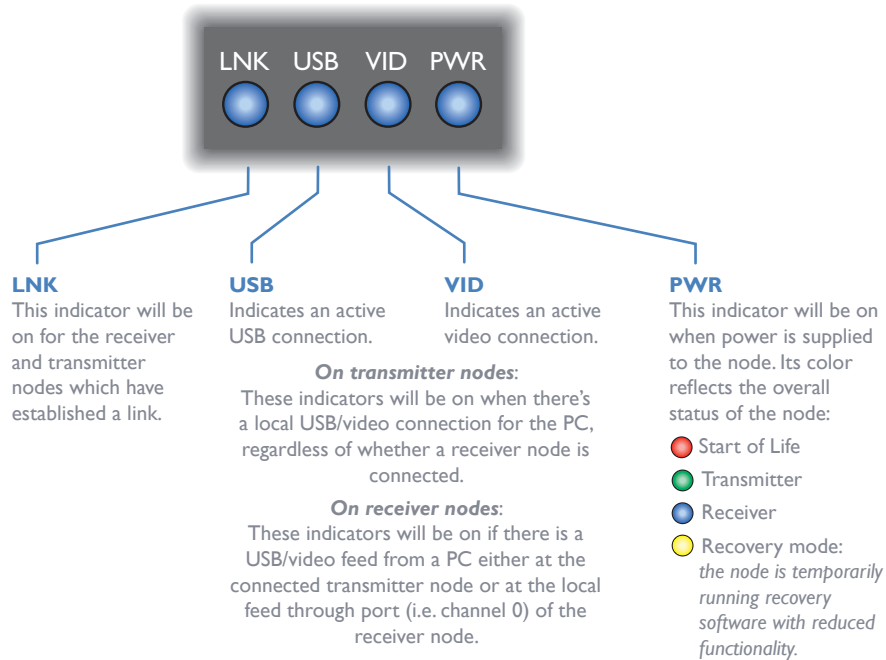

Green and amber status indicators

The indicators on the link port of the node's rear panel provide link status information:

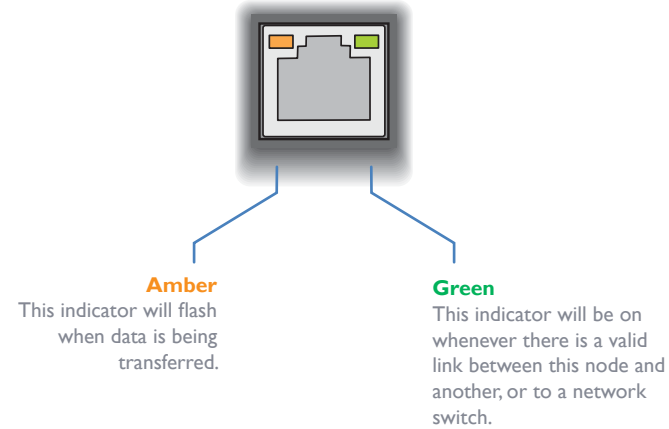

Further information



This chapter contains a variety of information, including the following:

- Getting assistance - see right
- [Appendix 1](#) - IGMP
- [Appendix 2](#) - Layers
- [Appendix 3](#) - Link cable interference protection
- [Appendix 4](#) - XDIP API
- [Appendix 5](#) - Open source licenses

GETTING ASSISTANCE

If you are still experiencing problems after checking the information contained within this guide, then please refer to the Support section of our website:

www.adder.com

INSTALLATION

CONFIGURATION

OPERATION

FURTHER
INFORMATION

INDEX

APPENDIX I - IGMP

Internet Group Management Protocol

Where an AdderLink XDIP transmitter node is required to stream video to two or more receiver nodes, multicasting is used.

Multicasting involves the delivery of identical data to multiple receivers simultaneously without the need to maintain individual links. When multicast data packets enter a subnet, the natural reaction of the switches that bind all the hosts together within the subnet, is to spread the multicast data to all of their ports. This is referred to as Multicast flooding and means that the hosts (or at least their network interfaces) are required to process plenty of data that they didn't request. IGMP offers a partial solution.

The Internet Group Management Protocol (IGMP) is designed to prevent multicast flooding by allowing [Layer 3](#) switches to check whether host computers within their care are interested in receiving particular multicast transmissions. They can then direct multicast data only to those points that require it and can shut off a multicast stream if the subnet has no recipients.

There are currently three IGMP versions: 1, 2 and 3, with each version building upon the capabilities of the previous one:

- IGMPv1 allows host computers to opt into a multicast transmission using a Join Group message, it is then incumbent on the router to discover when they no longer wish to receive; this is achieved by polling them (see IGMP Querier below) until they no longer respond.
- IGMPv2 includes the means for hosts to opt out as well as in, using a Leave Group message.
- IGMPv3 encompasses the abilities of versions 1 and 2 but also adds the ability for hosts to specify particular sources of multicast data.

AdderLink XDIP nodes make use of IGMP v2 and v3 (v3 is used by default unless the XDIP nodes see v2 used by the network, in which case they will automatically drop down to IGMP v2) when performing multicasts to ensure that no unnecessary congestion is caused.

IGMP Snooping

The IGMP messages are effective but only operate at [layer 2](#) - intended for routers to determine whether multicast data should enter a subnet. A relatively recent development has taken place within the switches that glue together all of the hosts within each subnet: IGMP Snooping. IGMP snooping means these layer 2 devices now have the ability to take a peek at the IGMP messages. As a result, the switches can then determine exactly which of their own hosts have requested to receive a multicast – and only pass on multicast data to those hosts.

IGMP Querier

When IGMP is used, each subnet requires one [Layer 3](#) switch to act as a Querier. In this lead role, the switch periodically sends out IGMP Query messages and in response all hosts report which multicast streams they wish to receive. The Querier device and all snooping Layer 2 switches, then update their lists accordingly (the lists are also updated when Join Group and Leave Group (IGMP v2 or v3) messages are received).

IGMP Fast-Leave (aka Immediate Leave)

When a device/host no longer wishes to receive a multicast transmission, it can issue an IGMP Leave Group message as mentioned above. This causes the switch to issue an IGMP Group-Specific Query message on the port (that the Leave Group was received on) to check no other receivers exist on that connection that wish to remain a part of the multicast. This process has a cost in terms of switch processor activity and time.

Where AdderLink XDIP nodes are connected directly to the switch (with no other devices on the same port) then enabling IGMP Fast-Leave mode means that switches can immediately remove receivers without going through a full checking procedure. Where multiple nodes are regularly joining and leaving multicasts, this can speed up performance considerably.

APPENDIX 2 - LAYERS

Layer 2 and Layer 3: The OSI model

When discussing network switches, the terms Layer 2 and Layer 3 are very often used. These refer to parts of the Open System Interconnection (OSI) model, a standardised way to categorize the necessary functions of any standard network.

There are seven layers in the OSI model and these define the steps needed to get the data created by you (imagine that you are Layer 8) reliably down onto the transmission medium (the cable, optical fibre, radio wave, etc.) that carries the data to another user; to complete the picture, consider the transmission medium is Layer 0. In general, think of the functions carried out by the layers at the top as being complex, becoming less complex as you go lower down.

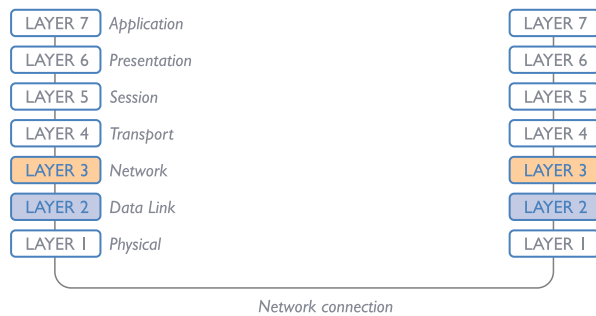

As your data travel down from you towards the transmission medium (the cable), they are successively encapsulated at each layer within a new wrapper (along with a few instructions), ready for transport. Once transmission has been made to the intended destination, the reverse occurs: Each wrapper is stripped away and the instructions examined until finally only the original data are left.

So why are Layer 2 and Layer 3 of particular importance when discussing AdderLink XDIP? Because the successful transmission of data relies upon fast and reliable passage through network switches – and most of these operate at either Layer 2 or Layer 3.

The job of any network switch is to receive each incoming network packet, strip away only the first few wrappers to discover the intended destination then rewrap the packet and send it in the correct direction.

In simplified terms, the wrapper that is added at Layer 2 (by the sending system) includes the physical address of the intended recipient system, i.e. the unique MAC address (for example, 09:f8:33:d7:66:12) that is assigned to every networking device at manufacture. Deciphering recipients at this level is more straightforward than at Layer 3, where the address of the recipient is represented by a logical IP address (e.g. 192.168.0.10) and requires greater knowledge of the surrounding network structure. Due to their more complex circuitry, Layer 3 switches are more expensive than Layer 2 switches of a similar build quality and are used more sparingly within installations.

APPENDIX 3 - LINK CABLE INTERFERENCE PROTECTION

While the Category rating (e.g. CAT 5e, CAT 6a, CAT 7, etc.) determines the electrical performance of a cable, another vital part of the overall cable specification is its protection from interference. As cabling distances and data rates increase, so too does the susceptibility to interference, from both external and internal sources.

Proximity to other electromagnetic sources are the main external threat and these can be subdued using overall screening that surrounds all four of the cable pairs. However, interference is also possible from neighbouring twisted pairs within the same cable and this can be just as hazardous to data integrity. Such *crosstalk* is countered by shielding each cable pair separately.

Within each Category rating, you can specify different combinations of external screening and internal shielding to suit the environment into which the link is being placed.

Interference protection codes

Interference protection is classified in the following manner:

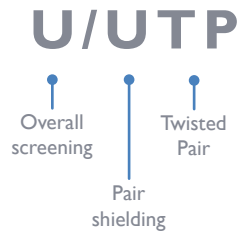

where

U = unshielded

F = foil shielding

S = braided shielding

PiMF = Pairs in Metal Foil

Name	Overall Screening	Pair Shielding
U/UTP	✗	✗
F/UTP	✓	✗
U/FTP	✗	✓
S/FTP or S/STP or PiMF	✓	✓

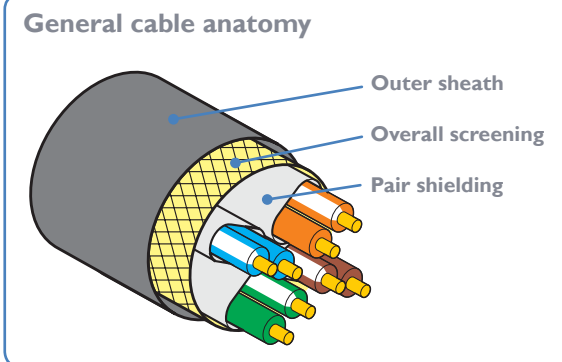
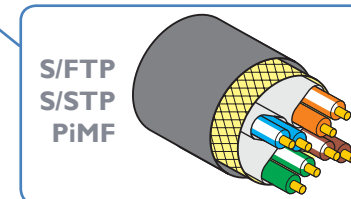
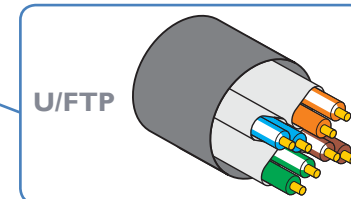
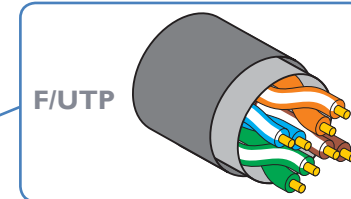
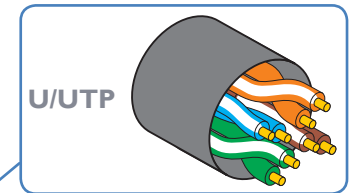

APPENDIX 4 - XDIP API

Adder Technology XDIP Public REST API

The API gives the user the ability to control the channel a receiver is connected to, obtain all the necessary information relating to the connected channel and gain an authorization access token required to switch channels, given knowledge of the node's 'Access' password. It does not give the user the ability to change the channel configuration or any other part of the node's configuration, in order to do this a user must log in to the OSD directly and access the admin screen - which will require knowledge of the 'Admin' password.

Note: Before receivers can be controlled by external systems, the 'Enable Remote Control' option must be checked within the Advanced page of each receiver's configuration. See page 24.

YAML download

The YAML file for the API can be found at:

- <https://support.adder.com/tiki/tiki-index.php?page=XDIP%3A+Using+the+API>

API version 1.05

Schemes: HTTPS

- The API uses SSL/TLS version 1.2
- Commands are sent over port 8443, for example:
`https://<ip-address>:8443/api/<parameters>`

Channels

/channels

Returns a list of channels configured in the system. For future use, each channel will have a list of nodes. Currently only one node is returned in this list.

Type: Get

Responses

- 200 OK
- 304 Not Modified
- 500 Operation Failed

/channels/{id}

Get details of a single channel.

Type: Get

Responses

- 200 OK
- 304 Not Modified
- 404 Channel Id Not In Supported Range
- 500 Operation Failed

/channels/connected

Get the channel this node is currently connected to.

Type: Get

Responses

- 200 OK
- 304 Not Modified
- 404 Channel Id Not In Supported Range
- 500 Operation Failed

/channels/{id}/switch

Switch node to the specified channel.

Type: Post

Parameters

id Channel Id. An id of 0x7ffffff will cause the receiver to disconnect from the current channel.

Authorization Access / Admin JSON Web Token (JWT). Format 'Bearer JWT'.

Responses

- 204 Successful Operation (No Content)
- 401 Unauthorized. Invalid Access Credentials Provided.
- 404 Channel Id Not In Supported Range
- 500 Operation Failed

/channels/maximumAllowed

Get the maximum number of channels supported by this node.

Type: Get

Responses

- 200 OK
- 304 Not Modified
- 500 Operation Failed

/channels/status

Get the status for the currently selected channel.

Type: Get

Responses

- 200 OK
- 304 Not Modified
- 500 Operation Failed

Nodes

/nodes/{uuid}

Get details of a single node.

Type: Get

Parameters

uuid The node's unique identifier (or 'self' for the local node).

Responses

200 OK
304 Not Modified
404 UUID Not Found
500 Operation Failed

/nodes/selected

Returns a list and details of the configured Channel nodes.

Type: Get

Responses

200 OK
304 Not Modified
500 Operation Failed

Access

/nodes/self/access

Obtain an Access / Admin JSON Web Token (JWT).

Type: Post

Parameters

authData Password attributes.

Responses

200 OK
400 Invalid Content (Schema)
401 Unauthorized
404 UUID Not Found
500 Operation Failed

LocalComputer

/localComputer

Get information relating to the computer that is connected to this node.

Responses

200 OK
304 Not Modified
500 Operation Failed

APPENDIX 5 - OPEN SOURCE LICENSES

This product includes binaries that are derived from the open source community.

The modules listed below are licenced under the GNU General Public License v2 and must be provided, in source form, on request:

u-boot linux-arm-freescale busybox termcap util-linux udev e2fsprogs kobs-ng freetype glib dbus-l qt5 libfftw

The modules listed below are licenced under the GNU Lesser General Public License v2.1 and must be provided, in source form, on request:

kmod libalsa libgpg-error nettle libgcrypt gnutls libmicrohttpd libjwt libdaemon nss-mdns avahi

In addition to the GPL modules listed, this product also includes binaries derived from 3rd party open sources that have their own license requirements. Each module is listed below with their required Copyright statement and distribution conditions.

You may obtain the complete Corresponding Source Code from Adder for a period of three years after the last shipment of this product, which will be no earlier than 2028, by contacting support@adder.com or writing to:

Attn:ACD/Open Source Request, Adder Technology Ltd, Saxon Way, Bar Hill, Cambridge, CB23 8SL, United Kingdom

Please write "Source for product XXXXXXXX" in the subject line (where XXXXXXXX is the model and version number). This offer is valid to anyone in receipt of this information.

Module: libcv

Copyright (c) 2001, Andy Ritger aritger@nvidia.com All rights reserved. Redistribution and use in source and binary forms, with or without modification, are permitted provided that the following conditions are met:

Redistributions of source code must retain the above copyright notice, this list of conditions and the following disclaimer.

Redistributions in binary form must reproduce the above copyright notice, this list of conditions and the following disclaimer in the documentation and/or other materials provided with the distribution.

Neither the name of NVIDIA nor the names of its contributors may be used to endorse or promote products derived from this software without specific prior written permission.

THIS SOFTWARE IS PROVIDED BY THE COPYRIGHT HOLDERS AND CONTRIBUTORS "AS IS" AND ANY EXPRESS OR IMPLIED WARRANTIES, INCLUDING, BUT NOT LIMITED TO, THE IMPLIED WARRANTIES OF MERCHANTABILITY AND FITNESS FOR A PARTICULAR PURPOSE ARE DISCLAIMED. IN NO EVENT SHALL THE REGENTS OR CONTRIBUTORS

BE LIABLE FOR ANY DIRECT, INDIRECT, INCIDENTAL, SPECIAL, EXEMPLARY, OR CONSEQUENTIAL DAMAGES (INCLUDING, BUT NOT LIMITED TO, PROCUREMENT OF SUBSTITUTE GOODS OR SERVICES; LOSS OF USE, DATA, OR PROFITS; OR BUSINESS INTERRUPTION) HOWEVER CAUSED AND ON ANY THEORY OF LIABILITY, WHETHER IN CONTRACT, STRICT LIABILITY, OR TORT (INCLUDING NEGLIGENCE OR OTHERWISE) ARISING IN ANY WAY OUT OF THE USE OF THIS SOFTWARE, EVEN IF ADVISED OF THE POSSIBILITY OF SUCH DAMAGE.

This program is based on the Generalized Timing Formula (GTF TM) Standard Version: 1.0, Revision: 1.0

The GTF Document contains the following Copyright information:

Copyright (c) 1994, 1995, 1996 - Video Electronics Standards Association. Duplication of this document within VESA member companies for review purposes is permitted. All other rights reserved.

While every precaution has been taken in the preparation of this standard, the Video Electronics Standards Association and its contributors assume no responsibility for errors or omissions, and make no warranties, expressed or implied, of functionality of suitability for any purpose. The sample code contained within this standard may be used without restriction.

Module: openssl

LICENSE ISSUES

The OpenSSL toolkit stays under a dual license, i.e. both the conditions of the OpenSSL License and the original SSLeay license apply to the toolkit. See below for the actual license texts. Actually both licenses are BSD-style Open Source licenses. In case of any license issues related to OpenSSL please contact openssl-core@openssl.org.

OpenSSL License

/* =====

* Copyright (c) 1998-2011 The OpenSSL Project. All rights reserved.

* Redistribution and use in source and binary forms, with or without modification, are permitted provided that the following conditions are met:

* 1. Redistributions of source code must retain the above copyright notice, this list of conditions and the following disclaimer.

* 2. Redistributions in binary form must reproduce the above copyright notice, this list of conditions and the following disclaimer in the documentation and/or other materials provided with the distribution.

* 3. All advertising materials mentioning features or use of this software must display the following acknowledgment:
* "This product includes software developed by the OpenSSL Project for use in the OpenSSL Toolkit. (http://www.openssl.org/)"

* 4. The names "OpenSSL Toolkit" and "OpenSSL Project" must not be used to endorse or promote products derived from this software without prior written permission. For written permission, please contact openssl-core@openssl.org.

* 5. Products derived from this software may not be called "OpenSSL" nor may "OpenSSL" appear in their names without prior written permission of the OpenSSL Project.

* 6. Redistributions of any form whatsoever must retain the following acknowledgment:
* "This product includes software developed by the OpenSSL Project for use in the OpenSSL Toolkit (http://www.openssl.org/)"

* THIS SOFTWARE IS PROVIDED BY THE OPENSSL PROJECT "AS IS" AND ANY EXPRESS OR IMPLIED WARRANTIES, INCLUDING, BUT NOT LIMITED TO, THE IMPLIED WARRANTIES OF MERCHANTABILITY AND FITNESS FOR A PARTICULAR PURPOSE ARE DISCLAIMED. IN NO EVENT SHALL THE OPENSSL PROJECT OR ITS CONTRIBUTORS BE LIABLE FOR ANY DIRECT, INDIRECT, INCIDENTAL, SPECIAL, EXEMPLARY, OR CONSEQUENTIAL DAMAGES (INCLUDING, BUT NOT LIMITED TO, PROCUREMENT OF SUBSTITUTE GOODS OR SERVICES;

* LOSS OF USE, DATA, OR PROFITS; OR BUSINESS INTERRUPTION) HOWEVER CAUSED AND ON ANY THEORY OF LIABILITY, WHETHER IN CONTRACT, STRICT LIABILITY, OR TORT (INCLUDING NEGLIGENCE OR OTHERWISE) ARISING IN ANY WAY OUT OF THE USE OF THIS SOFTWARE, EVEN IF ADVISED OF THE POSSIBILITY OF SUCH DAMAGE.

* This product includes cryptographic software written by Eric Young (eay@cryptsoft.com). This product includes software written by Tim Hudson (tjh@cryptsoft.com).

*/

Original SSLeay License

/* Copyright (C) 1995-1998 Eric Young (eay@cryptsoft.com)

* All rights reserved.

* This package is an SSL implementation written by Eric Young (eay@cryptsoft.com).

* The implementation was written so as to conform with Netscapes SSL.

* This library is free for commercial and non-commercial use as long as the following conditions are aheared to. The following conditions apply to all code found in this distribution, be it the RC4, RSA, lhash, DES, etc., code; not just the SSL code. The SSL documentation included with this distribution is covered by the same copyright terms except that the holder is Tim Hudson (tjh@cryptsoft.com).

* Copyright remains Eric Young's, and as such any Copyright notices in the code are not to be removed.
* If this package is used in a product, Eric Young should be given attribution as the author of the parts of the library used.
* This can be in the form of a textual message at program startup or in documentation (online or textual) provided with the package.

* Redistribution and use in source and binary forms, with or without modification, are permitted provided that the following conditions are met:

* 1. Redistributions of source code must retain the copyright notice, this list of conditions and the following disclaimer.
* 2. Redistributions in binary form must reproduce the above copyright notice, this list of conditions and the following disclaimer in the documentation and/or other materials provided with the distribution.

* 3. All advertising materials mentioning features or use of this software must display the following acknowledgement:
* "This product includes cryptographic software written by Eric Young (eay@cryptsoft.com)"
* The word 'cryptographic' can be left out if the rouines from the library being used are not cryptographic related :-).

* 4. If you include any Windows specific code (or a derivative thereof) from the apps directory (application code) you must include an acknowledgement:
* "This product includes software written by Tim Hudson (tjh@cryptsoft.com)"

* THIS SOFTWARE IS PROVIDED BY ERIC YOUNG "AS IS" AND ANY EXPRESS OR IMPLIED WARRANTIES, INCLUDING, BUT NOT LIMITED TO, THE IMPLIED WARRANTIES OF MERCHANTABILITY AND FITNESS FOR A PARTICULAR PURPOSE ARE DISCLAIMED. IN NO EVENT SHALL THE AUTHOR OR CONTRIBUTORS BE LIABLE FOR ANY DIRECT, INDIRECT, INCIDENTAL, SPECIAL, EXEMPLARY, OR CONSEQUENTIAL DAMAGES (INCLUDING, BUT NOT LIMITED TO, PROCUREMENT OF SUBSTITUTE GOODS OR SERVICES; LOSS OF USE, DATA, OR PROFITS; OR BUSINESS INTERRUPTION) HOWEVER CAUSED AND ON ANY THEORY OF LIABILITY, WHETHER IN CONTRACT, STRICT LIABILITY, OR TORT (INCLUDING NEGLIGENCE OR OTHERWISE) ARISING IN ANY WAY OUT OF THE USE OF THIS SOFTWARE, EVEN IF ADVISED OF THE POSSIBILITY OF SUCH DAMAGE.

* The licence and distribution terms for any publically available version or

* derivative of this code cannot be changed. i.e. this code cannot simply be
 * copied and put under another distribution licence
 * [including the GNU Public Licence.]
 */

 - Module: libev

All files in libev are
 Copyright (c)2007,2008,2009,2010,2011,2012,2013 Marc Alexander Lehmann.

Redistribution and use in source and binary forms, with or without
 modification, are permitted provided that the following conditions are
 met:

* Redistributions of source code must retain the above copyright
 notice, this list of conditions and the following disclaimer.

* Redistributions in binary form must reproduce the above
 copyright notice, this list of conditions and the following
 disclaimer in the documentation and/or other materials provided
 with the distribution.

THIS SOFTWARE IS PROVIDED BY THE COPYRIGHT HOLDERS AND CONTRIBUTORS "AS
 IS" AND ANY EXPRESS OR IMPLIED WARRANTIES, INCLUDING, BUT NOT LIMITED TO, THE
 IMPLIED WARRANTIES OF MERCHANTABILITY AND FITNESS FOR A PARTICULAR
 PURPOSE ARE DISCLAIMED. IN NO EVENT SHALL THE COPYRIGHT OWNER OR
 CONTRIBUTORS BE LIABLE FOR ANY DIRECT, INDIRECT, INCIDENTAL, SPECIAL,
 EXEMPLARY, OR CONSEQUENTIAL DAMAGES (INCLUDING, BUT NOT LIMITED TO,
 PROCUREMENT OF SUBSTITUTE GOODS OR SERVICES; LOSS OF USE,
 DATA, OR PROFITS; OR BUSINESS INTERRUPTION) HOWEVER CAUSED AND ON ANY
 THEORY OF LIABILITY, WHETHER IN CONTRACT, STRICT LIABILITY, OR TORT
 (INCLUDING NEGLIGENCE OR OTHERWISE) ARISING IN ANY WAY OUT OF THE USE OF
 THIS SOFTWARE, EVEN IF ADVISED OF THE POSSIBILITY OF SUCH DAMAGE.

 - Module: libaes

Copyright (c) 1998-2008, Brian Gladman, Worcester, UK. All rights reserved.

LICENSE TERMS

The redistribution and use of this software (with or without changes) is allowed without the
 payment of fees or royalties provided that:

1. source code distributions include the above copyright notice, this
 list of conditions and the following disclaimer;
2. binary distributions include the above copyright notice, this list
 of conditions and the following disclaimer in their documentation;
3. the name of the copyright holder is not used to endorse products
 built using this software without specific written permission.

DISCLAIMER

This software is provided 'as is' with no explicit or implied warranties
 in respect of its properties, including, but not limited to, correctness
 and/or fitness for purpose.

 - Module: libupnp

Copyright (c) 2000-2003 Intel Corporation
 All rights reserved.

Redistribution and use in source and binary forms, with or without
 modification, are permitted provided that the following conditions are met:

* Redistributions of source code must retain the above copyright notice,
 this list of conditions and the following disclaimer:

* Redistributions in binary form must reproduce the above copyright notice, this list of conditions
 and the following disclaimer in the documentation and/or other materials provided with the
 distribution.

* Neither name of Intel Corporation nor the names of its contributors may be used to endorse
 or promote products derived from this software without specific prior written permission.

THIS SOFTWARE IS PROVIDED BY THE COPYRIGHT HOLDERS AND CONTRIBUTORS "AS
 IS" AND ANY EXPRESS OR IMPLIED WARRANTIES, INCLUDING, BUT NOT LIMITED TO, THE
 IMPLIED WARRANTIES OF MERCHANTABILITY AND FITNESS FOR A PARTICULAR
 PURPOSE ARE DISCLAIMED. IN NO EVENT SHALL INTEL OR CONTRIBUTORS BE LIABLE
 FOR ANY DIRECT, INDIRECT, INCIDENTAL, SPECIAL, EXEMPLARY, OR CONSEQUENTIAL
 DAMAGES (INCLUDING, BUT NOT LIMITED TO, PROCUREMENT OF SUBSTITUTE GOODS
 OR SERVICES; LOSS OF USE, DATA, OR PROFITS; OR BUSINESS INTERRUPTION) HOWEVER
 CAUSED AND ON ANY THEORY OF LIABILITY, WHETHER IN CONTRACT, STRICT
 LIABILITY, OR TORT (INCLUDING NEGLIGENCE OR OTHERWISE) ARISING IN ANY WAY
 OUT OF THE USE OF THIS SOFTWARE, EVEN IF ADVISED OF THE POSSIBILITY OF SUCH
 DAMAGE.

 - Module: libjpeg

This software is based in part on the work of the Independent JPEG Group.

 - Module: icu

ICU License - ICU 1.8.1 and later

COPYRIGHT AND PERMISSION NOTICE

Copyright (c) 1995-2016 International Business Machines Corporation and others

All rights reserved.

Permission is hereby granted, free of charge, to any person obtaining a copy of this software and
 associated documentation files (the "Software"), to deal in the Software without restriction,
 including without limitation the rights to use, copy, modify, merge, publish, distribute, and/or sell
 copies of the Software, and to permit persons to whom the Software is furnished to do so,
 provided that the above copyright notice(s) and this permission notice appear in all copies of the
 Software and that both the above copyright notice(s) and this permission notice appear in
 supporting documentation.

THE SOFTWARE IS PROVIDED "AS IS", WITHOUT WARRANTY OF ANY KIND,
 EXPRESS OR IMPLIED, INCLUDING BUT NOT LIMITED TO THE WARRANTIES OF
 MERCHANTABILITY, FITNESS FOR A PARTICULAR PURPOSE AND NONINFRINGEMENT OF
 THIRD PARTY RIGHTS. IN NO EVENT SHALL THE COPYRIGHT HOLDER OR HOLDERS
 INCLUDED IN THIS NOTICE BE LIABLE FOR ANY CLAIM, OR ANY SPECIAL INDIRECT OR
 CONSEQUENTIAL DAMAGES, OR ANY DAMAGES WHATSOEVER RESULTING FROM LOSS
 OF USE, DATA OR PROFITS, WHETHER IN AN ACTION OF CONTRACT, NEGLIGENCE OR
 OTHER TORTIOUS ACTION, ARISING OUT OF OR IN CONNECTION WITH THE USE OR
 PERFORMANCE OF THIS SOFTWARE.

Except as contained in this notice, the name of a copyright holder shall not be used in advertising
 or otherwise to promote the sale, use or other dealings in this Software without prior written
 authorization of the copyright holder.

All trademarks and registered trademarks mentioned herein are the
 property of their respective owners.

Third-Party Software Licenses

This section contains third-party software notices and/or additional terms for licensed
 third-party software components included within ICU libraries.

I. Unicode Data Files and Software

COPYRIGHT AND PERMISSION NOTICE

Copyright © 1991-2016 Unicode, Inc. All rights reserved.
 Distributed under the Terms of Use in
<http://www.unicode.org/copyright.html>.

Permission is hereby granted, free of charge, to any person obtaining a copy of the Unicode data
 files and any associated documentation (the "Data Files") or Unicode software and any associated
 documentation (the "Software") to deal in the Data Files or Software without restriction,
 including without limitation the rights to use, copy, modify, merge, publish, distribute, and/or sell
 copies of the Data Files or Software, and to permit persons to whom the Data Files or Software
 are furnished to do so, provided that

- (a) this copyright and permission notice appear with all copies
 of the Data Files or Software,
- (b) this copyright and permission notice appear in associated documentation, and
- (c) there is clear notice in each modified Data File or in the Software as well as in the
 documentation associated with the Data File(s) or Software that the data or software has been
 modified.

THE DATA FILES AND SOFTWARE ARE PROVIDED "AS IS", WITHOUT WARRANTY OF ANY
 KIND, EXPRESS OR IMPLIED, INCLUDING BUT NOT LIMITED TO THE
 WARRANTIES OF MERCHANTABILITY, FITNESS FOR A PARTICULAR PURPOSE AND
 NONINFRINGEMENT OF THIRD PARTY RIGHTS. IN NO EVENT SHALL THE COPYRIGHT
 HOLDER OR HOLDERS INCLUDED IN THIS NOTICE BE LIABLE FOR ANY CLAIM, OR ANY
 SPECIAL INDIRECT OR CONSEQUENTIAL DAMAGES, OR ANY DAMAGES WHATSOEVER
 RESULTING FROM LOSS OF USE, DATA OR PROFITS, WHETHER IN AN ACTION OF
 CONTRACT, NEGLIGENCE OR OTHER
 TORTIOUS ACTION, ARISING OUT OF OR IN CONNECTION WITH THE USE OR
 PERFORMANCE OF THE DATA FILES OR SOFTWARE.

Except as contained in this notice, the name of a copyright holder shall not be used in advertising
 or otherwise to promote the sale, use or other dealings in these Data Files or Software without
 prior written authorization of the copyright holder.

2. Chinese/Japanese Word Break Dictionary Data (cjdict.txt)

The Google Chrome software developed by Google is licensed under
 # the BSD license. Other software included in this distribution is
 # provided under other licenses, as set forth below.
 #

The BSD License
 # <http://opensource.org/licenses/bsd-license.php>
 # Copyright (C) 2006-2008, Google Inc.
 #

All rights reserved.
 #

Redistribution and use in source and binary forms, with or without
 # modification, are permitted provided that the following conditions are met:
 #

Redistributions of source code must retain the above copyright notice,
 # this list of conditions and the following disclaimer.
 # Redistributions in binary form must reproduce the above

copyright notice, this list of conditions and the following
 # disclaimer in the documentation and/or other materials provided with
 # the distribution.
 # Neither the name of Google Inc. nor the names of its

contributors may be used to endorse or promote products derived from
 # this software without specific prior written permission.
 #

THIS SOFTWARE IS PROVIDED BY THE COPYRIGHT HOLDERS AND
 # CONTRIBUTORS "AS IS" AND ANY EXPRESS OR IMPLIED WARRANTIES,
 # INCLUDING, BUT NOT LIMITED TO, THE IMPLIED WARRANTIES OF
 # MERCHANTABILITY AND FITNESS FOR A PARTICULAR PURPOSE ARE
 # DISCLAIMED. IN NO EVENT SHALL THE COPYRIGHT OWNER OR CONTRIBUTORS BE
 # LIABLE FOR ANY DIRECT, INDIRECT, INCIDENTAL, SPECIAL, EXEMPLARY, OR
 # CONSEQUENTIAL DAMAGES (INCLUDING, BUT NOT LIMITED TO, PROCUREMENT OF
 # SUBSTITUTE GOODS OR SERVICES; LOSS OF USE, DATA, OR PROFITS; OR
 # BUSINESS INTERRUPTION) HOWEVER CAUSED AND ON ANY THEORY OF
 # LIABILITY, WHETHER IN CONTRACT, STRICT LIABILITY, OR TORT (INCLUDING
 # NEGLIGENCE OR OTHERWISE) ARISING IN ANY WAY OUT OF THE USE OF THIS
 # SOFTWARE, EVEN IF ADVISED OF THE POSSIBILITY OF SUCH DAMAGE.

```
#
# The word list in cjdict.txt are generated by combining three word lists
# listed below with further processing for compound word breaking. The
# frequency is generated with an iterative training against Google web
# corpora.
#
# * Libtabe (Chinese)
# - https://sourceforge.net/project/?group_id=1519
# - Its license terms and conditions are shown below.
#
# * IPADIC (Japanese)
# - http://chasen.aist-nara.ac.jp/chasen/distribution.html
# - Its license terms and conditions are shown below.
#
# -----COPYING.libtabe ---- BEGIN-----
#
# /*
# * Copyright (c) 1999 TaBE Project.
# * Copyright (c) 1999 Pai-Hsiang Hsiao.
# * All rights reserved.
#
# * Redistribution and use in source and binary forms, with or without
# * modification, are permitted provided that the following conditions
# * are met:
#
# * . Redistributions of source code must retain the above copyright
# * notice, this list of conditions and the following disclaimer.
# * . Redistributions in binary form must reproduce the above copyright
# * notice, this list of conditions and the following disclaimer in
# * the documentation and/or other materials provided with the distribution.
# * . Neither the name of the TaBE Project nor the names of its
# * contributors may be used to endorse or promote products derived
# * from this software without specific prior written permission.
#
# * THIS SOFTWARE IS PROVIDED BY THE COPYRIGHT HOLDERS AND
CONTRIBUTORS
# * "AS IS" AND ANY EXPRESS OR IMPLIED WARRANTIES, INCLUDING, BUT NOT
# * LIMITED TO, THE IMPLIED WARRANTIES OF MERCHANTABILITY AND FITNESS
# * FOR A PARTICULAR PURPOSE ARE DISCLAIMED. IN NO EVENT SHALL THE
# * REGENTS OR CONTRIBUTORS BE LIABLE FOR ANY DIRECT, INDIRECT,
# * INCIDENTAL, SPECIAL, EXEMPLARY, OR CONSEQUENTIAL DAMAGES
# * (INCLUDING, BUT NOT LIMITED TO, PROCUREMENT OF SUBSTITUTE GOODS OR
# * SERVICES; LOSS OF USE, DATA, OR PROFITS; OR BUSINESS INTERRUPTION)
# * HOWEVER CAUSED AND ON ANY THEORY OF LIABILITY, WHETHER IN CONTRACT,
# * STRICT LIABILITY, OR TORT (INCLUDING NEGLIGENCE OR OTHERWISE)
# * ARISING IN ANY WAY OUT OF THE USE OF THIS SOFTWARE, EVEN IF ADVISED OF
THE POSSIBILITY OF SUCH DAMAGE.
# */
#
# /*
# * Copyright (c) 1999 Computer Systems and Communication Lab,
# * Institute of Information Science, Academia
# * Sinica. All rights reserved.
#
# * Redistribution and use in source and binary forms, with or without
# * modification, are permitted provided that the following conditions
# * are met:
#
# * . Redistributions of source code must retain the above copyright
# * notice, this list of conditions and the following disclaimer.
# * . Redistributions in binary form must reproduce the above copyright
# * notice, this list of conditions and the following disclaimer in
# * the documentation and/or other materials provided with the
# * distribution.
# * . Neither the name of the Computer Systems and Communication Lab
# * nor the names of its contributors may be used to endorse or
# * promote products derived from this software without specific
# * prior written permission.
#
# * THIS SOFTWARE IS PROVIDED BY THE COPYRIGHT HOLDERS AND
CONTRIBUTORS
# * "AS IS" AND ANY EXPRESS OR IMPLIED WARRANTIES, INCLUDING, BUT NOT
# * LIMITED TO, THE IMPLIED WARRANTIES OF MERCHANTABILITY AND FITNESS
# * FOR A PARTICULAR PURPOSE ARE DISCLAIMED. IN NO EVENT SHALL THE
```

```
# * REGENTS OR CONTRIBUTORS BE LIABLE FOR ANY DIRECT, INDIRECT,
# * INCIDENTAL, SPECIAL, EXEMPLARY, OR CONSEQUENTIAL DAMAGES
# * (INCLUDING, BUT NOT LIMITED TO, PROCUREMENT OF SUBSTITUTE GOODS OR
# * SERVICES; LOSS OF USE, DATA, OR PROFITS; OR BUSINESS INTERRUPTION)
# * HOWEVER CAUSED AND ON ANY THEORY OF LIABILITY, WHETHER IN CONTRACT,
# * STRICT LIABILITY, OR TORT (INCLUDING NEGLIGENCE OR OTHERWISE)
# * ARISING IN ANY WAY OUT OF THE USE OF THIS SOFTWARE, EVEN IF ADVISED
# * OF THE POSSIBILITY OF SUCH DAMAGE.
# */
#
# Copyright 1996 Chih-Hao Tsai @ Beckman Institute,
# University of Illinois
# c-tsay4@uiuc.edu http://casper.beckman.uiuc.edu/~c-tsay4
#
# Copyright 2000, 2001, 2002, 2003 Nara Institute of Science
# and Technology. All Rights Reserved.
#
# Use, reproduction, and distribution of this software is permitted.
# Any copy of this software, whether in its original form or modified,
# must include both the above copyright notice and the following
# paragraphs.
#
# Nara Institute of Science and Technology (NAIST),
# the copyright holders, disclaims all warranties with regard to this
# software, including all implied warranties of merchantability and
# fitness, in no event shall NAIST be liable for
# any special, indirect or consequential damages or any damages
# whatsoever resulting from loss of use, data or profits, whether in an
# action of contract, negligence or other tortious action, arising out
# of or in connection with the use or performance of this software.
#
# A large portion of the dictionary entries
# originate from ICOT Free Software. The following conditions for ICOT
# Free Software applies to the current dictionary as well.
#
# Each User may also freely distribute the Program, whether in its
# original form or modified, to any third party or parties, PROVIDED
# that the provisions of Section 3 ("NO WARRANTY") will ALWAYS appear
# on, or be attached to, the Program, which is distributed substantially
# in the same form as set out herein and that such intended
# distribution, if actually made, will neither violate or otherwise
# contravene any of the laws and regulations of the countries having
# jurisdiction over the User or the intended distribution itself.
#
# NO WARRANTY
#
# The program was produced on an experimental basis in the course of the
# research and development conducted during the project and is provided
# to users as so produced on an experimental basis. Accordingly, the
# program is provided without any warranty whatsoever, whether express,
# implied, statutory or otherwise. The term "warranty" used herein
# includes, but is not limited to, any warranty of the quality,
# performance, merchantability and fitness for a particular purpose of
# the program and the nonexistence of any infringement or violation of
# any right of any third party.
#
# Each user of the program will agree and understand, and be deemed to
# have agreed and understood, that there is no warranty whatsoever for
# the program and, accordingly, the entire risk arising from or
# otherwise connected with the program is assumed by the user.
#
# Therefore, neither ICOT, the copyright holder, or any other
# organization that participated in or was otherwise related to the
# development of the program and their respective officials, directors,
# officers and other employees shall be held liable for any and all
# damages, including, without limitation, general, special, incidental
# and consequential damages, arising out of or otherwise in connection
# with the use or inability to use the program or any product, material
# or result produced or otherwise obtained by using the program,
# regardless of whether they have been advised of, or otherwise had
# knowledge of, the possibility of such damages at any time during the
# project or thereafter. Each user will be deemed to have agreed to the
# foregoing by his or her commencement of use of the program. The term
# "use" as used herein includes, but is not limited to, the use,
```

```
# modification, copying and distribution of the program and the
# production of secondary products from the program.
#
# In the case where the program, whether in its original form or
# modified, was distributed or delivered to or received by a user from
# any person, organization or entity other than ICOT, unless it makes or
# grants independently of ICOT any specific warranty to the user in
# writing, such person, organization or entity, will also be exempted
# from and not be held liable to the user for any such damages as noted
# above as far as the program is concerned.
#
3. Lao Word Break Dictionary Data (laodict.txt)
#
# Copyright (c) 2013 International Business Machines Corporation
# and others. All Rights Reserved.
#
# Project: http://code.google.com/p/lao-dictionary/
# Dictionary: http://lao-dictionary.googlecode.com/git/Lao-Dictionary.txt
# License: http://lao-dictionary.googlecode.com/git/Lao-Dictionary-LICENSE.txt
#
# This file is derived from the above dictionary, with slight
# modifications.
# -----
# Copyright (C) 2013 Brian Eugene Wilson, Robert Martin Campbell.
# All rights reserved.
#
# Redistribution and use in source and binary forms, with or without
# modification,
# are permitted provided that the following conditions are met:
#
# Redistributions of source code must retain the above copyright notice, this
# list of conditions and the following disclaimer. Redistributions in
# binary form must reproduce the above copyright notice, this list of
# conditions and the following disclaimer in the documentation and/or
# other materials provided with the distribution.
#
# THIS SOFTWARE IS PROVIDED BY THE COPYRIGHT HOLDERS AND CONTRIBUTORS
# "AS IS" AND ANY EXPRESS OR IMPLIED WARRANTIES, INCLUDING, BUT NOT
# LIMITED TO, THE IMPLIED WARRANTIES OF MERCHANTABILITY AND FITNESS
# FOR A PARTICULAR PURPOSE ARE DISCLAIMED. IN NO EVENT SHALL THE
# COPYRIGHT HOLDER OR CONTRIBUTORS BE LIABLE FOR ANY DIRECT,
# INDIRECT, INCIDENTAL, SPECIAL, EXEMPLARY, OR CONSEQUENTIAL DAMAGES
# (INCLUDING, BUT NOT LIMITED TO, PROCUREMENT OF SUBSTITUTE GOODS OR
# SERVICES; LOSS OF USE, DATA, OR PROFITS; OR BUSINESS INTERRUPTION)
# HOWEVER CAUSED AND ON ANY THEORY OF LIABILITY, WHETHER IN CONTRACT,
# STRICT LIABILITY, OR TORT (INCLUDING NEGLIGENCE OR OTHERWISE)
# ARISING IN ANY WAY OUT OF THE USE OF THIS SOFTWARE, EVEN IF ADVISED
# OF THE POSSIBILITY OF SUCH DAMAGE.
4. Burmese Word Break Dictionary Data (burmesdict.txt)
#
# Copyright (c) 2014 International Business Machines Corporation
# and others. All Rights Reserved.
#
# This list is part of a project hosted at:
# github.com/kanyawtech/myanmar-karen-word-lists
#
# -----
# Copyright (c) 2013, LeRoy Benjamin Sharon
# All rights reserved.
#
# Redistribution and use in source and binary forms, with or without
# modification, are permitted provided that the following conditions
# are met: Redistributions of source code must retain the above
# copyright notice, this list of conditions and the following
# disclaimer. Redistributions in binary form must reproduce the
# above copyright notice, this list of conditions and the following
# disclaimer in the documentation and/or other materials provided
# with the distribution.
#
# Neither the name Myanmar Karen Word Lists, nor the names of its
# contributors may be used to endorse or promote products derived
# from this software without specific prior written permission.
#
```

```
# THIS SOFTWARE IS PROVIDED BY THE COPYRIGHT HOLDERS AND
# CONTRIBUTORS "AS IS" AND ANY EXPRESS OR IMPLIED WARRANTIES,
# INCLUDING, BUT NOT LIMITED TO, THE IMPLIED WARRANTIES OF
# MERCHANTABILITY AND FITNESS FOR A PARTICULAR PURPOSE ARE
# DISCLAIMED. IN NO EVENT SHALL THE COPYRIGHT HOLDER OR CONTRIBUTORS
# BE LIABLE FOR ANY DIRECT, INDIRECT, INCIDENTAL, SPECIAL,
# EXEMPLARY, OR CONSEQUENTIAL DAMAGES (INCLUDING, BUT NOT LIMITED
# TO, PROCUREMENT OF SUBSTITUTE GOODS OR SERVICES; LOSS OF USE,
# DATA, OR PROFITS; OR BUSINESS INTERRUPTION) HOWEVER CAUSED AND ON
# ANY THEORY OF LIABILITY, WHETHER IN CONTRACT, STRICT LIABILITY, OR
# TORT (INCLUDING NEGLIGENCE OR OTHERWISE) ARISING IN ANY WAY OUT OF
# THE USE OF THIS SOFTWARE, EVEN IF ADVISED OF THE POSSIBILITY OF
# SUCH DAMAGE.
# -----
```

5. Time Zone Database

ICU uses the public domain data and code derived from Time Zone Database for its time zone support. The ownership of the TZ database is explained in BCP 175: Procedure for Maintaining the Time Zone Database section 7.

7. Database Ownership

```
#
# The TZ database itself is not an IETF Contribution or an IETF
# document. Rather it is a pre-existing and regularly updated work
# that is in the public domain, and is intended to remain in the
# public domain. Therefore, BCPs 78 [RFC5378] and 79 [RFC3979] do
# not apply to the TZ Database or contributions that individuals make
# to it. Should any claims be made and substantiated against the TZ
# Database, the organization that is providing the IANA
# Considerations defined in this RFC, under the memorandum of
# understanding with the IETF, currently ICANN, may act in accordance
# with all competent court orders. No ownership claims will be made
# by ICANN or the IETF Trust on the database or the code. Any person
# making a contribution to the database or code waives all rights to
# future claims in that contribution or in the TZ Database.
```

```
-----
- Module: mtdev
-----
```

mtdev - Multitouch Protocol Translation Library (MIT license)

Copyright (C) 2010 Henrik Rydberg <rydberg@euromail.se>
Copyright (C) 2010 Canonical Ltd.

Permission is hereby granted, free of charge, to any person obtaining a copy of this software and associated documentation files (the "Software"), to deal in the Software without restriction, including without limitation the rights to use, copy, modify, merge, publish, distribute, sublicense, and/or sell copies of the Software, and to permit persons to whom the Software is furnished to do so, subject to the following conditions:

The above copyright notice and this permission notice (including the next paragraph) shall be included in all copies or substantial portions of the Software.

THE SOFTWARE IS PROVIDED "AS IS", WITHOUT WARRANTY OF ANY KIND, EXPRESS OR IMPLIED, INCLUDING BUT NOT LIMITED TO THE WARRANTIES OF MERCHANTABILITY, FITNESS FOR A PARTICULAR PURPOSE AND NONINFRINGEMENT. IN NO EVENT SHALL THE AUTHORS OR COPYRIGHT HOLDERS BE LIABLE FOR ANY CLAIM, DAMAGES OR OTHER LIABILITY, WHETHER IN AN ACTION OF CONTRACT, TORT OR OTHERWISE, ARISING FROM, OUT OF OR IN CONNECTION WITH THE SOFTWARE OR THE USE OR OTHER DEALINGS IN THE SOFTWARE.

```
-----
- Module: libevdev
-----
```

Copyright © 2013 Red Hat, Inc.
Copyright © 2013 David Herrmann <dh.herrmann@gmail.com>

Permission to use, copy, modify, distribute, and sell this software and its documentation for any purpose is hereby granted without fee, provided that the above copyright notice appear in all copies and that both that copyright notice and this permission notice appear in supporting documentation, and that the name of the copyright holders not be used in advertising or publicity pertaining to distribution of the software without specific, written prior permission. The copyright holders make no representations about the suitability of this software for any purpose. It is provided "as is" without express or implied warranty.

THE COPYRIGHT HOLDERS DISCLAIM ALL WARRANTIES WITH REGARD TO THIS SOFTWARE, INCLUDING ALL IMPLIED WARRANTIES OF MERCHANTABILITY AND FITNESS, IN NO EVENT SHALL THE COPYRIGHT HOLDERS BE LIABLE FOR ANY SPECIAL, INDIRECT OR CONSEQUENTIAL DAMAGES OR ANY DAMAGES WHATSOEVER RESULTING FROM LOSS OF USE, DATA OR PROFITS, WHETHER IN AN ACTION OF CONTRACT, NEGLIGENCE OR OTHER TORTIOUS ACTION, ARISING OUT OF OR IN CONNECTION WITH THE USE OR PERFORMANCE OF THIS SOFTWARE.

The following license is from a Linux kernel header file and there is no GPL code this package links to.

Copyright (c) 1999-2002 Vojtech Pavlik

This program is free software; you can redistribute it and/or modify it under the terms of the GNU General Public License version 2 as published by the Free Software Foundation.

```
-----
- Module: libinput
-----
```

Copyright © 2006-2009 Simon Thum
Copyright © 2008-2012 Kristian Høgsberg
Copyright © 2010-2012 Intel Corporation
Copyright © 2010-2011 Benjamin Franzke
Copyright © 2011-2012 Collabora, Ltd.
Copyright © 2013-2014 Jonas Ådahl
Copyright © 2013-2015 Red Hat, Inc.

Permission is hereby granted, free of charge, to any person obtaining a copy of this software and associated documentation files (the "Software"), to deal in the Software without restriction, including without limitation the rights to use, copy, modify, merge, publish, distribute, sublicense, and/or sell copies of the Software, and to permit persons to whom the Software is furnished to do so, subject to the following conditions:

The above copyright notice and this permission notice (including the next paragraph) shall be included in all copies or substantial portions of the Software.

THE SOFTWARE IS PROVIDED "AS IS", WITHOUT WARRANTY OF ANY KIND, EXPRESS OR IMPLIED, INCLUDING BUT NOT LIMITED TO THE WARRANTIES OF MERCHANTABILITY, FITNESS FOR A PARTICULAR PURPOSE AND NONINFRINGEMENT. IN NO EVENT SHALL THE AUTHORS OR COPYRIGHT HOLDERS BE LIABLE FOR ANY CLAIM, DAMAGES OR OTHER LIABILITY, WHETHER IN AN ACTION OF CONTRACT, TORT OR OTHERWISE, ARISING FROM, OUT OF OR IN CONNECTION WITH THE SOFTWARE OR THE USE OR OTHER DEALINGS IN THE SOFTWARE.

libinput ships a copy of the GPL-licensed Linux kernel's linux/input.h header file. [1] This does not make libinput GPL.
This copy is provided to provide consistent behavior regardless which kernel version libinput is compiled against. The header is used during compilation only, libinput does not link against GPL libraries.

[1] <http://cgit.freedesktop.org/wayland/libinput/tree/include/linux/input.h>

```
-----
- Module: xkeyboard-config
-----
```

Copyright 1996 by Joseph Moss
Copyright (C) 2002-2007 Free Software Foundation, Inc.
Copyright (C) Dmitry Golubev <lastguru@mail.ru>, 2003-2004
Copyright (C) 2004, Gregory Mokhin <mokhin@bog.msu.ru>
Copyright (C) 2006 Erdal Ronahi

Permission to use, copy, modify, distribute, and sell this software and its documentation for any purpose is hereby granted without fee, provided that the above copyright notice appear in all copies and that both that copyright notice and this permission notice appear in supporting documentation, and that the name of the copyright holder(s) not be used in advertising or publicity pertaining to distribution of the software without specific, written prior permission. The copyright holder(s) makes no representations about the suitability of this software for any purpose. It is provided "as is" without express or implied warranty.

THE COPYRIGHT HOLDER(S) DISCLAIMS ALL WARRANTIES WITH REGARD TO THIS SOFTWARE, INCLUDING ALL IMPLIED WARRANTIES OF MERCHANTABILITY AND FITNESS, IN NO EVENT SHALL THE COPYRIGHT HOLDER(S) BE LIABLE FOR ANY SPECIAL, INDIRECT OR CONSEQUENTIAL DAMAGES OR ANY DAMAGES WHATSOEVER RESULTING FROM LOSS OF USE, DATA OR PROFITS, WHETHER IN AN ACTION OF CONTRACT, NEGLIGENCE OR OTHER TORTIOUS ACTION, ARISING OUT OF OR IN CONNECTION WITH THE USE OR PERFORMANCE OF THIS SOFTWARE.

Copyright (c) 1996 Digital Equipment Corporation

Permission is hereby granted, free of charge, to any person obtaining a copy of this software and associated documentation files (the "Software"), to deal in the Software without restriction, including without limitation the rights to use, copy, modify, merge, publish, distribute, sublicense, and sell copies of the Software, and to permit persons to whom the Software is furnished to do so, subject to the following conditions:

The above copyright notice and this permission notice shall be included in all copies or substantial portions of the Software.

THE SOFTWARE IS PROVIDED "AS IS", WITHOUT WARRANTY OF ANY KIND, EXPRESS OR IMPLIED, INCLUDING BUT NOT LIMITED TO THE WARRANTIES OF MERCHANTABILITY, FITNESS FOR A PARTICULAR PURPOSE AND NONINFRINGEMENT. IN NO EVENT SHALL DIGITAL EQUIPMENT CORPORATION BE LIABLE FOR ANY CLAIM, DAMAGES OR OTHER LIABILITY, WHETHER IN AN ACTION OF CONTRACT, TORT OR OTHERWISE, ARISING FROM, OUT OF OR IN CONNECTION WITH THE SOFTWARE OR THE USE OR OTHER DEALINGS IN THE SOFTWARE.

Except as contained in this notice, the name of the Digital Equipment Corporation shall not be used in advertising or otherwise to promote the sale, use or other dealings in this Software without prior written authorization from Digital Equipment Corporation.

Copyright 1996, 1998 The Open Group

Permission to use, copy, modify, distribute, and sell this software and its documentation for any purpose is hereby granted without fee, provided that the above copyright notice appear in all copies and that both that copyright notice and this permission notice appear in supporting documentation.

The above copyright notice and this permission notice shall be included in all copies or substantial portions of the Software.

THE SOFTWARE IS PROVIDED "AS IS", WITHOUT WARRANTY OF ANY KIND, EXPRESS OR IMPLIED, INCLUDING BUT NOT LIMITED TO THE WARRANTIES OF MERCHANTABILITY, FITNESS FOR A PARTICULAR PURPOSE AND NONINFRINGEMENT. IN NO EVENT SHALL THE OPEN GROUP BE LIABLE FOR ANY CLAIM, DAMAGES OR OTHER LIABILITY, WHETHER IN AN ACTION OF CONTRACT, TORT OR OTHERWISE, ARISING FROM, OUT OF OR IN CONNECTION WITH THE SOFTWARE OR THE USE OR OTHER DEALINGS IN THE SOFTWARE.

Except as contained in this notice, the name of The Open Group shall not be used in advertising or otherwise to promote the sale, use or other dealings in this Software without prior written authorization

from The Open Group.
Copyright 2004-2005 Sun Microsystems, Inc. All rights reserved.

Permission is hereby granted, free of charge, to any person obtaining a copy of this software and associated documentation files (the "Software"), to deal in the Software without restriction, including without limitation the rights to use, copy, modify, merge, publish, distribute, sublicense, and/or sell copies of the Software, and to permit persons to whom the Software is furnished to do so, subject to the following conditions:

The above copyright notice and this permission notice (including the next paragraph) shall be included in all copies or substantial portions of the Software.

THE SOFTWARE IS PROVIDED "AS IS", WITHOUT WARRANTY OF ANY KIND, EXPRESS OR IMPLIED, INCLUDING BUT NOT LIMITED TO THE WARRANTIES OF MERCHANTABILITY, FITNESS FOR A PARTICULAR PURPOSE AND NONINFRINGEMENT. IN NO EVENT SHALL THE AUTHORS OR COPYRIGHT HOLDERS BE LIABLE FOR ANY CLAIM, DAMAGES OR OTHER LIABILITY, WHETHER IN AN ACTION OF CONTRACT, TORT OR OTHERWISE, ARISING FROM, OUT OF OR IN CONNECTION WITH THE SOFTWARE OR THE USE OR OTHER DEALINGS IN THE SOFTWARE.
Copyright (c) 1996 by Silicon Graphics Computer Systems, Inc.

Permission to use, copy, modify, and distribute this software and its documentation for any purpose and without fee is hereby granted, provided that the above copyright notice appear in all copies and that both that copyright notice and this permission notice appear in supporting documentation, and that the name of Silicon Graphics not be used in advertising or publicity pertaining to distribution of the software without specific prior written permission. Silicon Graphics makes no representation about the suitability of this software for any purpose. It is provided "as is" without any express or implied warranty.

SILICON GRAPHICS DISCLAIMS ALL WARRANTIES WITH REGARD TO THIS SOFTWARE, INCLUDING ALL IMPLIED WARRANTIES OF MERCHANTABILITY AND FITNESS FOR A PARTICULAR PURPOSE. IN NO EVENT SHALL SILICON GRAPHICS BE LIABLE FOR ANY SPECIAL, INDIRECT OR CONSEQUENTIAL DAMAGES OR ANY DAMAGES WHATSOEVER RESULTING FROM LOSS OF USE, DATA OR PROFITS, WHETHER IN AN ACTION OF CONTRACT, NEGLIGENCE OR OTHER TORTIOUS ACTION, ARISING OUT OF OR IN CONNECTION WITH THE USE OR PERFORMANCE OF THIS SOFTWARE.
Copyright (c) 1996 X Consortium

Permission is hereby granted, free of charge, to any person obtaining a copy of this software and associated documentation files (the "Software"), to deal in the Software without restriction, including without limitation the rights to use, copy, modify, merge, publish, distribute, sublicense, and/or sell copies of the Software, and to permit persons to whom the Software is furnished to do so, subject to the following conditions:

The above copyright notice and this permission notice shall be included in all copies or substantial portions of the Software.

THE SOFTWARE IS PROVIDED "AS IS", WITHOUT WARRANTY OF ANY KIND, EXPRESS OR IMPLIED, INCLUDING BUT NOT LIMITED TO THE WARRANTIES OF MERCHANTABILITY, FITNESS FOR A PARTICULAR PURPOSE AND NONINFRINGEMENT. IN NO EVENT SHALL THE X CONSORTIUM BE LIABLE FOR ANY CLAIM, DAMAGES OR OTHER LIABILITY, WHETHER IN AN ACTION OF CONTRACT, TORT OR OTHERWISE, ARISING FROM, OUT OF OR IN CONNECTION WITH THE SOFTWARE OR THE USE OR OTHER DEALINGS IN THE SOFTWARE.

Except as contained in this notice, the name of the X Consortium shall not be used in advertising or otherwise to promote the sale, use or other dealings in this Software without prior written authorization from the X Consortium.

Copyright (C) 2004, 2006 Ævar Arnfjörð Bjarmason <avarab@gmail.com>

Permission to use, copy, modify, distribute, and sell this software and its documentation for any purpose is hereby granted without fee, provided that the above copyright notice appear in all copies and that both that copyright notice and this permission notice appear in supporting documentation.

The above copyright notice and this permission notice shall be included in all copies or substantial portions of the Software.

THE SOFTWARE IS PROVIDED "AS IS", WITHOUT WARRANTY OF ANY KIND, EXPRESS OR IMPLIED, INCLUDING BUT NOT LIMITED TO THE WARRANTIES OF MERCHANTABILITY, FITNESS FOR A PARTICULAR PURPOSE AND NONINFRINGEMENT. IN NO EVENT SHALL THE OPEN GROUP BE LIABLE FOR ANY CLAIM, DAMAGES OR OTHER LIABILITY, WHETHER IN AN ACTION OF CONTRACT, TORT OR OTHERWISE, ARISING FROM, OUT OF OR IN CONNECTION WITH THE SOFTWARE OR THE USE OR OTHER DEALINGS IN THE SOFTWARE.

Except as contained in this notice, the name of a copyright holder shall not be used in advertising or otherwise to promote the sale, use or other dealings in this Software without prior written authorization of the copyright holder.

Copyright (C) 1999, 2000 by Anton Zinoviev <anton@lml.bas.bg>

This software may be used, modified, copied, distributed, and sold, in both source and binary form provided that the above copyright and these terms are retained. Under no circumstances is the author responsible for the proper functioning of this software, nor does the author assume any responsibility for damages incurred with its use.

Permission is granted to anyone to use, distribute and modify this file in any way, provided that the above copyright notice is left intact and the author of the modification summarizes the changes in this header.

This file is distributed without any expressed or implied warranty.

-
- Module: libxkbcommon

Copyright © 2009-2012, 2016 Daniel Stone
Copyright © 2012 Ran Benita <ran234@gmail.com>
Copyright © 2010, 2012 Intel Corporation
Copyright © 2008, 2009 Dan Nicholson
Copyright © 2010 Francisco Jerez <currojerez@riseup.net>

Permission is hereby granted, free of charge, to any person obtaining a copy of this software and associated documentation files (the "Software"), to deal in the Software without restriction, including without limitation the rights to use, copy, modify, merge, publish, distribute, sublicense, and/or sell copies of the Software, and to permit persons to whom the Software is furnished to do so, subject to the following conditions:

The above copyright notice and this permission notice (including the next paragraph) shall be included in all copies or substantial portions of the Software.

THE SOFTWARE IS PROVIDED "AS IS", WITHOUT WARRANTY OF ANY KIND, EXPRESS OR IMPLIED, INCLUDING BUT NOT LIMITED TO THE WARRANTIES OF MERCHANTABILITY, FITNESS FOR A PARTICULAR PURPOSE AND NONINFRINGEMENT. IN NO EVENT SHALL THE AUTHORS OR COPYRIGHT HOLDERS BE LIABLE FOR ANY CLAIM, DAMAGES OR OTHER LIABILITY, WHETHER IN AN ACTION OF CONTRACT, TORT OR OTHERWISE, ARISING FROM, OUT OF OR IN CONNECTION WITH THE SOFTWARE OR THE USE OR OTHER DEALINGS IN THE SOFTWARE.

Copyright 1985, 1987, 1988, 1990, 1998 The Open Group

Permission is hereby granted, free of charge, to any person obtaining a copy of this software and associated documentation files (the "Software"), to deal in the Software without restriction, including without limitation the rights to use, copy, modify, merge, publish, distribute, sublicense, and/or sell copies of the Software, and to permit persons to whom the Software is furnished to do so, subject to the following conditions:

The above copyright notice and this permission notice shall be included in all copies or substantial portions of the Software.

THE SOFTWARE IS PROVIDED "AS IS", WITHOUT WARRANTY OF ANY KIND, EXPRESS OR IMPLIED, INCLUDING BUT NOT LIMITED TO THE WARRANTIES OF MERCHANTABILITY, FITNESS FOR A PARTICULAR PURPOSE AND NONINFRINGEMENT. IN NO EVENT SHALL THE AUTHORS BE LIABLE FOR ANY CLAIM, DAMAGES OR OTHER LIABILITY, WHETHER IN AN ACTION OF CONTRACT, TORT OR OTHERWISE, ARISING FROM, OUT OF OR IN CONNECTION WITH THE SOFTWARE OR THE USE OR OTHER DEALINGS IN THE SOFTWARE.

Except as contained in this notice, the names of the authors or their institutions shall not be used in advertising or otherwise to promote the sale, use or other dealings in this Software without prior written authorization from the authors.

Copyright (c) 1993, 1994, 1995, 1996 by Silicon Graphics Computer Systems, Inc.

Permission to use, copy, modify, and distribute this software and its documentation for any purpose and without fee is hereby granted, provided that the above copyright notice appear in all copies and that both that copyright notice and this permission notice appear in supporting documentation, and that the name of Silicon Graphics not be used in advertising or publicity pertaining to distribution of the software without specific prior written permission. Silicon Graphics makes no representation about the suitability of this software for any purpose. It is provided "as is" without any express or implied warranty.

SILICON GRAPHICS DISCLAIMS ALL WARRANTIES WITH REGARD TO THIS SOFTWARE, INCLUDING ALL IMPLIED WARRANTIES OF MERCHANTABILITY AND FITNESS FOR A PARTICULAR PURPOSE. IN NO EVENT SHALL SILICON GRAPHICS BE LIABLE FOR ANY SPECIAL, INDIRECT OR CONSEQUENTIAL DAMAGES OR ANY DAMAGES WHATSOEVER RESULTING FROM LOSS OF USE, DATA OR PROFITS, WHETHER IN AN ACTION OF CONTRACT, NEGLIGENCE OR OTHER TORTIOUS ACTION, ARISING OUT OF OR IN CONNECTION WITH THE USE OR PERFORMANCE OF THIS SOFTWARE.

Copyright 1987, 1988 by Digital Equipment Corporation, Maynard, Massachusetts.

All Rights Reserved

Permission to use, copy, modify, and distribute this software and its documentation for any purpose and without fee is hereby granted, provided that the above copyright notice appear in all copies and that both that copyright notice and this permission notice appear in supporting documentation, and that the name of Digital not be used in advertising or publicity pertaining to distribution of the software without specific, written prior permission.

DIGITAL DISCLAIMS ALL WARRANTIES WITH REGARD TO THIS SOFTWARE, INCLUDING ALL IMPLIED WARRANTIES OF MERCHANTABILITY AND FITNESS, IN NO EVENT SHALL DIGITAL BE LIABLE FOR ANY SPECIAL, INDIRECT OR CONSEQUENTIAL DAMAGES OR ANY DAMAGES WHATSOEVER RESULTING FROM LOSS OF USE, DATA OR PROFITS, WHETHER IN AN ACTION OF CONTRACT, NEGLIGENCE OR OTHER TORTIOUS ACTION, ARISING OUT OF OR IN CONNECTION WITH THE USE OR PERFORMANCE OF THIS SOFTWARE.

Copyright (C) 2011 Joseph Adams <joeyadams3.14159@gmail.com>

Permission is hereby granted, free of charge, to any person obtaining a copy of this software and associated documentation files (the "Software"), to deal in the Software without restriction, including without limitation the rights to use, copy, modify, merge, publish, distribute, sublicense, and/or sell copies of the Software, and to permit persons to whom the Software is furnished to do so, subject to the following conditions:

The above copyright notice and this permission notice shall be included in all copies or substantial portions of the Software.

THE SOFTWARE IS PROVIDED "AS IS", WITHOUT WARRANTY OF ANY KIND, EXPRESS OR IMPLIED, INCLUDING BUT NOT LIMITED TO THE WARRANTIES OF MERCHANTABILITY, FITNESS FOR A PARTICULAR PURPOSE AND NONINFRINGEMENT. IN NO EVENT SHALL THE AUTHORS OR COPYRIGHT HOLDERS BE LIABLE FOR ANY CLAIM, DAMAGES OR OTHER LIABILITY, WHETHER IN AN ACTION OF CONTRACT, TORT OR OTHERWISE, ARISING FROM, OUT OF OR IN CONNECTION WITH THE SOFTWARE OR THE USE OR OTHER DEALINGS IN THE SOFTWARE.

-
- Module: libgcrypt

Additional license notices for Libgcrypt. *- org -*

This file contains the copying permission notices for various files in the Libgcrypt distribution which are not covered by the GNU Lesser General Public License (LGPL) or the GNU General Public License (GPL).

These notices all require that a copy of the notice be included in the accompanying documentation and be distributed with binary distributions of the code, so be derived to include this file along with any binary distributions from the GNU C Library.

* BSD_3Clause

For files:
- cipher/sha256-avx-amd64.S
- cipher/sha256-avx2-bmi2-amd64.S
- cipher/sha256-ssse3-amd64.S
- cipher/sha512-avx-amd64.S
- cipher/sha512-avx2-bmi2-amd64.S
- cipher/sha512-ssse3-amd64.S

##+begin_quote
Copyright (c) 2012, Intel Corporation

All rights reserved.

Redistribution and use in source and binary forms, with or without modification, are permitted provided that the following conditions are met:

* Redistributions of source code must retain the above copyright notice, this list of conditions and the following disclaimer.

* Redistributions in binary form must reproduce the above copyright notice, this list of conditions and the following disclaimer in the documentation and/or other materials provided with the distribution.

* Neither the name of the Intel Corporation nor the names of its contributors may be used to endorse or promote products derived from this software without specific prior written permission.

THIS SOFTWARE IS PROVIDED BY INTEL CORPORATION "AS IS" AND ANY EXPRESS OR IMPLIED WARRANTIES, INCLUDING, BUT NOT LIMITED TO, THE IMPLIED WARRANTIES OF MERCHANTABILITY AND FITNESS FOR A PARTICULAR PURPOSE ARE DISCLAIMED. IN NO EVENT SHALL INTEL CORPORATION OR CONTRIBUTORS BE LIABLE FOR ANY DIRECT, INDIRECT, INCIDENTAL, SPECIAL, EXEMPLARY, OR CONSEQUENTIAL DAMAGES (INCLUDING, BUT NOT LIMITED TO, PROCUREMENT OF SUBSTITUTE GOODS OR SERVICES; LOSS OF USE, DATA, OR PROFITS; OR BUSINESS INTERRUPTION) HOWEVER CAUSED AND ON ANY THEORY OF LIABILITY, WHETHER IN CONTRACT, STRICT LIABILITY, OR TORT (INCLUDING NEGLIGENCE OR OTHERWISE) ARISING IN ANY WAY OUT OF THE USE OF THIS SOFTWARE, EVEN IF ADVISED OF THE POSSIBILITY OF SUCH DAMAGE.

##+end_quote

* X License
For files:
- install.sh

##+begin_quote

Copyright (C) 1994 X Consortium

Permission is hereby granted, free of charge, to any person obtaining a copy of this software and associated documentation files (the "Software"), to deal in the Software without restriction, including without limitation the rights to use, copy, modify, merge, publish, distribute, sublicense, and/or sell copies of the Software, and to permit persons to whom the Software is furnished to do so, subject to the following conditions:

The above copyright notice and this permission notice shall be included in all copies or substantial portions of the Software.

THE SOFTWARE IS PROVIDED "AS IS", WITHOUT WARRANTY OF ANY KIND, EXPRESS OR IMPLIED, INCLUDING BUT NOT LIMITED TO THE WARRANTIES OF MERCHANTABILITY, FITNESS FOR A PARTICULAR PURPOSE AND NONINFRINGEMENT. IN NO EVENT SHALL THE X CONSORTIUM BE LIABLE FOR ANY CLAIM, DAMAGES OR OTHER LIABILITY, WHETHER IN AN ACTION OF CONTRACT, TORT OR OTHERWISE, ARISING FROM, OUT OF OR IN CONNECTION WITH THE SOFTWARE OR THE USE OR OTHER DEALINGS IN THE SOFTWARE.

Except as contained in this notice, the name of the X Consortium shall not be used in advertising or otherwise to promote the sale, use or other dealings in this Software without prior written authorization from the X Consortium.

##+end_quote

* Public domain

For files:
- cipher/arcfour-amd64.S

##+begin_quote
Author: Marc Bevand <bevand_m (at) epita.fr>
Licence: I hereby disclaim the copyright on this code and place it in the public domain.
##+end_quote

* OCB license 1

For files:
- cipher/cipher-ocb.c

##+begin_quote
OCB is covered by several patents but may be used freely by most software. See <http://web.cs.ucdavis.edu/~rogaway/ocb/license.htm>. In particular license 1 is suitable for Libgcrypt: See <http://web.cs.ucdavis.edu/~rogaway/ocb/license1.pdf> for the full license document; it basically says:

License 1 — License for Open-Source Software Implementations of OCB (Jan 9, 2013)

Under this license, you are authorized to make, use, and distribute open-source software implementations of OCB. This license terminates for you if you sue someone over their open-source software implementation of OCB claiming that you have a patent covering their implementation.

License for Open Source Software Implementations of OCB
January 9, 2013

1 Definitions

1.1 "Licensor" means Phillip Rogaway.

1.2 "Licensed Patents" means any patent that claims priority to United States Patent Application No. 09/918,615 entitled "Method and Apparatus for Facilitating Efficient Authenticated Encryption," and any utility, divisional, provisional, continuation, continuations-in-part, reexamination, reissue, or foreign counterpart patents that may issue with respect to the aforesaid patent application. This includes, but is not limited to, United States Patent No. 7,046,802; United States Patent No. 7,200,227; United States Patent No. 7,949,129; United States Patent No. 8,321,675 ; and any patent that issues out of United States Patent Application No. 13/669,114.

1.3 "Use" means any practice of any invention claimed in the Licensed Patents.

1.4 "Software Implementation" means any practice of any invention claimed in the Licensed Patents that takes the form of software executing on a user-programmable, general-purpose computer or that takes the form of a computer-readable medium storing such software. Software Implementation does not include, for example, application-specific integrated circuits (ASICs), field-programmable gate arrays (FPGAs), embedded systems, or IP cores.

1.5 "Open Source Software" means software whose source code is published and made available for inspection and use by anyone because either (a) the source code is subject to a license that permits recipients to copy, modify, and distribute the source code without payment of fees or royalties, or (b) the source code is in the public domain, including code released for public use through a CC0 waiver. All licenses certified by the Open Source Initiative at opensource.org as of January 9, 2013 and all Creative Commons licenses identified on the creativecommons.org website as of January 9, 2013, including the Public License Fallback of the CC0 waiver, satisfy these requirements for the purposes of this license.

1.6 "Open Source Software Implementation" means a Software Implementation in which the software implicating the Licensed Patents is Open Source Software. Open Source Software Implementation does not include any Software Implementation in which the software implicating the Licensed Patents is combined, so as to form a larger program, with software that is not Open Source Software.

2 License Grant

2.1 License. Subject to your compliance with the terms of this license, including the restriction set forth in Section 2.2, Licensor hereby grants to you a perpetual, worldwide, non-exclusive, non-transferable, non-sublicenseable, no-charge, royalty-free, irrevocable license to practice any invention claimed in the Licensed Patents in any Open Source Software Implementation.

2.2 Restriction. If you or your affiliates institute patent litigation (including, but not limited to, a cross-claim or counterclaim in a lawsuit) against any entity alleging that any Use authorized by this license infringes another patent, then any rights granted to you under this license automatically terminate as of the date such litigation is filed.

3 Disclaimer

YOUR USE OF THE LICENSED PATENTS IS AT YOUR OWN RISK AND UNLESS REQUIRED BY APPLICABLE LAW, LICENSOR MAKES NO REPRESENTATIONS OR WARRANTIES OF ANY KIND CONCERNING THE LICENSED PATENTS OR ANY PRODUCT EMBODYING ANY LICENSED PATENT, EXPRESS OR IMPLIED, STATUTORY OR OTHERWISE, INCLUDING, WITHOUT LIMITATION, DIRECT, INDIRECT, INCIDENTAL, CONSEQUENTIAL, PUNITIVE OR SPECIAL DAMAGES, EVEN IF LICENSOR HAS BEEN ADVISED OF THE POSSIBILITY OF SUCH DAMAGES PRIOR TO SUCH AN OCCURRENCE.

##+end_quote

- Module: jansson

Copyright (c) 2009-2014 Petri Lehtinen <petri@digip.org>

Permission is hereby granted, free of charge, to any person obtaining a copy of this software and associated documentation files (the "Software"), to deal in the Software without restriction, including without limitation the rights to use, copy, modify, merge, publish, distribute, sublicense, and/or sell copies of the Software, and to permit persons to whom the Software is furnished to do so, subject to the following conditions:

The above copyright notice and this permission notice shall be included in all copies or substantial portions of the Software.

THE SOFTWARE IS PROVIDED "AS IS", WITHOUT WARRANTY OF ANY KIND, EXPRESS OR IMPLIED, INCLUDING BUT NOT LIMITED TO THE WARRANTIES OF MERCHANTABILITY, FITNESS FOR A PARTICULAR PURPOSE AND NONINFRINGEMENT. IN NO EVENT SHALL

THE AUTHORS OR COPYRIGHT HOLDERS BE LIABLE FOR ANY CLAIM, DAMAGES OR OTHER LIABILITY, WHETHER IN AN ACTION OF CONTRACT, TORT OR OTHERWISE, ARISING FROM, OUT OF OR IN CONNECTION WITH THE SOFTWARE OR THE USE OR OTHER DEALINGS IN THE SOFTWARE.

- Module: libcurl

COPYRIGHT AND PERMISSION NOTICE

Copyright (c) 1996 - 2016, Daniel Stenberg, <daniel@haxx.se>, and many contributors, see the THANKS file.

All rights reserved.

Permission to use, copy, modify, and distribute this software for any purpose with or without fee is hereby granted, provided that the above copyright notice and this permission notice appear in all copies.

THE SOFTWARE IS PROVIDED "AS IS", WITHOUT WARRANTY OF ANY KIND, EXPRESS OR IMPLIED, INCLUDING BUT NOT LIMITED TO THE WARRANTIES OF MERCHANTABILITY, FITNESS FOR A PARTICULAR PURPOSE AND NONINFRINGEMENT OF THIRD PARTY RIGHTS. IN NO EVENT SHALL THE AUTHORS OR COPYRIGHT HOLDERS BE LIABLE FOR ANY CLAIM, DAMAGES OR OTHER LIABILITY, WHETHER IN AN ACTION OF CONTRACT, TORT OR OTHERWISE, ARISING FROM, OUT OF OR IN CONNECTION WITH THE SOFTWARE OR THE USE OR OTHER DEALINGS IN THE SOFTWARE.

Except as contained in this notice, the name of a copyright holder shall not be used in advertising or otherwise to promote the sale, use or other dealings in this Software without prior written authorization of the copyright holder.

- Module: openssl

The licences which components of this software fall under are as follows. First, we will summarize and say that all components are under a BSD licence, or a licence more free than that.

OpenSSH contains no GPL code.

- 1) * Copyright (c) 1995 Tatu Ylonen <ylo@cs.hut.fi>, Espoo, Finland
* All rights reserved
* As far as I am concerned, the code I have written for this software
* can be used freely for any purpose. Any derived versions of this
* software must be clearly marked as such, and if the derived work is
* incompatible with the protocol description in the RFC file, it must be
* called by a name other than "ssh" or "Secure Shell".

[Tatu continues]

- * However, I am not implying to give any licenses to any patents or
- * copyrights held by third parties, and the software includes parts that
- * are not under my direct control. As far as I know, all included
- * source code is used in accordance with the relevant license agreements
- * and can be used freely for any purpose (the GNU license being the most
- * restrictive); see below for details.

[However, none of that term is relevant at this point in time. All of these restrictively licenced software components which he talks about have been removed from OpenSSH, i.e.,

- RSA is no longer included, found in the OpenSSL library
- IDEA is no longer included, its use is deprecated
- DES is now external, in the OpenSSL library
- GMP is no longer used, and instead we call BN code from OpenSSL
- Zlib is now external, in a library
- The make-ssh-known-hosts script is no longer included
- TSS has been removed

- MD5 is now external, in the OpenSSL library
- RC4 support has been replaced with ARC4 support from OpenSSL
- Blowfish is now external, in the OpenSSL library

Note that any information and cryptographic algorithms used in this software are publicly available on the Internet and at any major bookstore, scientific library, and patent office worldwide. More information can be found e.g. at "<http://www.cs.hut.fi/crypto>".

The legal status of this program is some combination of all these permissions and restrictions. Use only at your own responsibility. You will be responsible for any legal consequences yourself; I am not making any claims whether possessing or using this is legal or not in your country, and I am not taking any responsibility on your behalf.

NO WARRANTY

BECAUSE THE PROGRAM IS LICENSED FREE OF CHARGE, THERE IS NO WARRANTY FOR THE PROGRAM, TO THE EXTENT PERMITTED BY APPLICABLE LAW. EXCEPT WHEN OTHERWISE STATED IN WRITING THE COPYRIGHT HOLDERS AND/OR OTHER PARTIES PROVIDE THE PROGRAM "AS IS" WITHOUT WARRANTY OF ANY KIND, EITHER EXPRESSED OR IMPLIED, INCLUDING, BUT NOT LIMITED TO, THE IMPLIED WARRANTIES OF MERCHANTABILITY AND FITNESS FOR A PARTICULAR PURPOSE. THE ENTIRE RISK AS TO THE QUALITY AND PERFORMANCE OF THE PROGRAM IS WITH YOU. SHOULD THE PROGRAM PROVE DEFECTIVE, YOU ASSUME THE COST OF ALL NECESSARY SERVICING, REPAIR OR CORRECTION.

IN NO EVENT UNLESS REQUIRED BY APPLICABLE LAW OR AGREED TO IN WRITING WILL ANY COPYRIGHT HOLDER, OR ANY OTHER PARTY WHO MAY MODIFY AND/OR REDISTRIBUTE THE PROGRAM AS PERMITTED ABOVE, BE LIABLE TO YOU FOR DAMAGES, INCLUDING ANY GENERAL, SPECIAL, INCIDENTAL OR CONSEQUENTIAL DAMAGES ARISING OUT OF THE USE OR INABILITY TO USE THE PROGRAM (INCLUDING BUT NOT LIMITED TO LOSS OF DATA OR DATA BEING RENDERED INACCURATE OR LOSSES SUSTAINED BY YOU OR THIRD PARTIES OR A FAILURE OF THE PROGRAM TO OPERATE WITH ANY OTHER PROGRAMS), EVEN IF SUCH HOLDER OR OTHER PARTY HAS BEEN ADVISED OF THE POSSIBILITY OF SUCH DAMAGES.

- 2) The 32-bit CRC compensation attack detector in deattack.c was contributed by CORE SDI S.A. under a BSD-style license.

* Cryptographic attack detector for ssh - source code

* Copyright (c) 1998 CORE SDI S.A., Buenos Aires, Argentina.

* All rights reserved. Redistribution and use in source and binary forms, with or without modification, are permitted provided that this copyright notice is retained.

* THIS SOFTWARE IS PROVIDED "AS IS" AND ANY EXPRESS OR IMPLIED WARRANTIES ARE DISCLAIMED. IN NO EVENT SHALL CORE SDI S.A. BE LIABLE FOR ANY DIRECT, INDIRECT, INCIDENTAL, SPECIAL, EXEMPLARY OR CONSEQUENTIAL DAMAGES RESULTING FROM THE USE OR MISUSE OF THIS SOFTWARE.

* Ariel Futoransky <futo@core-sdi.com>
* <<http://www.core-sdi.com>>

- 3) ssh-keyscan was contributed by David Mazieres under a BSD-style license.

* Copyright 1995, 1996 by David Mazieres <dm@lcs.mit.edu>.

* Modification and redistribution in source and binary forms is permitted provided that due credit is given to the author and the OpenBSD project by leaving this copyright notice intact.

- 4) The Rijndael implementation by Vincent Rijmen, Antoon Bosselaers and Paulo Barreto is in the public domain and distributed with the following license:

* @version 3.0 (December 2000)

* Optimised ANSI C code for the Rijndael cipher (now AES)

* @author Vincent Rijmen <vincent.rijmen@esat.kuleuven.ac.be>
* @author Antoon Bosselaers <antoon.bosselaers@esat.kuleuven.ac.be>
* @author Paulo Barreto <paulo.barreto@terra.com.br>

* This code is hereby placed in the public domain.

* THIS SOFTWARE IS PROVIDED BY THE AUTHORS "AS IS" AND ANY EXPRESS OR IMPLIED WARRANTIES, INCLUDING, BUT NOT LIMITED TO, THE IMPLIED WARRANTIES OF MERCHANTABILITY AND FITNESS FOR A PARTICULAR PURPOSE ARE DISCLAIMED. IN NO EVENT SHALL THE AUTHORS OR CONTRIBUTORS BE LIABLE FOR ANY DIRECT, INDIRECT, INCIDENTAL, SPECIAL, EXEMPLARY, OR CONSEQUENTIAL DAMAGES (INCLUDING, BUT NOT LIMITED TO, PROCUREMENT

OF SUBSTITUTE GOODS OR SERVICES; LOSS OF USE, DATA, OR PROFITS; OR BUSINESS INTERRUPTION) HOWEVER CAUSED AND ON ANY THEORY OF LIABILITY, WHETHER IN CONTRACT, STRICT LIABILITY, OR TORT (INCLUDING NEGLIGENCE OR OTHERWISE) ARISING IN ANY WAY OUT OF THE USE OF THIS SOFTWARE, EVEN IF ADVISED OF THE POSSIBILITY OF SUCH DAMAGE.

- 5) One component of the ssh source code is under a 3-clause BSD license, held by the University of California, since we pulled these parts from original Berkeley code.

* Copyright (c) 1983, 1990, 1992, 1993, 1995
* The Regents of the University of California. All rights reserved.

* Redistribution and use in source and binary forms, with or without modification, are permitted provided that the following conditions are met:

- * 1. Redistributions of source code must retain the above copyright notice, this list of conditions and the following disclaimer.
- * 2. Redistributions in binary form must reproduce the above copyright notice, this list of conditions and the following disclaimer in the documentation and/or other materials provided with the distribution.
- * 3. Neither the name of the University nor the names of its contributors may be used to endorse or promote products derived from this software without specific prior written permission.

* THIS SOFTWARE IS PROVIDED BY THE REGENTS AND CONTRIBUTORS "AS IS" AND ANY EXPRESS OR IMPLIED WARRANTIES, INCLUDING, BUT NOT LIMITED TO, THE IMPLIED WARRANTIES OF MERCHANTABILITY AND FITNESS FOR A PARTICULAR PURPOSE

* ARE DISCLAIMED. IN NO EVENT SHALL THE REGENTS OR CONTRIBUTORS BE LIABLE

* FOR ANY DIRECT, INDIRECT, INCIDENTAL, SPECIAL, EXEMPLARY, OR CONSEQUENTIAL DAMAGES (INCLUDING, BUT NOT LIMITED TO, PROCUREMENT OF SUBSTITUTE GOODS

* OR SERVICES; LOSS OF USE, DATA, OR PROFITS; OR BUSINESS INTERRUPTION) HOWEVER CAUSED AND ON ANY THEORY OF LIABILITY, WHETHER IN CONTRACT, STRICT

* LIABILITY, OR TORT (INCLUDING NEGLIGENCE OR OTHERWISE) ARISING IN ANY

* WAY OUT OF THE USE OF THIS SOFTWARE, EVEN IF ADVISED OF THE POSSIBILITY OF SUCH DAMAGE.

- 6) Remaining components of the software are provided under a standard 2-term BSD licence with the following names as copyright holders:

Markus Friedl
Theo de Raadt
Niels Provos
Dug Song
Aaron Campbell
Damien Miller
Kevin Steves
Daniel Kouril
Wesley Griffin
Per Allansson

Nils Nordman
Simon Wilkinson

Portable OpenSSH additionally includes code from the following copyright holders, also under the 2-term BSD license:

Ben Lindstrom
Tim Rice
Andre Lucas
Chris Adams
Corinna Vinschen
Cray Inc.
Denis Parker
Gert Doering
Jakob Schlyter
Jason Downs
Juha Yrjölä
Michael Stone
Networks Associates Technology, Inc.
Solar Designer
Todd C. Miller
Wayne Schroeder
William Jones
Darren Tucker
Sun Microsystems
The SCO Group
Daniel Walsh
Red Hat, Inc
Simon Vallet / Genoscope

* Redistribution and use in source and binary forms, with or without
* modification, are permitted provided that the following conditions
* are met:
* 1. Redistributions of source code must retain the above copyright
* notice, this list of conditions and the following disclaimer.
* 2. Redistributions in binary form must reproduce the above copyright
* notice, this list of conditions and the following disclaimer in the
* documentation and/or other materials provided with the distribution.
*
* THIS SOFTWARE IS PROVIDED BY THE AUTHOR "AS IS" AND ANY EXPRESS OR
* IMPLIED WARRANTIES, INCLUDING, BUT NOT LIMITED TO, THE IMPLIED

WARRANTIES
* OF MERCHANTABILITY AND FITNESS FOR A PARTICULAR PURPOSE ARE
DISCLAIMED.
* IN NO EVENT SHALL THE AUTHOR BE LIABLE FOR ANY DIRECT, INDIRECT,
BUT
* INCIDENTAL, SPECIAL, EXEMPLARY, OR CONSEQUENTIAL DAMAGES (INCLUDING,
USE,
* NOT LIMITED TO, PROCUREMENT OF SUBSTITUTE GOODS OR SERVICES; LOSS OF
ANY
* DATA, OR PROFITS; OR BUSINESS INTERRUPTION) HOWEVER CAUSED AND ON
OF
* THEORY OF LIABILITY, WHETHER IN CONTRACT, STRICT LIABILITY, OR TORT
* (INCLUDING NEGLIGENCE OR OTHERWISE) ARISING IN ANY WAY OUT OF THE USE
OF
* THIS SOFTWARE, EVEN IF ADVISED OF THE POSSIBILITY OF SUCH DAMAGE.

8) Portable OpenSSH contains the following additional licenses:

a) md5crypt.c, md5crypt.h

* "THE BEER-WARE LICENSE" (Revision 42):
* <phk@login.dknet.dk> wrote this file. As long as you retain this
* notice you can do whatever you want with this stuff. If we meet
* some day, and you think this stuff is worth it, you can buy me a
* beer in return. Poul-Henning Kamp

b) snprintf replacement

* Copyright Patrick Powell 1995
* This code is based on code written by Patrick Powell
* (papowell@astart.com) It may be used for any purpose as long as this
* notice remains intact on all source code distributions

c) Compatibility code (openshd-compat)

Apart from the previously mentioned licenses, various pieces of code in the openshd-compat/ subdirectory are licensed as follows:

Some code is licensed under a 3-term BSD license, to the following copyright holders:

Todd C. Miller
Theo de Raadt
Damien Miller
Eric P. Allman
The Regents of the University of California
Constantin S. Svintsoff

* Redistribution and use in source and binary forms, with or without
* modification, are permitted provided that the following conditions
* are met:
* 1. Redistributions of source code must retain the above copyright
* notice, this list of conditions and the following disclaimer.
* 2. Redistributions in binary form must reproduce the above copyright
* notice, this list of conditions and the following disclaimer in the
* documentation and/or other materials provided with the distribution.
* 3. Neither the name of the University nor the names of its contributors
* may be used to endorse or promote products derived from this software
* without specific prior written permission.
*

* THIS SOFTWARE IS PROVIDED BY THE REGENTS AND CONTRIBUTORS "AS IS" AND
* ANY EXPRESS OR IMPLIED WARRANTIES, INCLUDING, BUT NOT LIMITED TO, THE
* IMPLIED WARRANTIES OF MERCHANTABILITY AND FITNESS FOR A PARTICULAR
PURPOSE
* ARE DISCLAIMED. IN NO EVENT SHALL THE REGENTS OR CONTRIBUTORS BE LIABLE
* FOR ANY DIRECT, INDIRECT, INCIDENTAL, SPECIAL, EXEMPLARY, OR CONSEQUENTIAL
* DAMAGES (INCLUDING, BUT NOT LIMITED TO, PROCUREMENT OF SUBSTITUTE
GOODS
* OR SERVICES; LOSS OF USE, DATA, OR PROFITS; OR BUSINESS INTERRUPTION)
* HOWEVER CAUSED AND ON ANY THEORY OF LIABILITY, WHETHER IN CONTRACT,
* STRICT LIABILITY, OR TORT (INCLUDING NEGLIGENCE OR OTHERWISE) ARISING IN
ANY
* WAY OUT OF THE USE OF THIS SOFTWARE, EVEN IF ADVISED OF THE POSSIBILITY OF
* SUCH DAMAGE.

Some code is licensed under an ISC-style license, to the following copyright holders:

Internet Software Consortium.
Todd C. Miller
Reyk Floeter
Chad Mynhier

* Permission to use, copy, modify, and distribute this software for any
* purpose with or without fee is hereby granted, provided that the above
* copyright notice and this permission notice appear in all copies.
*
* THE SOFTWARE IS PROVIDED "AS IS" AND TODD C. MILLER DISCLAIMS ALL
* WARRANTIES WITH REGARD TO THIS SOFTWARE INCLUDING ALL IMPLIED WARRANTIES
* OF MERCHANTABILITY AND FITNESS. IN NO EVENT SHALL TODD C. MILLER BE LIABLE
* FOR ANY SPECIAL, DIRECT, INDIRECT, OR CONSEQUENTIAL DAMAGES OR ANY
DAMAGES
* WHATSOEVER RESULTING FROM LOSS OF USE, DATA OR PROFITS, WHETHER IN AN
ACTION
* OF CONTRACT, NEGLIGENCE OR OTHER TORTIOUS ACTION, ARISING OUT OF OR IN
* CONNECTION WITH THE USE OR PERFORMANCE OF THIS SOFTWARE.

Some code is licensed under a MIT-style license to the following copyright holders:

Free Software Foundation, Inc.

* Permission is hereby granted, free of charge, to any person obtaining a *
* copy of this software and associated documentation files (the *
* "Software"), to deal in the Software without restriction, including *
* without limitation the rights to use, copy, modify, merge, publish, *
* distribute, distribute with modifications, sublicense, and/or sell *
* copies of the Software, and to permit persons to whom the Software is *
* furnished to do so, subject to the following conditions: *
*

* The above copyright notice and this permission notice shall be included *
* in all copies or substantial portions of the Software. *

* THE SOFTWARE IS PROVIDED "AS IS", WITHOUT WARRANTY OF ANY KIND, EXPRESS *
* OR IMPLIED, INCLUDING BUT NOT LIMITED TO THE WARRANTIES OF *
* MERCHANTABILITY, FITNESS FOR A PARTICULAR PURPOSE AND NONINFRINGEMENT. *

* IN NO EVENT SHALL THE ABOVE COPYRIGHT HOLDERS BE LIABLE FOR ANY CLAIM, *
* DAMAGES OR OTHER LIABILITY, WHETHER IN AN ACTION OF CONTRACT, TORT OR *

* OTHERWISE, ARISING FROM, OUT OF OR IN CONNECTION WITH THE SOFTWARE OR *

* THE USE OR OTHER DEALINGS IN THE SOFTWARE. *

* Except as contained in this notice, the name(s) of the above copyright *
* holders shall not be used in advertising or otherwise to promote the *
* sale, use or other dealings in this Software without prior written *
* authorization. *

- Module: freesd-libc

@(#)COPYRIGHT 8.2 (Berkeley) 3/21/94

All of the documentation and software included in the 4.4BSD and 4.4BSD-Lite
Releases is copyrighted by The Regents of the University of California.

Copyright 1979, 1980, 1983, 1986, 1988, 1989, 1991, 1992, 1993, 1994
The Regents of the University of California. All rights reserved.

Redistribution and use in source and binary forms, with or without
modification, are permitted provided that the following conditions
are met:

1. Redistributions of source code must retain the above copyright
notice, this list of conditions and the following disclaimer.
2. Redistributions in binary form must reproduce the above copyright
notice, this list of conditions and the following disclaimer in the
documentation and/or other materials provided with the distribution.
3. All advertising materials mentioning features or use of this software
must display the following acknowledgement:

This product includes software developed by the University of
California, Berkeley and its contributors.

4. Neither the name of the University nor the names of its contributors
may be used to endorse or promote products derived from this software
without specific prior written permission.

THIS SOFTWARE IS PROVIDED BY THE REGENTS AND CONTRIBUTORS "AS IS" AND
ANY EXPRESS OR IMPLIED WARRANTIES, INCLUDING, BUT NOT LIMITED TO, THE
IMPLIED WARRANTIES OF MERCHANTABILITY AND FITNESS FOR A PARTICULAR
PURPOSE
ARE DISCLAIMED. IN NO EVENT SHALL THE REGENTS OR CONTRIBUTORS BE LIABLE
FOR ANY DIRECT, INDIRECT, INCIDENTAL, SPECIAL, EXEMPLARY, OR CONSEQUENTIAL
DAMAGES (INCLUDING, BUT NOT LIMITED TO, PROCUREMENT OF SUBSTITUTE GOODS
OR SERVICES; LOSS OF USE, DATA, OR PROFITS; OR BUSINESS INTERRUPTION)
HOWEVER CAUSED AND ON ANY THEORY OF LIABILITY, WHETHER IN CONTRACT,
STRICT LIABILITY, OR TORT (INCLUDING NEGLIGENCE OR OTHERWISE) ARISING IN ANY
WAY OUT OF THE USE OF THIS SOFTWARE, EVEN IF ADVISED OF THE POSSIBILITY OF
SUCH DAMAGE.

The Institute of Electrical and Electronics Engineers and the American
National Standards Committee X3, on Information Processing Systems have
given us permission to reprint portions of their documentation.

In the following statement, the phrase "this text" refers to portions
of the system documentation.

Portions of this text are reprinted and reproduced in electronic form in
the second BSD Networking Software Release, from IEEE Std 1003.1-1988, IEEE
Standard Portable Operating System Interface for Computer Environments
(POSIX), copyright C 1988 by the Institute of Electrical and Electronics
Engineers, Inc. In the event of any discrepancy between these versions

and the original IEEE Standard, the original IEEE Standard is the referee document.

In the following statement, the phrase "This material" refers to portions of the system documentation.

This material is reproduced with permission from American National Standards Committee X3, on Information Processing Systems. Computer and Business Equipment Manufacturers Association (CBEMA), 311 First St., NW, Suite 500, Washington, DC 20001-2178. The developmental work of Programming Language C was completed by the X3J11 Technical Committee.

The views and conclusions contained in the software and documentation are those of the authors and should not be interpreted as representing official policies, either expressed or implied, of the Regents of the University of California.

-
- Module: strace

Copyright (c) 1991, 1992 Paul Kranenburg <pk@cs.few.eur.nl>
Copyright (c) 1993 Branko Lankester <branko@hacktic.nl>
Copyright (c) 1993 Ulrich Pegelow <pegelow@moorea.uni-muenster.de>
Copyright (c) 1995, 1996 Michael Elizabeth Chastain <mec@duracef.shout.net>
Copyright (c) 1993, 1994, 1995, 1996 Rick Sladkey <rsj@world.std.com>
Copyright (C) 1998-2001 Wichert Akkerman <wakkerma@deephackmode.org>
Copyright (C) 2001-2017 The strace developers.
All rights reserved.

Redistribution and use in source and binary forms, with or without modification, are permitted provided that the following conditions are met:

1. Redistributions of source code must retain the above copyright notice, this list of conditions and the following disclaimer.
2. Redistributions in binary form must reproduce the above copyright notice, this list of conditions and the following disclaimer in the documentation and/or other materials provided with the distribution.
3. The name of the author may not be used to endorse or promote products derived from this software without specific prior written permission.

THIS SOFTWARE IS PROVIDED BY THE AUTHOR "AS IS" AND ANY EXPRESS OR IMPLIED WARRANTIES, INCLUDING, BUT NOT LIMITED TO, THE IMPLIED WARRANTIES OF MERCHANTABILITY AND FITNESS FOR A PARTICULAR PURPOSE ARE DISCLAIMED. IN NO EVENT SHALL THE AUTHOR BE LIABLE FOR ANY DIRECT, INDIRECT, INCIDENTAL, SPECIAL, EXEMPLARY, OR CONSEQUENTIAL DAMAGES (INCLUDING, BUT NOT LIMITED TO, PROCUREMENT OF SUBSTITUTE GOODS OR SERVICES; LOSS OF USE, DATA, OR PROFITS; OR BUSINESS INTERRUPTION) HOWEVER CAUSED AND ON ANY THEORY OF LIABILITY, WHETHER IN CONTRACT, STRICT LIABILITY, OR TORT (INCLUDING NEGLIGENCE OR OTHERWISE) ARISING IN ANY WAY OUT OF THE USE OF THIS SOFTWARE, EVEN IF ADVISED OF THE POSSIBILITY OF SUCH DAMAGE.

-
- Module: libpcap

Copyright (C) 1993-2008 The Regents of the University of California.

Redistribution and use in source and binary forms, with or without modification, are permitted provided that the following conditions are met:

1. Redistributions of source code must retain the above copyright notice, this list of conditions and the following disclaimer.
2. Redistributions in binary form must reproduce the above copyright notice, this list of conditions and the following disclaimer in the documentation and/or other materials provided with the distribution.
3. The names of the authors may not be used to endorse or promote products derived from this software without specific prior written permission.

THIS SOFTWARE IS PROVIDED "AS IS" AND WITHOUT ANY EXPRESS OR IMPLIED WARRANTIES, INCLUDING, WITHOUT LIMITATION, THE IMPLIED WARRANTIES OF MERCHANTABILITY AND FITNESS FOR A PARTICULAR PURPOSE.

-
- Module: tcpdump

Licensed under the 3-clause BSD license:

Redistribution and use in source and binary forms, with or without modification, are permitted provided that the following conditions are met:

1. Redistributions of source code must retain the above copyright notice, this list of conditions and the following disclaimer.
2. Redistributions in binary form must reproduce the above copyright notice, this list of conditions and the following disclaimer in the documentation and/or other materials provided with the distribution.
3. The names of the authors may not be used to endorse or promote products derived from this software without specific prior written permission.

THIS SOFTWARE IS PROVIDED "AS IS" AND WITHOUT ANY EXPRESS OR IMPLIED WARRANTIES, INCLUDING, WITHOUT LIMITATION, THE IMPLIED WARRANTIES OF MERCHANTABILITY AND FITNESS FOR A PARTICULAR PURPOSE.

Some files in this package are licensed under the 4-clause BSD license, the copyright on most of them belongs to The Regents of the University of California. Since the license was retroactively changed in 1999 to remove the advertising clause, they are effectively under the 3-clause license even if the text of the license in the files hasn't been updated. See the following document for more details:

<ftp://ftp.cs.berkeley.edu/pub/4bsd/README.Imp.License.Change>>

Other files under the 4-clause BSD license and whose copyright doesn't belong to The Regents of the University of California are listed below:

- aodv.h, Copyright (c) 2003 Bruce M. Simpson
- atmuni311.h, Copyright (c) 1997 Yen Yen Lim and North Dakota State University
- ieee802_11.h, Copyright (c) 2001 Fortress Technologies and Charlie Lenahan
- print-802_11.c, Copyright (c) 2001 Fortress Technologies and Charlie Lenahan
- print-aodv.c, Copyright (c) 2003 Bruce M. Simpson
- print-ascii.c, Copyright (c) 1997, 1998 The NetBSD Foundation, Inc.
- print-cnfp.c, Copyright (c) 1998 Michael Shalayeff
- print-gre.c, Copyright (c) 2002 Jason L. Wright
- print-mobile.c, Copyright (c) 1998 The NetBSD Foundation, Inc.
- print-sunatm.c, Copyright (c) 1997 Yen Yen Lim and North Dakota State University
- print-telnet.c, Copyright (c) 1997, 1998 The NetBSD Foundation, Inc.
- print-timed.c, Copyright (c) 2000 Ben Smithurst
- missing/inet_aton.c, Copyright (c) 1995, 1996, 1997 Kungliga Tekniska Högskolan (Royal Institute of Technology, Stockholm, Sweden).
- missing/inet_ntop.c, Copyright (c) 1995, 1996, 1997 Kungliga Tekniska Högskolan (Royal Institute of Technology, Stockholm, Sweden).
- missing/inet_pton.c, Copyright (c) 1995, 1996, 1997 Kungliga Tekniska Högskolan (Royal Institute of Technology, Stockholm, Sweden).

-
- Module: ssmppg

Copyright (C) 2005, 2006 Stig Venaas <venaas@uninett.no>

Permission to use, copy, modify, and distribute this software for any purpose with or without fee is hereby granted, provided that the above copyright notice and this permission notice appear in all copies.

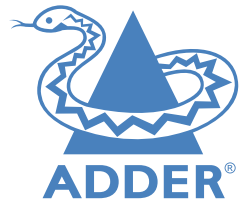

www.adder.com

- A**
 - Adapters
 - video 9
 - Admin menus 21
 - Advanced page
 - receiver 24
 - transmitter 29
 - API 38
 - Audio connections 12
- C**
 - Cable types 37
 - Category rating 37
 - Channel List 17
 - Channels
 - switching 31
 - Configuration wizard 14
 - Connections
 - audio 12
 - computer 8
 - console 11
 - link 12
 - overview 7
 - power 13
 - Crosstalk 37
- D**
 - Disconnect
 - from channel 31
 - DisplayPort 9
 - DVI 9
 - Dynamic IP address 24
- E**
 - Enable Remote Control 24
- F**
 - Fast-Leave
 - IGMP 35
 - File systems
 - supported 26
 - FTP 37
- G**
 - General Settings page
 - receiver 21
 - transmitter 27
- H**
 - Hotkeys 22
 - channel switching 31
 - configuring 32
- I**
 - IGMP 35
 - Indicators 33
 - Interference
 - protection 37
 - Internet Group Management Protocol 35
- K**
 - Keyboard navigation 14
- L**
 - Link connection 12
 - LNK
 - indicator 33
- M**
 - Manage Ports page
 - receiver 23
 - transmitter 28
 - Matrix 3
 - Menu
 - admin 21
 - Mounting 7
- N**
 - Navigation
 - of menus 14
 - Network switch
 - specifications 12
 - Node
 - restore 20
- O**
 - Optional extras 6
 - OSD Mouse Launch 22
 - OSD Settings page 22
 - OSD Timeout 22
- P**
 - PiMF 37
 - PoE 12
 - Power connection 13
 - Power over Ethernet 12
 - Public REST API 38
 - PWR
 - indicator 33

- R**
 - Rack mount bracket 7
 - Recovery mode 33
 - Remote Control 24
 - Remote Logging Address 25,29
 - Remote Support 25,29
 - Reset 20
 - Reset button 4
 - REST API 3,38
 - Restore node 20
- S**
 - Screening 37
 - Setup Channels page 27
 - Severity Level 25,29
 - Shielding 37
 - Snooping
 - IGMP 35
 - Software Upgrade page
 - receiver 26
 - transmitter 30
 - SoL 16
 - Start of Life 16
 - Static IP address 24
 - STP 37
 - Supplied items 5
 - Supported file systems 26
 - Switching channels 31
- T**
 - Transmitter node
 - add 18
- U**
 - USB
 - indicator 33
 - UTP 37
- V**
 - VID
 - indicator 33
 - Video format
 - conversion 9,10
 - Video resolutions
 - maximum 8
- W**
 - Wizard
 - configuration 14
- Y**
 - YAML 38