



Control Your Video

VIDEO WALLS VIDEO PROCESSORS  
VIDEO MATRIX SWITCHES  
EXTENDERS SPLITTERS WIRELESS  
CABLES & ACCESSORIES

## HDMI 2.0a 4K@60 QUAD MULTIVIEWER W/ROTATION & USB VIDEO CAPTURE



**Model #: HDM2-SPLITPRO-T4K-V2**

© 2016 Avenview Inc. All rights reserved.

The contents of this document are provided in connection with Avenview Inc. ("Avenview") products. Avenview makes no representations or warranties with respect to the accuracy or completeness of the contents of this publication and reserves the right to make changes to specifications and product descriptions at any time without notice. No license, whether express, implied, or otherwise, to any intellectual property rights is granted by this publication. Except as set forth in Avenview Standard Terms and Conditions of Sale, Avenview assumes no liability whatsoever, and claims any express or implied warranty, relating to its products are strictly prohibited.

## TABLE OF CONTENTS

1.	GETTING STARTED.....	1
1.1	IMPORTANT SAFEGUARDS.....	1
1.2	SAFETY INSTRUCTIONS.....	1
1.3	REGULATORY NOTICES FEDERAL COMMUNICATIONS COMMISSION (FCC).....	2
2.	INTRODUCTION .....	3
2.1	FEATURES .....	4
2.2	PACKAGE CONTENT. ....	5
2.3	BEFORE INSTALLATION .....	5
2.4	APPLICATION DIAGRAM .....	6
3.	PANEL DESCRIPTION.....	7
3.1	INPUT PANEL (HDM2-SPLITPRO-T4K-V2) FRONT.....	7
3.2	INPUT PANEL (HDM2-SPLITPRO-T4K-V2) REAR.....	7
4.	IR REMOTE CONTROL.....	8
4.1	INSTALLATION AND CONTROL SOFTWARE .....	9
5.	SPECIFICATIONS.....	20



## SECTION I: GETTING STARTED

### I.1 IMPORTANT SAFEGUARDS

**Please read all of these instructions carefully before you use the device. Save this manual for future reference.**

#### **What the warranty does not cover**

- Any product, on which the serial number has been defaced, modified or removed.
- Damage, deterioration or malfunction resulting from:
  - Accident, misuse, neglect, fire, water, lightning, or other acts of nature, unauthorized product modification, or failure to follow instructions supplied with the product.
  - Repair or attempted repair by anyone not authorized by us.
  - Any damage of the product due to shipment.
  - Removal or installation of the product.
  - Causes external to the product, such as electric power fluctuation or failure.
  - Use of supplies or parts not meeting our specifications.
  - Normal wear and tear.
  - Any other causes which does not relate to a product defect.
- Removal, installation, and set-up service charges.

### I.2 SAFETY INSTRUCTIONS

The HDM2-SPLITPRO-T4K-V2 4x2 Quad multiviewer with 4K UHD input and output with USB capture, audio out and cloud control has been tested for conformance to safety regulations and requirements, and has been certified for international use. However, like all electronic equipments, the HDM2-SPLITPRO-T4K-V2 should be used with care. Read the following safety instructions to protect yourself from possible injury and to minimize the risk of damage to the unit.

- ⚠ Do not dismantle the housing or modify the module.
- ⚠ Dismantling the housing or modifying the module may result in electrical shock or burn.
- ⚠ Refer all servicing to qualified service personnel.
- ⚠ Do not attempt to service this product yourself as opening or removing housing may expose you to dangerous voltage or other hazards
- ⚠ Keep the module away from liquids.
- ⚠ Spillage into the housing may result in fire, electrical shock, or equipment damage. If an object or liquid falls or spills on to the housing, unplug the module immediately.
- ⚠ Have the module checked by a qualified service engineer before using it again.
- ⚠ Do not use liquid or aerosol cleaners to clean this unit. Always unplug the power to the device before cleaning.



## 1.3 REGULATORY NOTICES FEDERAL COMMUNICATIONS COMMISSION (FCC)

This equipment has been tested and found to comply with part 15 of the FCC rules. These limits are designed to provide reasonable protection against harmful interference in a residential installation.

Any changes or modifications made to this equipment may void the user's authority to operate this equipment.

Warning symbols	Description
	<p>ONLY USE THE PROVIDED POWER CABLE OR POWER ADAPTER SUPPLIED. DO NOT TAMPER WITH THE ELECTRICAL PARTS. THIS MAY RESULT IN ELECTRICAL SHOCK OR BURN.</p>
	<p>DO NOT TAMPER WITH THE UNIT. DOING SO WILL VOID THE WARRANTY AND CONTINUED USE OF THE PRODUCT.</p>
	<p>THE VIDEO BOARDS ARE VERY SENSITIVE TO STATIC. PLEASE ENSURE IF RACK MOUNTED OR INSTALLED ON A SURFACE, IT SHOULD BE IN A GROUNDED ENVIROMENT.</p>
	<p><b>⚠ WARNING</b></p> <p>Read &amp; understand user guide before using this device.</p> <p>Failure to follow the proper installation instructions could result in damage to the product and preventing expected results.</p>

## 2. INTRODUCTION

This 4 x2 multiviewer was developed for the purpose of supporting higher output resolution (**4K@60**) for multiple sources on a single screen with built in USB 3.0 FHD video capture to output 4K video to a computer.

This HDMI device can accept 4 HDMI 4K input digital sources and combine (4) four video signals onto a single HDMI UHD or HD monitor. The user can easily manage each input via the supplied Control Software and create any layout and position of any of the 4 (four) Inputs on a single monitor. This device supports full range of input video resolutions up to 4K and audio RCA breakout supported for external audio distribution systems. Audio channels can be selected to playback with input or can be muted.

**Fast Switching** – This device can input any 4 HDMI input digital sources and then combine, (4) four video signals onto a single HDMI UHD monitor. The user will benefit with from its processing power to switch between the 8 user defined function using control software via Ethernet or RS232, cloud, 4 IR Remote preset.

**Crop** – This device can Crop any 4 HDMI input digital sources to remove black bars and then combine, (4) four video signals onto a single HDMI HD monitor. This device can be configured using the supplied Control software via Ethernet or RS232 to set the desired layout on the connected screens.

**PIP, PAP, Overlay** – This device can input any 4 HDMI digital sources and then combine, (4) four video signals onto a single HDMI HD monitor, which the user can select picture in picture (PIP), picture Aside picture (PAP) or overlay with the supplied Control Software via Ethernet or RS232 to set the desired layout configuration.

**Window Scale and Position** – The user can easily change the individual channel size and choose different position and layout on the single monitor with the Control Software via Ethernet or RS232 to set the desired layout configuration.

**Scalable Rotation (90° & -90°)** – The user can easily Rotate/Scale only a single input/window image 90° left and right. This device can be configured with the Control Software, IR Remote, Ethernet, RS232 or front panel buttons.

**Cloud Control** –This device can be controlled via a cloud control platform where multiple units can be managed simultaneously.



## 2.1 FEATURES

- 4 HDMI 4K Inputs & 2 HDMI 4K Outputs (with one HDMI loop out up to 4K2K@60 (YUV 4:4:4) interlaced or progressive)
- Output resolution support up to 4K@60 (3840x2160);
- Output resolution support Full HD or to 4K@60 (3840x2160);
- USB 3.0 FHD Video Capture, UVC 1.0
- HDCP 1.4/2.2 compliant
- Fast switching between input channels and combined multiple images on single UHD display;
- Cropping the (4) four HDMI Input Channels;
- Supports PIP, PAP and multi-windows layout configurations;
- Single Input Rotation (90° left & right) functions;
- Background picture & logo support
- Resize, position, zoom & pan and blend output video
- Fade-in-&-out, wipe and dissolve transitions in full screen mode
- 8 preset Hot keys with 4 Custom layouts and 4 Full screen layouts within the supplied control software;
- 4 Custom saved layout buttons via the IR Remote;
- Input resolution support full range of video resolutions up to WUXGA@60 (RB) or full HD1080p;
- Uncompressed 7.1ch digital over HDMI
- RS 232 port for Service mode and firmware upgrade;
- Supports RS 232, Ethernet, IR Remote and front panel buttons and remote control via cloud platform.
- Factory Reset feature.



## 2.2 PACKAGE CONTENTS

Before you start the installation of the converter, please check the package contents.

1	HDM2-SPLITPRO-T4K-V2	X 1	
2	POWER SUPPLY (12V 5A)	X 1	
3	IR REMOTE	X 1	
4	RACKMOUNT BRACKET	X 2	
5	USER MANUAL	X 1	

## 2.3 BEFORE INSTALLATION

- Put the product in an even and stable location. If the product falls down or drops, it may cause an injury or malfunction. Don't place the product in too high temperature (over 50°C), too low temperature (under 0°C) or high humidity.
- Use the DC power adapter with correct specifications. If inappropriate power supply is used, then it may cause a fire.
- Do not twist or pull by force ends of the video cable. It can cause malfunction.



## 2.4 APPLICATION DIAGRAM

### HDM2-SPLITPRO-T4K-V2

MONITOR  
Preset layout 1

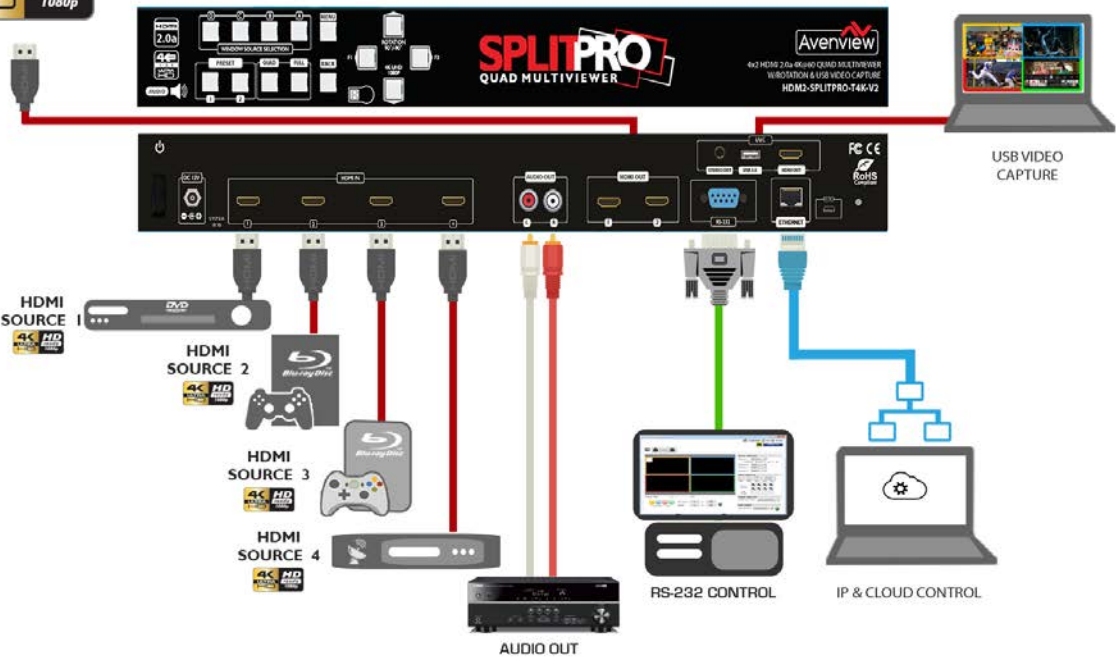
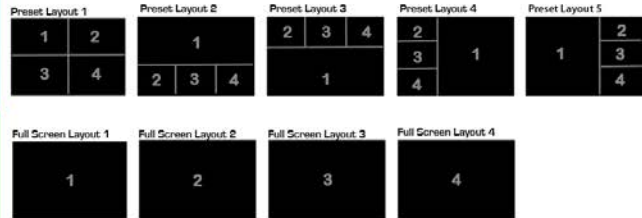



### 3. PANEL DESCRIPTION

#### 3.1 INPUT PANEL (HDM2-SPLITPRO-T4K-V2) Front



1. Preset Layouts	2.: Quad Screen / Full Screen Mode Buttons
3. IR Sensor: Receive IR commands from IR remote	4. Resolution Button: 4K UHD/1080p
5. Reserved Buttons: F1 & F2	6. Rotation Button: +90 & -90
7. OSD Menu: Menu control button	8. Window Source Selection: Source A/B/C/D

#### 3.2 INPUT PANEL (HDM2-SPLITPRO-T4K-V2) Rear

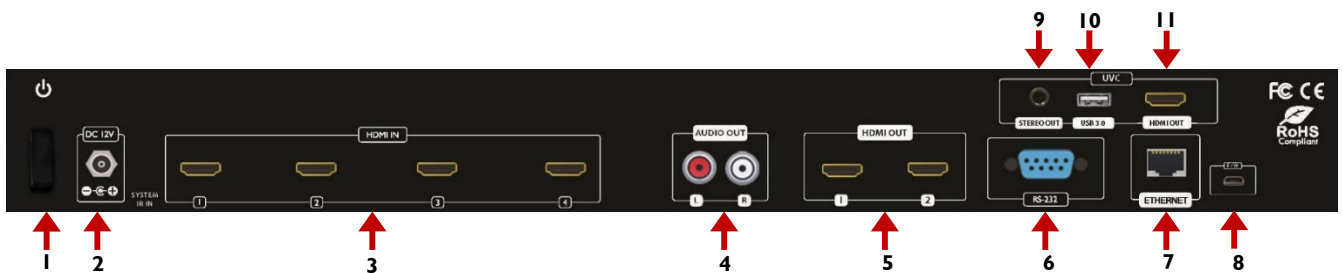

1. Power Switch	2. DC 12V: plug the 12V DC power supply into the unit supplied to an AC 110v outlet.
3. HDMI IN 1-4: Connect up to 4 HDMI devices to the INPUT ports 1-4( Blu-ray /Set-Top Box or PC)	4. Stereo Audio L/R: Connect red white audio RCA jacks to extract audio to an external audio source
5. HDMI OUT: Connect up to two HDMI 4K monitor/ Display to view the four inputs connected.	6. RS-232: D-Sub 9pin port for sending and controlling the unit by PC/Notebook via RS232 cable.
7. Ethernet: RJ45 jack for sending and controlling the unit by PC/Notebook via Ethernet cable.	8. Micro USB: Firmware update port
9. Stereo Audio Out: Audio from selected HDMI Inputs	10. USB Capture: Connect to computer to capture up to 4K video out
11. HDMI Loop out: Loop out port for display	

\* Some display/monitor brands the window border may have interference, adjusting the display's motion setting may resolve the interference issue.



## 4. IR REMOTE CONTROL

Button	Function
<b>POWER</b>	Power on/off the unit
<b>LOCK</b>	Lock/unlock the unit
<b>▲</b>	Navigate up
<b>MENU</b>	OSD menu
<b>AUDIO</b>	Select audio sources
<b>▶</b>	Navigate right
<b>OK</b>	Select the setting
<b>◀</b>	Navigate left
<b>MUTE</b>	Turn off the audio
<b>BACK</b>	Back to previous page of OSD menu
<b>▼</b>	Navigate down
<b>EXIT</b>	Exit menu
<b>F1</b>	Reserved
<b>720P</b>	Enable 720p 60Hz output resolution
<b>1080P</b>	Enable 1080p 60Hz output resolution
<b>4K2K</b>	Enable 4K2K 60Hz output resolution
<b>QUAD</b>	Fast switch to quad-view mode
<b>FULL</b>	Fast switch to full screen mode
<b>Background</b>	To set up the background picture of window
<b>LABEL</b>	Window label ON/OFF
<b>Window A</b>	Select source A to be the input source
<b>Window B</b>	Select source B to be the input source
<b>Window C</b>	Select source C to be the input source
<b>Window D</b>	Select source D to be the input source
<b>Preset 4</b>	User preset 4
<b>Preset 3</b>	User preset 3
<b>Preset 2</b>	User preset 2
<b>Preset 1</b>	User preset 1

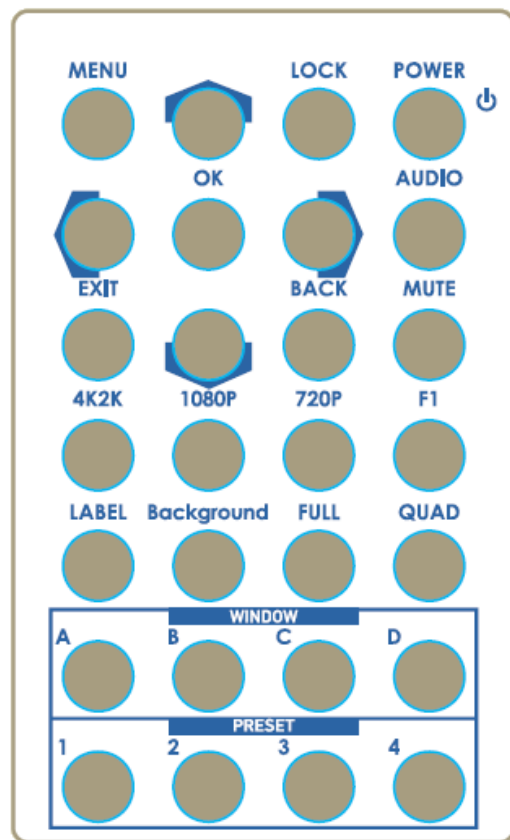

## 4.1 INSTALLATION (HDM2-SPLITPRO-T4K-V2)

### HARDWARE SETUP

To setup Avenview HDM2-SPLITPRO-T4K-V2 follow these steps below:

1. Mount or fix the HDM2-SPLITPRO-T4K-V2 on a secure shelf, AV rack or steady surface;
2. Ensure the power is off on the HDM2-SPLITPRO-T4K-V2, all source devices and displays that will be connected;
3. Connect your (4) four HDMI cables to the (4) four HDMI sources such as (Blu-ray player, Laptop or Set-Top-Box or Gaming device);
4. Connect your HDMI cables to the single HD Displays, LCD or PC monitors that is receiving the video signals.
5. Power on all devices.
6. Connect your computer to HDM2-SPLITPRO-T4K-V2 via RS232, RS-232 to USB or Ethernet cable in order to control via Telnet or RS232.

### SERIAL PORT SETTING

#### RS-232 Wiring (Cross Cable Connection)

Remote Controller(PC)	
PIN	Assignment
1	NC
2	TxD
3	RxD
4	NC
5	GND
6	NC
7	NC
8	NC
9	NC



HDM-SPLITPRO-4K-V2	
PIN	Definition
1	NC
2	RxD
3	TxD
4	NC
5	GND
6	NC
7	NC
8	NC
9	NC

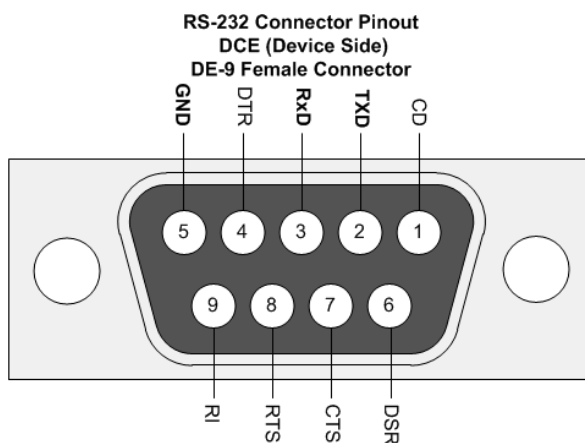
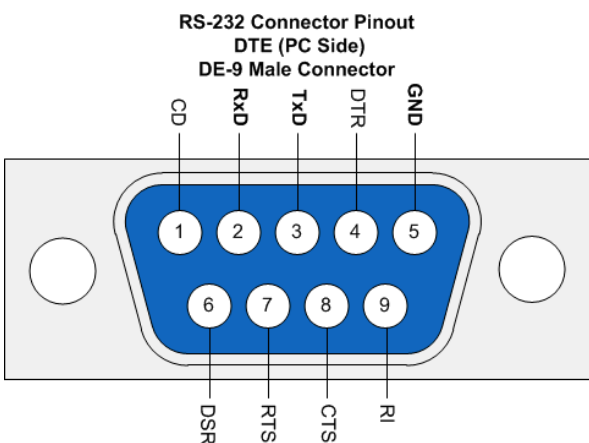

RS-232 SETTINGS

Baud Rate: 115200bps  
Data Bit: 8 bits  
parity: None  
flow Control: None  
Stop Bit: 1



### Control through RS-232 port / Ethernet port

1. Please note when power cycling device, please restart unit at least 5 to 15 seconds after to allow the power capacitors to discharge.
2. The HDM2-SPLITPRO-T4K-V2 PC control software operates with Microsoft Windows 98, 2000, XP, 7, 8 through the interface of Ethernet or RS-232 serial control.
3. Through software and COM port you can assign an IP address before connecting via RJ45.

**Please NOTE: (Under Microsoft Windows 7, please run software as administrator).**

Once the software is installed click on the ICON, the following dialog will pop-up. First time connection, please connect via RS232 serial cable.

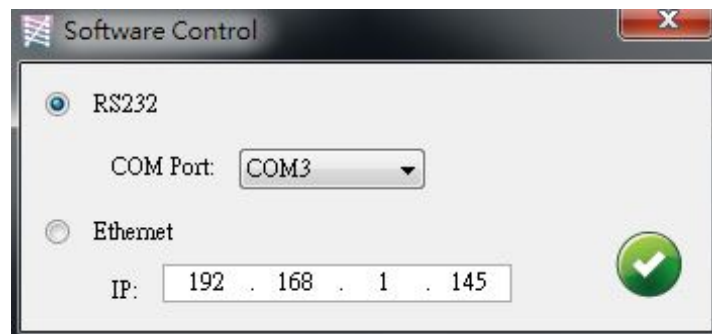

RS-232 serial Mode: Use RS-232 to connect the port on device and computer. Select the correct COM port and click the OK button.

Ethernet Mode: Enter the IP address of the device and click the OK button and power cycle the unit.

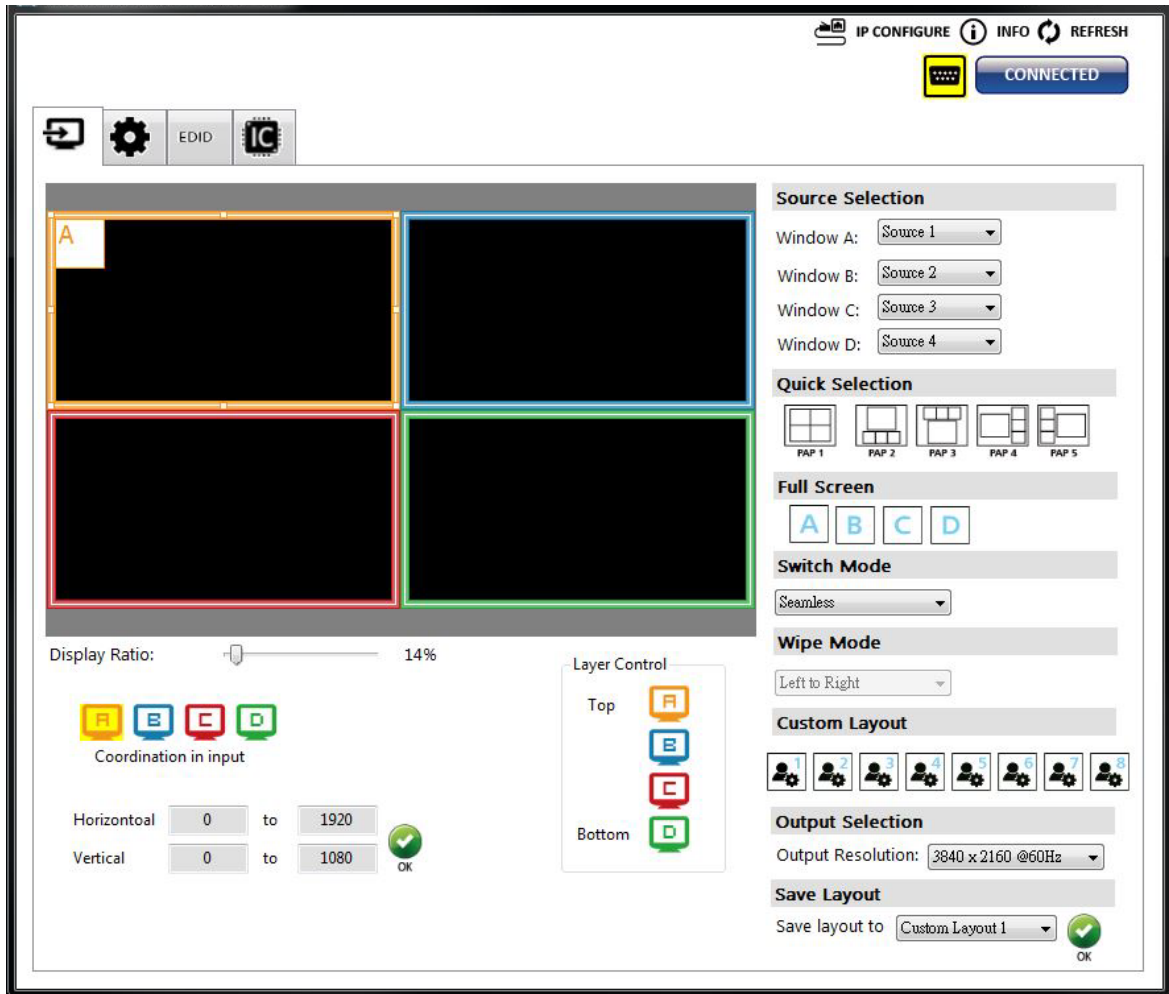



### I. Connection Status:

This shows the active connection status. If connected by RS-232 serial Mode device, the icon is . If connected by ethernet . Easily change the control method, by clicking on the  button.

### 2. Output Settings

Users can set up the designated inputs, to each window A~D or duplicate, output resolution, PAP predefined layout setting or single input rotation.

#### (1) Source Selection

For each display window, you can assign the video source the caption below:

#### Source Selection

Window A:

Window B:

Window C:

Window D:

## (2) Quick Selection Tabs

Provided in the software 9 default modes (5 PAP and 4 Full Screen) and 8 custom modes for you to create. Switching effects include (Seamless, Fade in/out, Dissolve, Wipe)

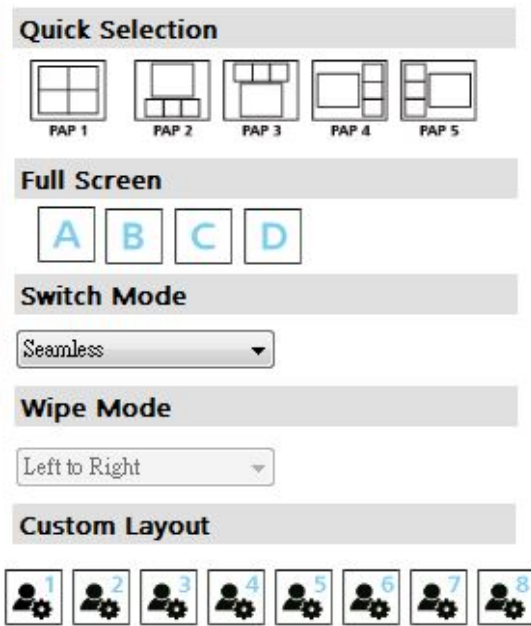

## (3) Output Resolution

Set the output resolution from 640x480-4K@60 to match the connected Monitor Timings

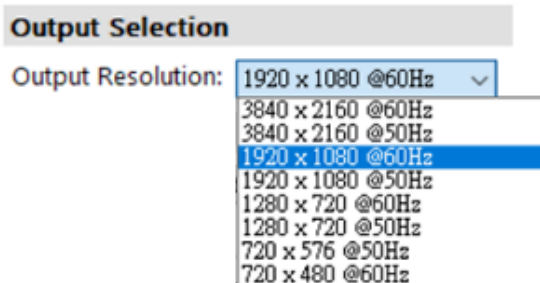

## (4) Save Layout

Also the user can define their own 8 custom layouts and save the frequently used scenarios into the flash memory.

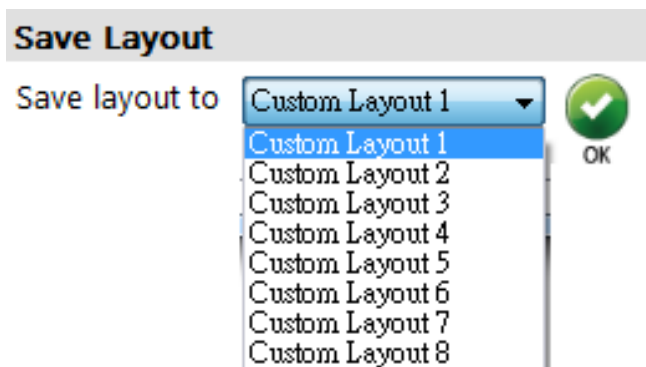

### (5) Display Panel



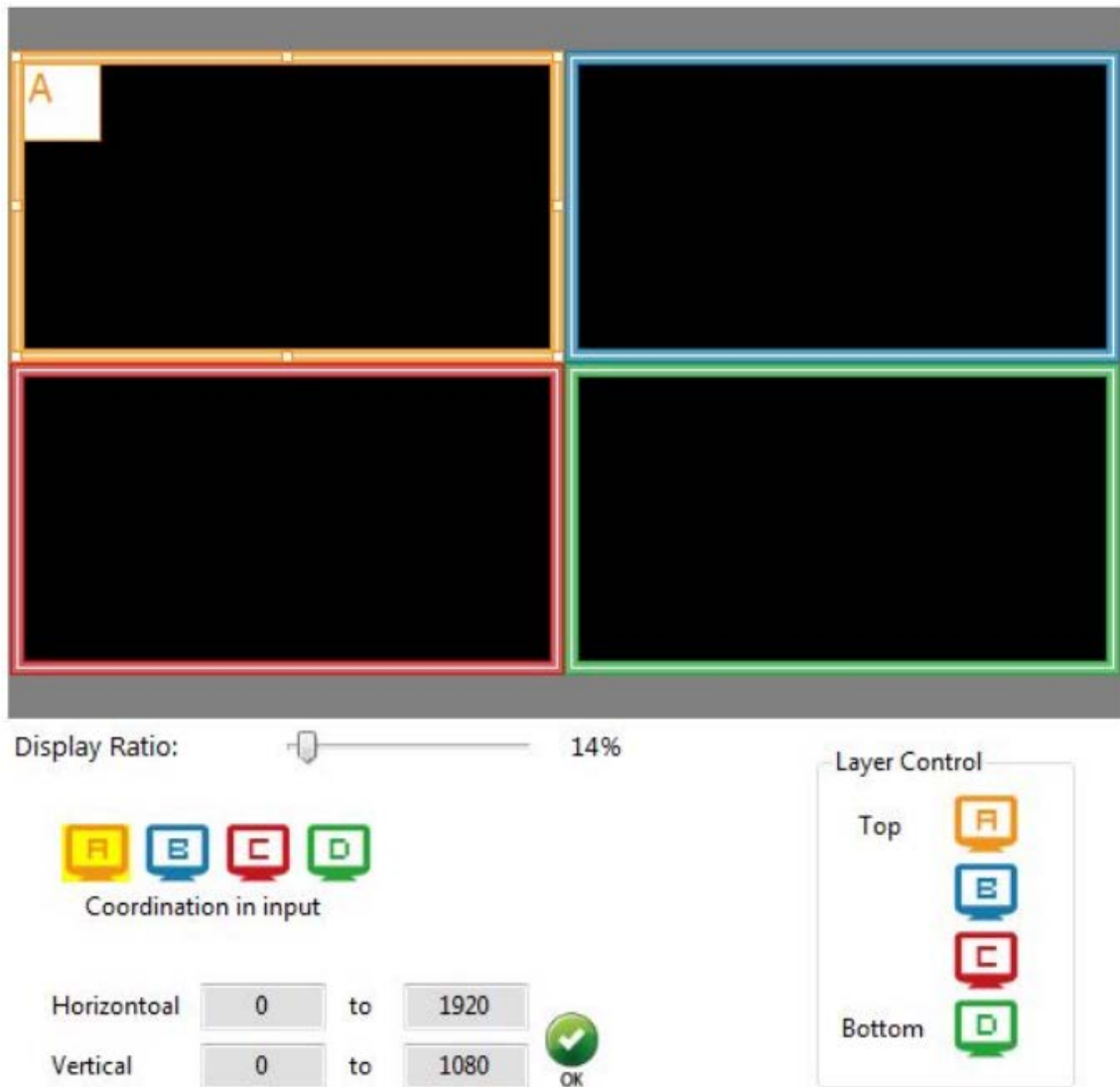

As illustrated below, users can resize any window by simply dragging the highlighted box with the mouse and immediately see the results on the attached monitor. The different colors of the frames represent the different inputs for easy identification. The Horizontal and Vertical coordinate shows the position of input source on the screen. In addition, the display ratio can be adjusted to view the layout in software (Zoom in Zoom out).

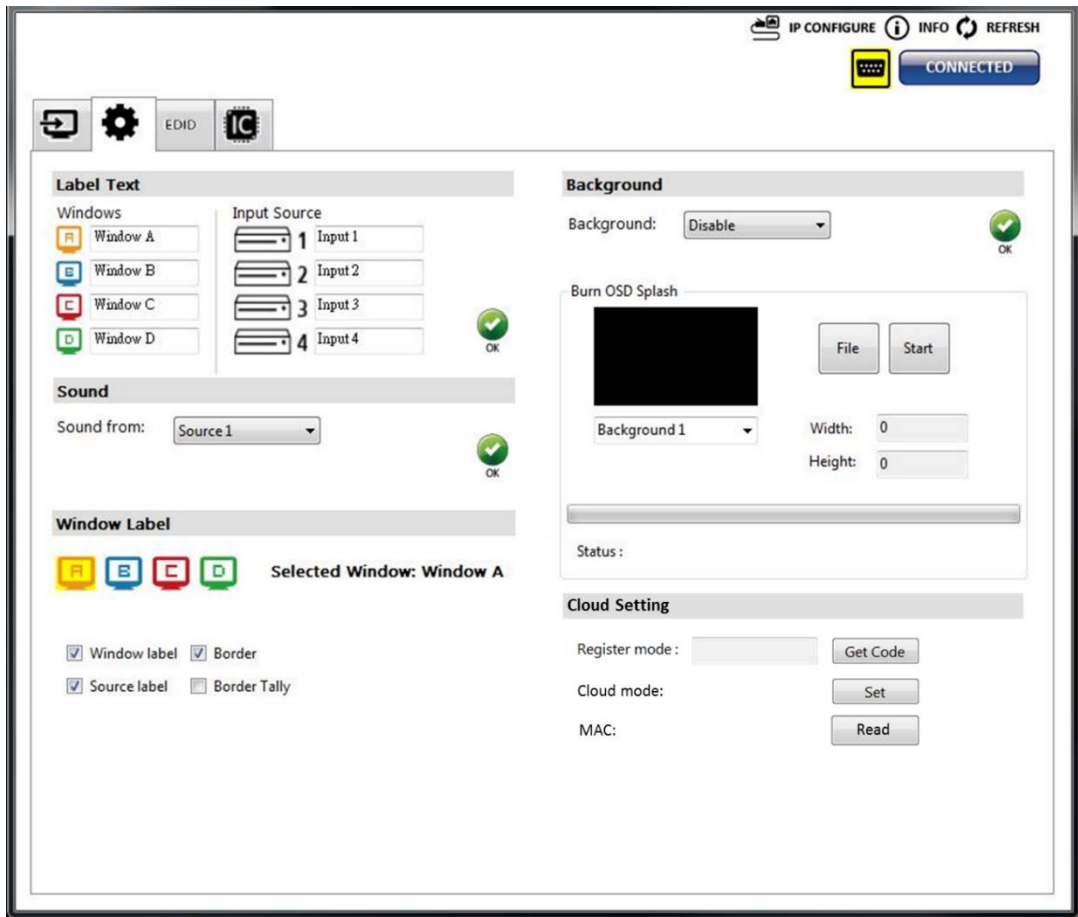

### 3. Advanced Setting



#### (1) Window settings

Users can adjust each display area and input source as desired. To proceed with this function user have to click on the specific channel A, B, C, or D, as indicated by the icons     in the control panel as shown above. After the specific channel is chosen, users can click on the "CROP ENABLE" box, then crop the display area of that and other channels. The control panel of the software illustrates by preview on how those settings would be presented at the output. Using "DIVIDE- Horizontal/Vertical"

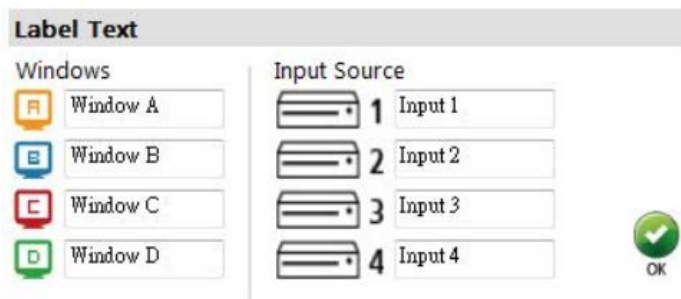

#### (2) Label Text

In here, users can easily rename /label the input to be shown on the window with the video to identify the input.





(3) Sound

To set and match which audio source to the output video through the R/L channels.



(4) Background

To set up the background of each window. The CS has 4 default pictures for the user to select. To change the default picture, please click the **File** button to select the picture that would be used choose

slot **Background 1** for the image save reference then select **Start**

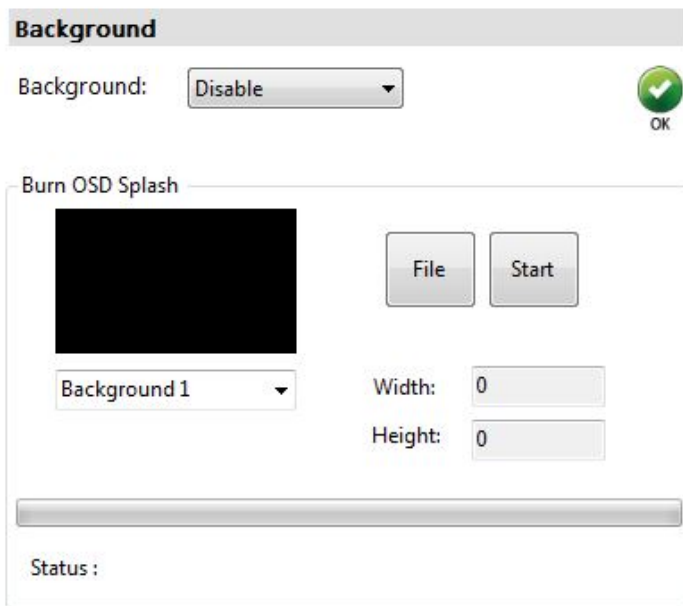

(5) Window Label

Users can simply determine if the window's label/border can be shown or invisible.

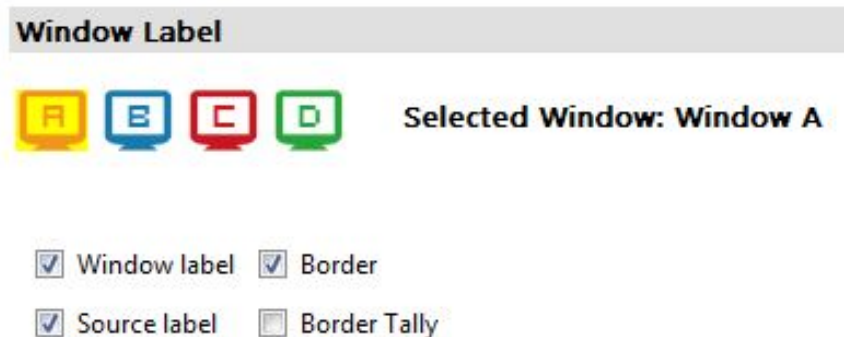

## (6) Cloud Setup

**Cloud Setting**

Register mode :

Cloud mode:

MAC:

Register Mode:  get an association code to pair unit with cloud server.

Cloud Mode:  resets cloud aster paired

MAC: Gets and displays Device Ethernet port MAC address

## 4. EDID (Extended Display Identification Data)

Learn EDID

From Default:

To:

From Display:

To:

### (I) Learn EDID from Default

- Select Default EDID

1. Full-HD(1080p@60)-24bit 2D &2ch

1. Full-HD(1080p@60)-24bit 2D &2ch

2. HD(1080i/720p@60)-24bit 2D &2ch

- Select Input

Input 1

Input 1

Input 2

Input 3

Input 4

All Inputs

- Click  button to learn default EDID.



## 5. System Setting



### (I) Firmware Update

- Click  FIRMWARE UPDATE button to perform authorized firmware update.
- The “Firmware update” window pops up as below.



- Please select the correct COM port or click “Scan” button to connect device.



- Click “update” button to do firmware update.

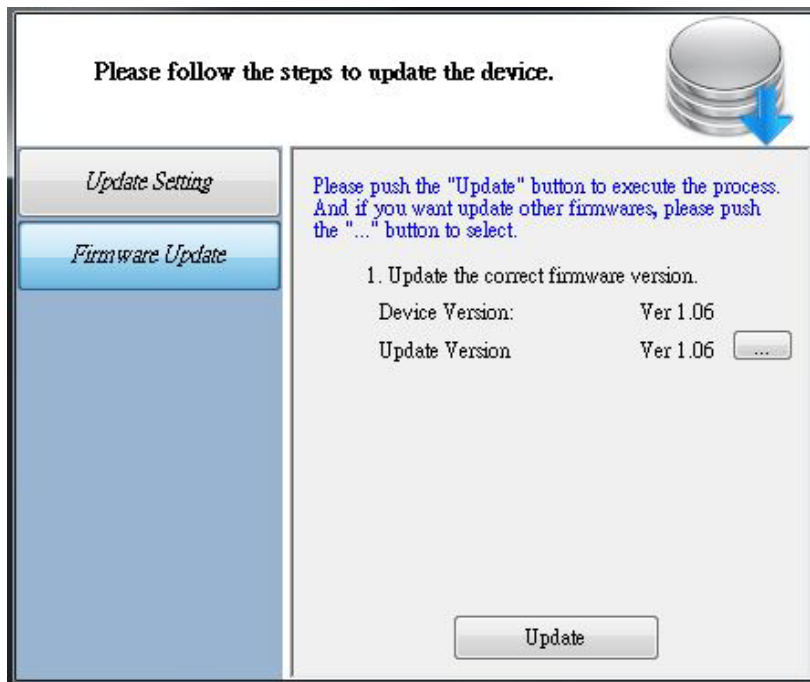

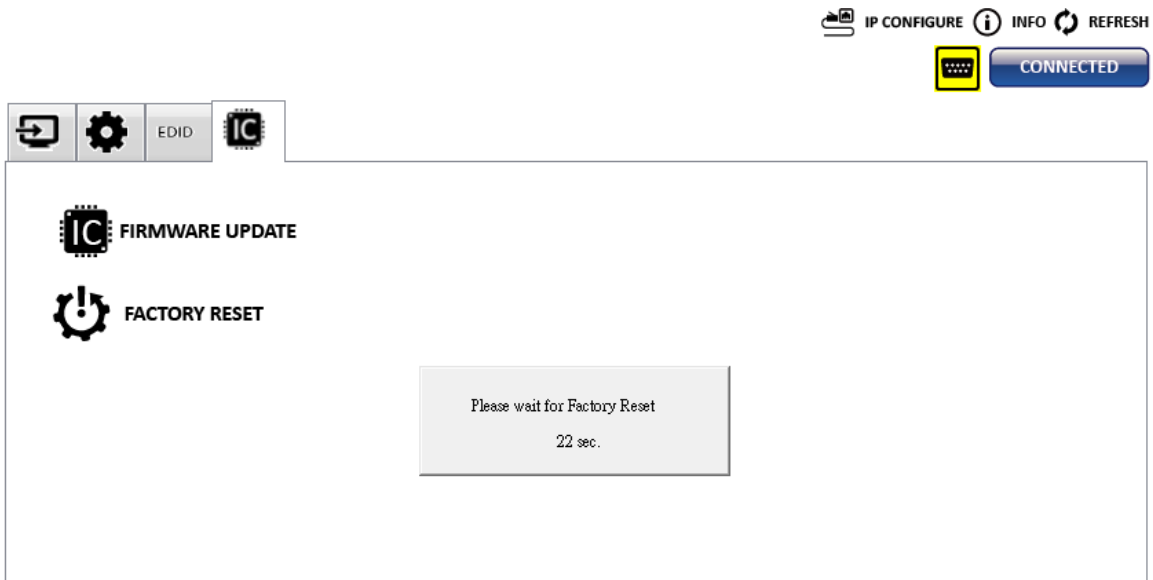

## (2) Factory Reset

- Click  **FACTORY RESET** button to perform a factory default reset.
- The process will take approx. 25 seconds.



## 6. IP Configure

To use Ethernet control users should click on the  **IP CONFIGURE** button to set the network IP range. Please see the caption below. After the information has been complete, please click the  button.

The default IP: **192.168.1.46**

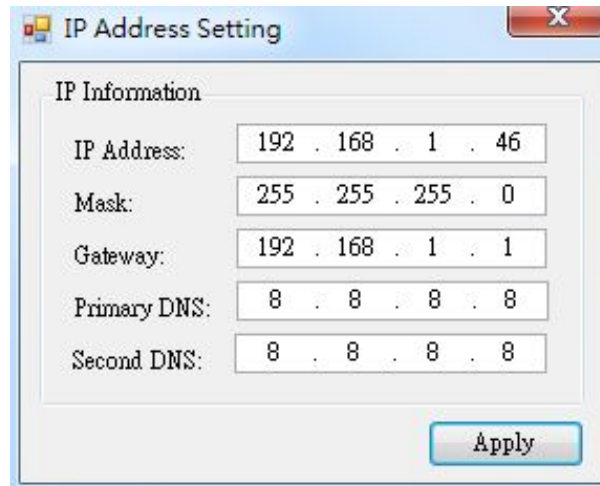

IP Information	
IP Address:	192 . 168 . 1 . 46
Mask:	255 . 255 . 255 . 0
Gateway:	192 . 168 . 1 . 1
Primary DNS:	8 . 8 . 8 . 8
Second DNS:	8 . 8 . 8 . 8

Apply

## 7. Info

Displays the Software and firmware version.



Version	
Software Version:	Ver 1.0
Firmware Correct Version - 1:	Ver 1.06

Status	
Firmware Device Version - 1:	Ver 1.06

*Software/firmware information is subject to change without prior notice*

## 8. Refresh

This function will gather the changes made within software and hardware. Then update the software interface state with its current info.



## 9. Cloud Control (Eagleyes) through Ethernet Port

### Create Account

The first time to use the Eagleyes service, please create a new account.

1. Access Eagleyes (<http://www.eagleyes.io>) and click "Create new account".

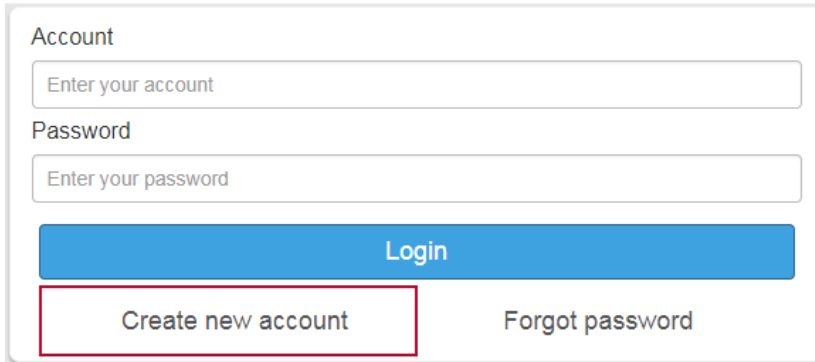

2. The Registration page will pop up and please fill in your email and password information to create your private account.

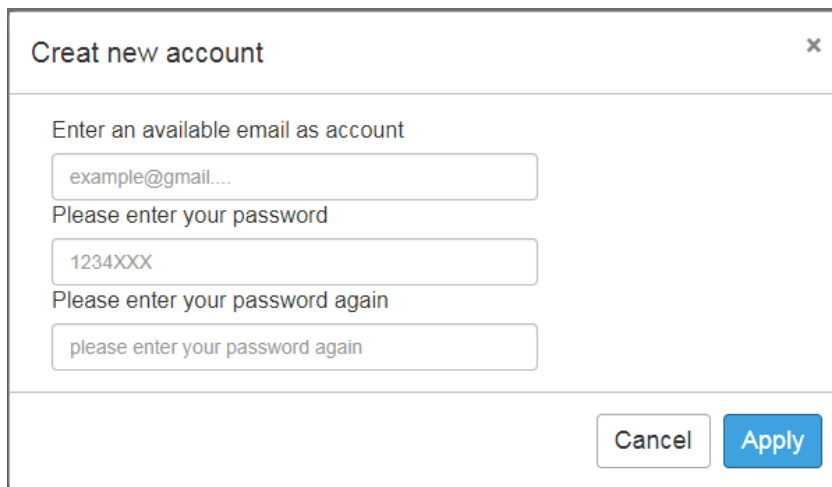

### Add Device to Eagleyes

1. Firstly, please make sure the device is connected to the Ethernet. Then please executing the software with device to get the register code (Note: the status of software is connected).

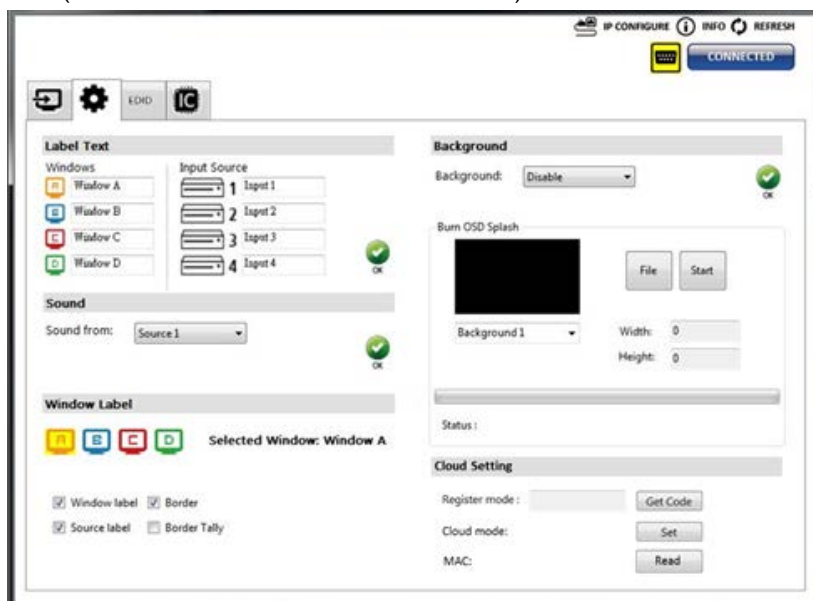

2. Access Eagleyes (<http://www.eagleyes.io>), and then log in your account on the right top corner. Click **Add device** to add the device which you just got its association code.

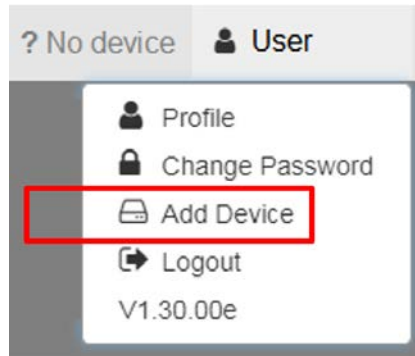

3. Enter the Installer Email for online support in the future, and the Association Code for pairing with your device.

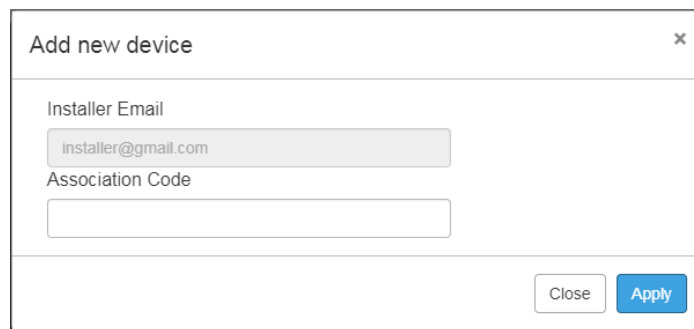

4. After adding the device, the list of device related to your account will show on the right top corner. You can click the button to switch device for control.

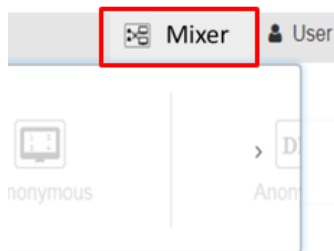

## 5. SPECIFICATIONS

Item	Description
<b>UNITS</b>	HDM2-SPLITPRO-T4K-V2
<b>UNIT DESCRIPTION</b>	4xI HDMI 2.0 Quad multiviewer with Rotation, 4K@60 support on output
<b>HDCP COMPLIANCE</b>	Yes 2.2
<b>VIDEO BANDWIDTH</b>	HDMI 600MHz [18Gbps]
<b>HDMI COMPLIANCE</b>	Input: HDMI 1.4 /Output: HDMI 2.0a
<b>VIDEO FORMAT SUPPORT</b>	HDMI 2.0
<b>INPUT SUPPORTED RESOLUTIONS</b>	720p 50Hz, 720p 60Hz, 1080p 24Hz, 1080p 25Hz, 1080p 30Hz, 1080p 50Hz, 1080p 60Hz, 1920X1200 Hz, 3840x2160 60 Hz and 4K2K@60 (4:4:4 8bits)
<b>OUTPUT SUPPORTED RESOLUTIONS</b>	720p 50Hz, 720p 60Hz, 1080p 24Hz, 1080p 25Hz, 1080p 30Hz, 1080p 50Hz, 1080p 60Hz, 1920X1200 Hz, 3840x2160 60 Hz and 4K2K@60 (4:4:4 8bits)
<b>USB VIDEO SUPPORT</b>	Up to 1080p 60Hz
<b>USB VIDEO FORMAT</b>	YUY2 (USB3.0), MJPG (USB2.0/3.0)
<b>USB CONNECTOR</b>	USB 3.0 Type A (SuperSpeed USB)
<b>AUDIO SUPPORT</b>	Bypass LPCM 2CH, 6CH, 8CH/AC3/DTS/Dolby Digital Plus/ Dolby TruHD/DTS-HD
<b>INPUT</b>	4x HDMI + 1xRS-232 + 1x RJ-45(Ethernet) + 1x 3.5mm (IR)
<b>OUTPUT</b>	3x HDMI + 1x USB + 2x RCA + 1x 3.5mm
<b>CONTROL</b>	RS 232 / IP Control / IR / Front Panel / Cloud
<b>RJ45 CONNECTOR</b>	WE/SS 8P8C with 2 LED indicators
<b>ESD PROTECTION</b>	Human body model — ±15kV [air-gap discharge] & ±8kV [contact discharge]
<b>WEIGHT</b>	3.3 lbs.
<b>DIMENSIONS (L X W X H)</b>	12.5" x 6.8" x 1.7"
<b>POWER SUPPLY</b>	12V/5A DC (US/EU standards, CE/FCC/UL certified)
<b>POWER CONSUMPTION</b>	22W

### *Environmental*

<b>OPERATING TEMPERATURE</b>	32° ~ 104°F (0° to 40°C)
<b>STORAGE TEMPERATURE</b>	-4° ~ 140°F (-20° ~ 60°C)
<b>RELATIVE HUMIDITY</b>	20~90% RH (no condensation)





## Avenview Warranty Certificate

AVENVIEW CORP. ("Avenview") warrants Avenview-branded product(s) contained in the original packaging against defects in materials and workmanship when used normally in accordance with Avenview's enclosed manual guidelines for a period of THREE (3) YEARS from the date of original retail purchase - Warranty Period. Avenview's published guidelines include but are not limited to information contained in technical specifications, user manuals and service communications.

**LABOR:** During the Warranty Period of THREE (3) YEARS, Avenview will repair or replace the product(s) at no cost using new or used parts equivalent to novel performance and reliability if the product(s) is determined to have abide by Avenview's published guidelines. Cost of Labor applicable to product(s) after Warranty Period. For labor costs, please contact [support@avenview.com](mailto:support@avenview.com).

**PARTS:** During the Warranty Period of THREE (3) YEARS, Avenview will supply new or rebuilt replacements in exchange for defective parts of the product(s) at no cost if the product(s) is determined to have abide by Avenview's published guidelines. Cost of Parts applicable to product(s) after Warranty Period. For part(s) costs, please contact [support@avenview.com](mailto:support@avenview.com).

To obtain Warranty: (a) proof of purchase in the form of a bill of sale or receipted invoice reflecting that the registered product(s) is within warranty period must be presented to obtain warranty service; (b) product(s) must be registered at time of purchase. Failure to do so will result in applicable parts and labor charges. Returning product(s) must be shipped in Avenview's original packaging or in packaging pertaining equal degree of protection to Avenview's. Both Avenview and purchaser are responsible for freight charges and brokerages when shipping the product(s) to the receiver.

### NOT COVERED BY THIS WARRANTY

This warranty does not apply to any non-Avenview branded product(s); non-registered Avenview product(s). This warranty does not apply: (a) to cosmetic damage, including but not limited to scratches, dents and broken cords; (b) to damage caused by use with another product; (c) to damage caused by accident, abuse, misuse, liquid contact, fire, earthquake or other external cause; (d) to damage caused by operating the Avenview product(s) outside Avenview's manuals or guidelines; (e) to damage caused by service performed by anyone who is not a representative of Avenview or an Avenview authorized personnel; (f) to defects caused by normal wear and tear or otherwise due to the normal aging of the Avenview product(s), or (g) if any serial number has been removed or defaced from the Avenview product(s).

AVENVIEW IS NOT LIABLE FOR DIRECT, SPECIAL, INCIDENTAL OR CONSEQUENTIAL DAMAGES RESULTING FROM ANY BREACH OF WARRANTY OR CONDITION, OR UNDER ANY OTHER LEGAL THEORY, INCLUDING BUT NOT LIMITED TO LOSS OF USE; LOSS OF REVENUE; LOSS OF ACTUAL OR ANTICIPATED PROFITS (INCLUDING LOSS OF PROFITS ON CONTRACTS); LOSS OF THE USE OF MONEY; LOSS OF ANTICIPATED SAVINGS; LOSS OF BUSINESS; LOSS OF OPPORTUNITY; LOSS OF GOODWILL; LOSS OF REPUTATION; LOSS OF, DAMAGE TO, COMPROMISE OR CORRUPTION OF DATA; OR ANY INDIRECT OR CONSEQUENTIAL LOSS OR DAMAGE REPAIR OR REPLACEMENT AS PROVIDED UNDER THIS WARRANTY IS THE EXCLUSIVE REMEDY OF THE CONSUMER.

Some states do not allow the inclusion or limitation of incidental or consequential damages, or allow limitations on duration implements of the Warranty Period; therefore, the above limitations or exclusions may not be applicable to you. This warranty gives you specific legal rights, and you may have other rights which vary from state to state.



1100 Military Road, Kenmore, NY 14217  
1.866.508.0269





Control Your Video

## TECHNICAL SUPPORT

### CONTACT US



Phone: 1 (866) 508 0269



Email: [support@avenview.com](mailto:support@avenview.com)



#### **Avenview Canada**

151 Esna Park Drive, Unit 11-12  
Markham, ON L3R 3B1  
Phone: +1 905 907 0525  
Email: [info@avenview.com](mailto:info@avenview.com)  
Sales: [sales@avenview.com](mailto:sales@avenview.com)

#### **Avenview USA**

1100 Military Road  
Kenmore, NY 14217  
Phone: +1 716 218 4100 x223  
Fax: +1 866 387 8764  
Email: [info@avenview.com](mailto:info@avenview.com)

#### **Avenview Europe**

Phone: +31 085 2100613  
Email: [info@avenview.eu](mailto:info@avenview.eu)

#### **Avenview Asia**

Email: [wenxi@avenview.com.hk](mailto:wenxi@avenview.com.hk)  
Sales: [sales@avenview.com.hk](mailto:sales@avenview.com.hk)

#### **Disclaimer**

While every precaution has been taken in the preparation of this document, Avenview Inc. assumes no liability with respect to the operation or use of Avenview hardware, software or other products and documentation described herein, for any act or omission of Avenview concerning such products or this documentation, for any interruption of service, loss or interruption of business, loss of anticipatory profits, or for punitive, incidental or consequential damages in connection with the furnishing, performance, or use of the Avenview hardware, software, or other products and documentation provided herein.

Avenview Inc. reserves the right to make changes without further notice to a product or system described herein to improve reliability, function or design. With respect to Avenview products which this document relates, Avenview disclaims all express or implied warranties regarding such products, including but not limited to, the implied warranties of merchantability, fitness for a particular purpose, and non-infringement.