

ST-C6HD-394-LC

HDMI Extender

User Manual



Thank you for purchasing this product. For optimum performance and safety, please read the instructions carefully and keep the manual for future reference.

- **Important Safety Notice**

Please read below safety instructions carefully before installation and operation:

1. Do not hot plug.
2. Do not mix up the transmitter unit (TX) and the receiver unit (RX) , IR blaster extension cable and IR receiver extension cable before installation.
3. Use DC5V/1A power supply only. Make sure specification matches if using adapters not supplied by factory.

- **Introduction**

This HDMI Extender is a solution for transmission and extension uncompressed full HD 1080p@60Hz HDMI signal over a signal CAT5/5e/6 network cable. It includes a transmitter unit (TX) and a receiver unit(RX), working as a pair. Long transmission distance is up to 120 meters with zero latency. This HDMI Extender support IR passback for remote control source device from receiver site easily. This product is perfect for AV transmission in applications of HD conference system, HD video shooting, HD multimedia education system, HD digital advertising and signage etc.

- **Feature**

1. Plug and play, no software required.
2. Includes a transmitter unit (TX) and a receiver unit (RX), working as a pair.
3. Transmission distance up to 120m via CAT6 cable, 100m via CAT5E cable, 80m via CAT5 cable.
4. Support IR passback for remote control source device to receiver site easily.

5. Uncompressed and zero latency.
6. Supports resolution is up to full HD 1080p@60Hz.
7. Compliant with CAT5/5e/6 for long distance transmission.

• Package Contents



Transmitter unit
(TX) ×1pcs



Receiver unit
(RX) ×1pcs



User manual×1pcs

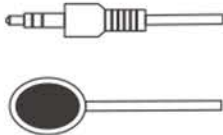

IR blaster
extension cable ×1pcs

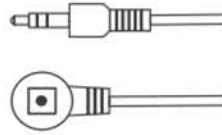

IR receiver
extension cable×1pcs

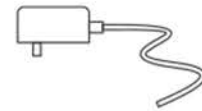

Power supply×2pcs
(See last page for details on
power supply plug provided)

• Installation Requirements

1. HDMI source device(computer graphics card, DVD,PS3, HD monitoring equipment etc).
2. HDMI display device like SDTV, HDTV, projector with HDMI port.
3. UTP/STP CAT5/5e/6 cable, follow standard IEEE-568B.

• Description

1. Transmitter unit(TX)

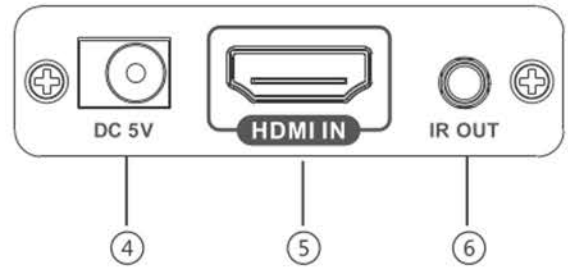
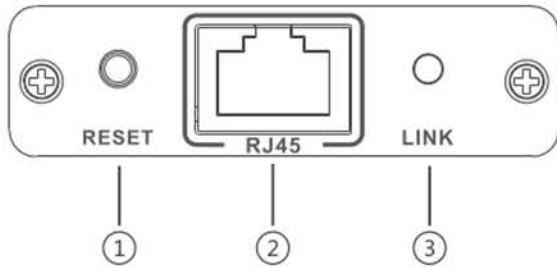

①	Reset button	Restart the unit
②	RJ45 signal output	Connect with network cable
③	LINK indicator	LED turns on all the time with HDMI signal transmission, flashes with no signal transmission
④	Power input	Connect with DC5V1A power adapter
⑤	HDMI signal input	Connect with source device
⑥	IR signal output	Connect with IR blaster extension cable

2.Receiver unit (RX)

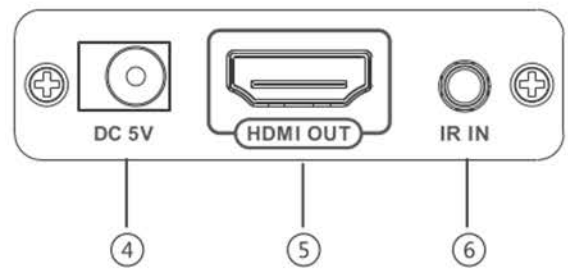
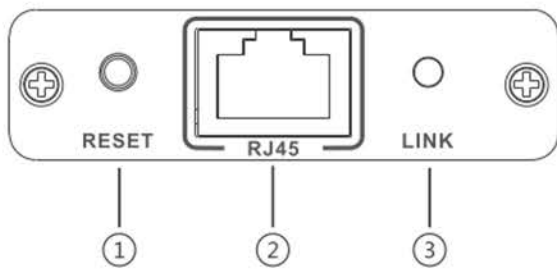

①	Reset button	Restart the unit
②	RJ45 signal input	Connect with network cable
③	LINK indicator	LED turns on all the time with HDMI signal transmission, flashes with no signal transmission
④	Power input	Connect with DC5V1A power adapter
⑤	HDMI signal output	Connect with display device
⑥	IR signal input	Connect with IR receiver extension cable

• Installation and Connection

1. How to make a CAT5/5E/6 network cable Follow the standard of IEEE-568B:



1. white and orange; 2. orange; 3. white and green;
4. blue; 5. white and blue; 6. green;
7. white and brown; 8. brown.

2. Connection

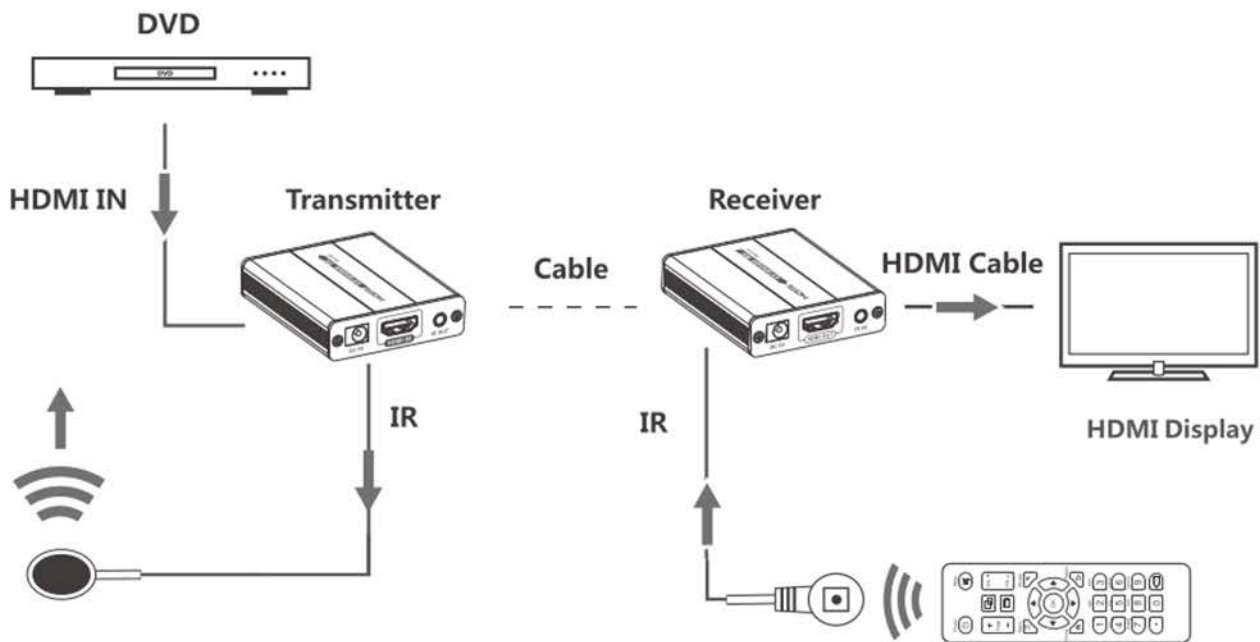

3. Connection instruction

- 1) Connect source device to Transmitter unit (TX), and display device to Receiver unit (RX) via HDMI cables
- 2) Connect Transmitter unit (TX) and Receiver unit (RX) via network cables (CAT5, CAT5e or CAT6)
- 3) Plug the power supplies into the Transmitter and Receiver. Each will then initialize and be ready to use.

4. IR User Guide

- 1) IR blaster extension cable should plug into the IR OUT port of TX (Transmitter) unit of HDMI extender, and the IR receiver extension cable should plug into the IR IN port of the RX(Receiver) unit.
- 2) The emitter of IR blaster should be as close as possible to the IR receiver window of the signal source device.
- 3) Point the IR remote controller of the signal source device towards the IR receiver (connected to the RX) and control the source media remotely.

• **FAQ**

Q: No image output?

A: 1) Check and make sure all cables are connected well;
2) Restart the TX/RX by using the "RESET" button.

Q: RX "LINK" indicator is flashing all the time?

A: 1) Make sure network cable connection follows the standard of IEEE568B;
2) Check whether transmitter has HDMI signal input;
3) Reset transmitter and receiver and reconnect.

Q: Receiver "LINK" led lights on all the time but no image output?

A: 1) Make sure the monitor supports the current HDMI signal mode;
2) Make sure HDMI cable is well connected with TV;
3) Make sure the network cable is in good condition.

• Specification

Items		Specification
Power Supply	Voltage/Current	DC5V/1A
	Power consumption	TX: 2W RX: < 2W
HDMI Performance And Interface	HDMI compliance	HDMI1.3
	HDCP compliance	HDCP1.4
	HDMI resolution	720x576@50Hz, 720x480@60Hz, 1280x720@60Hz, 1920x1080@60Hz, 640x480@60Hz, 800x600@60Hz, 1024x768@60Hz, 1280x800@60Hz, 1280x1024@60Hz, 1440x900@60Hz, 1680x1050@60Hz
	Supports audio formats	PCM, LPCM, Dolby Digital and DTS
	Maximum transfer rate	10.2Gbps
	Input and output TMDS signal	0.5 ~ 1.5Vp-p(TMDS)
	Input and output DDC signal	5Vp-p(TTL)
	Input cable length	≤8m(AWG24) *
Output cable length	≤8m(AWG24)	
Transmission length	CAT5	80m
	CAT5E	100m
	CAT6	120m
Protection Level	Electrostatic protection of the whole machine	1a contact discharge level 3, 1b air discharge level 3, implementation of the standard: IEC61000-4-2
Operating Environment	Working temperature	0 ~ 60°C
	Storage temperature	-10 ~ 70°C
	Humidity (no condensation)	0 ~ 90%
Body Properties	Dimension	69.57(L) x 58.80(W) x 16.10(H)mm
	Material	Aluminium alloy material + crystal panel
	Treatment process	Grit blast
	Color	Black
	Weight	TX:70g, RX:70g

*Works with NTI HDMI Cables up to 20 feet (HD-xx-MM), all lengths of HDMI Redmere Active Cables (HD-RM-xx-MM), and all lengths of HDMI to DVI Cables (up to 5 meters) (DVI-HD-xM-MM).

Power Supply

The ST-C6HD-394-LC comes with two power supplies, one for the Transmitter, one for the Receiver. The type of power supply provided depends on the model ordered, which determines the type of plug that will be included to connect to your power source.

Model	Power Cord Plug Supplied
ST-C6HD-394-LC	US NEMA 1-15P
ST-C6HD-394-LCEU	Europlug CEE 7/16
ST-C6HD-394-LCUK	UK BS1363
ST-C6HD-394-LCAU	AS/NZS 3112
ST-C6HD-394-LCUNVxx	US NEMA 1-15P with country-specific universal power plug adapter

The ST-C6HD-394-LCUNVxx will include a universal power plug suitable for the power connections found in the country the power supply was ordered for (xx).

xx	Country
ZA	South Africa
IT	Italy
CH	Switzerland
IN	India
UK	United Kingdom
RU	Russia
IL	Israel
AU	Australia
EU	Europe
DK	Denmark