

ST-IPHD-POELC

Low-Cost HDMI Over Gigabit IP Extender
with IR and Power over Ethernet (POE)

User manual



• INTRODUCTION

HDMI HDbiT extender, takes the advantages of the latest transmission technology - HDbiT, extends your HDMI video/audio with the resolution of 1080p 60Hz up to 120m(394 feet) via single network cable. Supports IR signal transmission, to control media playback of the signal source device at the display location. Supports POE.

Important Safety instructions:

1. Do not mix up the HDMI EXTENDER sender and HDMI EXTENDER receiver, and the IR blaster and IR receiver.
2. Do not plug-in/out the cables ,when it is in use.
3. Support and compliant with IEEE802.3af international standard switcher and other POE power supply devices. The maximum wattage of the transmitter or receiver is 10w.
4. Please note that our extender supports external 5V power supply for alternative. Please do not connect POE power supply and 5V power supply at the same time, choose one.

• Package Contents



HDMI EXTENDER
sender TX ×1pcs



IR blaster extension
cable x1pcs



HDMI EXTENDER
receiver Rx ×1pcs



IR receiver extension
cable x1pcs

Note : above accessory content is regular package for a kit. If buy HDMI extender TX or HDMI extender RX separately, the package contents would be different.

• Installation Requirements

1. HDMI source device(computer graphics card, DVD,PS3, HD monitoring equipment etc).
2. HDMI display device like SDTV, HDTV, projector with HDMI port.
3. Network cables : UTP/STP Cat5e/6 network cables, which follow the IEEE-568B standard.
Transmission length: CAT5 100m/ CAT5e/6/7 120m
4. POE powered device:
Support and compliant with IEEE802.3af international standard switcher and other POE power supply devices. The maximum wattage of the transmitter or receiver is 10w.

• Panel Description

1. HDMI EXTENDER TX (Sender)

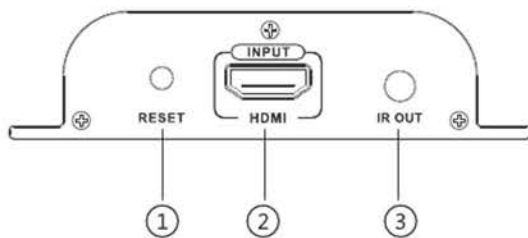

- ① Reset
- ② HDMI signal input
- ③ IR signal output to connect with blaster extension cable
- ④ Power input (DC5V)

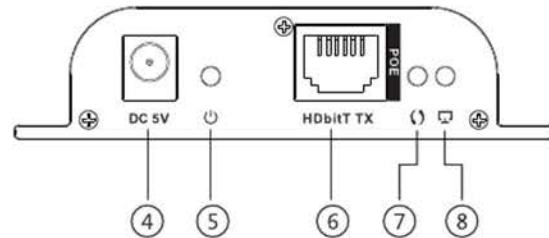

- ⑤ Power light
- ⑥ HDbitT signal output(POE Input)
- ⑦ Data transmission light
- ⑧ Network link light

2. HDMI EXTENDER RX(Receiver)

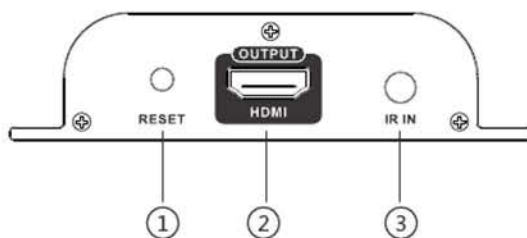

- ① Reset
- ② HDMI signal output
- ③ IR signal input to connect with IR receiver extension cable
- ④ Power input (DC5V)

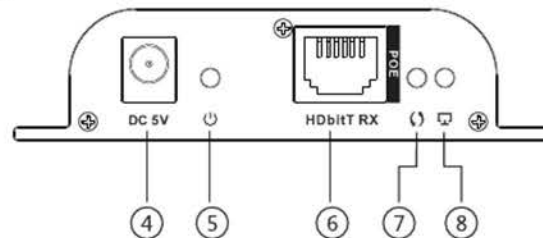

- ⑤ Power light
- ⑥ HDbitT signal input(POE Input)
- ⑦ Data transmission light
- ⑧ Network link light

• Installation Procedures

1. How to make a Cat5e/6 network cable

Follow the standard of IEEE-568B:

- | | | |
|----------------|--------------|---------------|
| 1-Orange/white | 4-Blue | 7-Brown/white |
| 2-Orange | 5-Blue/white | 8-Brown |
| 3-Green/white | 6-Green | |



2. Connections

2.1 Point to Point connection: Up to 120 meters transmission distance over single CAT6 (High quality cable can reach 150 meters) .

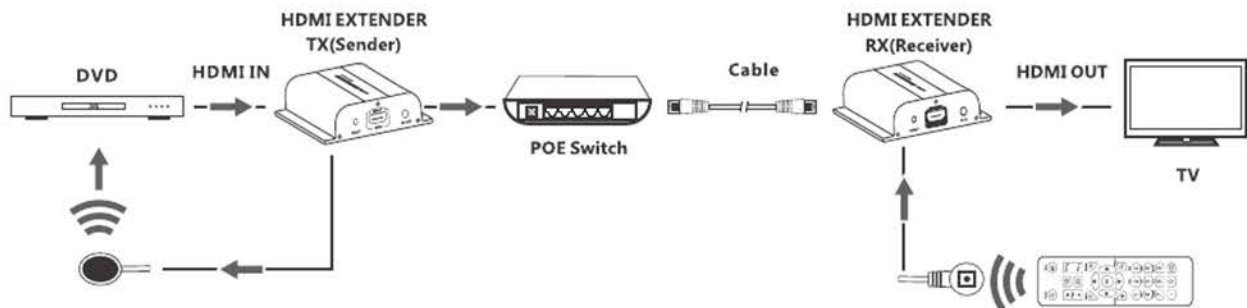

2.2 Router Connection: By using network router/repeater, realize unlimited extension.

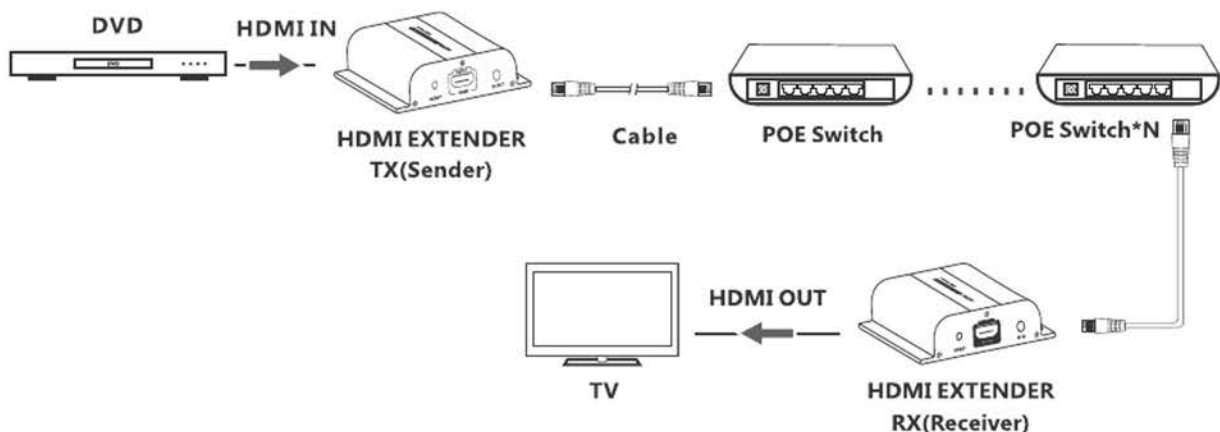

2.3 One-to-many Connection: By using network router/switch , one sender to several receivers, realize extender & splitter function.

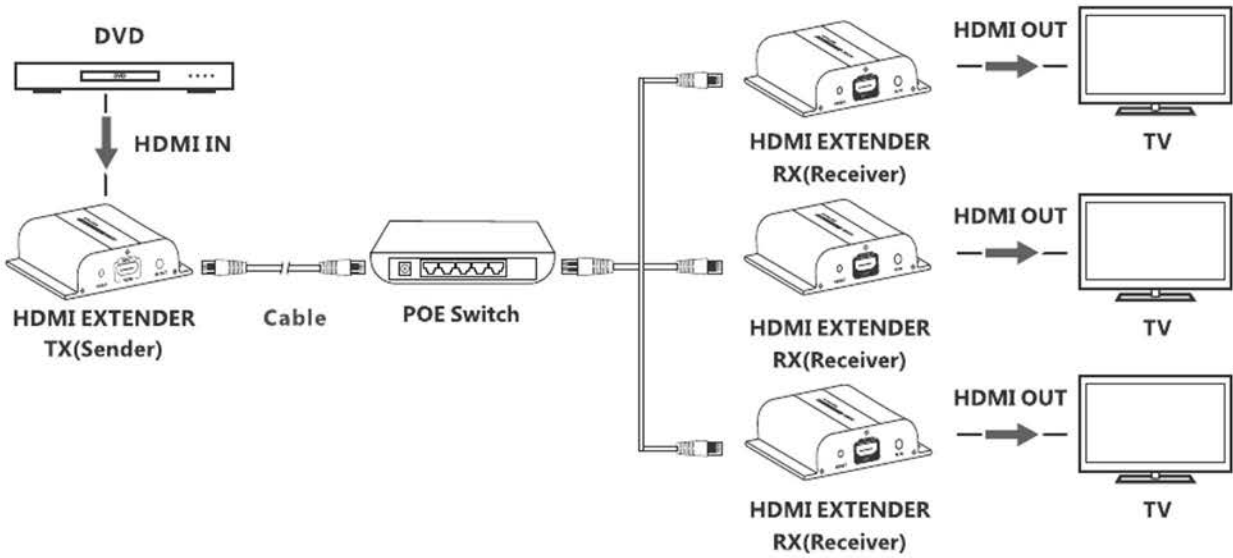

Note: Gigabit (1000Mbps) switcher is recommended in LAN transmission.

2.4 Many-to-many Connection: Using a managed network switch, several senders to several receivers provide greater versatility.

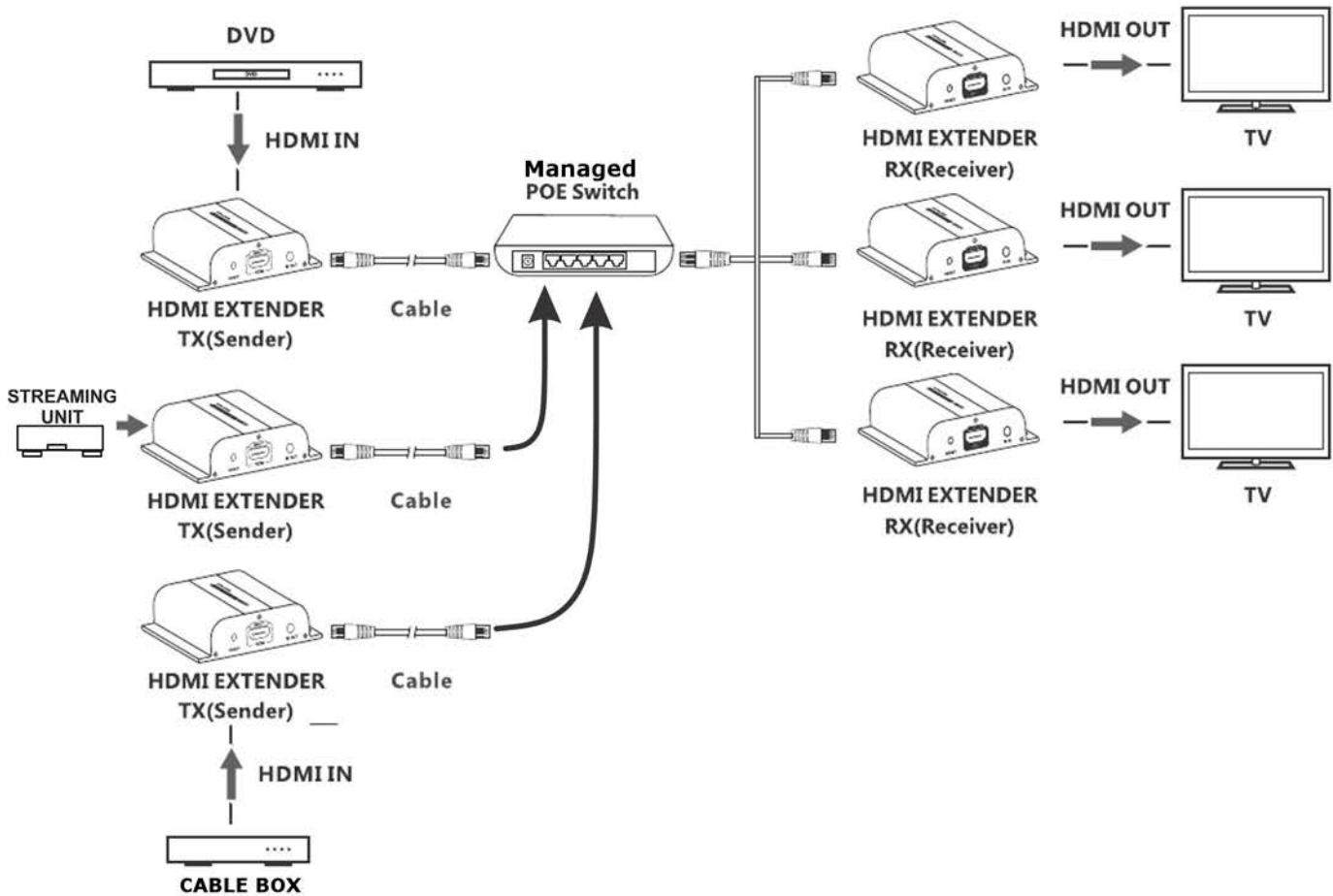

3. IR User Guide

- 1) IR blaster extension cable should plug-in the IR-out port of TX (Sender) of HDMI extender, and the IR receiver extension cable should plug-in the IR-out port of the RX (Receiver) of HDMI extender.
- 2) The emitter of IR blaster should as close as possible to the IR receiver of the signal source device.
- 3) Using the IR remote controller of the signal source device towards the IR receiver (connected to the RX of HDMI extender), to remote control source media playback.

• FAQ

Q : TV display "Waiting for connection" on the right corner?

A : Please check if the power supply of TX (Sender) and switcher (if used) is connected, and make sure connecting cable is firmly.

Q : TV display "Please check the TX input signal" ?

A : 1) Please check if there is a HDMI signal input of TX.

2) Try to connect the signal source directly to display device to see if there is signal output from source device or change the signal source, HDMI cable and try again.

Q : Display not fluent, not stable?

A : 1) Please check the cable length between the TX to switch, the switch to the RX and the connection between each level is within the required range.

2) Press the "reset" button on the TX/RX front panel, reset and reconnect.

• Specification

Items	Specifications
HDMI Signal	Compatible with HDCP
transport protocol	HDBiT
Support resolutions	480i@60Hz, 480p@60Hz, 576i@50Hz, 576p@50Hz, 720p@50/60Hz, 1080i@50/60Hz, 1080p@50/60Hz
Network Cable	UTP/STP Cat5/5e/6
Transmission distance	Up to 120 meters transmission distance for 1080p 60Hz Full HD over single CAT6
IR signal	Supports 20~60KHz IR devices
Working Temperature	0°C ~ 60°C
Power Supply	DC5V/1A (adapter not included)
Power Consumption	TX: 3.5W; RX: 3W
Dimensions	105(L) x 94.5(W) x 23.8(H)mm *2PCS
POE Input	Support IEEE802.3af (Input power 10W)
Weight	TX: 245g RX: 242g
Color	Black