THOR Fiber

H-HDSDI-DVBS2 Encoder & Modulator

User's Manual



A Note From Thor About This Manual

Intended Audience

This user manual has been written to help people who have to use, integrate and to install the product. Some chapters require some prerequisite knowledge in electronics and especially in broadcast technologies and standards.

Disclaimer

No part of this document may be reproduced in any form without the written permission of Thor Broadcast.

The contents of this document are subject to revision without notice due to continued progress in methodology, design and manufacturing. Thor shall have no liability for any error or damage of any kind resulting from the use of this document.

Copy Warning

This document includes some confidential information. Its usage is limited to the owners of the product that it is relevant to. It cannot be copied, modified, or translated in another language without prior written authorization from Thor Broadcast.

DIRECTORY

DIRECTORY	- 1 -
CHAPTER 1 INTRODUCTION	- 1 -
1.1 OUTLINE	- 1 -
1.2 FEATURES	- 1 -
1.3 SPECIFICATIONS.....	2
1.4 PRINCIPLE CHART	3
1.5 FUNCTION PRINCIPLE	3
1.6 APPEARANCE AND DESCRIPTION	3
CHAPTER 2 INSTALLATION GUIDE	5
2.1 ACQUISITION CHECK	5
2.2 INSTALLATION PREPARATION	5
2.3 WIRE'S CONNECTION	6
2.4 SIGNAL CABLE CONNECTION	7
CHAPTER 3 OPERATION	8
3.1 MAIN INTERFACE.....	8
3.2 GENERAL SETTING	9
CHAPTER 4 NMS SETTING	15
4.1 LOGIN	15
4.2 PARAMETER CONFIGURATION	16
CHAPTER 5 TROUBLESHOOTING	25
CHAPTER 6 PACKING LIST	ERROR! BOOKMARK NOT DEFINED.

Chapter 1 Introduction

1.1 Outline

Thor DVB-S2 modulators are built to the highest standards and fully comply with the second generation standard for satellite modulation of digital video broadcast streams. This platform is able to ingest a single program or multi program transport stream in either ASI or IP (MPEG-TS UDP) format. The chassis modulates the entire transport stream, along with any secondary programs and closed caption PIDs. For the highest reliability applications, an additional 3 ASI program stream inputs are provided and constantly monitored for stream integrity. With all four inputs constantly monitored for faults in the bit stream; the modulator can intelligently switch from one input to another the second a fault is detected. This allows a constant error free output to the DVB-S2 carrier. The processor recovers quickly enough to prevent even a single dropped frame in the output stream.

1.2 Features

- 1 SDI and 1 ASI Input
- HD H.264 format encoding
- HD and SD video resolution
- 216Mbps ASI input
- DVB-S/S2 RF output and ASI output
- DVB-S, DVB-S2 QPSK and DVB-S2 8PSK modulation mode
- Output Frequency: 950-2150MHz
- Symbol Rate: 0.05-20Msps
- Support BISS function
- Support Web NMS and front panel LCD & keyboard control
- Upgrade device through web NMS

1.3 Specifications

Input

Interface 1 SDI Input, 1 ASI Input

Sample rate 48KHz

Bit rate 64kbps, 96kbps, 128kbps, 192kbps, 256kbps, 320kbps

SDI Encoder Card

Video

Encoding H.264/AVC High Profile Level 4.0 (HD)
H.264/AVC High Profile Level 3.0 (SD)

Input 1* SDI

Resolution 1920*1080_60P, 1920*1080_50P,
1920*1080_60i, 1920*1080_50i,
1280*720_60p, 1280*720_50P
720*480_60i, 720*576_50i

Audio

Encoding MPEG1 Layer II(1*Stereo or 2*mono)

Sample rate 48KHz

Bit rate 64kbps, 96kbps, 128kbps, 192kbps, 256kbps, 320kbps

CVBS Encoder Card (optional)

Video

Encoding MPEG-2 MP@ML(4:2:0)

Input 1* CVBS

Resolution 720*576(PAL), 720*480(NTSC)

Audio

Encoding MPEG1 Layer II(1*Stereo or 2*mono)

Output

DVB-S/S2 RF output and ASI output

Modulation Mode

DVB-S QPSK: FEC 1/2,2/3,3/4,5/6,7/8

DVB-S2 QPSK:FEC 1/2,3/5,2/3,3/4,4/5,5/6,8/9,9/10

DVB-S2 8PSK FEC 3/5,2/3,3/4,5/6,8/9,9/10

RF output 950.00-2150.00 MHz, step 10Khz

Symbol rate 0.05-20.0Mbps

Output level adjustable -16db-0, maximum output level≥-8dbm

System function

LCD/keyboard operation, NMS support,

Ethernet software upgrade

General

Demission (W*L*H) 230mm×180mm×44mm

Temperature 0~45°C (operation), -20~80°C (storage)

Weight 3kgs

Power Supply DC 12V

Consumption 17.6W

1.4 Principle Chart

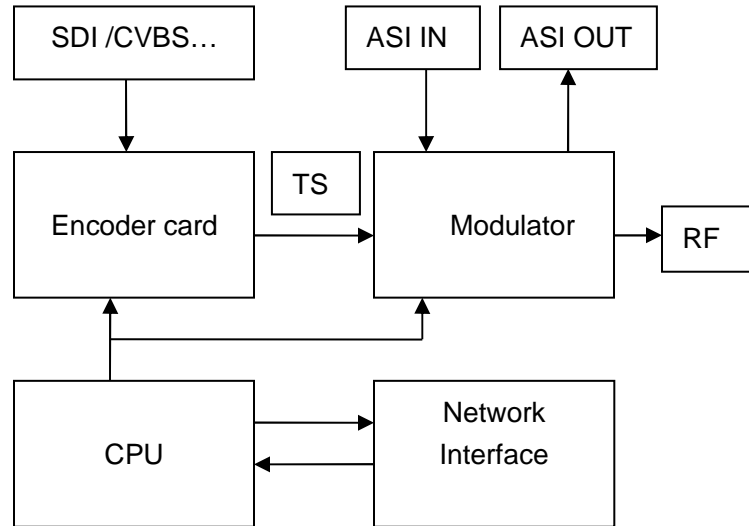

1.5 Functionality

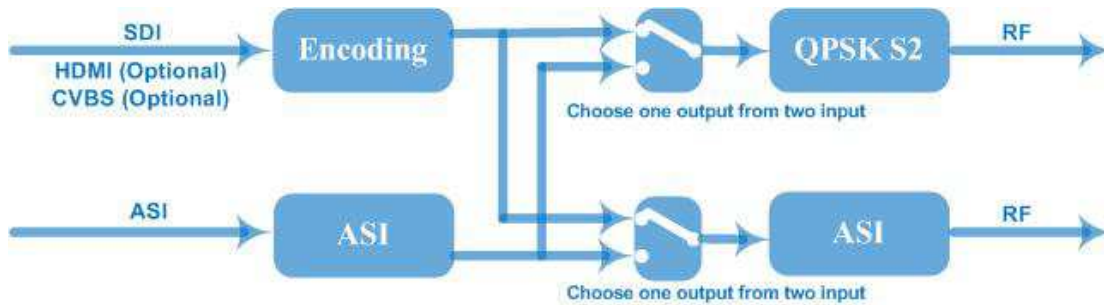

1.6 Appearance and Description

Front Panel Illustration

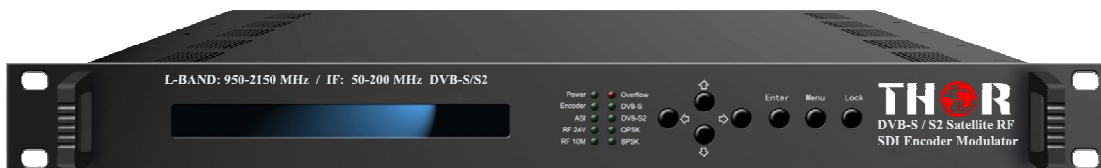

1

2

3

4

5

Chapter 2 Installation Guide

2.1 What's in the Box

When you first receive your new DVB-S2 Encoder Modulator, please check to make sure everything is included. If any pieces are missing please contact Thor Fiber immediately.

- H-HDSDI-DVBS2 HD Encoder Modulator
- User's Manual
- SDI Cable
- DC 12V Power Adapter

2.2 Installation Preparation

When you install the device, please follow the steps below:

- Check the device for any damage during transportation
- Prepare the environment for installation, easy access to rack
- Connect Internet cable
- Connect signal cables

2.2.1 Device's Installation Flow Chart Illustrated as following:

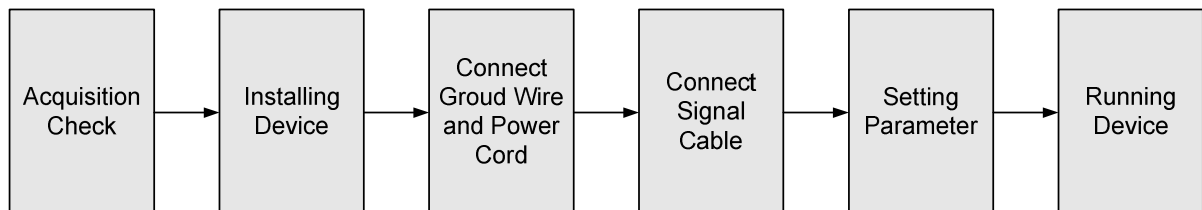

2.2.2 Environment Requirement

Item	Requirement
Machine Hall Space	When user installs machine on rack, the distance between 2 rows of machine frames should be 1.2~1.5m and the distance against wall should be no less than 0.8m.
Machine Hall Floor	Electric Isolation, Dust Free Volume resistivity of ground anti-static material: $1 \times 10^7 \sim 1 \times 10^{10} \Omega$, Grounding current limiting resistance: $1 \text{M}\Omega$ (Floor bearing should be greater than 450Kg/m^2)
Environment Temperature	$5 \sim 40^\circ \text{C}$ (sustainable), $0 \sim 45^\circ \text{C}$ (short time), installing air-conditioning is recommended
Relative Humidity	20%~80% sustainable 10%~90% short time
Pressure	86~105KPa
Door & Window	Make sure your installation area is free from any weather hazards
Wall	Isolated Tech or Rack Room
Fire Protection	Fire alarm system and extinguisher
Power	Device power requires AC $110 \text{V} \pm 10\%$, 50/60Hz or AC $220 \text{V} \pm 10\%$, 50/60Hz. Please carefully check before running.

2.3 Wire's Connection

➤ Connecting Power Cord

Insert one end into power supply socket, then insert the other end to DC power.

Caution:

Before connecting power cord to H-HDSI-DVBS2 HD Encoder & Modulator, user should set the power switch to "OFF".

2.4 Signal Cables

Please have these extra necessities available during installation.

2.4.1 ASI cable illustration:



2.4.2 Network cable illustration:



2.4.3 SDI cable illustration:



Chapter 3 Operation

The front panel of the H-1SDI-DVBS2 has an easy interface for manual operation of the unit. For easier and more manageable access please connect an RJ45 ethernet cable to the data port in the back to allow for the unit to be accessed by IP using the built in NMS GUI.

Keyboard Function Description:

MENU: Cancel current entered value, resume previous setting; Return to previous menu.

ENTER: Activate the parameters which need modification, or confirm the change after modification.

LEFT/RIGHT: Choose and set the parameters.

UP/DOWN: Modify activated parameter or paging up/down when parameter is inactivated.

LOCK: Locking the screen / canceling the lock state. After pressing lock key, the system will question the you to save present setting or not. If not, the LCD will display the current configuration state.

3.1 Main Interface

Switch on the encoder modulator, the LCD will display the start state and the main menu as below:

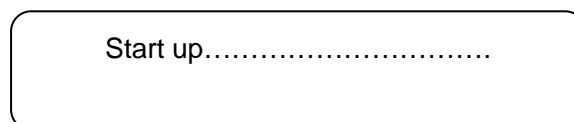

- ▶ 1 Alarm Status
- 2 Encode Setting
- 3 Modulate Setting
- 4 BISS Modulate
- 5 Network Setting
- 6 Saving Config
- 7 Loading Config
- 8 Version

3.2 General Setting

From here you can establish all necessary configurations and modifications to adjust the unit work properly in your infrastructure.

3.2.1 Alarm Status

Setting the triangle to point at menu 1, enter into this menu by pressing “Enter”.

If the device is working normally, it indicates No Warning as below:

Alarm Status
No Warning

The alarm indicator will turn on if there is no A/V signals input; or if there is a TS bit rate overflows.

Alarm Status
TS overflow

3.2.2 Encode Settings

Similarly, enter this menu to modify parameters of video bit rate and audio bit rate.

▶ Video Bit Rate
Audio Bit Rate

Enter sub-menu Video Bit Rate to adjust the bit rate by pressing right/left and up/down key and to confirm by pressing Lock key:

Video Bit Rate
08.000Mbps

Audio Bit Rate can be selected similarly (bit rate range: 64 /96 /128 /192 /256 /320 Kbps):

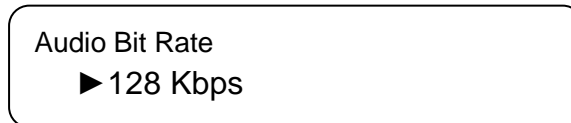

3.2.3 Modulate Setting

Enter this menu (3) to set the parameters of modulation:

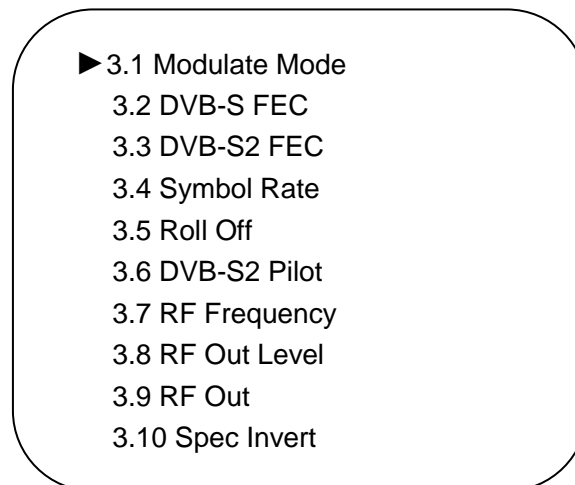

Modulate Mode: Select one of the following 3 modes: DVB-S, DVB-S2-QPSK and DVB-S2-8PSK through UP/DOWN key and confirm the setting by pressing Enter.

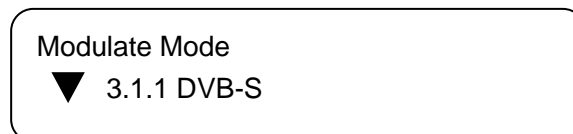

DVB-S FEC: Select one DVB-S FEC from 1/2, 2/3, 3/4, 5/6 and 7/8 by pressing RIGHT/LEFT key.

NOTE: Modulate Mode 3.1.1 DVB-S must be selected under menu 3.1, then it will operational.

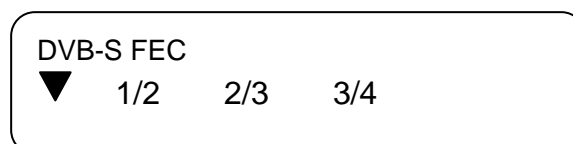

DVB-S FEC: Select one DVB-S2 FEC from QPSK1/2, QPSK3/5...and

QPSK9/10 by pressing RIGHT/LEFT key.

NOTE: Modulate Mode 3.1.2 DVB-S2-QPSK or 3.1.3 DVB-S2-8PSK must be selected under menu 3.1

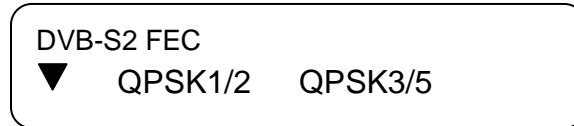

Symbol Rate: enter menu 3.4 to modify symbol rate (adjustable range: 0.050~20.000Mbps) by pressing right/left and up/down key and to confirm by pressing Lock key

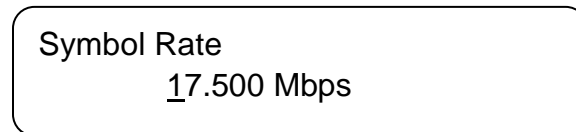

Roll Off: enter menu 3.5 to select roll-off shown as below by pressing right/left key and to confirm by pressing Lock key. Different Roll Off has different effects on the max input bit rate.

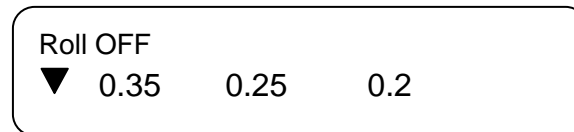

DVB-S2 Pilot: The DVB-S2 Pilot can be switched on or off through this menu.

NOTE: Modulate Mode 3.1.2 DVB-S2-QPSK or 3.1.3 DVB-S2-8PSK must be selected under menu 3.1, then it can be workable.

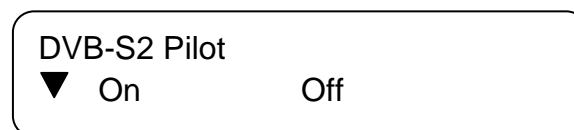

RF Frequency: The RF output frequency range is from 950 to 2150MHz with 1K stepping. After entering the RF frequency setting submenu, users the can press LEFT, RIGHT, UP, and DOWN buttons to adjust the frequency and confirm by pressing ENTER button. Remember to press LOCK and Save

RF frequency
2000.000 MHz

RF out level: The RF attenuation range is from -16db-0, maximum output level \geq -8dbm with 0.1db step. After entering this setting submenu, user can shift UP/DOWN/LEFT/RIGHT key to set the output level and press ENTER to confirm.

RF Out Level
-00.0db

RF out: The RF out-mode can be selected under this menu: The modes contain: single tone, modulation, test lation, and off lation.

RF Out
▼ Single tone

Spec Invert: Switch to the Spec Invert mode between Normal and Invert under this menu.

Spec Invert
▶ Normal Invert

3.2.4 BISS Modulate

User can press “Enter” key to enter into below menu of t BISS Modulate.

▶ 4.1 BISS Mode Set
4.2 Program Select
4.3 SW Data
4.4 Select ID
4.5 ESW Data
4.6 Input Data

BISS Mode Set: Choose between Mode 1 and Mode E. Detailed operation will

be explained in Chapter NMS Setting.

Program Select: Under this menu, users can modify the PID.

Program Select
PID: 0 x 0000

SW Data: When Mode 1 is selected, under this menu, users can input 12 characters from 0, 1, 2, 3, 4, 5, 6, 7, 8, 9, A, B, C, D, E, and F. More details please refer to Chapter NMS Setting.

SW Data ID
123456EBEFEE

Select ID: Under Mode E, select Burned Key option or not. For more details please refer to Chapter NMS Setting.

BISS Select ID
▼ Inject ID Buried ID

ESW Data & Input ID: Under Mode E, the BISS scrambler completes scrambling through **ESW** value and **Input ID**. Input the data and ID through the LCD buttons panel.

ESW Data
1111111111222222

Input ID
11111111112222

3.2.5 Network Setting

Press “Enter” key to enter into below menu of the network settings and modify the parameters under its corresponding submenus in the same way as was shown above.

- ▶ 5.1 IP Address
- 5.2 Subnet Mask
- 5.3 Gateway
- 5.4 MAC Address

Chapter 4 NMS Settings

H-HSDI-DVBS2 Encoder Modulator adopts web-based user interface, NMS GUI. Before operating, you should ensure that the computer's IP address is different from the DVB-S2's IP address; otherwise, it would cause an IP conflict.

4.1 Login

The default IP of this device is 192.168.0.136. We can change the IP from the front panel of the device. Then connect the pc to the device with RJ45 Cable, and use ping command to confirm these two are in same Network or not. If the PC IP address is 192.168.99.252, we change the Device IP to 192.168.99.196, then we need to use the Web browser to connect the device with our PC.

Put the IP address of the unit in the any internet browser and press Enter.

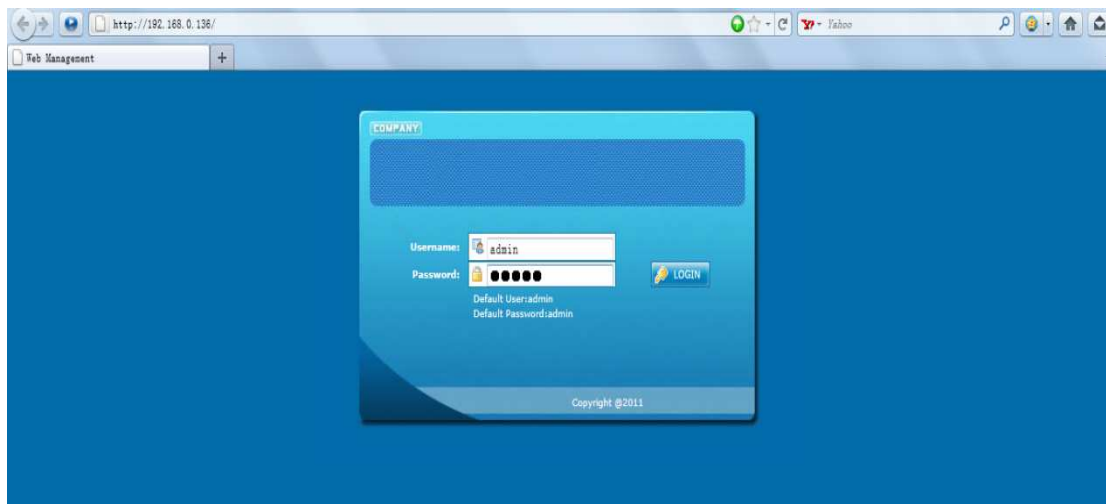

You should input the user name and password (The default Username and Password is '**admin**' and '**admin**' respectively) then click on 'Login' to enter the welcome interface which is shown as follows:

Web Management

- Welcome
- Parameter
 - Encoder
 - BISS
 - Modulator
 - Save/Restore
- System
 - Reboot
 - Firmware
 - Network
 - Password
 - Backup/Load

DVB-S2 Encoder Modulator

Version Information

Software Version:	1.22 Build Apr 26 2012
Hardware Version:	0.2
Web Version:	1.07

Status Information

Input

Interface:	SDI
Bitrate:	8.493 Mbps

Output

Maxout Bitrate:	17.305 Mbps
Current Out Bitrate:	8.477 Mbps
TS Overflow:	●
RF Frequency:	1000.000 MHz
RF Outlevel:	-0.5 dbm

It automatically indicates the signal source interface.

Green light indicates the TS is normal, otherwise, it turns to Red.

User can click any item here to enter the corresponding interface to check information or set the parameters.

4.2 Parameter Configuration

4.2.1 Encoder:

Click on 'Encoder', it displays the program's input information as below:

Web Management

- Welcome
- Parameter
 - Encoder
 - BISS
 - Modulator
 - Save/Restore
- System
 - Reboot
 - Firmware
 - Network
 - Password
 - Backup/Load

1CH H.264 HD SD Encoder Configuration (EN04)

Video BitRate	8.000 Mbps
Audio BitRate	128 Kbps
Program Name	TV-101
Service ID	0x101
PMT PID	0x100
Video PID	0x101
Audio PID	0x102
PCR PID	0x103

Video: ●

Video Format: 1920x1080 50i

Encoding: ●

Bitrate: 8.460 Mbps

Fom Version: 0.5

Green lights indicate it works normally, otherwise, they will turn to Red.

Help Default Apply

4.2.2 BISS:

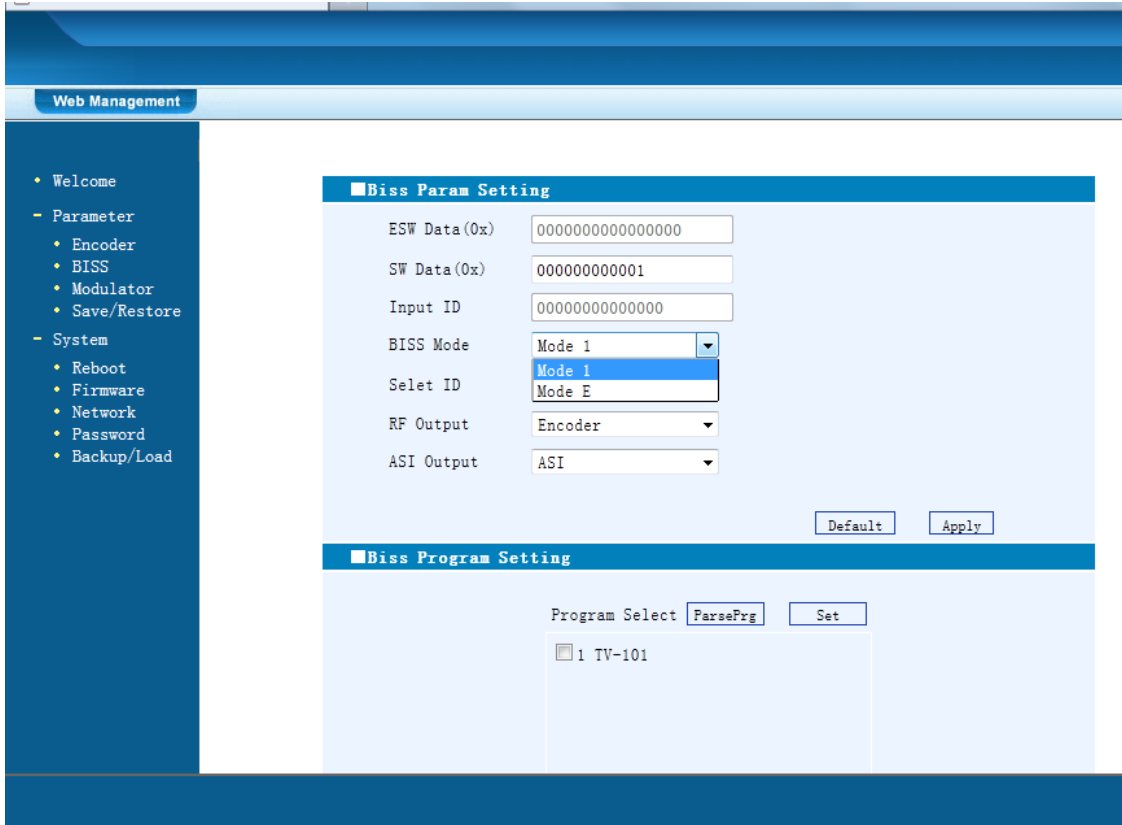

The screenshot shows the web management interface for THOR H-1SDI-DVB-S2. The main content area is titled "Web Management" and contains a navigation menu on the left and two configuration sections on the right.

Navigation Menu:

- Welcome
- Parameter
 - Encoder
 - BISS
 - Modulator
 - Save/Restore
- System
 - Reboot
 - Firmware
 - Network
 - Password
 - Backup/Load

BISS Param Setting:

ESW Data(0x)	<input type="text" value="0000000000000000"/>
SW Data(0x)	<input type="text" value="00000000000001"/>
Input ID	<input type="text" value="0000000000000000"/>
BISS Mode	<input type="text" value="Mode 1"/>
Selet ID	<input type="text" value="Mode 1"/>
RF Output	<input type="text" value="Encoder"/>
ASI Output	<input type="text" value="ASI"/>

Buttons:

BISS Program Setting:

Program Select

- 1 TV-101

The BISS scrambling function application needs to be matched with a BISS descrambler.

The BISS scrambling supports two modes: “Mode 1” and “Mode E”. Select one of the two modes in the drop down list.

4.2.2.1 Mode 1

Under Mode 1, the BISS scrambler applies scrambling by a fixed Control Word (CW), derived from a clear SW (Session Word). In Mode 1, a fixed 12-character SW is inserted in the scrambler. The 64-bit CW is derived from the SW according to DVB-CSA specification.

Select Mode 1 in the drop-down menu, and then input the scrambler key. The scrambler key consists of 12 characters from 0, 1, 2, 3, 4, 5, 6, 7, 8, 9, A, B, C, D, E, and F. The downside device descrambler key equals **SW Data** on the BISS scrambler side.

After inputting the scrambler key, press “Apply” to initial scrambling. A few

seconds later, the programs will be scrambled.

4.2.2.2 Mode E

Under Mode E, the BISS scrambler completes scrambling through **ESW Data** and **Input ID**. The ESW data equals Descrambler key on the downside device side, while the input ID equals Burned Key on IRD side.



The select ID has two options: Device and Input. If you choose Device, the Burned Key needs to be selected when descrambling, while you choose Input and set Input data, on the downside device side, users do not need to select Burned Key and input the Input data as SK.

Under Mode E, select Burned Key option. The device will calculate new data which works as a descrambling key. The new data is created by Descrambling Key (refers **ESW** on scrambler side) and Burned Key (Input or **Device** mode on the scrambler side). If you select Burned Key, it corresponds to the **Device** mode selected on scrambler side; while if Burned Key unselected, it corresponds to **Input** mode on scrambler side. The **Input** data is SK on the IRD. Input the SK in

the column as showed:



Mode E (Burned Key option unselected)

After selecting Mode E and Burned Key unselected, Input the 16 figure Descrambler Key and 14 characters SK (the SK data refers to the **Input Data** on scrambler side). Users should choose the characters from 0, 1, 2, 3, 4, 5, 6, 7, 8, 9, A, B, C, D, E, and F. Lastly users press “Set” to initial descrambling. A few seconds later, the programs will be descrambled.

Note: Under this mode, after inputting the Descrambler Key and SK, it will work out new data, which can be seen as the SW in Mode 1. The new data resulted from Descrambler Key and SK implements descrambling function.

Mode E (Burned Key option selected)

After selecting Mode E and Burned Key, Input the 16 figure Descrambler Key (named ESW on scrambler side). Choose characters from 0, 1, 2, 3, 4, 5, 6, 7, 8, and 9, A, B, C, D, E, and F. Under this mode, SK cannot be input in the column, as the data which works with ESW has been embedded inside the device after users select Burned Key (which refers that users choose **Device** mode on the scrambler side). Lastly press “Set” to initial descrambling. A few seconds later, the programs will be descrambled.

Note: The Burned Key is embedded in the device and it is solely controlled by the device supplier.

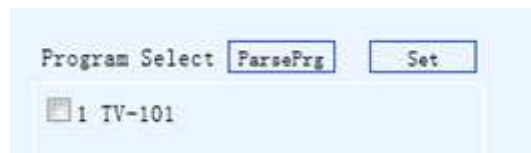

Click Parse Prg to view the input programs and modify the program names as their requirement. If you need to scramble the programs, mark the corresponding boxes in front of the programs with and click Set to activate the setting.

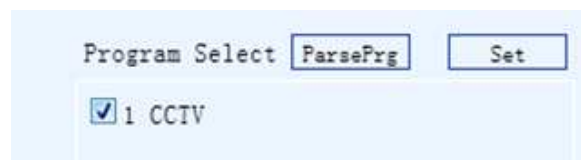

4.2.3 Modulator

Click Modulator on the left column and enter into the Modulate interface. For more details please refer to 3.2.3 in this manual.

web management

- Welcome
- Parameter
 - Encoder
 - BISS
 - Modulator
 - Save/Restore
- System
 - Reboot
 - Firmware
 - Network
 - Password
 - Backup/Load

Modulator Configuration

Modulation Mode	DVB-S2_QPSK	3 modes (DVB-S, DVB-S2-QPSK and DVB-S2-8PSK) to select
DVB-S FEC	1/2	Selectable when mode DVB-S is selected.
DVB-S2 FEC	QPSK 1/2	Selectable when mode DVB-S2-QPSK or DVB-S2-8PSK is selected.
Symbol Rate	17.500 Msp/s	(0.050 - 20.000 Msp/s)
Roll Off	0.35	
DVB-S2 Pilot	OFF	Selectable when mode DVB-S2-QPSK or DVB-S2-8PSK is selected.
RF Frequency	1000.00 MHz	(950.000 - 2150.000 MHz)
RF Outlevel	-0.5 db	
RF Out	single tone	
RF 10MCLK Enable	OFF	
Spec Invert	normal	
Max input bitrate:	17.305 Mbps	
Valid bitrate:	8.473 Mbps	

Default Apply

Modulation mode	DVB-S	it supports DVB-S, DVB-S2 QPSK and DVB-S2 8PSK three modes
	DVB-S2 QPSK	
	DVB-S2 8PSK	
DVB-S FEC	1/2, 2/3, 3/4, 5/6, 7/8	under DVB-S mode, it supports FEC 1/2, 2/3, 3/4, 5/6, 7/8
DVB-S2 FEC	1/2, 3/5, 2/3, 3/4, 5/6, 8/9, 9/10;	under DVB-S2 QPSK mode, it supports FEC 1/2, 3/5, 2/3, 3/4, 5/6, 8/9, 9/10; Under DVB-S2 8PSK mode, it supports FEC 3/5, 2/3, 3/4, 5/6, 8/9, 9/10
Symbol rate	the output range of symbol rate is 0.050-20.000Msp/s	
Roll off	0.25/0.3/0.35 selecting	
DVB-S2 pilot	DVB-S2 pilot ON/OFF selecting	
RF frequency	RF frequency is ranged from 950.00-2150.00MHz	
RF out level	output level ranges from -16db-0, maximum output level≥-8dbm with 0.1db step	
RF out	The modes contain: single tone, modulation, test lation, and off lation.	
RF 10MCLK Enable	RF 10MCLK ON/OFF selecting	
Spec Invert	User can switch the Spec Invert mode between Normal and Invert under this menu.	

4.2.4 Save/Restore

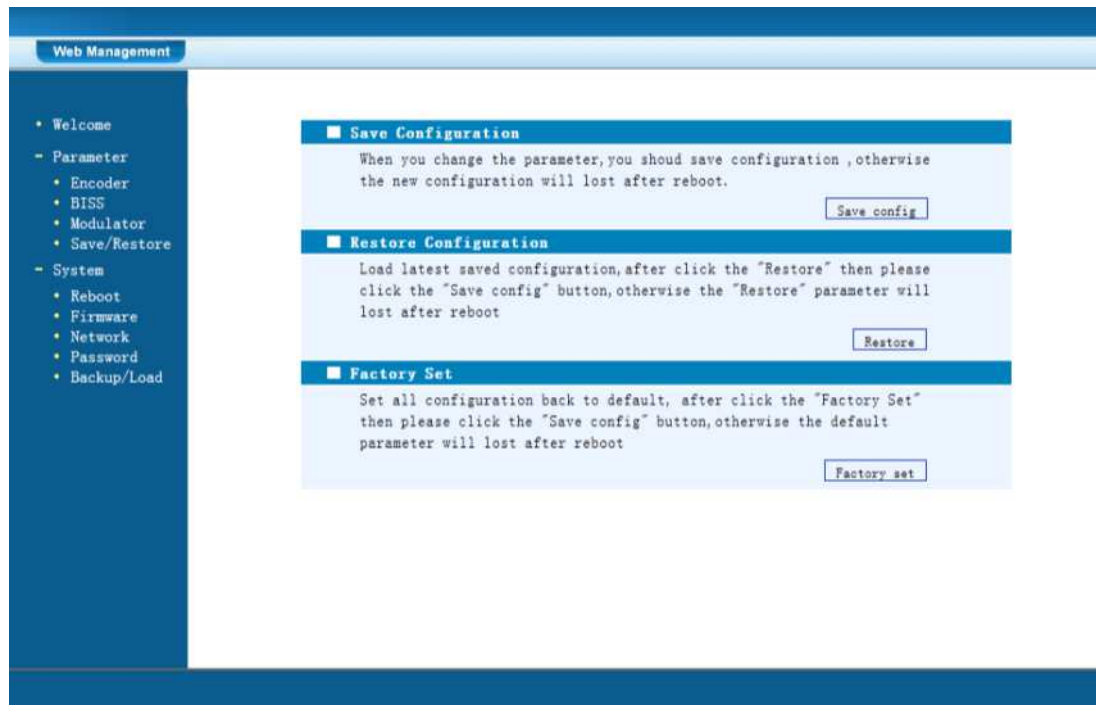

When you click on 'Save/Restore' from the menu, it will display the screen as shown below. Here we can save the configuration permanently to the device. Click on 'Save Configuration', to store the data permanently to the device.

By using 'Restore Configuration' we can restore the latest saving configuration to the device.

By using 'Factory Set,' user can set the default factory setting.

4.2.5 Reboot

When you click on 'Reboot' from the menu the screen will display as shown below. Here, when we click on 'Reboot' box it will restart the device automatically.



4.2.6 Firmware

When you click on 'Firmware' from the menu, it will display the screen as shown below. Here we can update the device by using the update file.

Click on 'Browse' to find the path of the devices update file for this device then click on 'Update' to update the device.

After updating the device we need to restart the device by using the Reboot option.



4.2.7 Network

When you click on 'Network', it will display the screen as shown below. It displays the network information of the Device. Here we can change the devices network configurations as needed.

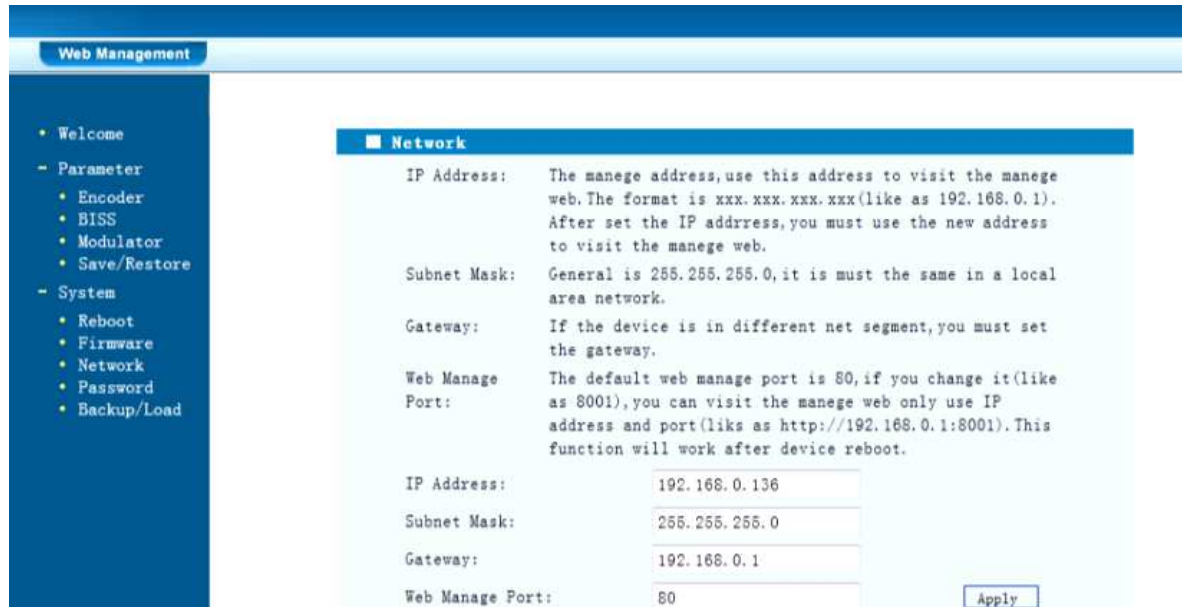

The screenshot shows the 'Web Management' interface with a sidebar menu on the left and a main content area. The sidebar menu includes 'Welcome', 'Parameter' (Encoder, BISS, Modulator, Save/Restore), and 'System' (Reboot, Firmware, Network, Password, Backup/Load). The main content area is titled 'Network' and contains the following text:

IP Address: The manage address, use this address to visit the manage web. The format is xxx.xxx.xxx.xxx (like as 192.168.0.1). After set the IP address, you must use the new address to visit the manage web.

Subnet Mask: General is 255.255.255.0, it is must the same in a local area network.

Gateway: If the device is in different net segment, you must set the gateway.

Web Manage Port: The default web manage port is 80, if you change it (like as 8001), you can visit the manage web only use IP address and port (like as http://192.168.0.1:8001). This function will work after device reboot.

Below the text are four input fields:

- IP Address: 192.168.0.136
- Subnet Mask: 255.255.255.0
- Gateway: 192.168.0.1
- Web Manage Port: 80

An 'Apply' button is located at the bottom right of the form.

4.2.8 Password:

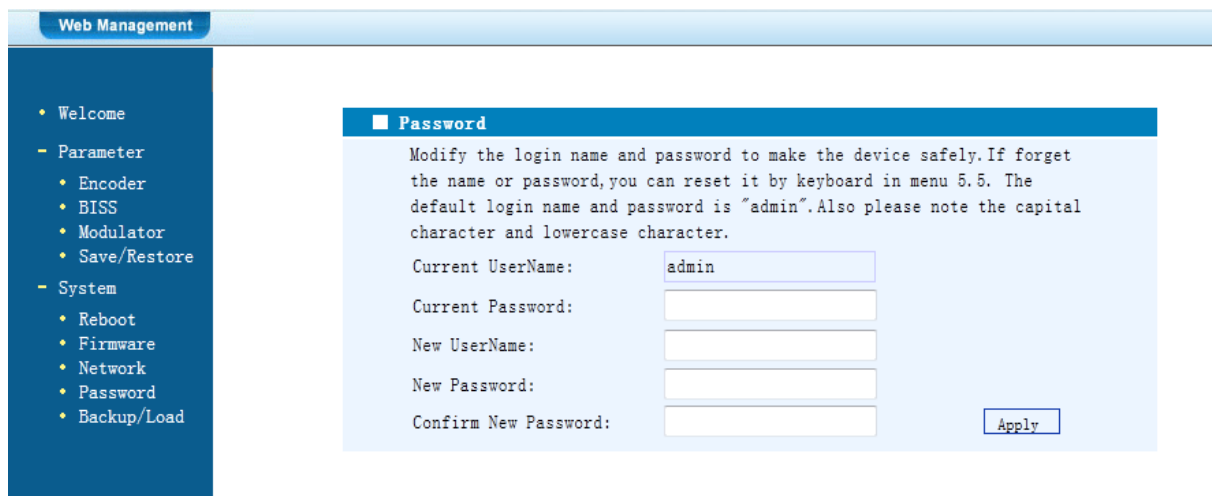

The screenshot shows the 'Web Management' interface with a sidebar menu on the left and a main content area. The sidebar menu includes 'Welcome', 'Parameter' (Encoder, BISS, Modulator, Save/Restore), and 'System' (Reboot, Firmware, Network, Password, Backup/Load). The main content area is titled 'Password' and contains the following text:

Modify the login name and password to make the device safely. If forget the name or password, you can reset it by keyboard in menu 5.5. The default login name and password is "admin". Also please note the capital character and lowercase character.

Below the text are four input fields:

- Current UserName: admin
- Current Password: [Empty]
- New UserName: [Empty]
- New Password: [Empty]
- Confirm New Password: [Empty]

An 'Apply' button is located at the bottom right of the form.

Change the password in this interface by putting the current username and password, then inserting a new username and password.

After adding the new parameters, click on 'Apply' to save the configuration.

4.2.9 Backup/Load

Click on 'Backup/Load' from the menu, it will display the screen as below.

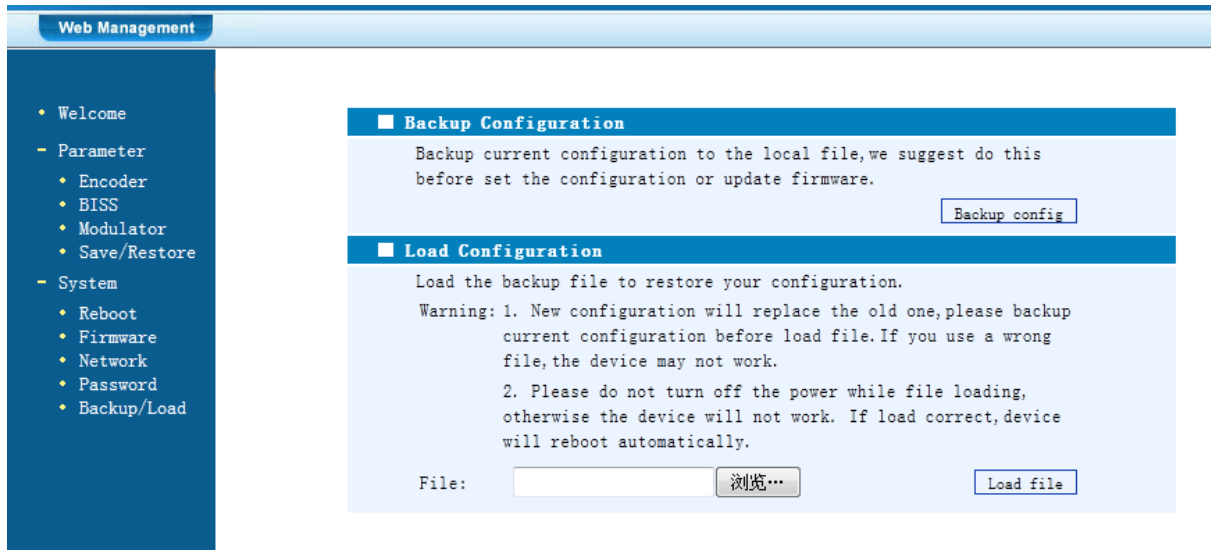

The screenshot shows the 'Web Management' interface. On the left is a navigation menu with the following items:

- Welcome
- Parameter
 - Encoder
 - BISS
 - Modulator
 - Save/Restore
- System
 - Reboot
 - Firmware
 - Network
 - Password
 - Backup/Load

The main content area is divided into two sections:

- Backup Configuration:** Contains the text "Backup current configuration to the local file, we suggest do this before set the configuration or update firmware." and a button labeled "Backup config".
- Load Configuration:** Contains the text "Load the backup file to restore your configuration." followed by a warning: "Warning: 1. New configuration will replace the old one, please backup current configuration before load file. If you use a wrong file, the device may not work. 2. Please do not turn off the power while file loading, otherwise the device will not work. If load correct, device will reboot automatically." Below this is a "File:" label, an empty text input field, a button labeled "浏览..." (Browse), and a button labeled "Load file".

Backup Configuration – Here we can back up the device configuration file to a folder by clicking on ‘Backup Config’.

Load Configuration – If we need to load a previously saved configuration to the device then we can click on ‘Browse’ and find the backup configuration file path. After selecting the file, click on ‘Load File’ to load the backup file to the device.

Chapter 5 Troubleshooting

THOR's ISO9001 quality assurance system has been approved by CQC organization. To guarantee the products' quality, reliability and stability all THOR products have been passed testing and inspection before heading to logistics. The testing and inspection scheme already covers all of the Optical, Electronic and Mechanical criteria which have been published by THOR. To prevent any potential hazard, please strictly follow the operation conditions.

Prevention Measure

- Installing the device at the place in which environment temperature between 0 to 45 °C
- Making sure good ventilation for the heat-sink on the rear panel and other heat-sink bores if necessary
- Checking the input AC within the power supply working range and the connection is correct before switching on device
- Checking the RF output level varies within tolerant range if it is necessary
- Checking all signal cables have been properly connected
- Frequently switching on/off device is prohibited; the interval between every switching on/off must greater than 10 seconds.

Conditions needed to unplug power cord

- Power cord or socket damaged.
- Any liquid gets into device.
- Anything that will cause a circuit short
- Damp environment
- Device suffered from physical damage
- Longtime idle processes
- After switching on and restoring to factory settings, device still cannot work properly.
- Maintenance needed