

datavideo

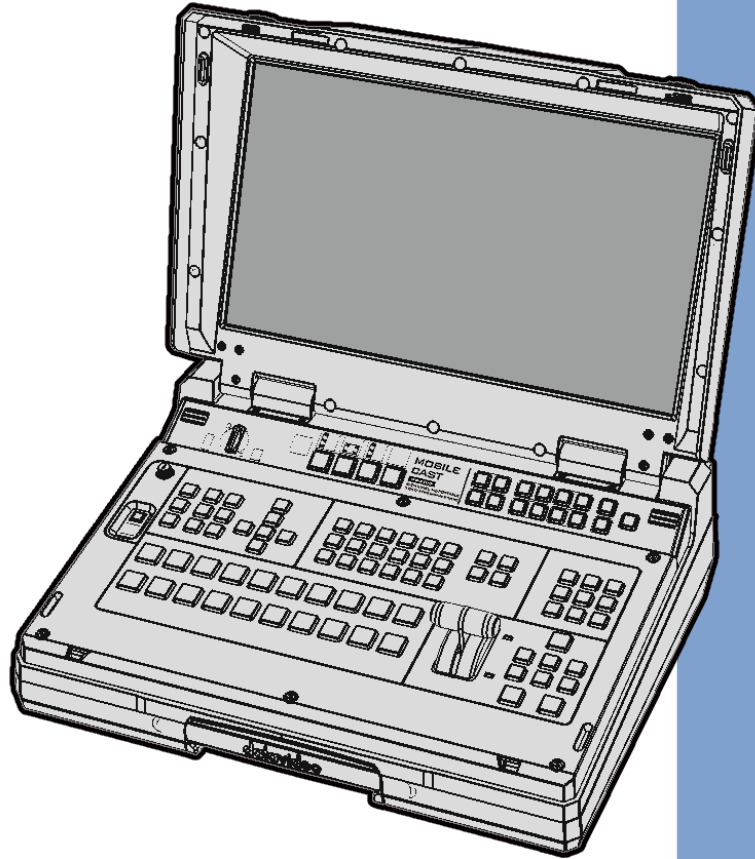

8-Channel HD Portable
Video Streaming Studio
HS-2600
Instruction Manual

www.datavideo.com

Table of Contents

FCC COMPLIANCE STATEMENT	8
WARNINGS AND PRECAUTIONS	8
WARRANTY	9
<i>STANDARD WARRANTY</i>	9
<i>THREE YEAR WARRANTY</i>	9
DISPOSAL	10
CHAPTER 1. INTRODUCTION	11
1.1 REAR PANEL OVERVIEW	12
1.2 CONTROL PANEL OVERVIEW.....	16
1.3 CONNECTING THE POWER SUPPLY	23
CHAPTER 2. PREPARATION	24
2.1 CONNECTING DEVICES.....	24
<i>Connecting the Video and Audio Input Devices</i>	24
<i>When linking via tally connection</i>	25
<i>Connecting the Video and Audio Output Devices</i>	25
2.2 NETWORK SETUP	26
<i>Static IP Configuration</i>	26
<i>DHCP Mode</i>	27
<i>DVIP</i>	28
2.3 MULTI VIEW	30
CHAPTER 3. SOFTWARE SETUP FOR SWITCHER	32
3.1 SWITCHER IMAGE IMPORT/EXPORT SOFTWARE.....	32
<i>Home</i>	33
<i>User</i>	33
<i>Still</i>	34
<i>Clip</i>	35
<i>Logo</i>	35
<i>Ani-Logo</i>	36
<i>Setup</i>	37
CHAPTER 4. OSD MENU	38
4.1 START	46
<i>Transition</i>	46
<i>Type</i>	46
<i>Wipe Effects</i>	47
<i>WIPE Border</i>	47
<i>Position</i>	47
<i>Matte</i>	47
4.2 KEYER	48
<i>Keyer</i>	48
<i>Keyer Control</i>	48
<i>Key Source</i>	49
<i>Fill Source</i>	50
<i>Invert</i>	50
<i>Mask</i>	50

4.3	CHROMA	51
	<i>Keyer</i>	51
	<i>Key Source</i>	51
	<i>Key Tie</i>	51
	<i>CK Setup</i>	53
	<i>Mask</i>	53
4.4	P-IN-P	53
	<i>Keyer</i>	54
	<i>Position</i>	54
	<i>Fine</i>	55
	<i>Border</i>	55
	<i>Shade Matte (Dual Color Border)</i>	55
	<i>Crop</i>	57
4.5	FLEX SRC	57
	<i>Flex Screen</i>	57
	<i>Keyer</i>	58
	<i>Flex Preset</i>	59
4.6	INPUTS	61
	<i>Input</i>	61
	<i>Proc Amp</i>	62
	<i>Audio</i>	62
	<i>Crosspoint</i>	62
	<i>Audio XPT</i>	62
4.7	OUTPUTS	62
	<i>Outputs</i>	63
	<i>Multiviewer</i>	63
	<i>Tally Mode</i>	64
	<i>GPI Out</i>	64
4.8	AUDIO	65
	<i>Audio</i>	65
	<i>PGM Audio</i>	65
	<i>Analog Out</i>	66
4.9	FILES	66
	<i>User Mems</i>	66
	Load Memory	66
	Save Memory	67
	<i>Still</i>	67
	Load Still	67
	Save Still	68
	Grab Still	68
	Loading still images	68
	<i>Clip</i>	69
	Load Clip	69
	Clip Settings	70
	Loading the existing Clip for Stinger Transition Effect	70
	<i>Logo</i>	70
	Load Logo	71
	Positioning	71
	<i>Ani Logo</i>	71
	Load Ani Logo	72
	Positioning	72
4.10	SETUP	72
	<i>Standard</i>	73

<i>Genlock</i>	73
<i>Menu Mode</i>	73
<i>Menu Preference</i>	73
<i>Auto Save</i>	74
<i>Factory Default</i>	74
<i>Language</i>	74
<i>Network</i>	74
<i>Software</i>	74
CHAPTER 5. BASIC OPERATION	76
5.1 VIDEO SWITCHING.....	76
<i>Program and Preview rows</i>	76
<i>Black and MATTE View</i>	76
<i>Flex Output</i>	77
<i>Still button</i>	77
5.2 TRANSITIONS.....	77
<i>AUTO Button</i>	77
<i>CUT Button</i>	77
<i>MIX Button</i>	78
<i>WIPE/DVE Button</i>	78
<i>WIPE/DVE Selection Pane</i>	78
<i>REV Button</i>	79
<i>Clip Button</i>	79
<i>Trans BG</i>	80
<i>Trans PVW</i>	80
<i>FTB Button</i>	80
<i>T-Bar</i>	80
5.3 MANAGING STILL PICTURES	80
<i>Grabbing & Saving a Still to Memory</i>	81
<i>Loading an existing Still from Memory</i>	81
<i>Deleting a saved Still from Memory</i>	82
<i>FS – Frame Store Button</i>	82
<i>Import Still Images from PC</i>	82
How to use	82
5.4 PERFORMING A STINGER TRANSITION.....	85
<i>Loading a Clip from Memory</i>	85
<i>Importing the Clip for Stinger Transition Effect from PC</i>	86
<i>How to Create the PNG Sequence for Stinger Transition Effect</i>	87
Adobe After Effects	87
Adobe Media Encoder CC.....	89
<i>Important things to note while creating Stinger Transition Effects</i>	92
5.5 ENABLING STILL LOGO.....	93
<i>Loading an existing Logo from Memory</i>	93
<i>Importing Still Logo from PC</i>	94
5.6 ENABLING LOGO ANIMATION	96
<i>Loading an existing Ani-Logo from Memory</i>	96
<i>Importing Animated Logo from PC</i>	96
CHAPTER 6. ADVANCED OPERATION	99
6.1 PICTURE-IN-PICTURE AND DOWNSTREAM KEY	100
<i>Picture-In-Picture</i>	100
Assigning a video source to a PIP window.....	101

Assigning a video source to a PIP window using shortcut keys	102
<i>Character Generator</i>	102
6.2 PLACING TEXT ON THE VIDEO USING LUMA KEY	103
6.3 INSERTION OF PEOPLE ONTO BACKGROUNDS (CHROMA KEY).....	105
6.4 DISPLAYING A VARIETY OF SOURCES AT THE SAME TIME.....	108
<i>Basic Flex™ Output (Four PIP Windows)</i>	108
Assigning a video source to a PIP window using shortcut keys	111
<i>Simultaneously Enabling up to Eight PIP Windows</i>	111
6.5 SHORTCUT KEYS TO ASSIGNING OUTPUT SOURCES	113
CHAPTER 7. MONITOR	115
7.1 MENU OPTIONS	115
<i>Picture</i>	117
Brightness.....	117
Contrast.....	117
Saturation.....	117
Tint	117
Sharpness	117
RGB Range.....	118
HDMI EDID.....	118
Color Space.....	118
Gamma.....	118
HDR	118
Back Light	118
Color Temperature	118
<i>Marker</i>	119
Center Marker	119
Center Marker Size	119
Aspect Marker	119
Safety Marker	119
Marker Color	120
Thickness	120
<i>Function</i>	120
Scan	120
Aspect.....	120
Overscan.....	121
Check Field	121
Zoom	122
False Color	122
False Color Table	123
<i>Audio</i>	123
Volume	123
Audio Out	123
<i>System</i>	124
Language	124
Color Bar.....	124
OSD Timer	124
OSD Transparency	124
OSD H Position	124
OSD V Position.....	124
Firmware Version	124
Reset.....	124
CHAPTER 8. VIDEO STREAMING AND RECORDING	125
8.1 STREAMING NETWORK CONNECTION AND DEVICE SEARCH.....	125

<i>DHCP</i>	125
<i>Static IP</i>	126
Static IP Address	126
8.2 WEB USER INTERFACE.....	126
<i>Status Pane</i>	129
<i>Information Pane</i>	130
<i>Encoder</i>	131
Streaming Encoder Settings	132
Recorder Settings	134
<i>Network</i>	135
DHCP Enable/Disable	135
RTC Settings.....	136
<i>System</i>	136
Device Name	136
Account and Password	136
Disk Format	136
8.3 VIDEO STREAMING GUIDES	137
<i>RTMP(S)</i>	137
Facebook	137
Youtube	140
<i>SRT</i>	143
Listener.....	143
Caller	144
8.4 PANEL BUTTONS	146
<i>Button and LED Behavior</i>	146
<i>MODE Button</i>	147
<i>FORMAT Button</i>	147
<i>BITRATE Button</i>	147
<i>START/STOP Button</i>	148
8.5 RESETTING LOGIN CREDENTIALS.....	148
CHAPTER 9. APPENDICES.....	149
APPENDIX 1 TALLY OUTPUTS	149
APPENDIX 2 GPI / GPO CONNECTIONS.....	151
APPENDIX 3 RS-232 SERIAL PORT PINOUT	152
APPENDIX 4 RECOMMENDED SD CARDS	153
APPENDIX 5 FIRMWARE UPDATE	155
APPENDIX 6 FREQUENTLY-ASKED QUESTIONS	156
APPENDIX 7 DIMENSIONS & WEIGHT	157
APPENDIX 8 SPECIFICATIONS.....	158
SERVICE AND SUPPORT.....	160

Disclaimer of Product & Services

The information offered in this instruction manual is intended as a guide only. At all times, Datavideo Technologies will try to give correct, complete and suitable information. However, Datavideo Technologies cannot exclude that some information in this manual, from time to time, may not be correct or may be incomplete. This manual may contain typing errors, omissions or incorrect information. Datavideo Technologies always recommend that you double check the information in this document for accuracy before making any purchase decision or using the product. Datavideo Technologies is not responsible for any omissions or errors, or for any subsequent loss or damage caused by using the information contained within this manual. Further advice on the content of this manual or on the product can be obtained by contacting your local Datavideo Office or dealer.

FCC Compliance Statement

This device complies with part 15 of the FCC rules. Operation is subject to the following two conditions:

- (1) This device may not cause harmful interference, and
- (2) This device must accept any interference received, including interference that may cause undesired operation.

Warnings and Precautions



1. Read all of these warnings and save them for later reference.
2. Follow all warnings and instructions marked on this unit.
3. Unplug this unit from the wall outlet before cleaning. Do not use liquid or aerosol cleaners. Use a damp cloth for cleaning.
4. Do not use this unit in or near water.
5. Do not place this unit on an unstable cart, stand, or table. The unit may fall, causing serious damage.
6. Slots and openings on the cabinet top, back, and bottom are provided for ventilation. To ensure safe and reliable operation of this unit, and to protect it from overheating, do not block or cover these openings. Do not place this unit on a bed, sofa, rug, or similar surface, as the ventilation openings on the bottom of the cabinet will be blocked. This unit should never be placed near or over a heat register or radiator. This unit should not be placed in a built-in installation unless proper ventilation is provided.
7. This product should only be operated from the type of power source indicated on the marking label of the AC adapter. If you are not sure of the type of power available, consult your Datavideo dealer or your local power company.
8. Do not allow anything to rest on the power cord. Do not locate this unit where the power cord will be walked on, rolled over, or otherwise stressed.
9. If an extension cord must be used with this unit, make sure that the total of the ampere ratings on the products plugged into the extension cord do not exceed the extension cord rating.
10. Make sure that the total amperes of all the units that are plugged into a single wall outlet do not exceed 15 amperes.
11. Never push objects of any kind into this unit through the cabinet ventilation slots, as they may touch dangerous voltage points or short out parts that could result in risk of fire or electric shock. Never spill liquid of any kind onto or into this unit.
12. Except as specifically explained elsewhere in this manual, do not attempt to service this product yourself. Opening or removing covers that are marked "Do Not Remove" may expose you to dangerous voltage points or other risks, and will void your warranty. Refer all service issues to qualified service personnel.
13. Unplug this product from the wall outlet and refer to qualified service personnel under the following conditions:
 - a. When the power cord is damaged or frayed;

- b. When liquid has spilled into the unit;
- c. When the product has been exposed to rain or water;
- d. When the product does not operate normally under normal operating conditions. Adjust only those controls that are covered by the operating instructions in this manual; improper adjustment of other controls may result in damage to the unit and may often require extensive work by a qualified technician to restore the unit to normal operation;
- e. When the product has been dropped or the cabinet has been damaged;
- f. When the product exhibits a distinct change in performance, indicating a need for service.

Warranty

Standard Warranty

- Datavideo equipment is guaranteed against any manufacturing defects for one year from the date of purchase.
- The original purchase invoice or other documentary evidence should be supplied at the time of any request for repair under warranty.
- The product warranty period begins on the purchase date. If the purchase date is unknown, the product warranty period begins on the thirtieth day after shipment from a Datavideo office.
- All non-Datavideo manufactured products (product without Datavideo logo) have only one year warranty from the date of purchase.
- Damage caused by accident, misuse, unauthorized repairs, sand, grit or water is not covered under warranty.
- Viruses and malware infections on the computer systems are not covered under warranty.
- Any errors that are caused by unauthorized third-party software installations, which are not required by our computer systems, are not covered under warranty.
- All mail or transportation costs including insurance are at the expense of the owner.
- All other claims of any nature are not covered.
- All accessories including headphones, cables, batteries, metal parts, housing, cable reel and consumable parts are not covered under warranty.
- Warranty only valid in the country or region of purchase.
- Your statutory rights are not affected.

Three Year Warranty

- All Datavideo products purchased after July 1st, 2017 qualify for a free two years extension to the standard warranty, providing the product is registered with Datavideo **within 30** days of purchase.



- Certain parts with limited lifetime expectancy such as LCD panels, DVD drives, Hard Drive, Solid State Drive, SD Card, USB Thumb Drive, Lighting, Non-PCIe Card and third party provided PC components are covered for 1 year.
- The three-year warranty must be registered on Datavideo's official website or with your local Datavideo office or one of its authorized distributors within 30 days of purchase.

Disposal

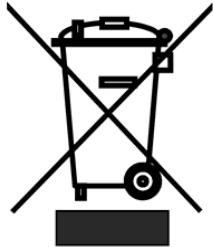

For EU Customers only - WEEE Marking

This symbol on the product or on its packaging indicates that this product must not be disposed of with your other household waste. Instead, it is your responsibility to dispose of your waste equipment by handing it over to a designated collection point for the recycling of waste electrical and electronic equipment. The separate collection and recycling of your waste equipment at the time of disposal will help to conserve natural resources and ensure that it is recycled in a manner that protects human health and the environment. For more information about where you can drop off your waste equipment for recycling, please contact your local city office, your household waste disposal service or the shop where you purchased the product.



CE Marking is the symbol as shown on the left of this page. The letters "CE" are the abbreviation of French phrase "Conformité Européene" which literally means "European Conformity". The term initially used was "EC Mark" and it was officially replaced by "CE Marking" in the Directive 93/68/EEC in 1993. "CE Marking" is now used in all EU official documents.

Chapter 1. Introduction

The HS-2600 is an HD 8-channel digital video switcher that supports full 1080p/60 (3G) high definition videos. It features 8 digital inputs, including 4 SDI and 4 HDMI inputs with embedded audio, as well as 3 SDI and 4 HDMI outputs for connecting HD recorders, external monitors, and other devices.

The HS-2600 also provides powerful and easy-to-use effects, including Chroma Key, Luma Key, DSK, PIP, DVE/wipe generator, still stores, and logo insertion.

Features

- FHD 1080P signals on input and output
- 8 live channels: 4x3G-SDI + 4xHDMI
- 7 outputs: 3 x 3G-SDI (Level A) + 4 x HDMI 1.4 (1 AUX assignable and 3 PGM only)
- Support 1080p SDI input Level A/B
- 2 x audio XLR (6.3mm) Combo Socket selectable between MIC and Line IN audio inputs
- 1 x stereo RCA audio input
- 1 x stereo RCA audio output
- Each output can be used as an AUX designated output signal
- 4 x Upstream Keyers and 2 x Downstream Keyers
- 4 x Picture-in-Picture
- Built-in CG title overlay system
- 2 Logo insertion (Animation logo, X/Y size)
- Any Input (1-8) can be used as a Frame store (Stills Store)
- Crosspoint assignment (XPT)
- Wipe, Mix, DVE, Cut and Stinger Transitions
- Tally output
- Analogue Gen-Lock supporting Black Burst and Tri Level cross reference

1.1 Rear Panel Overview

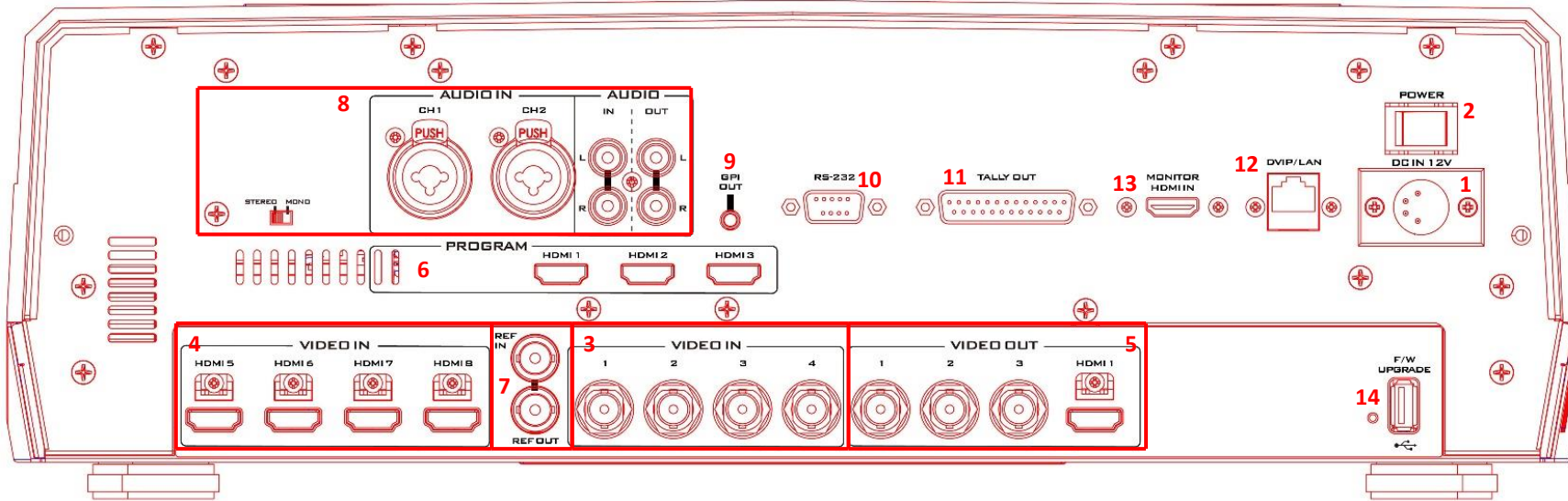

Power

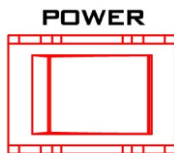
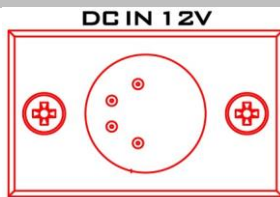

1. DC IN

Connect the supplied 12V PSU to this 4 PIN XLR socket

Pin 1 = GND (-)

Pin 2 = NC

Pin 3 = NC

Pin 4 = VCC (+)

2. Power Button

The power button starts and shuts down the machine.

Video Input

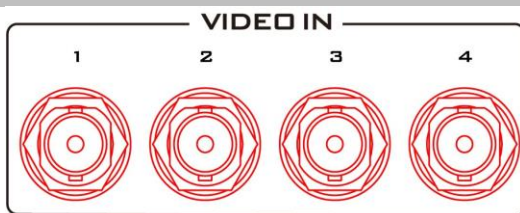

3. SDI Video Inputs 1 – 4

SDI video input channels 1 – 4.

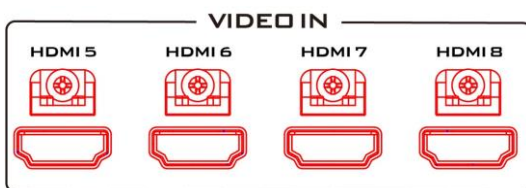

4. HDMI Video Inputs 5 – 8

SDI video input channels 5 – 8.

Video Output

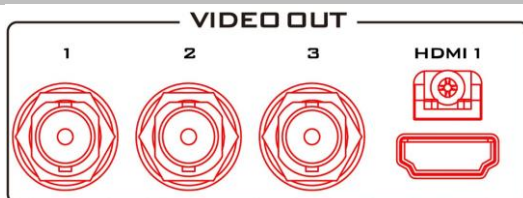

5. SDI Video Outputs

SDI 1, SDI 2 and HDMI 1 are user-defined video output ports. Each of these outputs has the option to be:

- Multiview
- Program
- Preview
- Program + DSK
- Clean Program
- Clean Preview
- Input 1 – 8
- Still 1/2
- Flex Src 1

Use the OSD menu to select your desired output and please note that SDI 3 is a Program Only video output port.



6. HDMI Video Outputs

Connect external monitors to display the program view video only.

SYNC I/O



7. REF IN/OUT

The HS-2600 can be synchronized with other studio equipment such as cameras. **REF IN** accepts Tri-level or Black Burst sync. **REF OUT** can be used to pass the sync signal to other studio equipment such as cameras or recorders.

See the section on [Genlock](#) for details.

8. Audio

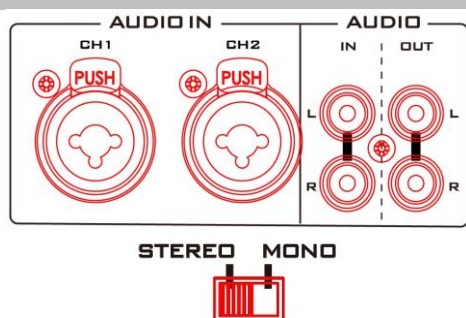

AUDIO OUT

Supports a stereo RCA output pair.

AUDIO IN

Supports two channels of the XLR combo sockets (MIC/LINE IN) for balanced audio input and a stereo RCA input pair. You can switch between stereo and mono for the input audio.

See [Section 4.8 Audio](#) for audio setup.

Control



9. GPI OUT

The [GPI socket](#) can be used for simple external control.

See [GPI OUT](#) for various settings and See [Appendix 2](#) for specifics about making your own GPI cable.

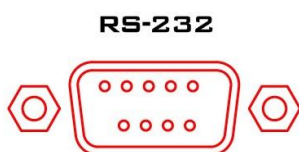

10. RS-232 REMOTE

In addition to the Ethernet port for remote control, you can also connect a custom keyboard controller to this port.

See [Appendix 3](#) for details or contact your local Datavideo distributors.

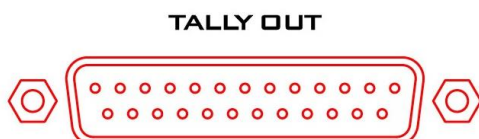

11. TALLY OUT

The HS-2600 Tally Output port provides bi-colour tally information to a number of other Datavideo products, such as the ITC-100 eight channel talkback system or the Datavideo TLM range of monitors.

See [Appendix 1](#) and [Section 4.7](#) for more details.

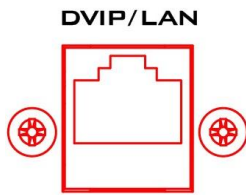

12. Ethernet Port

The DVIP port is designed for the user to access the switcher's settings as well as the streaming server. You can either use a static IP address to connect or connect with DHCP. See [Section 2.2 Network Setup](#) to set up your network for accessing the switcher's network settings and [Chapter 8](#) for streaming server setup.

Please note that the switcher uses a static IP address by default which is 192.168.100.101. You can use the reset hole next to the USB FW Upgrade port to restore the default IP address. Use a needle to push the reset hole then hold for about 5 to 10 seconds until the machine reboots itself to restore the switcher's default IP address.

For transmission distances over 100 meters, please use a CAT6A 23 AWG Ethernet cable or higher.

General



13. Monitor HDMI IN (External Video Input)

The HS-2600 provides a useful connection for confidence monitoring of HDMI sources on location.

Connect one external HDMI input source for monitoring the live show.



14. USB FW Upgrade Port

Connect the USB drive containing the switcher's latest firmware files to this port and start the firmware upgrade process on the OSD MENU.

See [Firmware Update](#) section for details.

1.2 Control Panel Overview

Perform video switching and other relevant controls on the **Control Panel**.

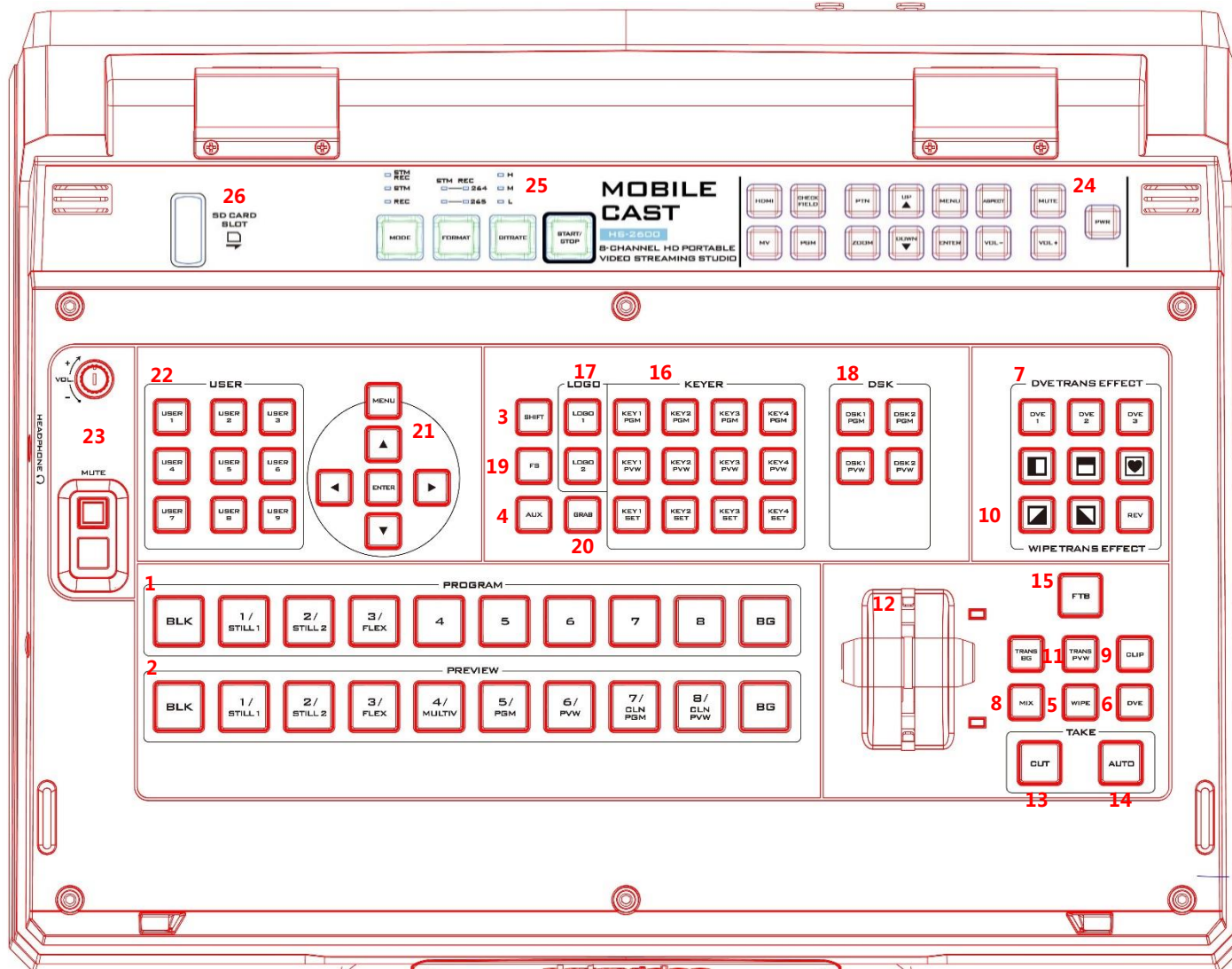

Video Switching

- 1. Program row** Selection of a program video source (see [Section 5.1 Video Switching](#) for detailed instructions).



- 2. Preview row** Selection of a preview video source (see [Section 5.1 Video Switching](#) for detailed instructions).

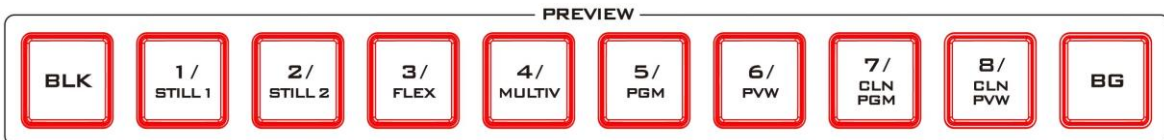

3. SHIFT Button

While pressing and holding down the **SHIFT** button, press the Channel 1/2/3 buttons to switch the Preview/Main Program view to still 1 picture, still 2 picture or **Flex™** output.

See [Flex Output](#) and [Still Button](#) for detailed instructions.



4. AUX Button

Press the AUX button to activate the Preview row for assigning a video source to an output channel.

See [6.5 Shortcut Keys for assigning Output Sources](#) for detailed instructions.

WIPE/DVE Transition Effects



5. WIPE Button

Press to enable WIPE transition effect (See the [WIPE/DVE Button](#) section for detailed instructions).



6. DVE Button

Press to enable animated transition effect (See the [WIPE/DVE Button](#) section for detailed instructions).

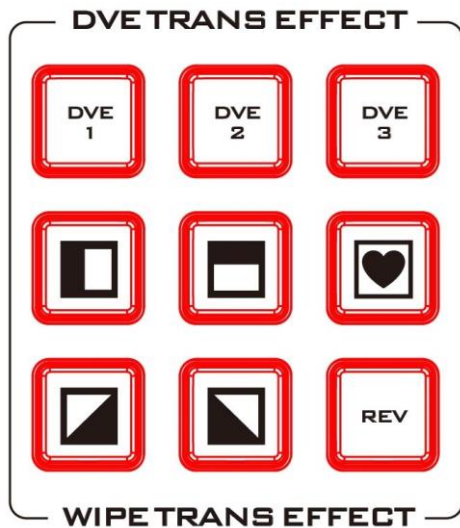

7. WIPE/DVE Selection Pane

There are 32 different 2D WIPE effects and 3 different 3D WIPE effects to choose from when using the HS-2600 switcher. To select a different WIPE transition, either select a WIPE style in the **TRANS EFFECT** area of the HS-2600 Control Panel or the **Start** Item of the OSD Menu. Before you make the selection, make sure the **TRANS BG** and **WIPE/DVE** buttons are enabled.

When the **REV** Button is **OFF** the selected WIPE or DVE transition will operate in its default direction only. When the **REV** Button is **ON** then the selected transition will operate in the reverse direction.

See the [WIPE/DVE Button](#) section for detailed instructions.

Transitions



8. MIX Button

Selection of MIX transition effect (See the [Mix Button](#) section for detailed instructions).



9. CLIP Button

Press to enable animated transition effect (See the [Clip Button](#) section for detailed instructions).



10. TRANS BG Button

Turning on the Trans BG button allows you to activate the MIX, WIPE or Stinger transition with the background image/video (See the [TRANS BG Button](#) section for detailed instructions).



11. TRANS PVW Button

Once enabled, you can then test the effect of a chosen **MIX**, **WIPE** or **Stinger** transition on the Preview Monitor (See the [TRANS PVW Button](#) section for detailed instructions).

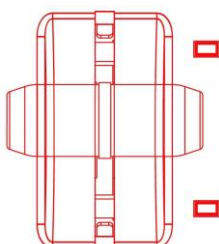

12. T-Bar (Manual Transition)

Move the T-Bar up or down to switch between Preview and Program videos (See the [T-Bar](#) section for detailed instructions).



13. CUT Button

A hard cut between video sources (See the [CUT Button](#) section for detailed instructions).



14. AUTO Transition

Press to trigger automatic transition (See the [AUTO Button](#) section for detailed instructions).



15. FTB Button (Fade to Black)

Fades the program view to black once pressed (See the [FTB Button](#) section for detailed instructions).

Keys

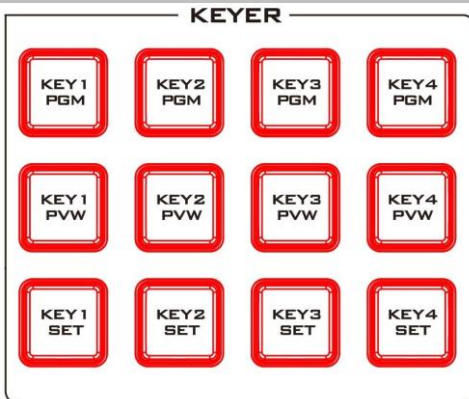

16. Keyer Selection

Enabling the pre-assigned keyers (Chroma, Luma, Linear, DSK and PIP) on Program and Preview views.

Note: See [Chapter 6 Advanced Operation](#) for detailed descriptions of various keyer functions.

Logo

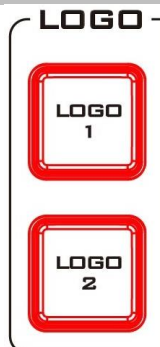

17. Logo 1 & 2

Logo insertion on preview and program outputs once enabled.

Note: Logos will not be transitioned as the CUT or AUTO button is pressed, nor will it be transitioned as the T-Bar is pushed. See [Section 5.5 Enabling Still Logo](#) and [Section 5.6 Enabling Logo Animation](#) for detailed descriptions of the logo function.

DSK

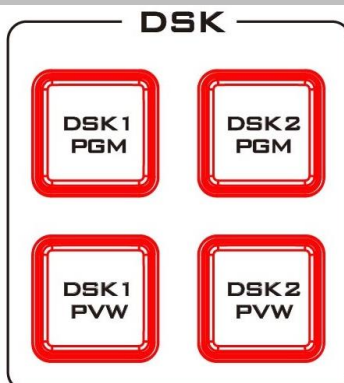

18. DSK Selection

Enabling DSK on preview and program outputs.

Note: See [Chapter 6 Advanced Operation](#) for detailed descriptions of the DSK function.

Still Picture Grab and Save



19. FS (Frame Store) Button

While pressing and holding down the FS button, press a channel button along the Preview row to switch the selected channel to a pre-loaded still picture.

Note: See [Section 5.3 Managing Still Pictures](#) for detailed instructions.



20. Grab Button

Press to capture images from the Program output to Still 1 or 2 buffer temporarily.

Note: See [Section 5.3 Managing Still Pictures](#) for detailed instructions.

Internal Settings

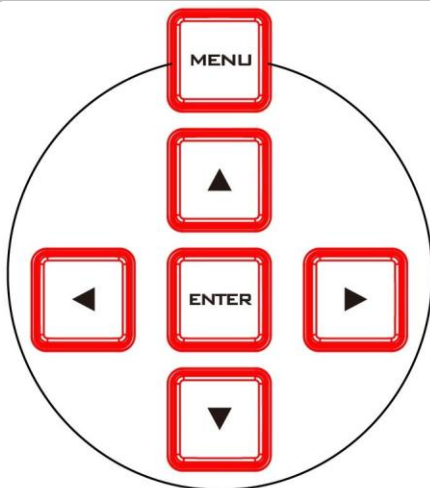

21. OSD Menu Control

Menu control buttons for opening the OSD menu on the connected Multiview monitor and navigating through the OSD menu. See [Chapter 4 OSD MENU](#) for descriptions of various sub menus and options.

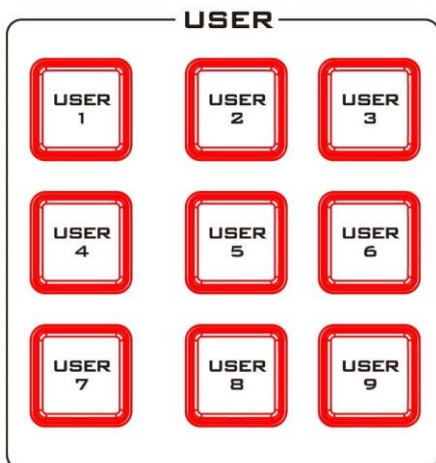

22. User Memory Buttons

User 1-9 Button allow the user to recall and load pre-saved switcher settings. There are 9 presets in total. See [User Mem](#)s for methods for saving to the 9 presets.

Audio Control



Headphone Jack

Headphone jack accepts the mini jack plug of the stereo headphone. The volume is controlled by the volume adjustment knob.

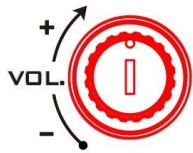

Volume Adjustment Knob

Rotate the knob to adjust the headphone's audio volume.

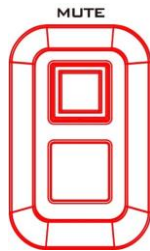

Mute Button

Press to mute the headphone.

Monitor Control



Power

Turn on/off the built-in monitor.

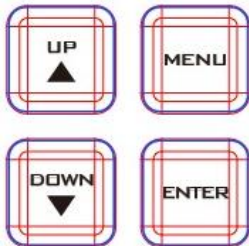

Menu Navigation Buttons

Press the MENU button to display the monitor's setup menus.

Press the UP and DOWN buttons to navigate the displayed menu.

Press the ENTER button to select the highlighted option.

See [Chapter 7 Monitor](#) for more details.

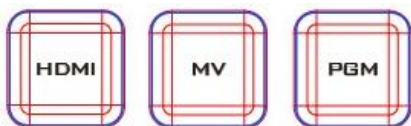

Video Mode Buttons

Press the corresponding video mode buttons to enable different video modes on the built-in monitor.

HDMI: External HDMI video IN

MV: Multiview mode

PGM: Program video

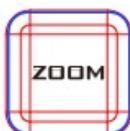

ZOOM

This feature is designed for use with the 12G-SDI and HDMI sources above 720p resolution. Press this button to zoom in to the video on the display. This is strictly a zoom-in function and does not alter the native aspect ratio of the source pixels to fill the screen.

The **ZOOM** button allows you to toggle between **zoom ratios x1, x2, x4** and **x8**.

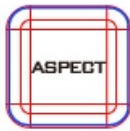

Aspect Ratio Button

Sets the aspect ratio to 16:9 or 4:3.

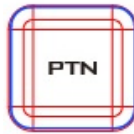

PTN

Press to display internally generated SMPTE 75% Colour Bars. Press again to return to the previously selected video input.



Check Field

The check field function offers the user Red-Only, Green-Only, Blue-Only and Mono modes for screen calibration.



Mute

Press to mute the monitor's internal speakers.

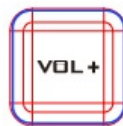

Volume Buttons

Press VOL+/VOL- to increase/decrease the internal speakers' volume.

Stream Control



Start/Stop Button

Press and hold for at least 2 seconds to enable/disable live streaming/recording depending on the operation mode selected.

- H
- M
- L

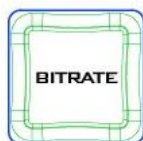

BITRATE

Use the **BITRATE** button to switch between **high (H)**, **moderate (M)** and **low (L)** bitrates for the selected operation mode (**RECORD only**, **STREAM only** and **RECORD and STREAM hybrid** modes).

See [Encoder](#) and [Section 8.4](#) for details.

- STM REC
- 264
 - 265

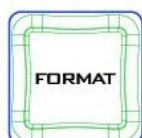

FORMAT Button

Press the **FORMAT** button to change the video compression standard. You can select either H.264 or H.265 for both streaming and recording.

The LED indicators will show you the standard selected.

See [Section 8.4](#) for details.

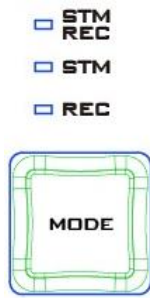

MODE

Press the **MODE** button to select the mode of operation for the video streaming server. The available modes are listed as follows:

STM+REC: Stream and record simultaneously

STM ONLY: Stream only

REC ONLY: Record only

The LED indicators will show you the selected mode of operation.

See [Section 8.4](#) for details.

External Storage

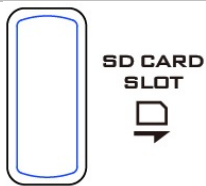

SD Card Slot

Insert an SD card into the SD card slot for video recording.

Note that you should only use Class 10 SD card or above. See the Appendix, [Recommended SD Cards](#), for a list of SD cards recommended by Datavideo.

Note: Do not remove SD card while recording is in progress as doing so may result in corrupted video files.

1.3 Connecting the Power Supply

Connect the DC output plug of the supplied AC adapter to the DC IN 12V connector on the rear of the switcher and then connect the AC adapter to a wall socket.

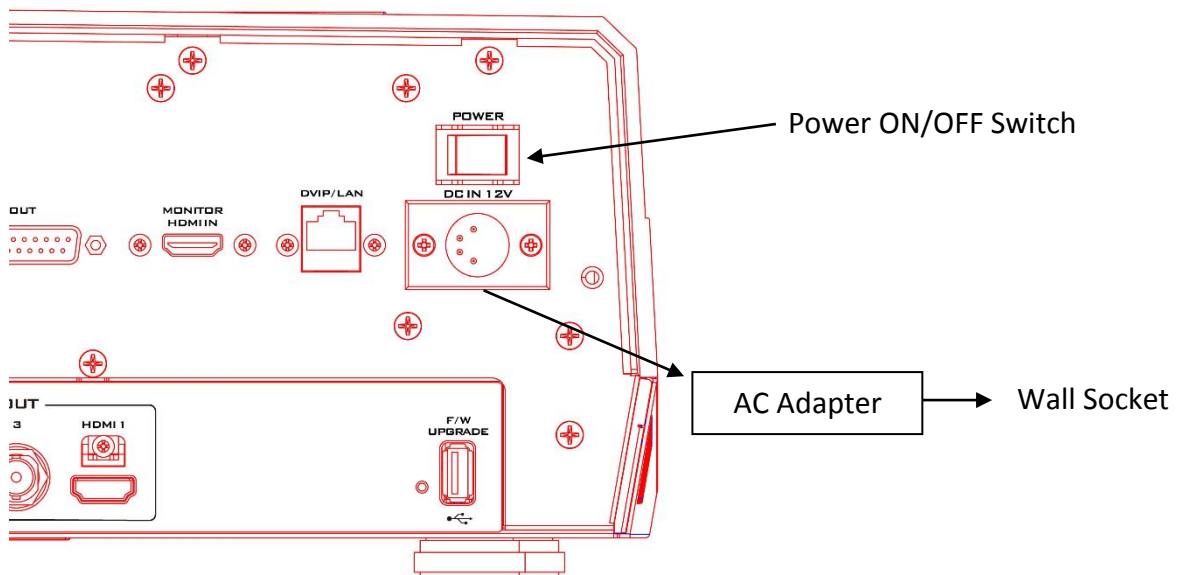

Chapter 2. Preparation

In this chapter, we will describe various essential devices to be connected to the switcher in order to complete the system setup. If you possess the skills for setting up the production system, feel free to skip this chapter and proceed to [Chapter 5: Basic Operation](#).

2.1 Connecting Devices

Connecting the Video and Audio Input Devices

Connect cameras, computers and other video input devices to the video input connectors on the rear of the unit and connect an audio mixer to audio input connectors.

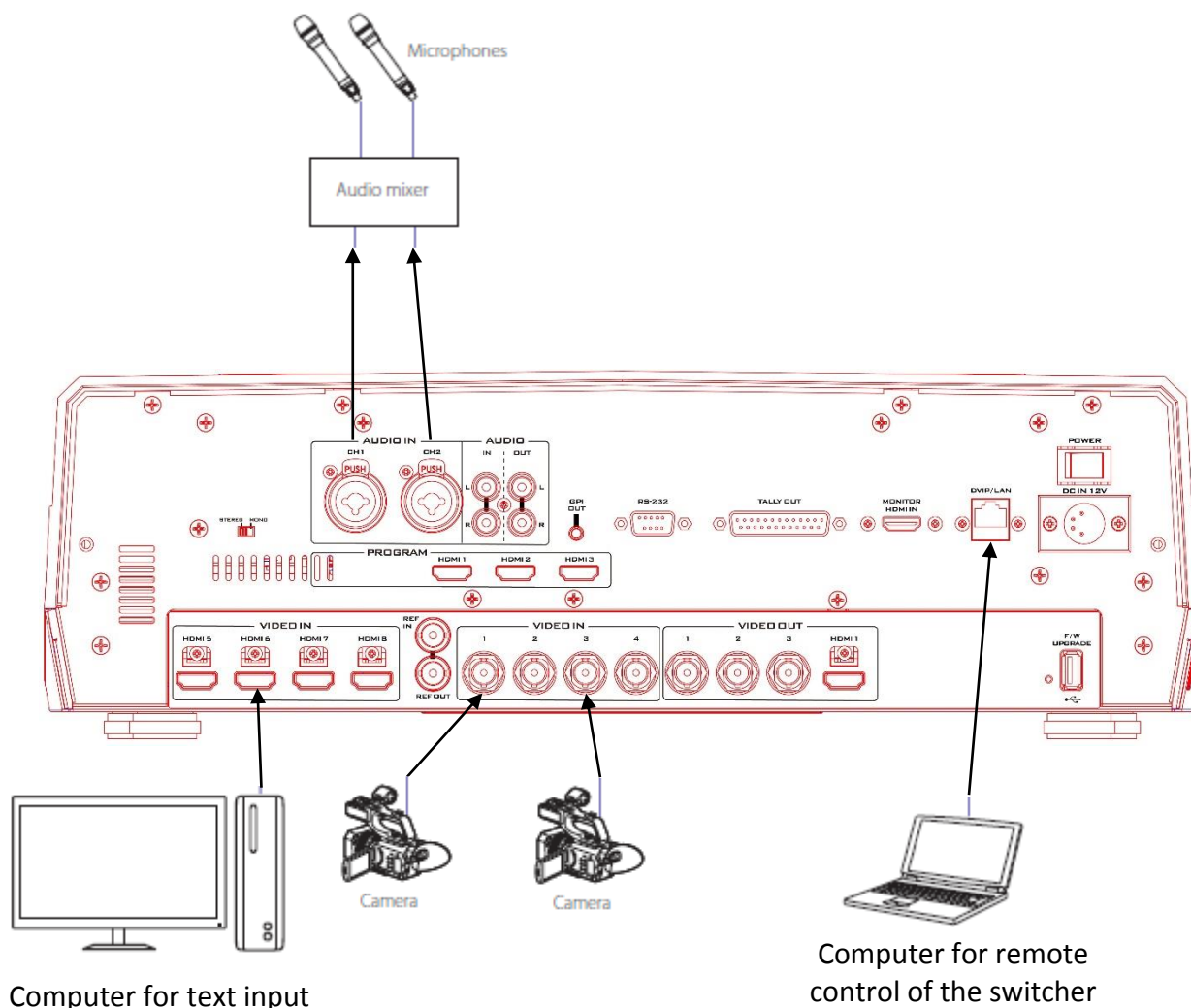

When linking via tally connection

Connect the switcher's tally connector to the tally connector on a commercially available tally box.

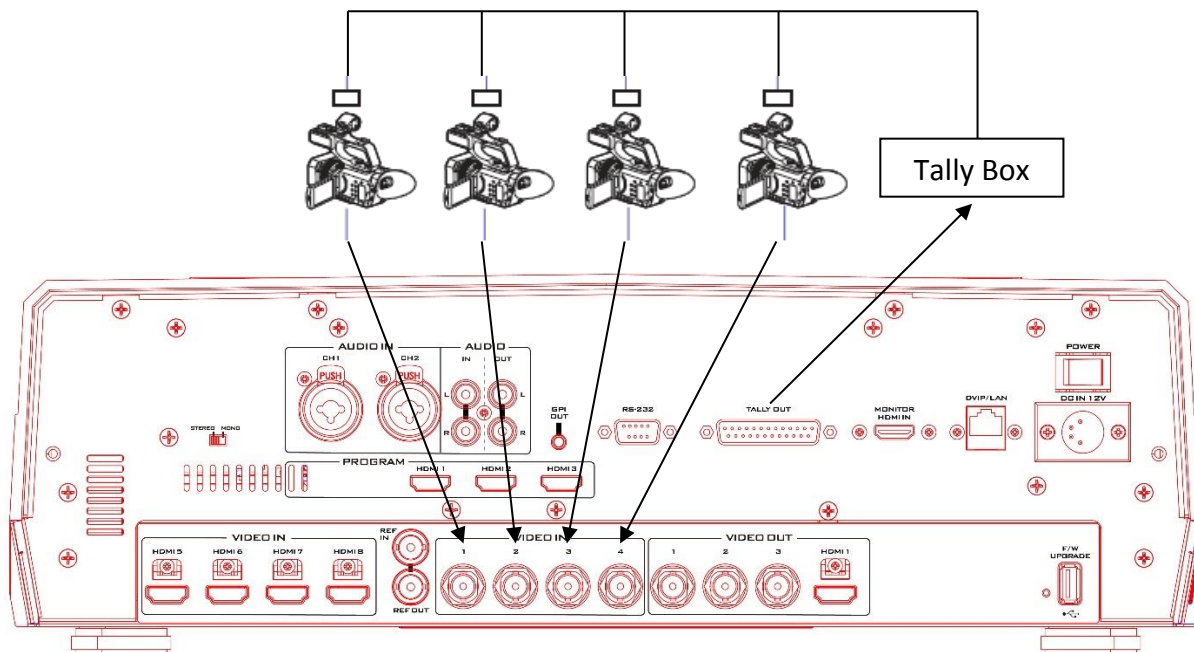

Connecting the Video and Audio Output Devices

Connect projectors, large displays and other video output devices to the video output connectors on the rear of the switcher.

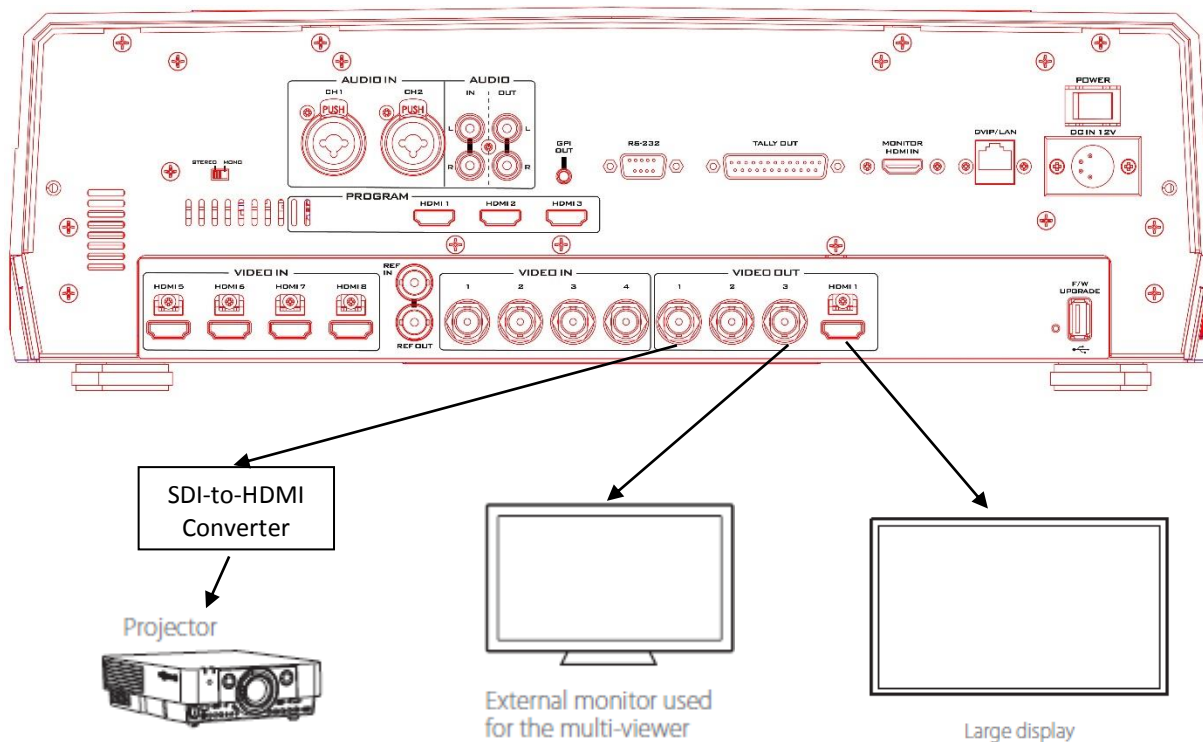

2.2 Network Setup

DVIP/LAN

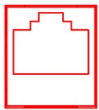

The Ethernet-based DVIP port on the back panel of the HS-2600 allows you to access the switcher and the NVS-32 streaming server from other devices such as a PC or an external controller. You can either use a static IP address to connect or connect via a router with DHCP.

The first sub-section discusses how you can connect directly to the switcher from a PC. In the second sub-section, we will show you how to connect via a DHCP router.

For information about NVS-32's network setup, see [Section 8.1](#). Please note that when using static IP to connect, you have to make sure the PC/controller, the switcher and the NVS-32 are given the IP addresses that have the same first three octets.

Static IP Configuration

When new from the factory the HS-2600 will initially have a static IP address of **192.168.100.101**. The switcher can be directly connected to a Windows-based computer using any standard Ethernet cables. The following should guide you to initially configure static IP settings for the PC as well as the HS-2600.

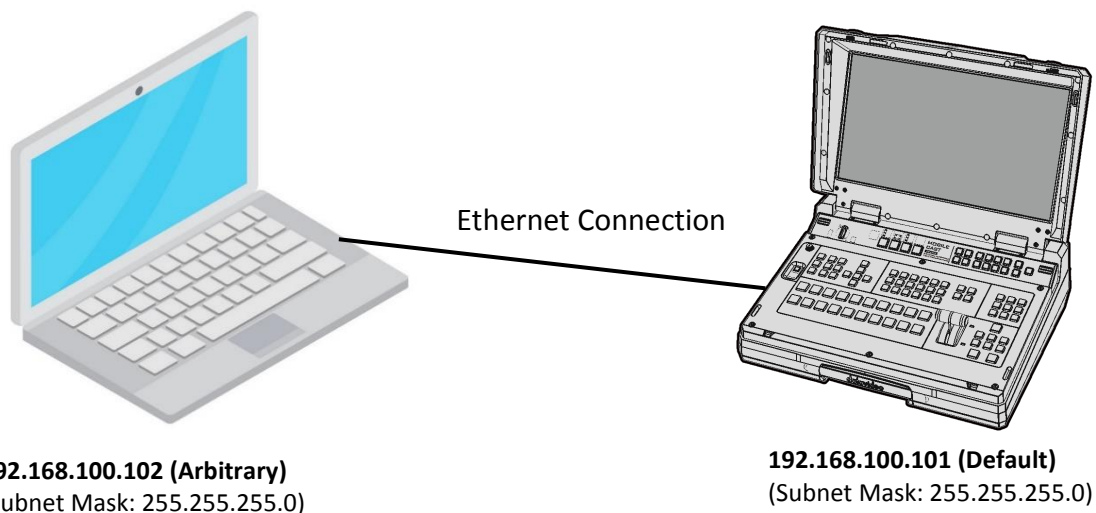

Instructions

1. First use an Ethernet cable to physically connect the HS-2600 to a Windows computer with the **Switcher Image Import/Export software** installed. If the **Switcher Image Import/Export software** is not installed on your PC, see [Chapter 4](#) of this manual for instructions on how to install and use the software.
2. Turn on the Windows computer and set it to **static IP setup** within the **Windows Network and Sharing Centre**. In our example, the computer is given the following IP settings so that the computer matches the same IP range as the switcher.

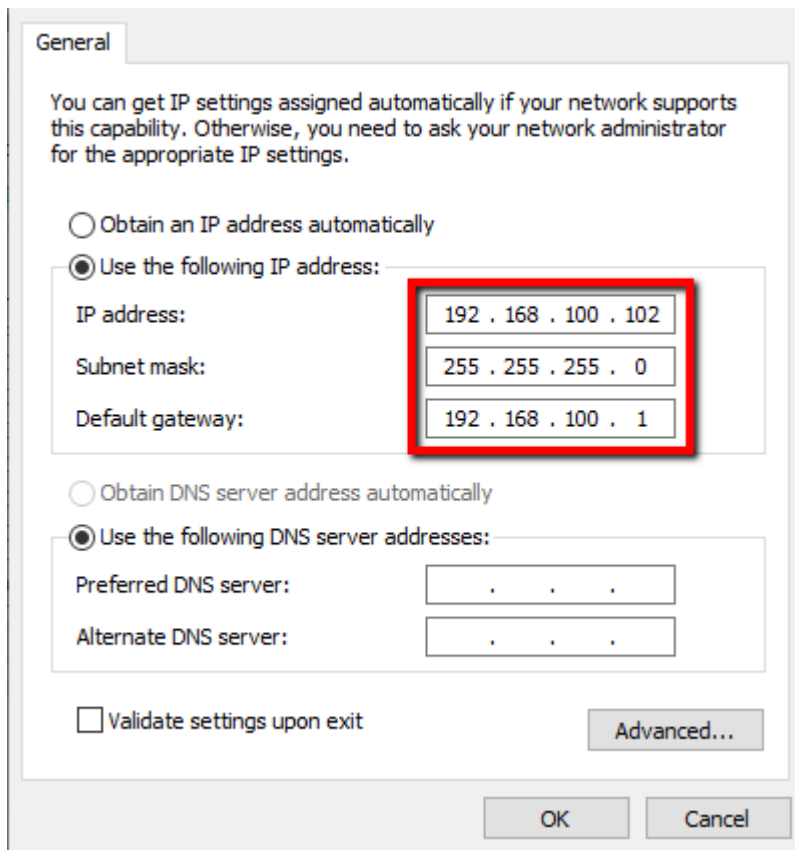

3. Now open the **Switcher Image Import/Export software** to establish connection with the switcher.

Tip: You can also modify the switcher’s IP address on the [OSD Menu](#) such that it matches the network IP range or the IP assigned to your PC. See the [Network](#) Section for details. This is also the place where you will be able to check or reset your device IP address. If you need to subnet your network which can be advanced to some, please consult your IT specialist for assistance if necessary. After changing your network settings, always reboot your switcher to apply new settings.

DHCP Mode

Dynamic Host Configuration Protocol (DHCP) is a network management protocol used to automate the process of configuring devices on IP networks. Once configured to DHCP, the device will be assigned an IP address by a DHCP server upon connection to the network.

Follow the steps below to set the switcher to DHCP:

1. Open the **OSD menu** on the built-in screen by pressing the **MENU** button on the HS-2600’s control panel.
2. Open the **Network** option in the **Setup** Sub-Menu then select **DHCP**. Select the **Save** option to save the change.

Addr Mode	DHCP			
IP Addr	192	168	100	101
Network Mask	255	255	255	0
		Cancel	Save	

3. After you've been prompted that the save is successful, reboot the HS-2600 then physically connect the device to a DHCP network or a router to receive an IP address assigned by a DHCP server.

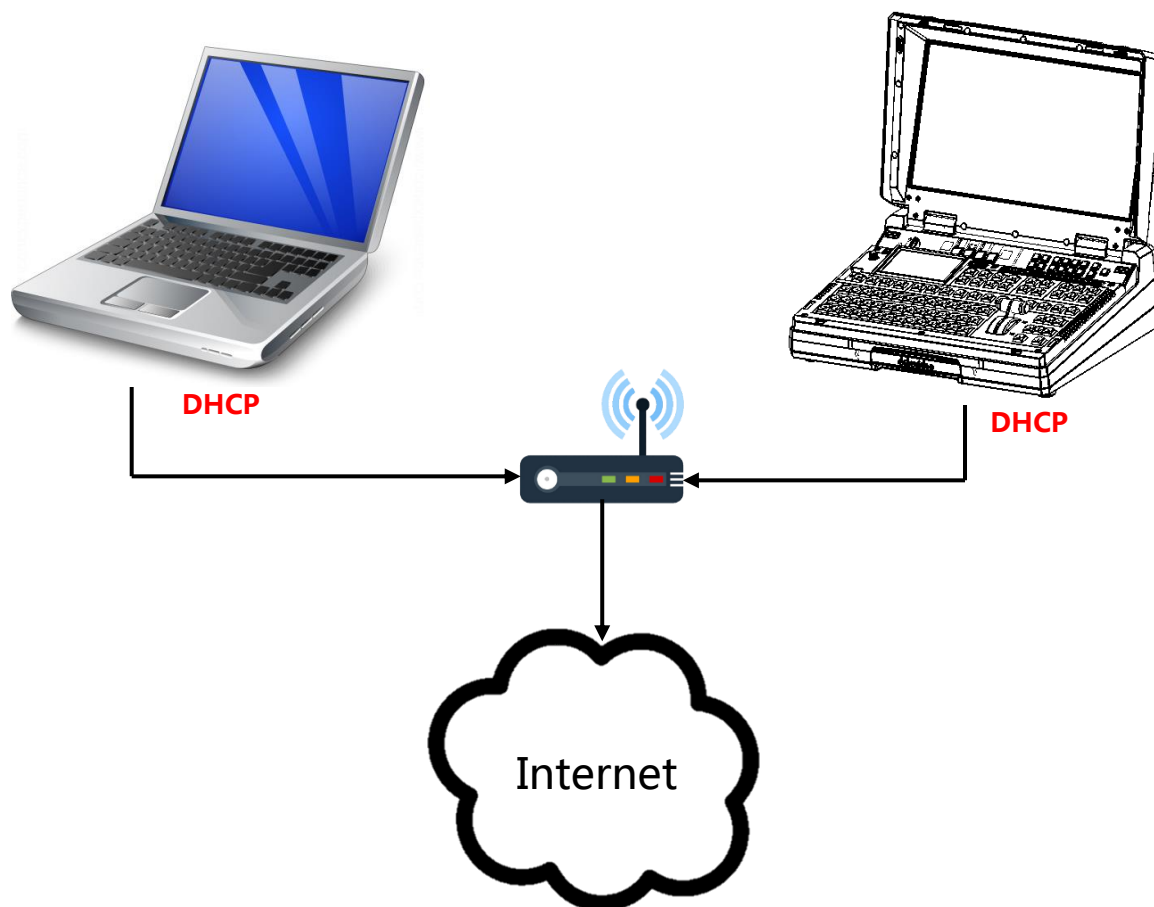

DVIP

DVIP is an Ethernet-based protocol designed by Datavideo to connect a network of Datavideo devices. DVIP Configuration Tool is a special network configuration software tool designed for DVIP device search on the same network and configuring device network settings such as Hostname, DHCP mode, IP address, subnet mask, gateway IP, and primary and secondary DNS.

Depending on your operating system, download DVIP Configuration Tool from the respective sites listed as follows:

PC: <https://www.microsoft.com/en-us/p/dvip-network-config/9p6gtz839k6s?activetab=pivot%3Aoverviewtab>

Android:

https://play.google.com/store/apps/details?id=com.datavideo.dvipnetconfig&hl=en_US

iOS: <https://itunes.apple.com/tw/app/dvip-network-config/id1177895983?mt=8>

After you've installed the DVIP Network Configuration Tool, follow the steps outlined below to scan for online DVIP devices and configure their corresponding settings.

Step 1: Open the DVIP Network Configuration Tool then select your PC or laptop's network interface card from the drop-down menu as shown in the diagram below.



Step 2: The DVIP Network Configuration Tool interface is shown below and you should see a list of the connected devices.

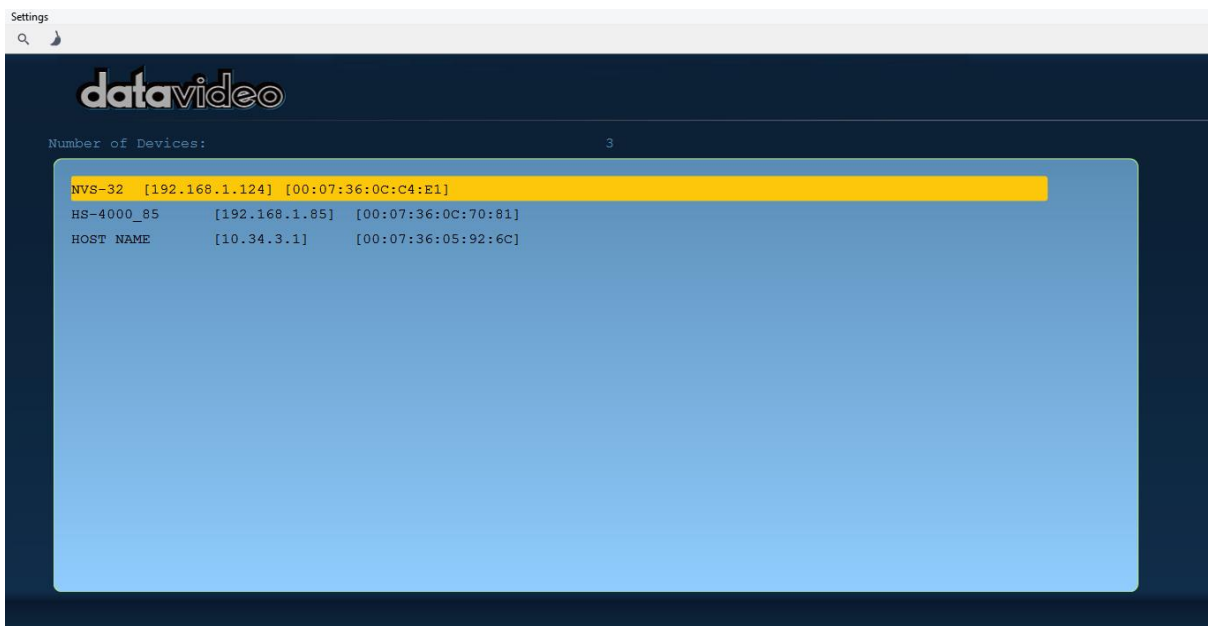

Step 3: Click one of the connected device to show its information and network settings in the pop-up window shown in the diagram below.

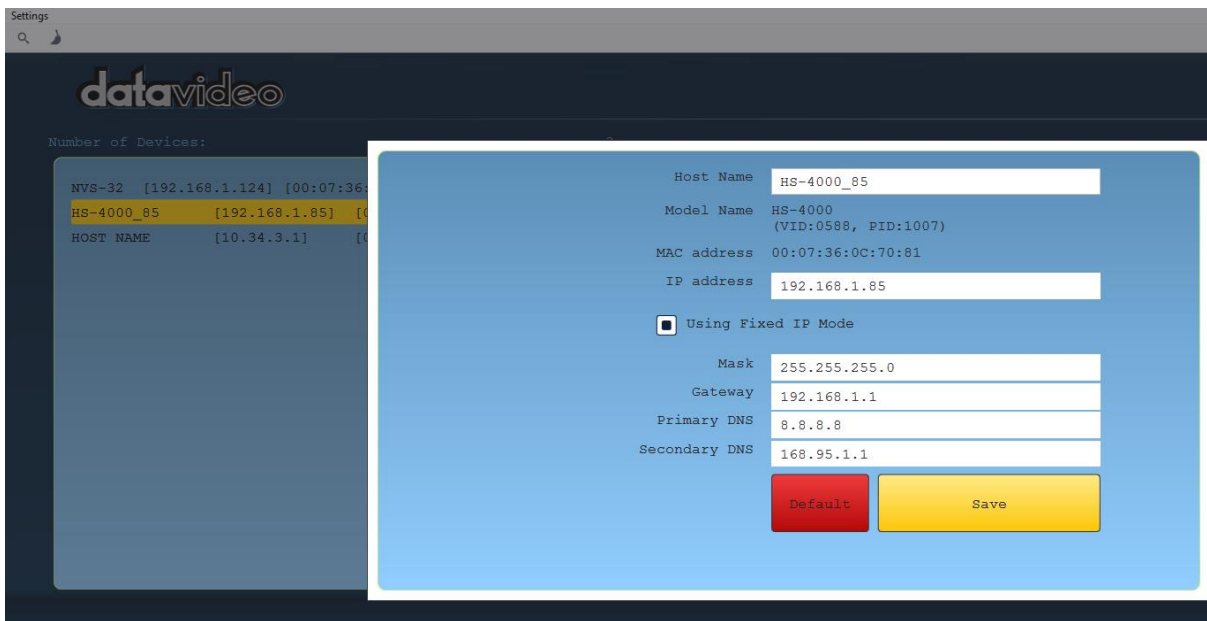

Step 4: You are allowed to change the device name in the Host Name field and modify the device's network settings accordingly. Click the Save button to confirm the change. To reset, simply click the Default button.

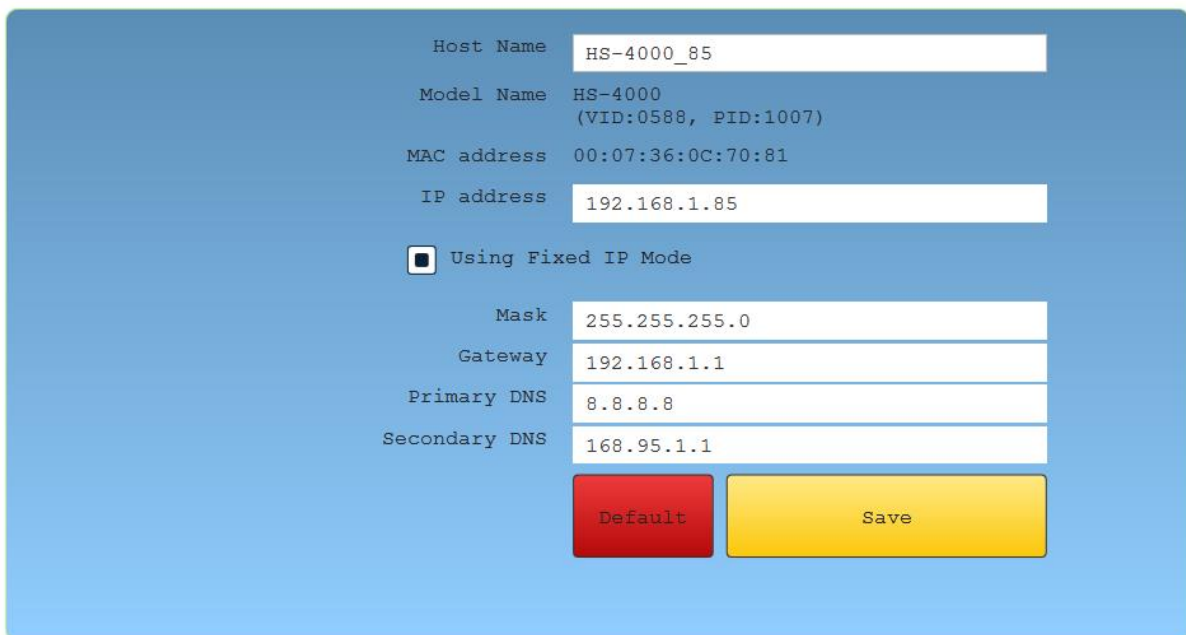

2.3 Multi View

The HS-2600 Multi view output can be supplied from the HDMI or SDI outputs, see Chapter 4 (4.7) for configuring the outputs. The Multi view shows monitoring images for **Preview** (PVW), **Program** (PGM) and **Inputs 1~8**. The Multi view can also show **audio level bars** overlaid on the Program image. This confirms the analogue XLR audio input is being received and embedded to the selected Program output(s).

HS-2600 Multi-view is supplied from the SDI/HDMI connection(s) on the rear panel and available across multiple SDI/HDMI monitors (not supplied). Since a variety of multi-image layouts is available, these outputs can be used to monitor video and audio in a number of

different configurations. The layout of the multi view can also be changed. The sources can be swapped around using the cross point section of the Inputs menu. For each setup, embedded audio level indication is available on the Preview and Program windows.

See [Multiviewer](#) in [Section 4.7](#) for nine different multi-view layouts available on the HS-2600.

Note: A Red tally indication box will be shown around the sources selected for Program OUT and these selected sources should be displayed at the switcher's selected Program output(s). **A Green tally indication box** is shown around the sources selected for Preview. These are the next image sources to be mixed to, wiped in or cut to the Program OUT depending on the user's preference.

Chapter 3. Software Setup for Switcher

The Ethernet port on the back panel of the HS-2600 allows the user to import still images, clips for stinger transition, still logos, animated logos or user memories using the Switcher Image Import/Export software. **Please download the Switcher Image Import/Export software to your PC or laptop from the product page (<https://www.datavideo.com/tw/product/HS-2600>) before using this feature.**

3.1 Switcher Image Import/Export Software

First select a connection mode and use the select mode to establish connection with the switcher. See [Section 2.2](#) for instructions.

Unzip the **Switcher Image Import/Export software** then in the unzipped folder, double click the software icon to open the program. The **Switcher Image Import/Export software** has a built-in IP finder, which is designed for PC with multiple Ethernet cards or DHCP network environment. Upon launch of the **Switcher Image Import/Export software**, you will be prompted to select one Ethernet Interface Card. **Please note that the IP finder can only find devices connected to the same network as the PC.**

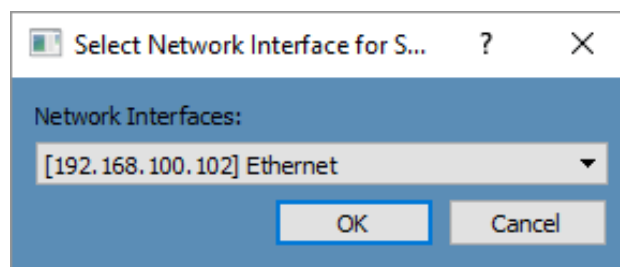

Once selected, click **OK** to start the scanning process.

Note: Please make sure the selected interface card is on the same network as the HS-2600 device.

Once the HS-2600 device is found, the software will connect with the switcher over the IP set up described in the previous section. If the connection is successfully established, on the software user interface as shown in the diagram below, the **Connect Status** will show **“Connected”** (will display **Not Connected** if disconnected).

Brief descriptions of buttons on the **MENU SELECT** pane are outlined as follows:

- **Home:** Interface main page showing connection status and transition time settings.
- **User:** User memory import
- **Still:** Still image import
- **Clip:** Clip file import
- **Logo:** Still logo import
- **Ani-Logo:** Animated logo import
- **Setup:** Software settings

Home

As soon as the program is opened, you will see the interface home as shown in the diagram below. The function items are described as follows:

- Connect Status: Shows “**Connected**” if the program establishes connection with the switcher successfully; shows “**Not Connected**” otherwise.
- ME Trans: Sets MIX EFFECT transition time in frames. See also OSD Menu → [Start](#) → **M/E**.
- DSK Trans: Sets DSK transition time in frames. See also OSD Menu → [Start](#) → **DSK**.
- FTB Trans: Sets Fade-to-Black transition time in frames. See also OSD Menu → [Start](#) → **FTB**.

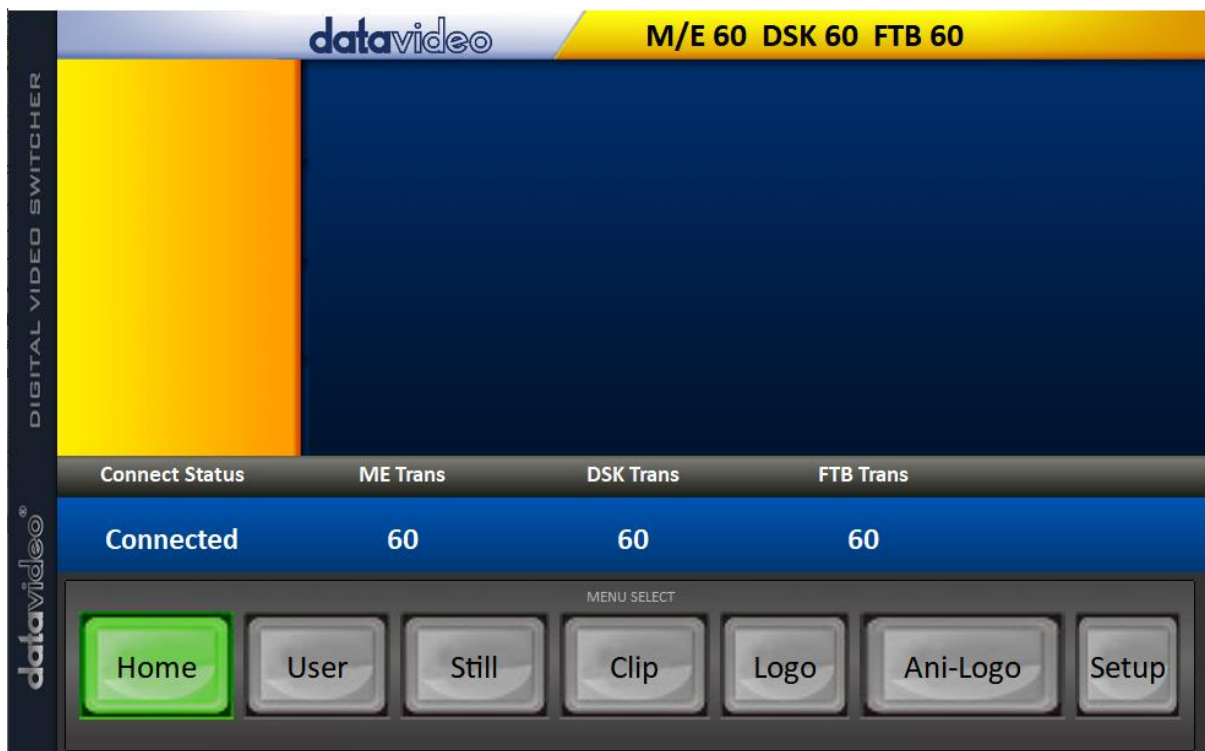

User

Click the **User** button to view all the .mem files saved on the switcher.

To import .mem files from your PC, click “**User**” then enter a memory location. Click “**Import User**” to browse your hard drive and select the user memory file that you would like to import.

See section 4.9, [User Mems](#), for more details.



Still

Click the **Still** button to view all the still images saved on the switcher.

To import still image files from your PC, click “**Still**” then enter a memory location. Click “**Import Still**” to browse your hard drive and select the image file that you would like to import.

See section 4.9, [Still](#), and section 5.3, [Managing Still Pictures](#), for more details.



Clip

Click the **Clip** button to view all the clips saved on the switcher.

To import clip files from your PC, click “**Clip**” then enter a memory location. Click “**Import Clip**” to browse your hard drive and select the clip file that you would like to import.

See section 4.9, [Clip](#), and section 5.4, [Performing a Stinger Transition](#), for more details.

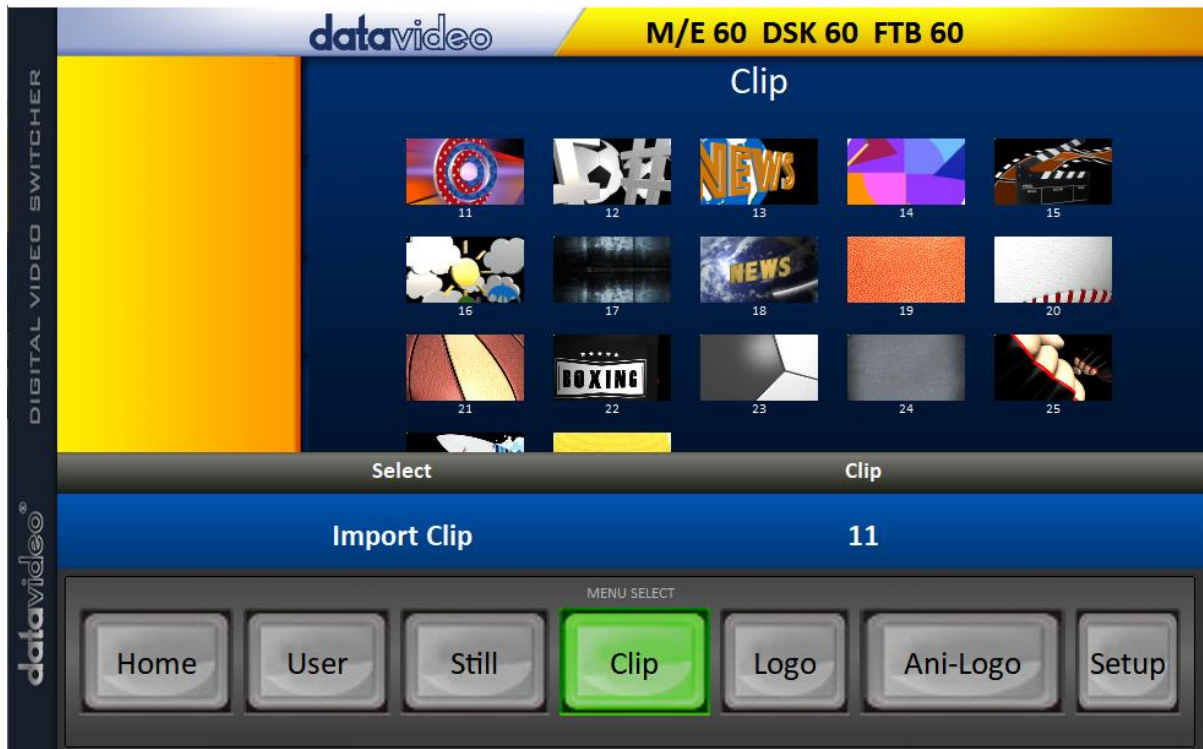

Logo

Click the **Logo** button to view all the still logo images saved on the switcher.

To import still logo image files from your PC, click “**Logo**” then enter a memory location.

Click “**Import Logo**” to browse your hard drive and select the logo image file that you would like to import.

See section 4.9, [Logo](#), and section 5.5, [Enabling Still Logo](#), for more details.



Ani-Logo

Click the **Ani-Logo** button to view all the animated logos saved on the switcher.

To import animated logo files from your PC, click “**Ani-Logo**” then enter a memory location. Click “**Import Ani-Logo**” to browse your hard drive and select the animated logo that you would like to import.

See section 4.9, [Ani-Logo](#), and section 5.6, [Enabling Logo Animation](#), for more details.



Setup

On the **Setup** page, you will be able to view the software version, network connect status, firmware version installed and the available space on the switcher.

The **Setup** page allows you to reset the software to its defaults, and change the interface language. The available languages are **English**, **Traditional Chinese**, and **Simplified Chinese**. Click **Save Setup** to apply the new settings.

The **Target IP Address** is the IP address of the switcher that you would like to connect. Enter the IP then click **SCAN** to connect to the switcher.

The screenshot displays the web interface for a datavideo switcher. At the top, the 'datavideo' logo is on the left, and the model 'M/E 60 DSK 60 FTB 60' is on the right. A vertical sidebar on the left contains the text 'DIGITAL VIDEO SWITCHER' and the 'datavideo' logo. The main content area shows system information:

Image Import/Export Software Version	0.0.3.0
Network connect status	Connected
Processor Unit software version	v0.9.9.9
FPGA Version	2019-7-22
Target IP Address	192.168.100.101
Network Mask	255.255.255.0
Gateway	192.168.1.254
Free Space	1073 frames

Below the table is a control bar with the following elements:

- Target IPAddr: 192.168.100.101
- Search Device: Scan
- Select: Factory Def
- Language: English
- Select: Save Setup

At the bottom, a 'MENU SELECT' bar contains several buttons: Home, User, Still, Clip, Logo, Ani-Logo, and Setup. The Setup button is highlighted in green.

Chapter 4. OSD MENU

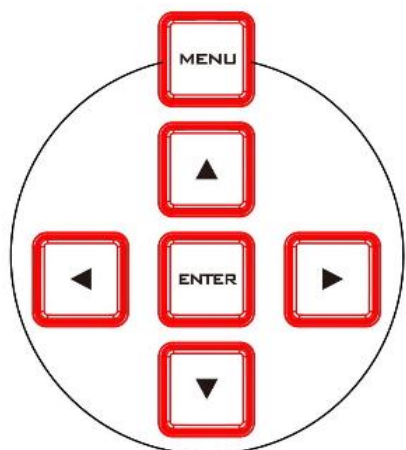

The switcher's OSD menu allows the user to perform several configurations of image effects, such as Picture-in-Picture, chroma key, subtitle overlay, still pictures and etc. The user can also configure the I/O by selecting different input and output options. In addition, in the setup menu, the user is allowed to set the menu color, size, position and language.

The OSD Menu can be opened in basic or advanced mode. The basic mode is generally a condensed version of the advanced menu mode. The following sub-sections will show you the various options available in these two modes.

Overview

Main Menu	Sub-Menu	Options	
Start	Transition (Duration)	M/E	Mix Effect (0 - 9999 Default: 15)
		DSK	Downstream Key Effect (0 - 9999 Default: 15)
		FTB	Fade-to-Black Effect (0 - 9999 Default: 60)
	Type	DVE	
		Clip	
		Wipe	
		Mix	
	Wipe Effects	Wipe	Wipe Effect Presets (1 - 32 Default: 1)
		Soft	Border Softness (0 - 100% Default: 0%)
		Width	Border Width (0 - 100% Default: 1%)
	Border	Luma	Border Color Luma (0 - 100% Default: 100%)
		Sat	Border Color Saturation (0 - 100% Default: 80%)
		Hue	Border Color Hue (0 - 355 +/-5 Default: 0)
	Position	X	Horizontal Position (0 - 1600% Default: 0%)
		Y	Vertical Position (0 - 1600% Default: 0%)
Matte	Luma	Background Matte Luma (0 - 100% Default: 100%)	
	Sat	Background Matte Saturation (0 - 100% Default: 80%)	
	Hue	Background Matte Hue (0 - 355 +/-5)	
Keyer	Keyer	DSK 2 DSK 1 Key 4 Key 3 Key 2 Key 1 Flex Key 1	Keyer Selection (Default: Key 1)
		Fine / Normal	Fine: High keying quality Normal: Original keying quality
	Keyer Ctrl	Full Chroma	Type of Keyer (Default: Linear)

		Luma Linear		
		Select one	P-in-P Self Split	Self: One input keyer (Default) Split: Dual input keyer P-in-P: Applying the keying effect to PIP window.
		Lift		Parameter for dark/black areas of the overall foreground key image, ranging from -100% to +100% (Default: 0%).
		Gain		Parameter for light/white areas of the overall foreground key image, ranging from 0 to 16.0 (Default: 1.0).
		Opac		Parameter for transparency of the overall foreground key image, ranging from 0% to 100% (Default: 100%).
		Invert		OFF: Luma key removes black background by default ON: Luma key removes white background after INVERT is turned ON .
	Key Source	Bars Matte Flex Src 1 Still 2 Still 1 Input 8 Input 7 Input 6 Input 5 Input 4 Input 3 Input 2 Input 1 Black		Key Source Selections (Default: Input 1)
		Fill		Fill Source Selection from Bars / Matte / Flex Src 1 / Still 2 / Still 1 / Input 8 / Input 7 / Input 6 / Input 5 / Input 4 / Input 3 / Input 2 / Input 1 / Black (Default: Black)
	Mask	Left		Left sets the left edge of the keyer mask (Default: 0%).
		Right		Right sets the right edge of the keyer mask (Default: 0%).
		Top		Top sets the top edge of the keyer mask (Default: 0%).
		Bottom		Bottom sets the bottom edge of the keyer mask (Default: 0%).
	Chroma	Keyer	Flex Key 1 DSK 2 DSK 1 Key 4 Key 3 Key 2 Key 1	Keyer Selection (Default: Key 4)

		Fine / Normal	Fine: High image quality Normal: Original image quality
	Key Source	Bars Matte Flex Src 1 Still 2 Still 1 Input 8 Input 7 Input 6 Input 5 Input 4 Input 3 Input 2 Input 1 Black	Key Source Selections (Default: Input 4)
	Key Tie	ON/OFF	Still 1/2 Input 1 – 8 Flex Src 1 Off
	CK Setup	CK Auto	Calculation of the best Hue & Luma values for the current Keyer source
		Hue	Parameter for color of the chroma key, ranging from 0 to 355 (Default: 110).
		Luma	Parameter for luma of the chroma key, ranging from 0 to 100% (Default: 80%).
		K Range	Setting the range of colors that match the background color to be keyed, ranging from 0 to 355 (Default: 160).
		K Fgnd	Adjusts the performance of the chroma key in dark or black areas, ranging from 0% to 100% (Default: 10%).
		K Bgnd	Adjusts the performance of the chroma key in light or white areas, ranging from K Fgnd value (min = 0) to 100% (Default: 20%).
		Hi-Light	Boosts the foreground key in high luminance area, ranging from 0 to 100% (Default: 0%).
		Lo-Light	Boosts the foreground key in low luminance area, ranging from 0 to 100% (Default: 0%).
		Bg-Supp	Bg-Supp turns ON/OFF background suppress (Default: OFF).
		Left	Trims the left edge of the key object (0 - 100% Default: 0%).
		Right	Trims the right edge of the key object (0 - 100% Default: 0%).
	Soft	Distinctiveness of key edge (0 - 100% Default: 0%)	
	Mask	Left	Left sets the left edge of the keyer mask (Default: 0%).
		Right	Right sets the right edge of the keyer mask (Default: 0%).

		Top	Top sets the top edge of the keyer mask (Default: 0%).	
		Bottom	Bottom sets the bottom edge of the keyer mask (Default: 0%).	
P-in-P	P-in-P	Key 1 Key 2 Key 3 (Default) Key 4 Flex PinP 1 Flex PinP 2 Flex PinP 3 Flex PinP 4	Selection of PIP windows	
		Fine	Normal Fine	
	Position	X	Horizontal PIP Position (-100 - 100% Default: -20%)	
		Y	Vertical PIP Position (-56 - 56% Default: 10%)	
		Size	PIP Size (2 - 100% Default: 40%)	
	Border	Border Off Normal Shaded 3D Bevel Bevel Shaded Dual Bevel Bevel Flat Flat Bevel 3D Glass Dual Glass Glass Flat Flat Glass Circle Circle Shaded Rounded Rounded Shaded	Selection of border style (Default: Normal)	
		Luma	PIP Border Luma (0 - 100% Default: 100%)	
		Sat	PIP Border Color Saturation (0 - 100% Default: 80%)	
		Hue	PIP Border Color Hue (0 - 355 +/-5 Default: 0)	
		Width	PIP Border Width (0 - 100% Default: 2%)	
		Soft	Distinctiveness of Border Edge (0 - 100% Default: 0%)	
		Opac	Border transparency (0 - 100% Default: 100%)	
		Shade Matte	Luma	Shade Matte Luma (0 - 100% Default: 100%).
			Sat	Shade Matte Saturation (0 - 100% Default: 80%).
			Hue	Shade Matte Color (0 - 355 +/-5 Default: 60).
	Shade Soft		This blurs or softens the Shade Matte area (0 - 100% Default: 2%).	
	Shade Pos		Sets position of the boundary line between Shade Matte and Border Matte (0 - 100% Default: 50%).	
	Direction		Direction of light source (0 - 355 +/-5 Default: 35).	

	Crop	Left	Left Edge of the Crop (0 - 100% Default: 0%).		
		Right	Right Edge of the Crop (0 - 100% Default: 0%).		
		Size	Size of the Crop (0 - 100% Default: 0%).		
		Top	Top Edge of the Crop (0 - 100% Default: 0%).		
		Bot	Bottom Edge of the Crop (0 - 100% Default: 0%).		
		Soft	Transparency and range of the crop edge (0 - 100% Default: 0%).		
Flex Src	Flex Src	Flex Src 1			
	Flex Src Bgnd	Bars Matte	Selection of Flex Screen sources and default is Black. Set ON to enable the respective P-in-P window, and OFF to disable.		
	P-in-P 1 Src	Flex Src			
	P-in-P 2 Src	Still 2			
	P-in-P 3 Src	Still 1			
	P-in-P 4 Src	Input 1-8			
		Black			
	Keyer 1	Key Source: Bars Matte Still 2 Still 1 Input 1-8 Black	Fill Source: Bars Matte Still 2 Still 1 Input 1-8 Black	Enable: ON/OFF	
	Keyer 2	Key Source: Bars Matte Still 2 Still 1 Input 1-8 Black	Fill Source: Bars Matte Still 2 Still 1 Input 1-8 Black	Enable: ON/OFF	
	Flex Preset	Preset 1 Preset 2 Preset 3 Preset 4 Preset 5 Preset 6	Selection of Flex Screen layout.		
Inputs	Input	Input 1-8	Selection of an input to set the mode (Default: Input 1).		
		Mode	Three input modes are Live, Freeze, and Still (Default is Live).		
		Mode	OFF	Mode disabled	
			CG Md	Enables CG mode Note: CG mode is only available when a CG image source is connected to one of the HDMI ports (Inputs 5 to 8).	
	Proc Amp	Black	Black level (0 - 100% Default: 0%)		
		White	White level (0 - 100% Default: 100%)		
		Chrom	Chroma level (0.0 - 16.0 Default: 1.0)		
	Audio	Gain	Audio volume of a selected video input (-60 - 24 dB Default: 0 dB).		

		Delay	Audio delay of a selected video input (0 - 340 ms Default: 0 ms).
	Crosspoint	Input 1-8 Off	Assign the selected input source to an input button (Default is Input 1).
	Audio XPT	Input 1-8 External Follow	Associate the audio component of a selected input source to an input button (Default is Follow).
Outputs	Output	SDI 1	Flex Src 1 Still 2 Still 1
		SDI 2	Input 1 – 8 CLN PVW (Clean PVW) CLN PGM (Clean PGM) PG + DSK
		HDMI 1	PVW PGM MultiV (Multi view) (SDI default: PGM / HDMI default: MultiV)
	Multiviewer	AutoNum	Auto number input labels (ON/OFF (Default))
		Label Inf	Input label is followed by information which describes the input as still, live or frozen image (ON/OFF (Default)). Please note that the label content cannot be modified.
		Trns Lab	Turn the background of the label from a solid colour to transparent (ON/OFF (Default)).
		MV1	Multiview Layout Modes User 1 – 4 Preset 1 – 3 Default: Preset 3
		L: PGM / R: PVW L: PVW / R: PGM	Default: L: PVW / R: PGM
	Tally Mode	Audio Mixer	Selection of tally light mode (Default: Normal)
		Normal	
	GPI Out	ON/OFF	GPI Enable/Disable (Default: OFF)
		Mode	Level/Pulse (Default: Pulse)
		Width	Pulse width (Default: 1)
		Input 1-8	GPI-out assignment (Default: Input 1)
		Delay	0-99 (Default: 0)
Audio	Audio	Mode	Turns ON/OFF embedded component at SDI-out and HDMI-out.
		Src	Selection of audio out source: PGM Audio (Default) / Follow / Input 1-8
	PGM Audio	Mode	Audio transition style: X Fade / V Fade (Default)
		Gain	Audio volume of a selected video input Range: -60 - 24 (dB) with default = 0 dB
		Delay	Audio delay of a selected video input Range: 0 - 340 ms with default = 0 ms
	Analog Out	Src	Selection of audio out source: PGM Audio (Default) / Follow / Input 1-8
		Gain	Audio out volume

			Range: -60 - 24 (dB) with default = 0 dB
		Delay	Audio out delay Range: 0 - 340 ms with default = 0 ms
Files – Stills	Load Still	Load	Pressing this button loads the selected still picture source
		Still Num	0-999 (Default = 1)
		Destination	Still 1 (Default) Still 2 Input 1 – 8
		Thumbnail Picture - 1	Preview of the previous image
		Thumbnail Picture	Preview of the image to be loaded
		Thumbnail Picture + 1	Preview of the next image
	Save Still	Save	Pressing this button saves the selected still picture
		Source	Still 1 (Default) Still 2 Input 1 – 8
		Still Num	0-999 (Default = 1)
		Delete	Remove still from a memory location
Grab Still	Grab	Press this button to grab the current program view	
	Grab Destination	Still 1 (Default) Still 2	
Files – User Memos	Load Mem	Memory	Memory Selection from 1 to 999 (Default: 1)
		Load	Selection of this button loads the selected memory
	Save Mem	Memory	Memory Selection from 1 to 999 (Default: 1)
		Save	Selection of this button saves to the selected memory
Files – Clip	Load Clip	Load	Selection of this button loads the selected clip
		Clip Memory Location	Memory locations from 0 to 999 (Default = 0)
		Clip Settings	Sets the clip's start and end frames and the transition frame. Start Frm End Frm Mid Frm
		Thumbnail Clip - 1	Preview of the previous clip
		Thumbnail Clip	Preview of the clip to be loaded
		Thumbnail Clip + 1	Preview of the next clip
		Clear Clip	Clear the loaded clip
		Delete Clip	Remove clip from a memory location
		Files – Logo	Load Logo
Logo Memory Location	Memory locations from 0 to 999		
Destination	Logo 1 Logo 2		
Thumbnail Logo - 1	Preview of the previous logo		
Thumbnail Logo	Preview of the logo to be loaded		

		Thumbnail Logo + 1	Preview of the next logo
		Clear Logo	Clear the loaded logo
		Delete Logo	Remove logo from a memory location
	Logo 1	X	X coordinate from -50 to +50
		Y	Y coordinate from -50 to +50
	Logo 2	X	X coordinate from -50 to +50
Y		Y coordinate from -50 to +50	
Files – Ani-Logo	Load Ani Logo	Load	Loads the selected animated logo
		Logo Memory Location	Memory locations from 0 to 999
		Destination	Logo 1 Logo 2
		Thumbnail Logo - 1	Preview of the previous animated logo
		Thumbnail Logo	Preview of the animated logo to be loaded
		Thumbnail Logo + 1	Preview of the next animated logo
		Clear Ani Logo	Clear the loaded animated logo
	Delete Ani Logo	Remove animated logo from a memory location	
	Logo 1	X	X coordinate from -50 to +50
		Y	Y coordinate from -50 to +50
	Logo 2	X	X coordinate from -50 to +50
		Y	Y coordinate from -50 to +50
Setup	Standard	1080p/50/59.94/60 1080i/50/59.94/60 720p/60/59.94/50	Resolution Selection
		Level	Audio Standards EBU SMPTE AUTO (Default)
		Save Setup	Saves the selected resolution
	Genlock	On/Off	
		H Phase	-2190 – 2190 ms
		V Phase	-1124 – 1124 ms
	Menu Mode	Advanced	Full (Default)
		Basic	Reduced
		Brightness	1 – 7 (Default: 5)
	Menu Pref	Blue / Grey	Selection of menu color
		Transp	Menu transparency level of 0/1/2 (Default: 1)
		Position	This option sets the menu position Bottom (Default) Right Left Top Centre
	Auto Save	ON / OFF	Automatically saves the last settings before the machine is shut down; once turned ON auto save also occurs upon every Still Load.
	Factory Def	Restore	Factory Default Reset loads the default configuration from memory point 0 for all configuration options except for the Setup.

		Restr Names	Resets the Multiviewer labels to the default settings
	Language	English Traditional Chinese Simplified Chinese	
	Network	Addr Mode	DHCP (Default) / Static
		IP Addr	
		Network Mask	
		Cancel / Save	
		Network Def	Yes / No
	Software	Upgrade	This starts the FW upgrade process See the <i>Firmware Upgrade</i> section for the USB firmware update process.

4.1 Start

The Start menu allows the user to set the transition time, the transition type as well as various wipe effects. The menu options are shown below.

Advanced mode

Start	Transition	M/E	15	DSK	15	FTB	60
	Type	MIX					
	Wipe Effects	Wipe	1	Soft	0%	Width	1%
	Border	Luma	100%	Sat	80%	Hue	0
	Position	X	0%	Y	0%		
	Matte	Luma	100%	Sat	80%	Hue	0

Basic mode

Start	Transition	M/E	15	DSK	15	FTB	60
	Wipe Effects	Wipe	1	Soft	0%	Width	1%

Transition

The **Transition** option allows the user to set the transition duration, in frames, for switching the PGM view when using the **AUTO**, **DSK** and **FTB** buttons.

For example, if the **M/E** is set to a value of 50, then the transition will take effect over a period of 50 frames or roughly 2 seconds. When the **AUTO button** is pressed, the transition will take the current M/E value defined by the user setting.

Type

The HS-2600 provides three major types of transition effect, which are **DVE (3D)**, **MIX**, **WIPE (2D)** and **Clip**. Please note in addition to selecting the transition effect on the OSD menu, you can also press **MIX button**, **WIPE/DVE button** or **CLIP button** to enable the respective transition effects.

- If **DVE** is selected, select the corresponding 3D WIPE effect by pressing the DVE buttons on the control panel. These DVE buttons are:

DVE 1: Wipe from left to right

DVE 2: Wipe from top to bottom

DVE 3: Wipe from right to left

- For **MIX** effect, set the transition time in “**Start → Transition → M/E.**”
- For **WIPE** effect, set the relevant WIPE settings in “**Start → WIPE Effects.**”
- For **Clip**, also known as the **Stinger Effect**, please first load the clip in “**Files → Clip.**”

Wipe Effects

In “**WIPE Effects,**” the user is allowed to select the Wipe style and configure the wipe’s border softness and width.

- **Wipe** – Selection of a WIPE effect from a set of 32 WIPE transition effects.
- **Soft** – A low value results in a solid edge and a high value gives a soft diffused edge.
- **Width** – A low value results in a thin edge and a high value gives a wide edge.

WIPE Border

In this sub-option, the user will be allowed to fine-tune the border color by adjusting the **Luma**, **Saturation** and **Hue** values.

Note: Enable the WIPE border by setting the border width (Width) to a value greater than 0. The WIPE border is disabled when the border width is set to 0.

Position

Position allows the user to adjust the center position of certain wipes (e.g Circle & Ellipse). **X** represents the horizontal position and **Y** is the vertical position.

Horizontal Position (X)

Positive value moves the wipe center to the right.

Negative value moves the wipe center to the left.

Zero value positions the wipe center at the screen center

Vertical Position (Y)

Positive value moves the wipe center up.

Negative value moves the wipe center down.

Zero value positions the wipe center at the screen center.

Matte

The user can open the Matte view by pressing the **BLK** button of the **Program** and **Preset** button rows. The color of the Matte is configurable in this sub-option by adjusting **Luma**, **Saturation** and **Hue**.

For **Hue** value, **Red** is 0, **Green** is approximately 120 and **Blue** is approximately 240. For secondary colors, **Yellow** is approximately 60, **Cyan** is approximately 180 and **Violet** is approximately 300.

The **Sat** or **Saturation value** refers to the intensity of the color selected in **Hue**. As the saturation increases, the color appears to be more pure. As the saturation decreases, the color appears to be more washed-out or pale.

The **Luma value** relates to how bright or dark the selected color or hue is. The higher the **Luma** value, the brighter the color selected in **Hue**.

4.2 Keyer

Keyer of the HS-2600 provides the user with the capability of image keying. In this sub menu, the user will be able to configure the **seven** keyers available on the HS-2600.

Advanced/Basic mode

Keyer	Keyer	Key 4	Normal	
	Keyer Ctrl	Chroma	Self	Opac 100%
		Lift 0%	Gain 1.0	Invert Off
	Key Source	Input 4	Fill Black	
	Mask	Left 0%	Right 0%	
		Top 0%	Bot 0%	

Keyer

The keyer options are **Key 1, Key 2, Key 3, Key 4, DSK 1, DSK 2** and **Flex Key 1**.

Key 1 – 4 are usually configured for luma and chroma keyers so select **Self** since only one source is enabled for such keyers.

The DSK keyer options are **Linear** and **Luma**. After the DSK keyer option is chosen, select **Self** if only one source is enabled for DSK keyer, which is the Key source. Select **Split** if two sources are enabled for the DSK keyer, which are Fill and Key sources. An example of a Linear DSK self setup could be using an HDMI input from a Windows laptop running Datavideo's CG-500 Character Generator software; see [Character Generator](#) for more information.

Once configured, the keyers can be activated by pressing the corresponding keyer buttons on the switcher's control panel except Flex Key 1 which can only be enabled in the Flex Src sub menu. Please note that the Flex Keys, once configured and enabled, are displayed along with the Flex Screen. See [Flex Src](#) → [Keyer](#) for instructions on setting Flex Keys.

Select **Fine** if you require high keying quality and **Normal** for original keying quality.

Keyer Control

There are three keying modes available: **Linear, Luma, and Chroma**.

Please note that if you select Full, the keying effect will be disabled, keeping the original source image. For example, if you select Full → PIP, the keying effect will not be applied to the PIP image source.

Linear keying mode is usually chosen for sharp images as it is usually used in professional graphic design. For non-sharp images, please select **Luma** keying for basic text images. **Chroma** keying mode allows you to remove the green or blue backdrop from the image and is usually used in overlapping talent on a background image.

After the keying mode is chosen, select **Self** if only one source is required for the keyer, which is Key source. Select **Split** if two sources are required for the keyer (DSK), which are Key and Fill sources. You can also select **P-in-P** to apply the keying effect to the PIP image source.

If **Luma** keying is selected, the key image (**Key Source**) is configured by adjusting **lift**, **gain** and **opacity** parameters.

Lift adjusts the dark/black areas of the key image. **Reducing the value of Lift** will make dark areas of the key image more transparent. The background image will be showing only through the transparent areas.

Gain adjusts the light/white areas of the key image. **Increasing the value of Gain** will make light areas of the key image more solid. The background image will be showing only through the transparent areas.

Opac adjusts the transparency of the overall foreground key image. **Increasing the value of Opacity** will make the overall key image less transparent.

Please note:

If Chroma is selected, adjust the Chroma Keyer parameters in the Chroma sub menu.

If P-in-P is selected, adjust its parameters in the P-in-P sub menu.

For example, if the user selects **Key 1 → Chroma → P-in-P**, you will then be able to apply the chroma key effect to the P-in-P window by configuring the corresponding chroma keyer parameters in the **Chroma** sub menu.

In the example below, after Keyer 1 is configured, by pressing **Key 1 PGM or PVW** button on the switcher’s control panel, the user will thus be able to enable the P-in-P window on the respective display monitor with the chroma key effect applied.

Keyer	Keyer	Key 1	Normal		
	Keyer Ctrl	Chroma	P-in-P	Opac	100%
		Lift 0%	Gain 1.0	Invert	Off
	Key Source	Input 1	Fill Black		
	Mask	Left 0%	Right 0%		
		Top 0%	Bot 0%		

Key Source

This option allows the user to assign the key source; various options are listed below:

- Bars: Color bars
- Matte: A configurable color screen and the Matte value can be set in **Matte** option of the **Start** menu
- Flex Src 1: Flex source view (See [Flex Src](#) option menu)
- Still 1/2: Still picture loaded to Still 1/2 buttons
- Input 8: Image source loaded to input button 8
- Input 7: Image source loaded to input button 7

- Input 6: Image source loaded to input button 6
- Input 5: Image source loaded to input button 5
- Input 4: Image source loaded to input button 4
- Input 3: Image source loaded to input button 3
- Input 2: Image source loaded to input button 2
- Input 1: Image source loaded to input button 1
- Black: Black Screen

Fill Source

This sub-option allows the user to assign the fill source; various options are listed below:

- Bars: Color bars
- Matte: A configurable color screen and the Matte value can be set in **Matte** option of the **Start** menu
- Flex Src 1: Flex source view (See [Flex Src](#) option menu)
- Still 1/2: Still picture loaded to Still 1/2 buttons
- Input 8: Image source loaded to input button 8
- Input 7: Image source loaded to input button 7
- Input 6: Image source loaded to input button 6
- Input 5: Image source loaded to input button 5
- Input 4: Image source loaded to input button 4
- Input 3: Image source loaded to input button 3
- Input 2: Image source loaded to input button 2
- Input 1: Image source loaded to input button 1
- Black: Black Screen

Invert

Configure the luma key color

OFF: Luma key removes black background by default.

ON: Luma key removes white background after **INVERT** is turned **ON**.

Mask

The Mask feature basically shrinks the source image by removing borders of the final image. In this option, the user is allowed to configure the Mask in chroma, luma or linear mode by adjusting **Left**, **Right**, **Top** and **Bottom** parameters.

- **Left** – Left sets the left edge of the keyer mask.
- **Right** – Right sets the right edge of the keyer mask.
- **Top** – Top sets the top edge of the keyer mask.
- **Bottom** – Bottom sets the bottom edge of the keyer mask.

4.3 Chroma

The Chroma Keyer removes the green background of the key image. If **Chroma** is selected in **Keyer**, this option menu allows you to configure the corresponding parameters.

Advanced/Basic mode

Chroma	Keyer	Key 4	Normal		
	Key Source	Input 4			
	Key Tie	On	Input 6		
	CK Setup	CK Auto	Hue	110	Luma 80%
		K Range 160	K Fgnd	10%	K Bgnd 20%
		Hi-Light 0%	Lo-Light	0%	Bg-Supp OFF
		Left 0%	Right	0%	Soft 0%
	Mask	Left 0%	Right	0%	
		Top 0%	Bot	0%	

Keyer

First of all, select the **Keyer** (**Key 1, Key 2, Key 3, Key 4, DSK 1, DSK 2 or Flex Key 1**) that you would like to apply the chroma key effect to and then select one **Key Source** from all available Key Sources listed below.

Select **Fine** if you require high keying quality and **Normal** for original keying quality.

Key Source

This sub-option allows the user to assign a key source to the keyer selected; various options are listed below:

- Bars: Color bars
- Matte: A configurable color screen and the Matte value can be set in **Matte** option of the **Start** menu
- Flex Src 1: Flex source view (See [Flex Src](#) option menu)
- Still 1/2: Still picture loaded to Still 1/2 buttons
- Input 8: Image source loaded to input button 8
- Input 7: Image source loaded to input button 7
- Input 6: Image source loaded to input button 6
- Input 5: Image source loaded to input button 5
- Input 4: Image source loaded to input button 4
- Input 3: Image source loaded to input button 3
- Input 2: Image source loaded to input button 2
- Input 1: Image source loaded to input button 1
- Black: Black Screen

Key Tie

Key tie is a feature that allows you to overlap a foreground image on a background image. The key tie image can then be opened by pressing the input button to which the background image is assigned. Note that the keyer button will be disabled if key tie is enabled for the corresponding keyer. Outlined below are steps to set key tie with the chroma keyer.

1. First, in the Keyer menu, select the keyer and set it to Chroma. We used Key 1 in this example.

Keyer	Keyer	Key 1	Normal	
	Keyer Ctrl	Chroma	Self	
		Lift 0%	Gain 1.0	Opac 100%
	Key Source	Input 3	Fill Input 8	Invert Off
	Mask	Left 0%	Right 0%	
		Top 0%	Bot 0%	

2. Open the Chroma menu and select Key 1. Assign a foreground image to the Key Source (the foreground image is usually a person or an object against a green backdrop). In this case, it's Input 3.

Chroma	Keyer	Key 1	Normal	
	Key Source	Input 3		
	Key Tie	Off	Off	
	CK Setup	CK Auto	Hue 110	Luma 80%
		K Range 160	K Fgnd 10%	K Bgnd 20%
		Hi-Light 0%	Lo-Light 0%	Bg-Supp OFF
		Left 0%	Right 0%	Soft 0%
	Mask	Left 0%	Right 0%	
		Top 0%	Bot 0%	

3. Enable Key Tie and on the right, select a background image.

Chroma	Keyer	Key 1	Normal	
	Key Source	Input 3		
	Key Tie	On	Input 6	
	CK Setup	CK Auto	Hue 110	Luma 80%
		K Range 160	K Fgnd 10%	K Bgnd 20%
		Hi-Light 0%	Lo-Light 0%	Bg-Supp OFF
		Left 0%	Right 0%	Soft 0%
	Mask	Left 0%	Right 0%	
		Top 0%	Bot 0%	

4. After key tie is configured, to open the key tie image, simply press the input button of the background image selected at Step 3. In this example, input 6 is selected as the background so press button 6 of either the Preset or Program row to open the key tie image on the respective views.

Below are available sources of the background image:

- Still 1/2
- Input 1–8
- Flex Src 1
- Off

Note: You will not be able to use the keyer button once key tie is enabled. Use the input button that is assigned to the background image to open the key tie image.

CK Setup

In this sub-option, the user will be able to find all the parameters needed to perform chromakeying of the green or blue backdrop.

CK Auto: This function automatically calculates the best Hue & Luma values for the current Keyer source. After applying the CK Auto effect, the result can be fine-tuned by adjusting the Luma and Hue values.

Hue: This parameter adjusts the color of the chroma key. A typical green screen value will be around 120. Blue screen value will be around 240.

Luma: This parameter adjusts the luma value of the chroma key

K Range (Key Range): Key Acceptance sets the range of hues or colors (0 – 360 degrees) that closely match the background color to be keyed. The user can start with a value of 120 degrees and this value can be fine-tuned up or down depending on the setup of the green or blue screen studio.

K Fgnd (Key Foreground): **Key Foreground** adjusts the performance of the chroma key in light or white areas. Apply more **Key Foreground** if the light areas are becoming too transparent.

K Bgnd (Key Background): **Key Background** adjusts the performance of the chroma key in dark or black areas. Apply more **Key Background** if the dark areas are becoming too transparent.

Hi-Light: Hi-light boosts the foreground key in high luminance area.

Lo-Light: Lo-light boosts the foreground key in low luminance area.

Bg-Supp: Background Suppress removes the Luma (Brightness) of the background from the final image. **Bg-Supp** turns ON/OFF background suppression.

Left: Trims the left edge of the key object.

Right: Trims the right edge of the key object.

Soft: Determines the distinctiveness of key edge

Mask

The Mask feature basically shrinks the camera image by removing the borders from the final image. This feature allows the user to configure the Mask in chroma, luma or linear mode.

- **Left** – Left sets the left edge of the keyer mask.
- **Right** – Right sets the right edge of the keyer mask.
- **Top** – Top sets the top edge of the keyer mask.
- **Bottom** – Bottom sets the bottom edge of the keyer mask.

4.4 P-In-P

The **P-in-P** option allows the user to adjust all related P-in-P parameters. Use this option to configure your PIP window if **P-in-P** is selected in the **Keyer Ctrl** sub-option of the **Keyer** option.

Note: The P-in-P image source can only be selected in **Key Source** option of the **Keyer** Sub Menu.

Advanced/Basic mode

P-in-P	Keyer	Key 1			Fine	Normal
	Position	X	-20%	Y	10%	Size 40%
	Border	Normal				
		Luma	100%	Sat	80%	Hue 0
		Width	2%	Soft	0%	Opac 100%
	Shade Matte	Luma	100%	Sat	80%	Hue 60
		Shade Soft	2%	Shade Pos	50	Direction 35
	Crop	Left	0%	Right	0%	Size 0%
		Top	0%	Bot	0%	Soft 0%

Keyer

In this sub-option, the user will be allowed to select and configure the PIP window from the list below. Please note that Keyers 1-4 are active for PIP configuration only if P-in-P is selected in the Keyer sub-menu for the respective keyer.

- **Key 1**
- **Key 2**
- **Key 3**
- **Key 4**
- **Flex PinP 1**
- **Flex PinP 2**
- **Flex PinP 3**
- **Flex PinP 4**

Position

The user can adjust the P-in-P window position by adjusting values of **X**, **Y** and **SIZE**, where X is the horizontal position, Y is the vertical position and Size is the PIP screen size.

X-Value Positive value: position the P-in-P window to the right.
 Negative value: position the P-in-P window to the left.
 Zero value: Position the P-in-P window at the center.

Y-Value Positive value: move the P-in-P window up.
 Negative value: move the P-in-P window down.
 Zero value: Position the P-in-P window at the center.

Size Ranges from 0 to 100 with 1% being the smallest and 100 being the largest. So 50% would represent a P-in-P window which is half the size of the background image. 100% would see the PIP image totally cover the background image unless offset to one side.

Fine

Once enabled, you will then be able to fine tune the position of the P-in-P window by adjusting **X** and **Y** vales as well as the **Size**. This feature allows you to move the P-in-P window more precisely to the desired location and adjust its size.

Border

The user is also allowed to add borders to the PIP window and the HS-2600 offers various border styles listed as follows:

- Border Off
- Normal
- Shaded*
- 3D Bevel**
- Bevel Shaded*
- Dual Bevel**
- Bevel Flat**
- Flat Bevel**
- 3D Glass**
- Dual Glass**
- Glass Flat**
- Flat Glass**
- Circle**
- Circle Shaded*
- Rounded**
- Rounded Shaded*

****See Shade Matte/Hue for dual color border setting.***

*****See Shade Matte/Direction for border shadow setting.***

To turn the Border off, simply select the option “Border OFF.”

In addition to assigning a style to the border, the user is also allowed to set border color by adjusting **Luma**, **Saturation** and **Hue** values. **Luma** and **Saturation** range from 0 to 100%. **Hue** value ranges from 0 to 355. The borders can also be widened or narrowed by adjusting **Width**. Please note that a width of zero (0) will turn the PIP border off.

Opac adjusts the transparency of the border, ranging from 0% to 100%

Softness defines the distinctiveness of the border edge. A low value results in a solid border edge and a high value gives a soft diffused border.

Shade Matte (Dual Color Border)

In order for the **Shade** effect to work, **Shaded Border (Dual Color)** must be first selected as the **Border** – see the previous section [Border](#). Shade Matte determines the inner border. The boundary between the normal border matte and the shade matte can be determined by adjusting the **Shade Position** parameter.

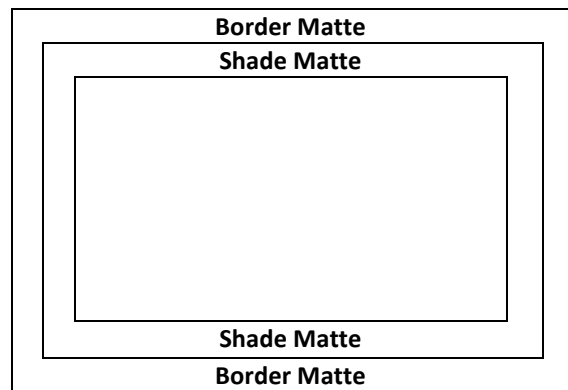

Luma, Sat and Hue

The color of the **Shade Matte** can also be controlled by adjusting the **Hue, Sat** and **Luma** values.

For **Hue** value, **Red** is 0, **Green** is approximately 120 and **Blue** is approximately 240. For secondary colors, **Yellow** is approximately 60, **Cyan** is approximately 180 and **Violet** is approximately 300.

The **Sat** or **Saturation value** refers to the intensity of the color selected in **Hue**. As the saturation increases, the color appears to be more pure. As the saturation decreases, the color appears to be more washed-out or pale.

The **Luma value** relates to how bright or dark the selected color or hue is. The higher the **Luma** value, the brighter the color selected in **Hue**.

Shade Softness, Shade Position and Direction

The **Shade Matte** can be further configured by adjusting its **softness (Shade Soft)** and **width (Shade Pos)**.

Shade Soft

This blurs or softens the **Shade Matte** area.

Shade Position

The position of the boundary line between **Shade Matte** and **Border Matte** is controlled by the **Shade Pos** value.

Increasing this value moves the boundary line such that the **Shade Matte** occupies less of the width of the border. Decreasing this value moves the boundary line such that the **Shade Matte** occupies more of the overall border width. When this value is 0, the **Shade Matte** occupies all of the border width.

Note: You will see dual colors only if options “Shaded” and “Bevel Shaded” are selected.

Direction

Direction sets the direction of the light source with the value of parameter ranging from 0 to 355. The default is 35, which indicates a direction of North East. You will see the border’s color shadow changes as the Direction value is changed. The directions that specific parameter values correspond to are listed as follows:

- 0: North
- 90: East
- 180: South
- 270: West

Crop

The PIP image crop can be adjusted by modifying the following parameters:

- **Left** – Adjusts the position of the left edge of the PIP image.
- **Right** – Adjusts the position of the right edge of the PIP image.
- **Size** – Adjusts the PIP image crop size.
- **Top** – Adjusts the position of the top edge of the PIP image.
- **Bot** – Adjusts the position of the bottom edge of the PIP image.
- **Soft** – Adjusts the crop edge transparency.

Note: You will sometimes see black thin lines on your PIP image after setting the PIP border to Normal with a border width of zero. This is caused by using an image that differs from its original size. To remove these lines, turn the border off or use the crop function to shrink the image until the lines disappear.

4.5 Flex Src

The Flex™ output allows the user to show a variety of sources at the same time. These image sources are fed as one combined image to the Program and Preset outputs.

The Flex™ output consists of one background image and four smaller source images overlapped on the background image in four separate individual PIP windows.

The HS-2600 offers the user one Flex™ output, which can be selected in “**Flex Src**” as shown in the Flex Src sub menu below. After selecting the Flex output, you can then start setting the source of input for each FLEX window as detailed in the next section.

Advanced/Basic mode

Flex Src	Flex Src	Flex Src 1		
	Flex Src Bgnd	Black		
	P-in-P 1 Src	Black	Enable	On
	P-in-P 2 Src	Black	Enable	On
	P-in-P 3 Src	Black	Enable	On
	P-in-P 4 Src	Black	Enable	On
	Keyer 1	Input 1	Input 2	Enable On
	Flex Preset	Preset 1	Preset 2	Preset 3
		Preset 4	Preset 5	Preset 6

Flex Screen

To set the source of input for the respective FLEX windows, open the OSD menu and select FLEX Src. On the sub-menu that opens, you will be able to see the following options allowing you to select the image sources to be displayed in the FLEX windows.

- Flex Src Bgnd: The background image is the image on which the FLEX windows are stacked.
- P-in-P 1 Src selects the image displayed in FLEX window 1.
- P-in-P 2 Src selects the image displayed in FLEX window 2.
- P-in-P 3 Src selects the image displayed in FLEX window 3.
- P-in-P 4 Src selects the image displayed in FLEX window 4.

The available sources of inputs are listed as follows:

- Black: Black Screen
- Input 1: Image source loaded to input button 1
- Input 2: Image source loaded to input button 2
- Input 3: Image source loaded to input button 3
- Input 4: Image source loaded to input button 4
- Input 5: Image source loaded to input button 5
- Input 6: Image source loaded to input button 6
- Input 7: Image source loaded to input button 7
- Input 8: Image source loaded to input button 8
- Still 1: Still picture loaded to Still 1 button
- Still 2: Still picture loaded to Still 2 button
- Matte: A configurable color screen and the Matte value can be set in **Matte** option of the **Start** menu
- Bars: Color Bars

Keyer

The Flex Keyer can be set to **Chroma**, **Luma** or **Downstream keyer**. In the [Keyer](#) sub menu, first select **Flex Key**. Then if a Chroma or Luma Self key setup is selected, only one source is enabled for the keyer, which is key source. If you've selected a DSK Split setup, then two sources should be enabled for the DSK keyer, which are Key and Fill sources.

In **Keyer** of the **Flex Src** sub menu, the first field corresponds to the key source and the second field selects the fill source.

P-in-P 3 Src	Black	Enable	On
P-in-P 4 Src	Black	Enable	On
Keyer 1	Input 1	Input 2	Enable On
Flex Preset	Preset 1	Preset 2	Preset 3
	Preset 4	Preset 5	Preset 6

First field = Key source

First field = Fill source

If you've selected **Chroma key setup**, the keyer can be configured in [Chroma](#) sub menu.

If you've selected **Luma key setup**, adjust Lift, Gain and Opac in [Keyer](#) sub menu.

For a Linear DSK self setup, a good example could be using an HDMI input from a Windows laptop that is running Datavideo's CG-500 Character Generator Software; see [Character Generator](#) for more information.

Key source and Fill source will be required for a DSK split setup. The steps outlined below will guide you through the configuration process of such.

System Hardware Setup

1. Connect the laptop (with CG-500 installed) to one of the HDMI input ports on the HS-2600 using an HDMI cable. In this example, we will be using HDMI input port 5 (Input Channel 5).
2. Open CG-500 on the laptop and create a CG image.
3. Switch ON the HS-2600's power button and after the boot up is complete, the Multiview should be displayed on the connected monitor.
4. The Input 5 window on the Multiview should show the CG image.

Menu Settings

5. Follow the menu path [Keyer](#) → [Keyer](#) and select **Flex Key 1**.
6. Follow the menu path [Keyer](#) → [Keyer Ctrl](#) and set the **Flex Key** to a **linear** or **luma** DSK split keyer.
7. Follow the menu path [Flex Src](#) → **Keyer 1** and set CG Overlay inputs by selecting **Input 5 in both Key and Fill fields**.

Flex Src	Flex Src	Flex Src 1		
	Flex Src Bgnd	Black		
	P-in-P 1 Src	Black	Enable	On
	P-in-P 2 Src	Black	Enable	On
	P-in-P 3 Src	Black	Enable	On
	P-in-P 4 Src	Black	Enable	On
	Keyer 1	Input 5	Input 5	Enable On
	Flex Preset	Preset 1	Preset 2	Preset 3
		Preset 4	Preset 5	Preset 6

8. After the keyer is configured, enable the keyer and on the switcher's control panel, press and hold the **SHIFT** button then press the **3/FLEX** button on either the Preset or Program row to view the Flex screen with CG enabled.

Flex Preset

The HS-2600 offers the user three FLEX Screen layouts. The respective **default** layouts are shown in the diagrams below.

Preset 1

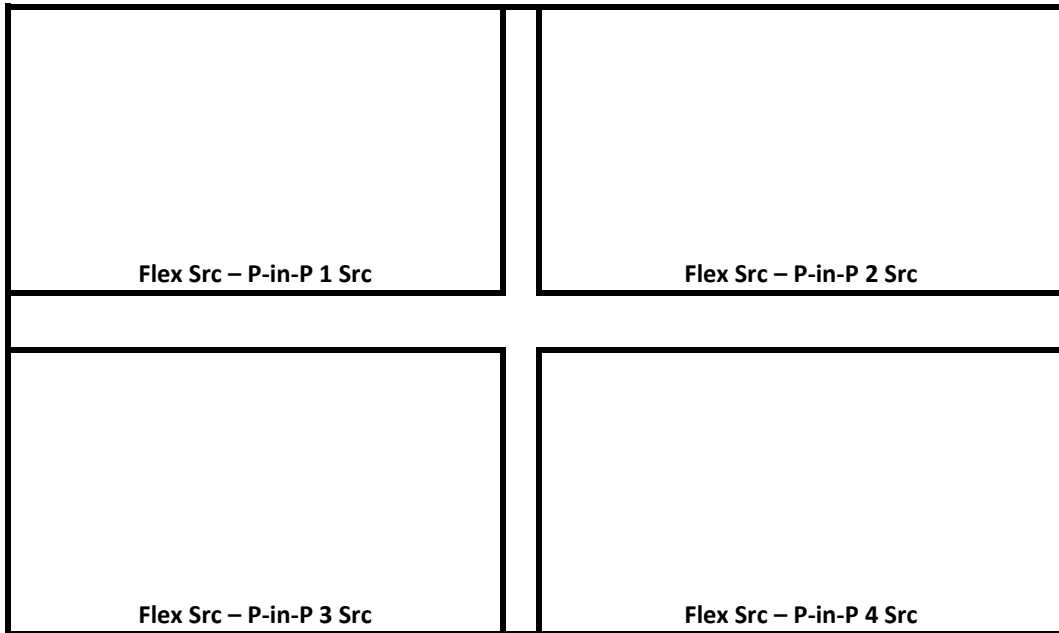

Preset 2

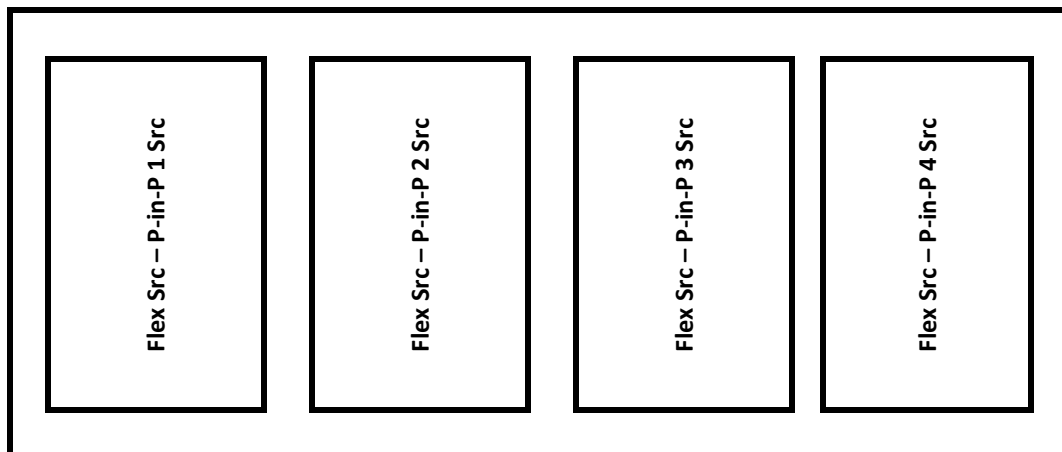

Preset 3

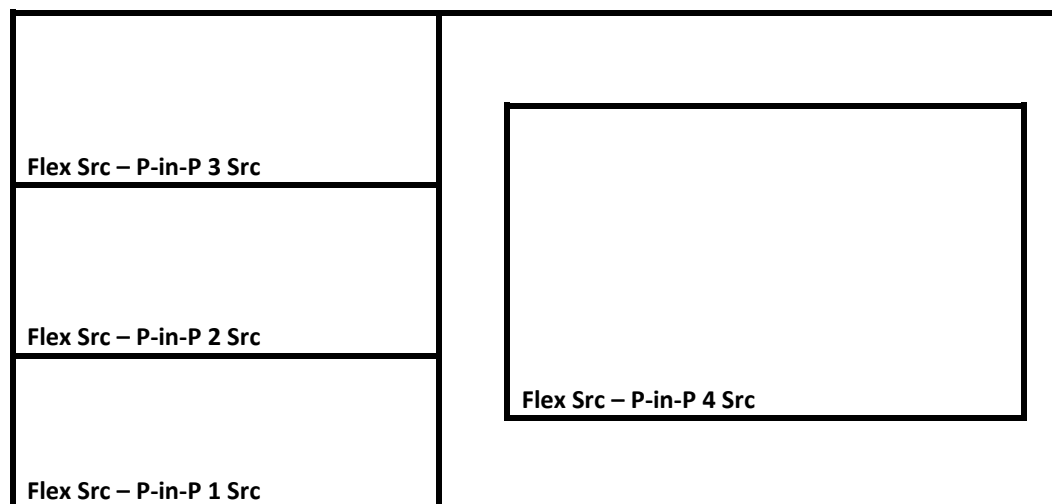

Note: Presets 4 to 6 are reserved for future developments.

Please note that positions of these PIP windows on the FLEX screen can be changed by adjusting the **x-y coordinates** in the **P-in-P** sub menu. In addition, the user is also allowed to adjust the size of the FLEX window, enable/disable the window's border, set the border color, and crop the window image.

After the FLEX source is properly configured, the user can activate **Flex Src 1** on either the Program or Preset screen by pressing the **SHIFT** key followed by the **3/FLEX** button (the button should illuminate blue) along the Program or Preview row.

Alternatively, you can also press the **BLK** button which should turn blue, then press the **3/FLEX** button to activate **Flex Src 1** (3/FLEX button flashing blue).

Note that the Flex Src window has an allowable size of up to 1080p full screen. If exceeded, one of the Flex Src windows will not be able to display the image correctly.

4.6 Inputs

This feature allows the user to select the mode of the selected input and then configure the input color by adjusting its **Black Level**, **White Clip** and **Chroma Gain** parameters. In addition, the Crosspoint function allows the user to shuffle contents of Inputs 1-8 without changing physical connections at the back of the machine.

Advanced/Basic mode

Inputs	Input	Input 8	Mode	Live	Mode	CG Md
		Zoom 100%	X	0%	Y	0%
	Proc Amp	Black 0%	White	100%	Chrom	1.0
	Audio	Gain 0 dB	Delay	0 ms		
	Crosspoint	Input 8				
	Audio XPT	Off				

Input

In this option, you will be allowed to set the mode of display in the respective Input windows of the Multiview display. First select the input that you would like to configure and then for each selected input, set the mode of input by selecting one of the modes **from the first mode option**:

- **Still** – Displays the still picture loaded into Inputs 1-8 in the respective input window.
- **Freeze** – Freezes the current video played in the Input window.
- **Live** – Live view or video display in the Input window.

Mode of Operation

The second mode option allows you to select the mode of operation upon connection of a CG image source to either of the HDMI inputs 5 – 8.

OFF: HDMI input channels are regular video input ports.

CG Mode: Enable CG mode to allow keying of CG text or graphics (1080p60/59.94/50) over the live video (4K/60/59.94/50/30/29.97/25 and 1080p/60/59.94/50/30/29.97/25) via the switcher’s HDMI input ports. See [Character Generator](#) for more detailed instructions.

Proc Amp

Proc Amp allows the user to configure the input color by adjusting its Black Level (0 – 100%), White Clip (0 – 100%) and Chroma Gain (0 – 16) parameters.

Audio

Gain (0 – 24 dB): adjustment of the input audio volume for a particular selected video input.

Delay (0 – 340 ms): sets the delay of the audio component of a particular selected video input.

Crosspoint

The crosspoint function allows the user to shuffle the contents of Inputs 1-8 without changing the physical connections at the back of the machine. For example, the user is allowed to assign the input 2 video source to input 1, after which the input 2 video will be displayed on the input 1 window. Select OFF if you would like to disable the input port.

- Input 1-8
- OFF

Audio XPT

The Audio XPT feature allows the user to associate the audio component of any input source to any of the input buttons (1 – 8), thus cross assigning audio input channels to program/preview row buttons. Available options are listed as follows:

- Input 1-8
- External
- Follow

“**External**” selects audio source from AUDIO IN ports.

Select “**Follow**” to set the audio to Audio-Follow-Video mode in which the PGM audio is played via **AUDIO OUT** port. Please note that there will be no audio delay.

4.7 Outputs

This option allows the user to configure various output settings such as video output, Tally mode and GPI connection.

Advanced mode

Outputs	Output	Sdi 1	Input 1	Sdi 2	Input 2	HDMI 1	Pgm
	Multiviewer	AutoNum	Off	Label Inf	Off	Trns Lab	Off
		MV1	Preset 3			L: PVW	R: PGM
	Tally Mode	Normal					

	GPI Out	Off	Mode	Pulse	Width	1
		Input 1	Delay	0		

Basic mode

Outputs	Output	Sdi 1	Input 1	Sdi 2	Input 2	HDMI 1	Pgm
	Multiviewer	AutoNum	Off	Label Inf	Off	Trns Lab	Off
		MV1	Preset 3			L: PGM	R: PVW

Outputs

In general, the HS-2600 offers 4 output ports (**SDI 1–3 / HDMI 1**) with SDI 1, SDI 2 and HDMI 1 being configurable to one of the following:

- Flex Src 1
- Still 2
- Still 1
- Input 1 – 8
- CLN PVW (Clean PVW)
- CLN PGM (Clean PGM)
- PG + DSK
- PVW
- PGM
- MultiV (Multi view)

Please note that SDI 3 is a Program Only video output port.

Multiviewer

AutoNum: The Multiview windows can be automatically numbered, and this option turns ON/OFF automatic numbering.

Label Inf turns ON/OFF Label information. Input label indicates whether the input is still (stl), live (*), or a frozen image (frz). **Please note that the label content cannot be modified.**

Trns Lab turns ON/OFF the Label Background Transparency. Once enabled, the background of the label should turn from an opaque black to a transparent one.

MV1

The HS-2600 Multi-view monitoring is available in different multi-image layouts. These outputs can be used to monitor video and audio in a number of different configurations. For each setup, embedded audio level indication is also available on all inputs as well as the Preview and Program windows.

Preset 1				Preset 2		
Preview		Program		Program		1
1	2	3	4	3		2
5	6	7	8	4		5
Preset 3						
Program		Preview				
1	2	3				
4	5	6				

R/L

On the Multiview, by default, Preview window is positioned on the left and on the right is the Program window. This option allows you to switch their positions.

Tally Mode

Tally output port generally sends two tally signals to each channel. In Datavideo products, **Red** indicates On-Air, and **Green** indicates next video source. On the Multiview screen, the tally light is indicated by rectangular borders around the input sub windows.

The HS-2600 provides two tally modes:

Normal: If in normal mode, tally lights of all video sources enabled on PGM view will be turned ON (**Red**). These sources include PGM, PIP and Key sources. While transition is in progress, tally lights of all video sources enabled on PGM view do not change color. The tally light will only change color (**Red → Green**) after transition of PGM and PVW views is complete. However, for video sources on the Preview window, the tally lights will be enabled **Green**, and the color is changed to **Red** as soon as the transition is triggered.

Audio Mixer: If Audio Mixer mode is selected, tally lights of all video sources enabled on PGM view will be turned ON (**Red**). While transition is in progress, tally lights of all video sources enabled on PGM view do not change color. The tally light will only change color (**Red → Green**) after transition of PGM and PVW views is complete. However, for video sources on the Preview window, the tally lights will be enabled **Green**, and the color is changed to **Red** as soon as the transition is triggered.

GPI Out

GPI is designed to allow the user to trigger playback of an external playback device such as Datavideo's HDR-80/90. **GPI OUT** allows the user to configure your GPI connection.

First enable the GPI port and then set the GPI **mode**, which is either level or pulse. The pulse width can be configured in **Width** sub-option (1-9).

Once the GPI function is enabled, you can assign it to one of **Inputs 1-8** which can later be used to trigger external devices and the **delay** can be set to a value between 0 and 99.

4.8 Audio

In the **Audio** menu, you will be able to start and shut off the embedded audio of **SDI** and **HDMI** videos.

Advanced/Basic mode

Audio	Audio	Mode	On	Src	Input 1	
	PGM Audio	Mode	V Fade	Gain	0 dB	Delay 0 ms
	Analog Out	Src	Follow	Gain	0 dB	Delay 0 ms

Audio

External audio source can only enter the HS-2600 via the analog XLR input port found on the rear panel of the main unit. Ideally the user should use the HS-2600 with an audio mixer.

It is recommended to use the AD-200 audio mixer designed and manufactured by Datavideo. All external audio sources can be connected to AD-200 before entering the HS-2600 (for delay purpose). The external audio can be embedded into SDI video out.

Mode (ON/OFF): Setting Mode ON allows the HS-2600 to embed external audio component into SDI video out. Changing the **Mode** option from ON to OFF will mute the embedded audio.

Audio Src: This sub-option allows the user to select the audio source.

If “**External**” is selected, the external audio, i.e. audio from **AUDIO IN** port, will be played.

If “**Follow**” is selected, the audio will enter Audio follow Video mode, i.e. playback of the audio of the output video.

To play the audio of a particular input video channel, select an **input number** from Input 1-8.

PGM Audio

Mode (V Fade/X Fade)

While working in the Audio-F-Video mode, the audio sources will also change as the video sources are switched. We can choose how the audio changes sources, whether it be a clean cut (immediate switch) or some sort of transitioned change (cross fade or fade out & in). To do this we would need to set up with the following menu options.

- **X Fade:** PGM Audio / PVW Audio cross fade
- **V Fade:** Fade out PGM Audio then fade in PVW Audio

Gain (0 – 24 dB): adjustment of the PGM audio volume.

Delay (0 – 340 ms): sets the delay of the PGM audio volume.

Analog Out

You are also allowed to select a source of audio of your preference and output the selected audio via Audio OUT. Open the OSD menu and select Audio → Analog Out → Src where you may select a source of audio from the following list.

- PGM Audio
- Follow
- Input 1-8

If “**Follow**” is selected, the audio will enter Audio follow Video mode, i.e. playback of the PGM audio via Audio OUT **without audio output delay**. If “**PGM Audio**” is selected, the HS-2600 will only play the PGM audio via Audio OUT **with audio output delay**. You may also select to output one audio component of the 8 inputs via Audio OUT **without audio output delay**.

Gain (-60 – 24 dB): adjustment of the audio volume at the **AUDIO OUT**.

Delay (0 – 340 ms): sets the delay of the audio at the **AUDIO OUT**.

4.9 Files

In Files, you will be allowed to manipulate different files such as clips, still pictures, user memories and still and animated logos.

Still allows the user to load images from the memory, save images to the memory, and save the images captured. **User** allows you to **load** previously saved settings and **save** the currently configured settings. In **Clip**, you will be able to browse through the clip files and load the clips directly on the switcher. As for logo and ani logo menus, they allow you to load still and animated logos directly on the switcher.

All five file types will be discussed in the following sub-sections.

User Mems

In this option, the user is allowed to **load** previously saved settings and **save** the currently configured settings.

Advanced/Basic mode

Files	User			
	Load Mem	Memory	1	Load
	Save Mem	Memory	1	Save

Load Memory

Use the up/down arrow to scroll to the desired memory location and load the saved setting by selecting “**Load**”.

Note: The user can also press one of the USER memory shortcut buttons (1-9) on the control panel as a quick way of loading those previously saved User configurations.

Save Memory

Use the up/down arrow to scroll to the desired memory location and save the current setting by selecting “Save.”

Still

STILL image is an image pre-loaded to the HS-2600’s input buffers (Input 1-8). The **Still** menu allows users to load still pictures from the machine’s internal memory to the input buffer, save still pictures to the machine’s internal memory, view thumbnail pictures and grab program image to the specified still memory locations.

Advanced/Basic mode

Files	File Type	Still		
	Load Still	Load	Still Num 1	Still 1
		Thumbnail Picture – 1	Thumbnail Picture	Thumbnail Picture + 1
	Save Still	Save	Still 1	Still Num 1
				Delete
	Grab Still	Grab	Still 1	

Load Still

Upon selecting “**Load Still**”, the user can then choose the memory location from which the still image is loaded. The system memory can store up to 500 still images. The following are the destinations to which the still image can be loaded:

- Still 1: Still 1 button
- Still 2: Still 2 button
- Input 8: Input button 8
- Input 7: Input button 7
- Input 6: Input button 6
- Input 5: Input button 5
- Input 4: Input button 4
- Input 3: Input button 3
- Input 2: Input button 2
- Input 1: Input button 1

Select “**Load**” to load the still image to the chosen destination.

Image Preview is available below the “**Load Still**” row. “**Thumbnail Picture – 1**” allows the user to preview the previous image, “**Thumbnail Picture**” displays the image that will be loaded when “**Load**” is selected, and “**Thumbnail Picture + 1**” shows the next image.

Note: The user is allowed to import still picture files. It is recommended to use 24-bit without Alpha bmp, png and jpg formats.

Save Still

“**Save Still**” allows the user to save the still image to a specific memory location. The user should determine the source of the still image first. The available sources are listed below:

- Still 1: Still 1 button
- Still 2: Still 2 button
- Input 8: Input button 8
- Input 7: Input button 7
- Input 6: Input button 6
- Input 5: Input button 5
- Input 4: Input button 4
- Input 3: Input button 3
- Input 2: Input button 2
- Input 1: Input button 1

To complete the save, the user can simply select “**Save**” after determining the memory location.

To remove a still from a memory location, first scroll to the memory location, and select “**Delete**” then “**Yes**” to confirm the delete.

Grab Still

“**Grab Still**” function grabs an instant of the video image on the Program view to the destinations listed as follows:

- Still 1: Still 1 button
- Still 2: Still 2 button

After determining the destination to which an instant of the video image is captured, simply select “**Grab**” to trigger the image grab.

In the following sections, we will show you how to import still images from the PC to the switcher and load the imported file to the switcher.

Loading still images

The HS-2600 allows the user to load still images saved on the machine to the Multiview screen. Please follow the steps outlined below to load the still picture.

1. Press the **MENU** button to open the OSD menu on the Multiview display.
2. Open the **Stills** menu option as shown below.

Files	File Type	Still		
	Load Still	Load	Still Num 1	Still 1
		Thumbnail Picture – 1	Thumbnail Picture	Thumbnail Picture + 1
	Save Still	Save	Still 1	Still Num 1
				Delete
	Grab Still	Grab	Still 1	

3. In the **Load Still** sub-option, first select the still picture that you would like to load (**Still Num**). The still picture preview is shown in the row right below the **Load Still** row.
4. In the field next to **Still Num**, select a destination to which the still picture will be loaded. Once the destination is determined, select **Load** to load the still picture to one of the following destinations:
 - Still 1: Still 1 button
 - Still 2: Still 2 button
 - Input 8: Input button 8
 - Input 7: Input button 7
 - Input 6: Input button 6
 - Input 5: Input button 5
 - Input 4: Input button 4
 - Input 3: Input button 3
 - Input 2: Input button 2
 - Input 1: Input button 1

For more still functions such as file import from the PC or laptop, see [Section 5.3 Managing Still Pictures](#).

Clip

The **CLIP** or Stinger Transition Effect is basically an animated effect added during transition of two video sources. The animated effect is generated by a clip file which consists of a series of sequential files in **bmp/jpg/png/pic** formats. In the next few sections, you will be shown how you can load the existing clip on the switcher, and import the clip to the switcher from the PC.

Advanced/Basic mode

Files	File Type	Clip		
	Load Clip	Load	Clip 0	Clip Settings
		Thumbnail Clip - 1	Thumbnail Clip	Thumbnail Clip + 1
		Clear Clip		Delete Clip

Load Clip

In this sub-option, use the Up/Down arrows on the physical keyboard of the switcher to browse the clip files. Once “Load” is pressed, the selected clip will be loaded into the clip buffer and replace the previously loaded clip. **As the clip is being loaded, you will be able to view its progress on the Preview window.**

Note: The HS-2600 comes with pre-loaded clip files. The HS-2600 also allows the user to import customized clip files. It is recommended to use 32-bit with Alpha png format.

You can preview three clip videos at the same time. “**Thumbnail Clip – 1**” allows the user to preview the previous clip, “**Thumbnail Clip**” displays the clip that will be loaded when “**Load**” is selected, and “**Thumbnail Clip + 1**” shows the next clip. **To enable the Clip (Stinger) transition mode, simply press the CLIP button.**

To clear the loaded clip from the buffer, simply select “**Clear Clip.**” To remove clip from a memory location, select “**Delete Clip.**”

Clip Settings

Clip Settings allow the user to set the Clip’s Start/End & Mid (Transition points) frames. After users have imported a clip, they often find that it needs some small adjustments so with these settings the user can skip unwanted frames at the start and end of the Clip. They can also choose the frame at which the fade from PGM to PVW occurs.

The default is to do the fade in the middle of the clip but depending on the actual clip, the user may want to alter this position.

- **Start Frm:** Adjusts the start frame number of the Clip
- **End Frm:** Adjusts the end frame number of the Clip
- **Mid Frm:** Adjusts the PGM to PVW fade point of the Clip
- **Cancel:** Cancels any changes
- **Save:** Saves the changes for this clip as each clip is allowed to have different settings.

Note: Clip Settings will be enabled only after the clip is loaded.

Loading the existing Clip for Stinger Transition Effect

The HS-2600 allows you to generate the stinger transition effect. To do this, the user should load the clip saved on the machine first. Follow the steps outlined below to load the clip.

1. Press the **MENU** button to open the OSD menu on the Multiview display.
2. Open the **Clip** menu option as shown below.

Files	File Type	Clip		
	Load Clip	Load	Clip 0	Clip Settings
		Thumbnail Clip - 1	Thumbnail Clip	Thumbnail Clip + 1
		Clear Clip		Delete Clip

3. In the **Load Clip** option, first select the clip that you would like to load. The **Clip Preview** is shown in the row right below the Load Clip row.
4. Select **Load** to load the clip. The load progress prompt “**Loading Clip XX/XX ...**” will appear on the Preview window. Once loaded to the clip buffer, the previously loaded clip will be replaced.

Note: The load process can take up to tens of seconds.

5. To enable the Clip or Stinger transition mode, simply press the **CLIP** button.

For more information about Stinger transition (importing clip files to the switcher), see [Chapter 5.4 Performing a Stinger Transition.](#)

Logo

Logo is a still image pre-loaded to the logo buffer (Logo 1/2). The **Logo** menu allows users to load logo pictures from the machine’s internal memory to the logo buffer, save logo pictures

to the machine’s internal memory, view thumbnail logo pictures and adjust the logo positions.

Advanced/Basic mode

Files	File Type	Logo		
	Load Logo	Load	Logo	1
		Thumbnail Picture – 1	Thumbnail Picture	Thumbnail Picture + 1
		Clear Logo		Delete Logo
	Logo 1	X	-37%	X 24%
	Logo 2	Y	0%	Y 0%

Load Logo

Upon selecting “**Load Logo**”, the user can then choose the memory location from which the still logo image is loaded. The system memory can store up to 999 still logo images.

Logo Preview is available below the “**Load Logo**” row. “**Thumbnail Picture – 1**” allows the user to preview the previous logo, “**Thumbnail Picture**” displays the logo that will be loaded when “**Load**” is selected, and “**Thumbnail Picture + 1**” shows the next logo.

Select “**Load**” to load the logo to the chosen destination (Logo 1/Logo 2).

Note: To import custom logos from your computer, see [Chapter 5.5 Enabling Still Logo](#) for instructions.

To clear the loaded logo from the buffer, simply select “**Clear Logo.**”

To remove a still logo from a memory location, first move to the memory location, and select “**Delete**” then “**Yes**” to confirm the delete.

Positioning

The logo can be manually positioned by adjusting its XY coordinates. Note that the origin of the coordinate system is at the center of the screen.

X: A positive value indicates that the logo is in the right half of the screen and a negative value indicates that the logo is in the left half of the screen.

Y: A positive value indicates that the logo is in the top half of the screen and a negative value indicates that the logo is in the bottom half of the screen.

Ani Logo

Ani Logo is an animated logo pre-loaded to the logo buffer (Logo 1/2). The **Ani Logo** menu allows users to load animated logo from the machine’s internal memory to the logo buffer, save animated logo to the machine’s internal memory, view thumbnail images and adjust logo position.

Advanced/Basic mode

Files	File Type	Ani Logo		
	Load Ani Logo	Load	Ani Logo	1
				Logo 1

		Thumbnail Picture – 1		Thumbnail Picture		Thumbnail Picture + 1	
		Clear Ani Logo				Delete Ani Logo	
	Logo 1	X	-37%	X	24%		
	Logo 2	Y	0%	Y	0%		

Load Ani Logo

Upon selecting “**Load Ani Logo**”, the user can then choose the memory location from which the animated logo is loaded. The system memory can store up to 999 logo animations.

Logo Preview is available below the “**Load Ani Logo**” row. “**Thumbnail Logo – 1**” allows the user to preview the previous animated logo, “**Thumbnail Logo**” displays the logo animation that will be loaded when “**Load**” is selected, and “**Thumbnail Logo + 1**” shows the next animated logo.

Select “**Load**” to load the animated logo to the chosen destination (Logo 1/Logo 2).

Note: To import custom logo animations from your computer, see [Chapter 5.6 Enabling Logo Animation](#) for instructions.

To clear the loaded logo animation from the buffer, simply select “**Clear Ani Logo.**”

To remove an animated logo from a memory location, first move to the memory location, and select “**Delete**” then “**Yes**” to confirm the delete.

Positioning

The animated logo can be manually positioned by adjusting its XY coordinates. Note that the origin of the coordinate system is at the center of the screen.

X: A positive value indicates that the animated logo is in the right half of the screen and a negative value indicates that the animated logo is in the left half of the screen.

Y: A positive value indicates that the animated logo is in the top half of the screen and a negative value indicates that the animated logo is in the bottom half of the screen.

4.10 Setup

In the “**Setup**” menu, the user can change the **resolution**, switch between full and simplified menu versions, reset the HS-2600 to its **Factory Default** values, adjust the **menu preferences**, enable/disable **Auto Save**, choose the preferred OSD menu **language**, **upgrade firmware** and view the **current firmware versions** (Interface, Mainboard and Keyboard).

Advanced/Basic mode

Setup	Standard	1080p/59.94	Level	Auto	Save Setup
	Genlock	Off	H Phase	0	V Phase 0
	Menu Mode	Advanced	Brightness	3	
	Menu Pref	Blue	Transp	1	Position Bot
	Auto Save	On			
	Factory Def	Restore	Restr Names		
	Language	English			

		Network	Network Def	
	HS-2600	s/w: v0.9.9.9	f/w: 2019-07-17	Kbd: v1.7.3 OS: v1.0

Addr Mode	DHCP			
IP Addr	192	168	100	101
Network Mask	255	255	255	0
		Cancel	Save	

Standard

This option allows the user to choose the appropriate output resolution such as 1080i/50. Once done, simply select “Save” to confirm the selected output resolution. The available resolutions are 1080p/60/59.94/50, 1080i/60/59.94/50, and 720p/60/59.94/50.

Note: If you select 720p as the output resolution, all inputs must also be set to 720p.

Level

There are two different audio standards available for selection. The user can either select the EBU or SMPTE standard. By selecting AUTO allows the device to automatically detect the audio standard.

Note: When the image is 50 Hz, the audio follows EBU standard and when the image is 59.94/60 Hz, the audio follows SMPTE standard.

Genlock

Genlock is an external sync setting. **Ref IN/OUT** port receives external sync which can be either **Tri-Level** or **Black Burst** signal. **Please note that resolutions of 1080i and 720p are not appropriate for Black Burst Sync.**

Enable genlock to allow the switcher to receive external sync, then adjust its H and V phases accordingly. H phase ranges from -2190 to +2190 ms and V phase ranges between -1124 and +1124. A positive value sets sync signal leading and a negative value sets sync signal lagging.

Menu Mode

The user is allowed to switch between full and simplified menu versions. Select “Advanced” for full menu display or “Basic” to display a condensed version of the OSD menu.

Brightness: This option allows you to adjust the keyboard brightness with 7 being the brightest and 1 being the dimmest.

Menu Preference

In menu preference, the user is allowed to set the menu color, menu transparency level, menu size and the display position.

Menu color: the available options are blue and grey

Options of **Menu Transparency** are listed below:

- 0: No Transparency
- 1: Background 50% Transparent (buttons not Transparent)
- 2: All Menu 50% Transparent

Menu Position

Menu Position gives the user ability to select several positions for the Menu area on the Screen. The current options are Centre, Top, Left, Right and Bottom.

Auto Save

When enabled, the **Auto Save** function will automatically save your last settings 5–10 seconds after closing the OSD menu. During this period, do not shut down the machine. At the next boot, the machine will load the last saved settings.

Notes:

- **Still Load** also triggers **Auto Save**.
- The **Auto Save** function does not save settings instantly; it activates 5–10 seconds after the OSD menu is closed to ensure smooth operation.
- **Auto Save** does not apply to the resolution setting. After changing the HS-2600's output resolution in "**OSD Menu > Setup > Standard**", remember to select "**Save Setup**" to save the new resolution.

Factory Default

Restore: This option resets the machine to the factory default settings.

Reset Names: This resets the Multiviewer labels (Input 1-8) to their default settings.

Language

The available languages for OSD menu are English, Traditional Chinese and Simplified Chinese.

Network

The Network option allows you to view the switcher's IP address through which the computer imports image files. See [Chapter 3](#) for software installation and [Section 2.2](#) for network configuration.

Addr Mode: The available network connection modes are **DHCP** and **Static**. The default connection mode is **Static** with an IP address of **192.168.100.101**.

IP Addr: Manually enter the IP address if **Static** is chosen.

Network Mask: Manually enter the network mask if **Static** is chosen.

Cancel: Select to cancel all changes made.

Save: Select to save all changes made.

Network Def: resets network settings to factory defaults. Default settings are listed below.

- Addr: Static
- IP Addr: 192.168.100.101
- Network Mask: 255.255.255.0

Software

This option is only available when the USB storage device containing the latest firmware file is inserted. Select **Upgrade** to start the firmware upgrade process. Refer to the [FIRMWARE UPGRADE](#) section for more details.

At the bottom of the menu, you will be able to view the version number of the latest firmware installed.

Chapter 5. Basic Operation

The switcher's control panel is the main control interface for the user to select video sources and take them to air during live production. On the control panel, the user will be allowed to select the transition style, enable/disable various keyers, and add logos to the program view.

The OSD menu allows the user to adjust transition settings, configure chroma keyers and PIP windows, assign inputs and outputs and modify audio parameters.

This section describes how you can switch video sources on the control panel using simple operations.

5.1 Video Switching

First let's learn the basics of video switching.

Program and Preview rows

This row of buttons is typically used to select the switcher's main Program output image. The selected source sent to the Program outputs will be **backlit Red** on this row. Simple cuts between sources can be performed on this row by pressing the source number required for the next shot.

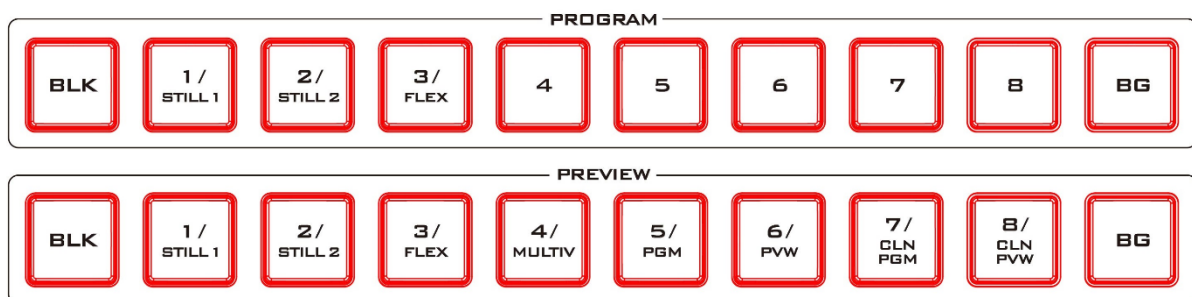

This row of buttons is typically used to select the switcher's Preview or Next source output image. The selected source will be **backlit Green** on this row. You can transition between Preview and Program using the **T-Bar**, the **CUT** button or the **AUTO** button.

Note: The keys on the Program and Preview rows will still be active while the T-Bar is moving.

Black and MATTE View



The **BLK** and **BG** buttons allow the user to respectively enable a black background and a matte colour on Program and Preview screens.

The MATTE color can be configured in the OSD menu. Simply go to 'Start' → 'Matte' and then adjust **Luma**, **Saturation** and **Hue**.

For **Hue** value, **Red** is 0, **Green** is approximately 120 and **Blue** is approximately 240. For secondary colors, **Yellow** is approximately 60, **Cyan** is approximately 180 and **Violet** is approximately 300.

The **Sat** or **Saturation value** refers to the intensity of the color selected in **Hue**. As the saturation increases, the color appears to be more pure. As the saturation decreases, the color appears to be more washed-out or pale.

The **Luma value** relates to how bright or dark the selected color or hue is. The higher the **Luma** value, the brighter the color selected in **Hue**.

Flex Output



The **Flex™** output allows the user to show a variety of sources at the same time these can then be fed as one combined image to the HS-2600 Program or Preview output.

The **Flex™** output is basically a combination of one background image and four other Picture in Picture windows. While pressing and holding down the **SHIFT** button, press the **FLEX** button to activate the **Flex™** output. To deactivate, press the **FLEX** button again.

You will have the ability to place a user defined color border around the smaller PIP windows. You can re-size, crop, rotate and position the PIP windows in almost any manner that you wish. See [Section 4.5 Flex Src](#) for more details about Flex Output Configurations.

Still button



While pressing and holding down the **SHIFT** button, press the **STILL** button to switch the Preview/Main Program view to a still picture.

Before pressing the Still button, make sure the still pictures are loaded to the still buffers (Still 1/2), which can be done in the **OSD** menu.

Tip: The still buffers can be used to store the image captured using the Grab button. See [Grabbing & Saving a Still to Memory](#) for detailed instructions.

5.2 Transitions

The **Transitions** group of buttons allows the user to decide how to bring the selected Preview source image to the Program output. The HS-2600 user can decide to use a **CUT**, **MIX**, **WIPE** or **DVE (Digital Video Effect)** transition. In order to use these transition options, the **TRANS BG** (Transition Background) button needs to be enabled (backlit Red).



AUTO Button



The **AUTO** button is used instead of the manually operated **T-Bar** and automatically performs the complete selected transition between Program and Preset over a set period. The **M/E** value in the **START** menu is used here. See [Section 4.1](#).

CUT Button



The **CUT** button is used to immediately switch between the currently selected Program and Preset sources.

MIX Button



The **MIX** button is selected when a dissolve or fade transition between the selected Program and Preset sources is required. This **MIX** transition is produced by then moving the **T-Bar** manually or by pressing the **AUTO** button. To configure the mix transition time, open the OSD menu, then the **Start** menu, and modify the **M/E** value accordingly.

**Program View
Before Transition**



**Transition in Progress
(MIX Effect)**



**Program View
After Transition**



WIPE/DVE Button



The **WIPE/DVE** button is selected when a 2D wipe or a 3D DVE transition between the selected Program and Preset sources is required. This WIPE or DVE transition effect is produced by then moving the **T-Bar** manually or by pressing the **AUTO** button.

Select 2D WIPE in **OSD menu** → **Start** → **WIPE Effects** → **WIPE**. Select 3D WIPE by pressing **DVE 1/2/3** buttons.

**Program View
Before Transition**



**Transition in Progress
(WIPE Effect)**



**Program View
After Transition**



WIPE/DVE Selection Pane

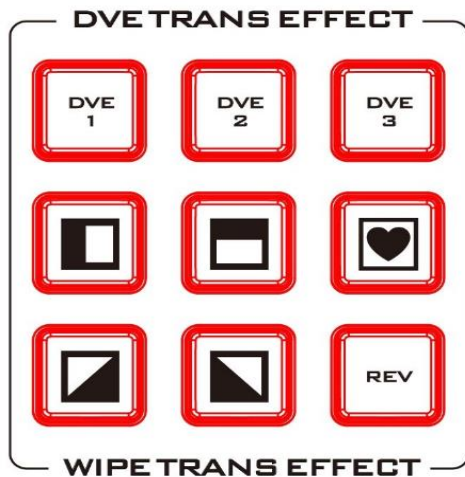

There are 32 different 2D WIPE effects and 3 different 3D WIPE effects to choose from when using the HS-2600 switcher. To select a different WIPE transition, either select a WIPE style in the **TRANS EFFECT** area of the HS-2600 Control Panel or the **Start** Item of the OSD Menu (see the table below). Before you make the selection, make sure the **TRANS BG** and **WIPE/DVE** buttons are enabled.

Start	Transition	M/E 60	DSK 15	FTB 60
	Type	WIPE		
	Wipe Effects	Wipe 1	Soft 0%	Width 1%
	Border	Luma 100%	Sat 80%	Hue 0
	Position	X 0%	Y 0%	
	Matte	Luma 100%	Sat 80%	Hue 0

Note: Open the **OSD menu** by pressing the **MENU** button on the HS-2600 Control Panel.

To select a **WIPE** on the **OSD menu**, navigate to the **WIPE** option under **WIPE EFFECTS** and then select a **WIPE number**. Each WIPE transition also has flexible user options to tailor the look of the transition. All wipes have an optional colour border applied. The wipe border **width** and **colour** are also chosen within the menu system.

Soft Value

This value allows the 'inside' and 'outside' edge softness of the Wipe Border to be controlled. A low value makes a sharp or hard wipe edge. A large value results in a softer or diffused wipe edge.

Width Value

This value determines how wide the actual wipe effect is. A low value makes a narrow wipe. A large value makes a wider wipe.

Hue, Sat and Luma values

The colour of the Wipe Border Matte can also be controlled by adjusting the **Hue**, **Sat** and **Luma** values.

Wipe Position

Certain Wipes, such as the **Circle** and the **Oval Wipes**, allow the Wipe position to be controlled.

The **X value** allows the selected wipe to be offset to the left or right of the screen.

The **Y value** allows the selected wipe to be offset to the top or bottom of the screen.

REV Button



When the **REV** Button is **OFF** the selected WIPE or DVE transition will operate in its default direction only. When the **REV** Button is **ON** then the selected transition will operate in the reverse direction.

Clip Button



Press the **Clip** button to enable the Clip (Stinger) transition mode.

The Stinger Transition Effect is basically an animated effect added during transition of two video sources. The animated effect is generated by a clip file which consists of a series of sequential files in **bmp/jpg/png/pic** formats. The

Stinger transition is produced by then moving the **T-Bar** manually or by pressing the **AUTO TRANS** button. See [Section 5.4](#) for instructions on loading the clip on the switcher.

Trans BG



Turning on the **TRANS BG** button allows you to activate the MIX, WIPE or Stinger transition with the background image/video.

When on (backlit red), the background image/video will be included in any chosen transition from Preview to Program. When this button is toggled, or switched off, any Keyer transition chosen will not change the background Program image/video.

Trans PVW



It is possible to see or test the effect of a chosen **MIX**, **WIPE** or **Stinger** transition on the Preview Monitor before using it on the Program output.

Once the **TRANS PVW** button is ON, select and use the transition that you want to test on the Preview monitor. You will also notice that the Preview Monitor switches to the currently selected Program source when the **TRANS PVW** button is turned on. Do not worry, the chosen Preview source has not changed. Press the **AUTO** button or move the **T-Bar** manually to preview the chosen transition.

NOTE: Remember to turn off the TRANS PVW button before attempting to use the chosen transition on the Program output.

FTB Button



The **FTB** button (Fade To Black) fades the current video program source to black. When pressed again it acts in reverse from complete black to the currently selected program video source. To set the transition time, open the OSD menu, then the Start menu, and modify the FTB value accordingly.

T-Bar

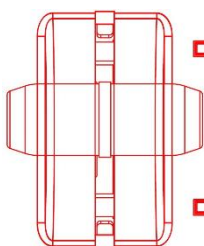

- This performs a manually controlled transition from the current program source to the selected preset source. The selected transition wipe, dissolve or animation will be used. When the **T-Bar** has travelled as far as it can go, the transition between sources is complete. Please note that
- the **T-Bar** can be operated bi-directionally.

The **T-Bar** has indicators next to it, which light when the transition is in progress indicating the direction of operation and is off after the transition is complete.

5.3 Managing Still Pictures

On the HS-2600 Switcher, the user will be allowed to manipulate uncompressed still pictures with Grab and Frame Store functions. In this section, you will also be guided to load the stills saved on the switcher and display them on the monitor.

Each video channel of the HS-2600 has one frame store to which a still can be loaded, and the unit has enough storage space for up to 1000 uncompressed stills.

Grabbing & Saving a Still to Memory

The Grab & Save options of the OSD menu allow new Still Images to be created by grabbing & saving the **current Program video frame image** to two internal still buffers in the HS-2600.

1. Press the **MENU** button to open the OSD menu (shown below) on the Multiview display.

Stills	File Type	Still		
	Load Still	Load	Still Num 1	Still 1
		Thumbnail Picture – 1	Thumbnail Picture	Thumbnail Picture + 1
	Save Still	Save	Still 1	Still Num 1
				Delete
	Grab Still	Grab	Still 1	

2. Grab the Program output to a selected Still buffer (Still 1 or 2) by selecting '**Grab**' or pressing the Grab button.



Please note that you can also use the **Still** buttons on the control panel to select the Still buffer. Simply press and hold down the **SHIFT** button then press one of the **Still** buttons which are **Channel 1/2** buttons along the Program or Preview row of buttons.

3. The user can look at the Multi Image Preview and decide if this Still should be saved.

4. To save a Still from the currently selected Stills buffer, the user should select a Still number that has not been used yet, and select '**Save**'.

5. The save process takes about 15 seconds, after which the new thumbnail picture will be shown within the Still display under the chosen still number.

Loading an existing Still from Memory

The Still Load Menu allows stills already stored in the HS-2600 to be loaded to a Still buffer (Still 1 or 2) or an Input buffer (Inputs 1 – 8). Follow the steps below to load the still.

Files	File Type	Still		
	Load Still	Load	Still Num 10	Still 1
		Thumbnail Picture – 1	Thumbnail Picture	Thumbnail Picture + 1
	Save Still	Save	Still 1	Still Num 10
				Delete
	Grab Still	Grab	Still 1	

The Still menu screen (shown above) shows thumbnail pictures of up to 3 saved stills at a time. If there are more than 3 stills stored in the HS-2600 then the Menu Control's up/down arrow buttons can be used to move through the saved stills. The stills are shown in numerical order, and any numbers not used will be blank.

To load a still, simply browse to a Still number and select a still buffer then select 'Load'. The selected still will be loaded into the selected buffer. In the above example, the still buffer will be loaded with the image in memory slot 10.

Deleting a saved Still from Memory

To delete a saved still, select a still number that is no longer required. Select 'Delete' and you will be prompted to confirm the delete. Select 'YES' to remove the still from the switcher's memory and 'No' to cancel the delete.

Note: The deleted still, if pre-loaded to the current Still or Input buffer, will be kept until another still image is selected or grabbed to occupy this buffer.

FS – Frame Store Button



The HS-2600 has eight video channels and each of these channels has its own Frame Store, making a total of eight Frame Stores. Each of these Frame Stores can hold one still image. The FS button allows the user to call the still image into the production and toggle between that still image of the Frame Store and the live video input connected to that same video channel.

How to choose live video input or Frame Store

1. First press the FS button and the Preview row of input sources will flash green.
2. Press the required input on the Preview row. For example, pressing button 1 switches the video channel to the still picture mode.
3. To return to the live video mode, simply press the channel button again.

This selection will also be confirmed on the Multi-view output, with the selected channel showing the live input or frame store image.

Note: Before using the FS function, first make sure the still picture has been loaded to the input video channel. Refer to the section on [Loading an existing Still from Memory](#) for instructions on loading still pictures.

Import Still Images from PC

The Switcher Image Import/Export software (**SwitcherImageImEx_vx.x.x.msi**) allows the user to import still pictures from the PC to a designated Still number in the switcher. **The software installation package can be downloaded from the product page.** Features of the Import/Export software are listed as follows:

- Supported file formats are BMP, JPG, PNG, and PIC.
- Minimum resolution is 1280 x 720.

See [Chapter 3](#) for software installation and [Section 2.2](#) for network configuration.

How to use

1. After the utility is successfully installed, double click the icon to run the program. Since the program is executed for the first time, it will automatically scan the network and if multiple network interface cards are found, simply select the card that is on the same network as the device.

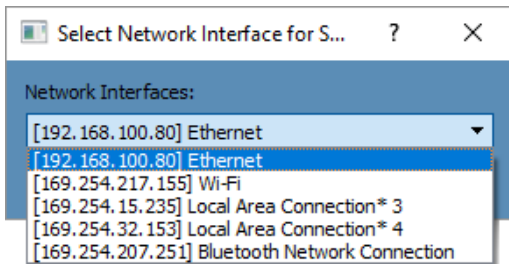

2. If the available device is scanned and found, the connection will be automatically established and the **Connect Status** will show “**Connected**” (will show **Not Connected** if disconnected).

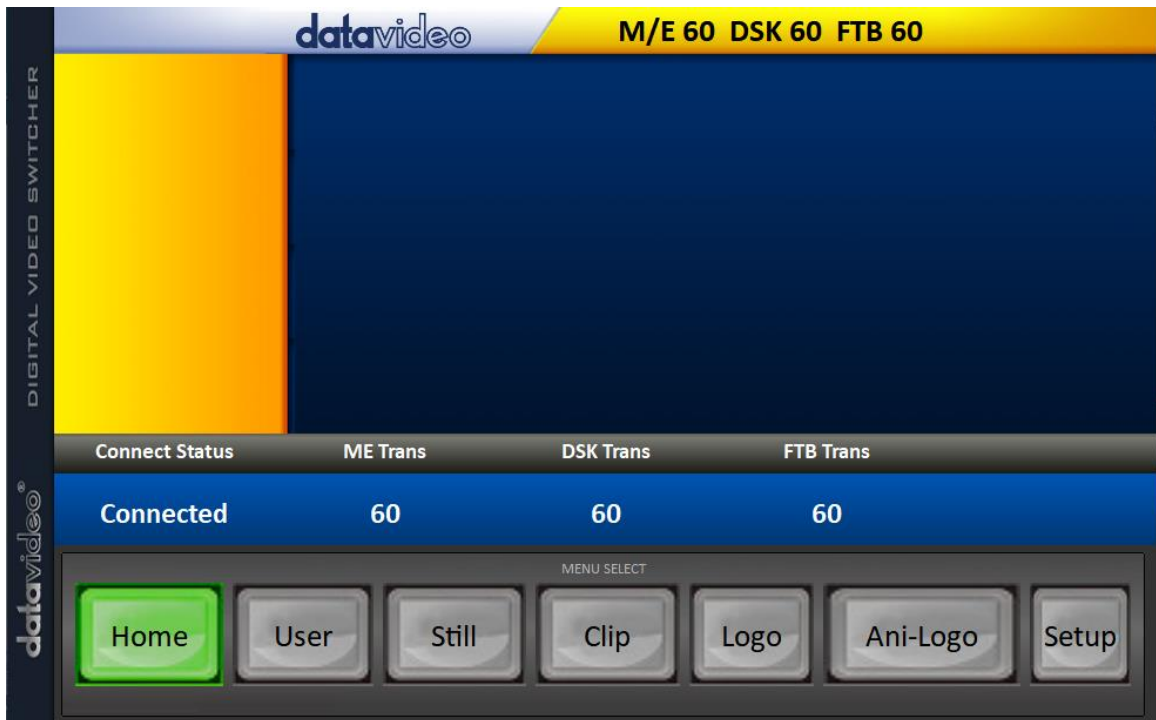

3. After clicking the **Setup** button, you will see the network information as shown below.

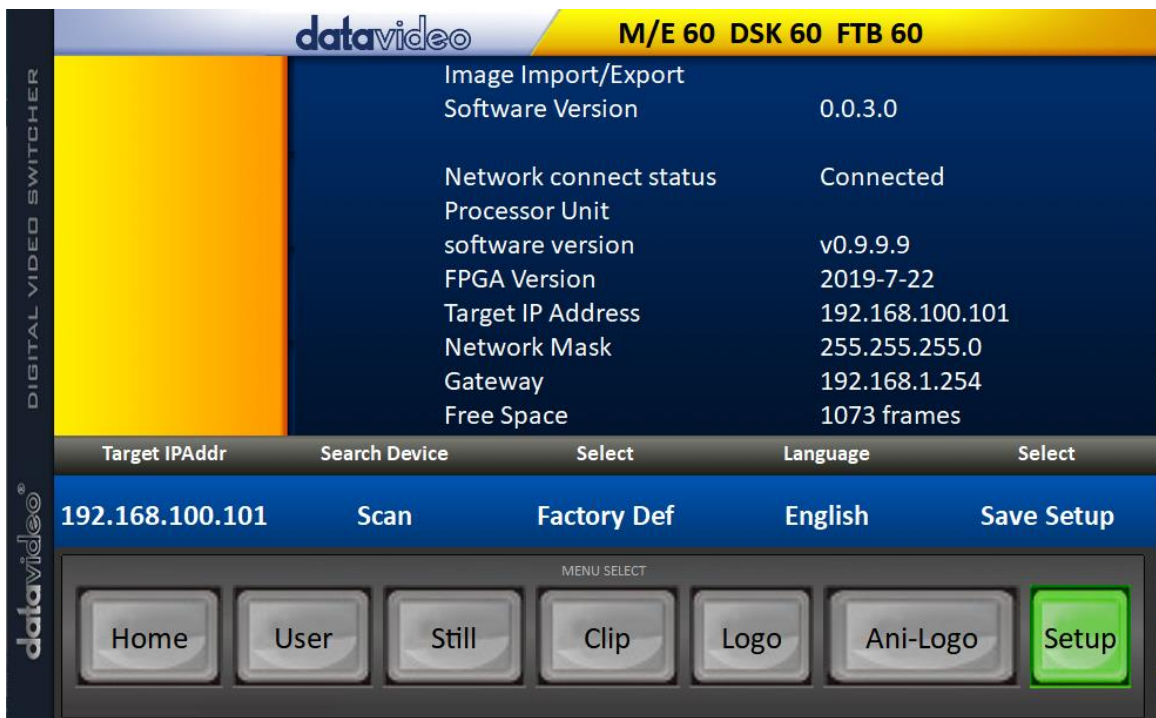

- Click the Still button to view thumbnails of still pictures and import still pictures from your PC.



- Click the Still number first and enter a location for storing the still. Then click Import Still and the interface for selecting still files will appear. If the selected picture is not 1120x1080 or 1280x720, the interface shown below will pop up to allow you to crop or zoom in/out the picture.

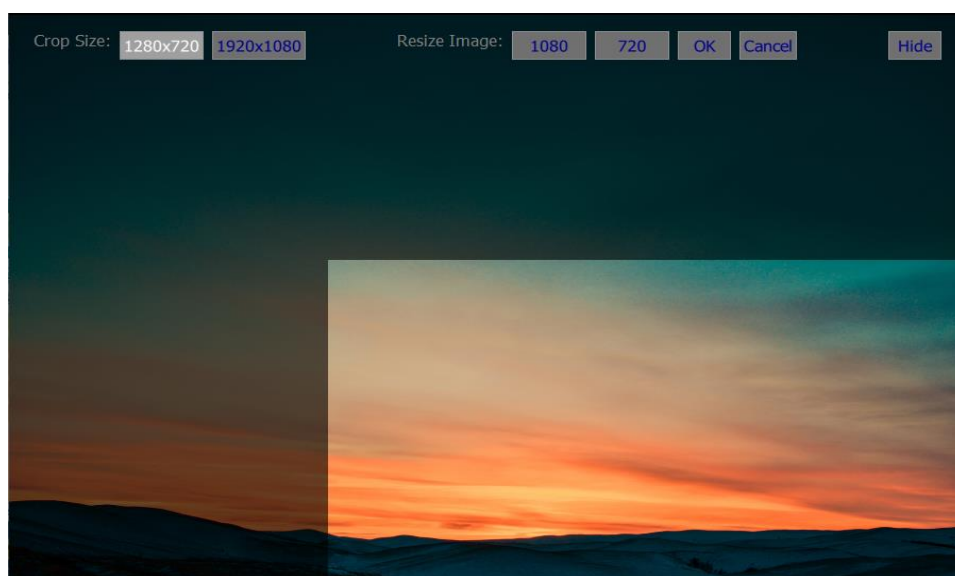

Crop Size: Select the right crop

Resize Image: You will be allowed to select two sizes, large (1080) or small (720), and zoom the picture to 1920 x 1080 or 1280 x 720.

OK: Apply the crop and start the import.

Cancel: Cancel the selection

Hide: Hide the interface

6. After the right crop is selected or the resolution is correctly configured, click OK to start importing the still picture to the switcher.
7. To confirm that the still picture is imported successfully, click the **Still** button on the **MENU SELECT** pane to view the thumbnails. OSD menu is another way to confirm the import, simply go to Files → File Type → Still.



5.4 Performing a Stinger Transition



The Stinger Transition Effect is basically an animated effect added during transition of two video sources. The animated effect is generated by a clip which consists of a series of sequential files in **bmp, jpg, png or pic** format. This type of transition is very popular in sports productions for transitioning in and out of instant replays.

In this section, we will explain how to build and perform stinger transitions.

Loading a Clip from Memory

In **Clip**, use the Up/Down arrow buttons on the physical keyboard of the switcher to browse the clip files. Once “**Load**” is pressed, the selected clip will be loaded into the clip buffer and replace the previously loaded clip.

Files	File Type	Clip		
	Load Clip	Load	Clip 0	Clip Settings
		Thumbnail Clip - 1	Thumbnail Clip	Thumbnail Clip + 1
		Clear Clip		Delete Clip

Note: The HS-2600 comes with pre-loaded clip files. The HS-2600 also allows the user to import customized clip files. It is recommended to use 32-bit with Alpha png format.

Preview of clip videos is below the “**Load Clip**” sub-option. You can preview three clip videos at the same time.

To enable **Clip (Stinger)** transition mode, simply turn **ON** the **Clip** button.

Importing the Clip for Stinger Transition Effect from PC

On the HS-2600, besides using the existing clips on the machine, you are also allowed to import your own clip (a series of **bmp/png/jpg/pic** files) to the HS-2600 from the PC using the **Switcher Image Import/Export utility**. Simply select one of the sequential files numbered by the last five digits of the file name and the utility program will start linking all images (from the first selected file to the last) up into a sequential animation file. The optimal resolution is 1920x1080.

Instructions for importing the clips are provided below:

Click the **Clip** button on the **MENU SELECT** pane.

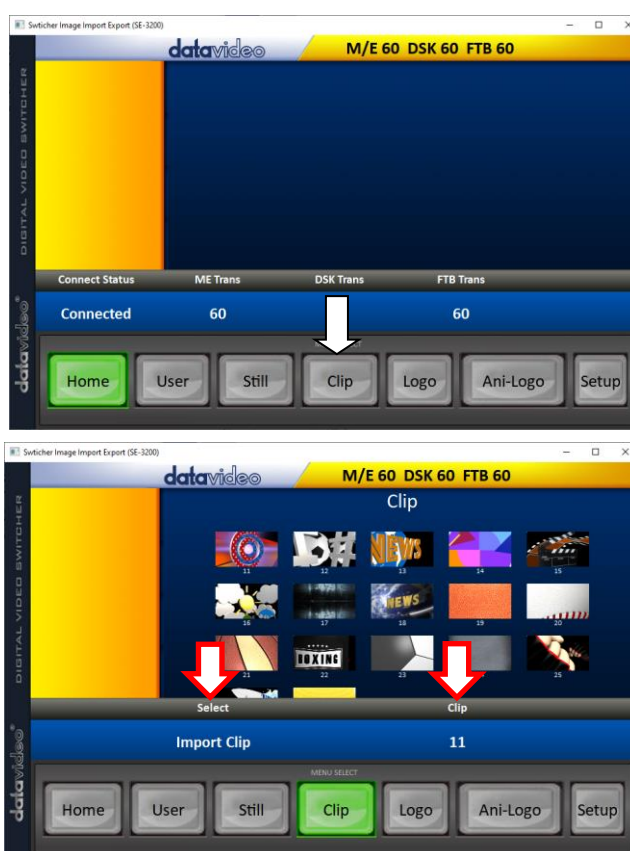

The clip number allows you to select a location where you can save the clip. To import a clip from the computer into the HS-2600, select **Import Clip**.

Tip: The **Switcher Image Import/Export utility** does the conversion from **bmp/png/jpg** to the **.pic** file format automatically. All you need to do is to give the utility a starting file location and it will give the utility an idea where to start linking all images up into a sequential animation file.

Importing Clips

Select “**Import Clip**” will open a file browser window. Browse to the directory where your clip files are saved and then select the file at the zeroth location, in our example on the right, the file name is **frame-000.png**.

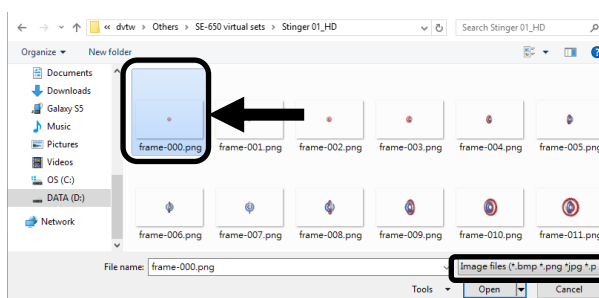

Click **Open** to start the clip import. If your files are not the .pic format, they will be automatically converted to .pic format by the **Switcher Image Import/Export utility** first.

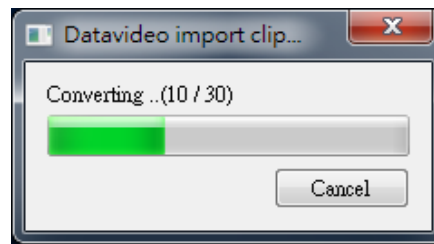

After the file conversion, the clip import will then start. After the import is complete, the progress dialog will be automatically closed.

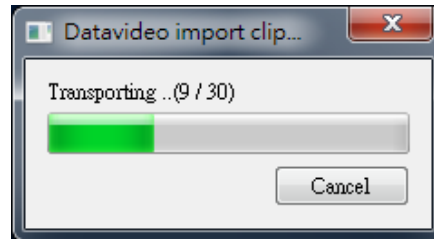

Note: Clip Conversion and Clip Import have progress dialogs that show progress & number of frames done. These dialogs also have a cancel button which allows the user to cancel the import at any stage. If the import is cancelled, then the partially imported data will be deleted.

How to Create the PNG Sequence for Stinger Transition Effect

Adobe After Effects is a motion graphics application that can be used for creating the clip file for stinger transition effect. After the clip file is created, there are two ways to convert the file to the PNG sequence format readable by the HS-2600 switcher in Adobe After Effects. In this section, we will show you how you can create the PNG sequence for the Stinger transition effect.

Adobe After Effects

1. Click **File** → **Export** → **Add to Render Queue** (or alternatively, you can also click **Composition** → **Add to Render Queue**).



2. The Render Queue will be displayed in the bottom pane.

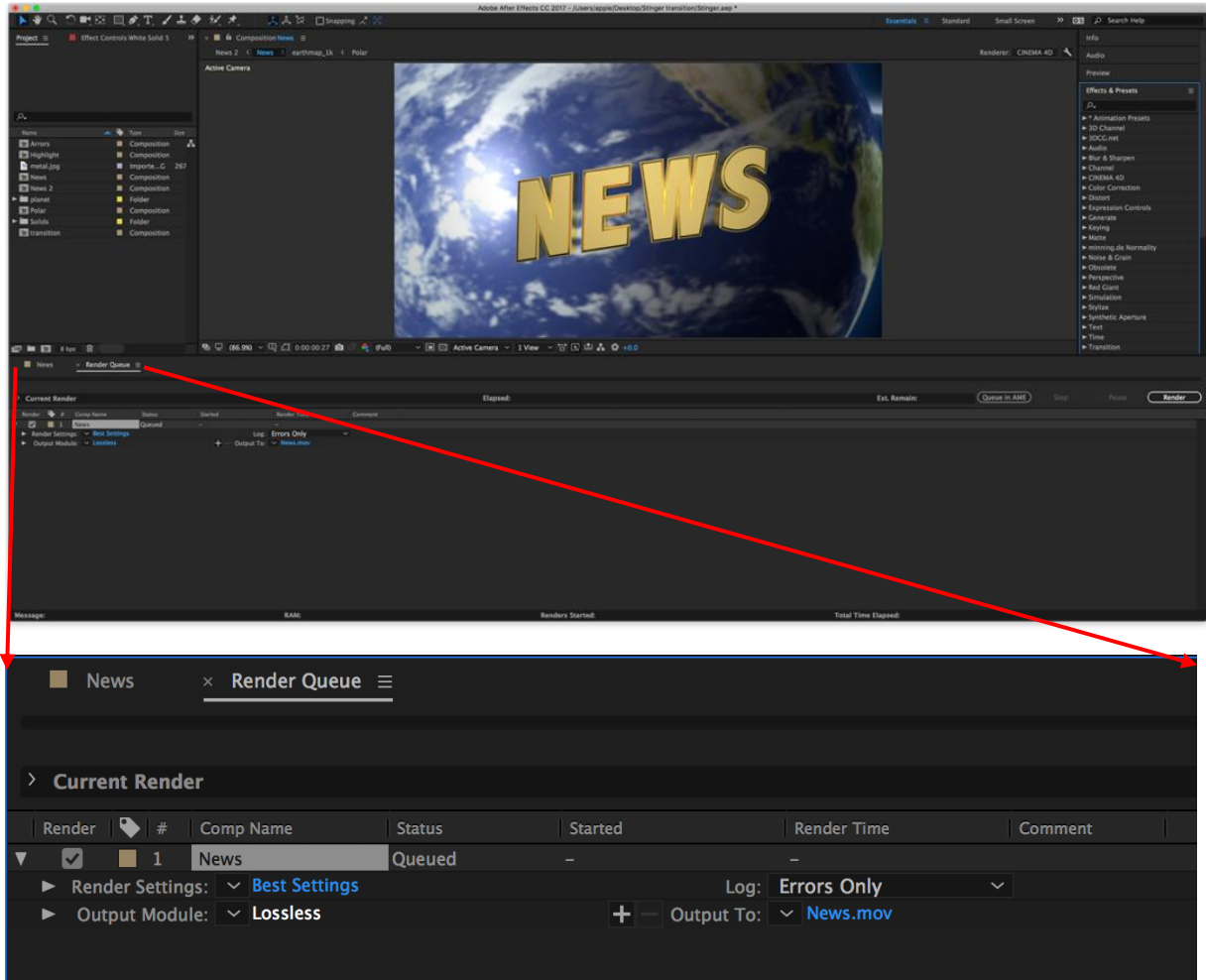

3. Click **Output Module** and on the **Main Options** window, click the **Format** dropdown list and select **PNG Sequence**.

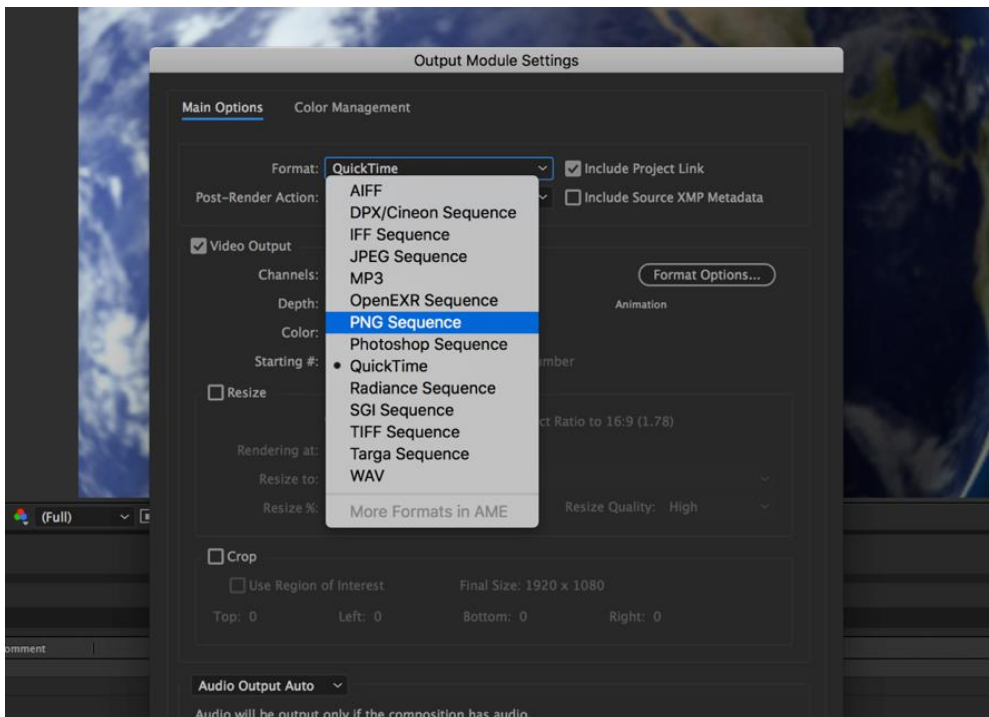

4. Click the **Channels** dropdown list and select the “**RGB + Alpha**” option.

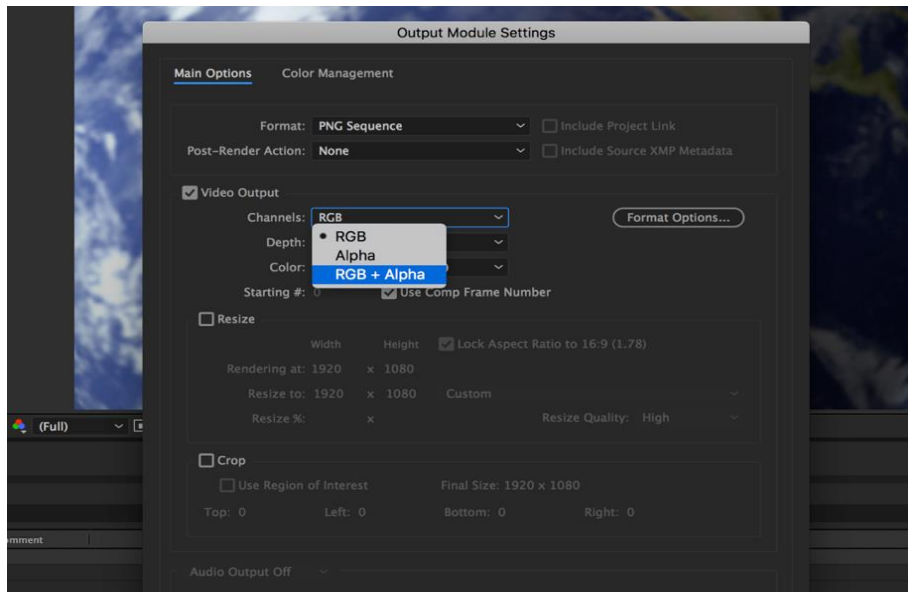

5. Click “**Output To**” and then change the location where your files are rendered. Click **Render** after that.

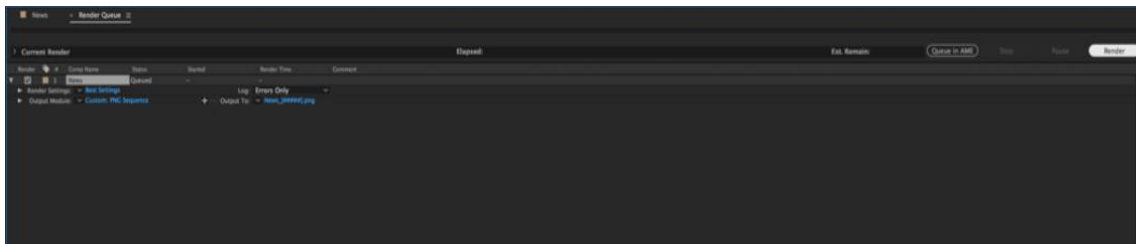

The next section outlines the file conversion procedure using the **Media Encoder CC**.

Adobe Media Encoder CC

1. Click **Composition** → **Add to Media Encoder Queue** (or alternatively, you can also click **File** → **Export** → **Add to Media Encoder Queue**).



2. Click blue fonts in **Format/Preset** fields to open the “Export Settings” window.

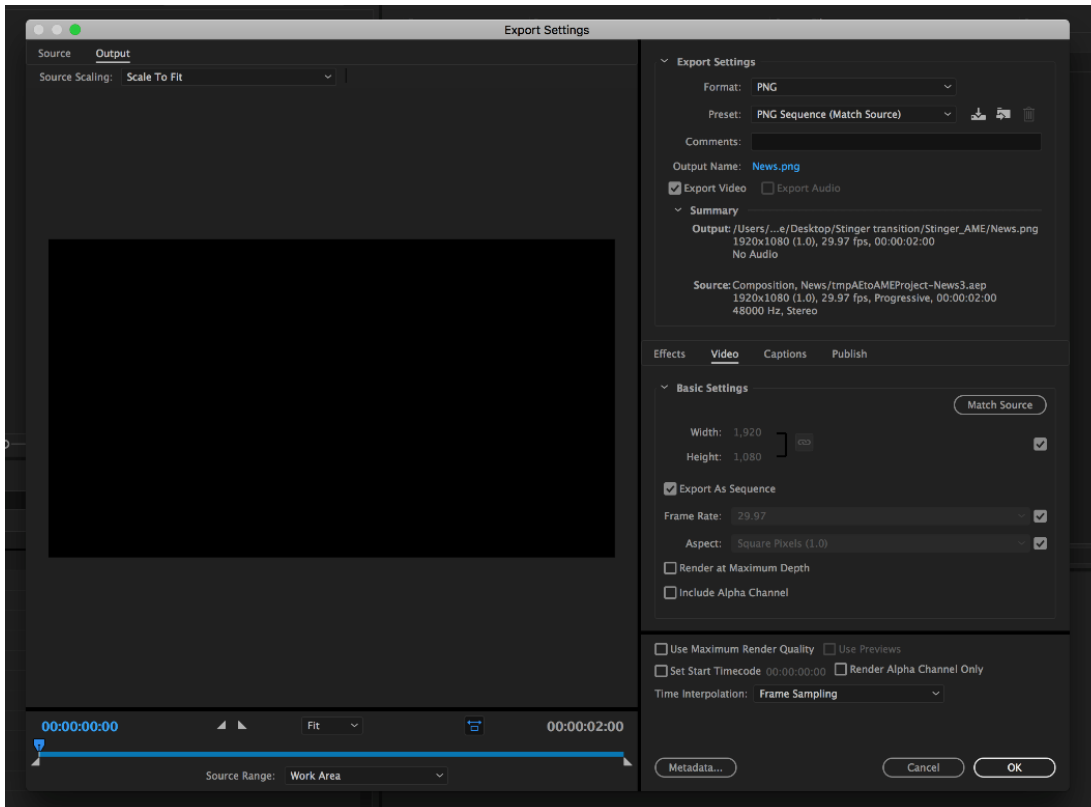
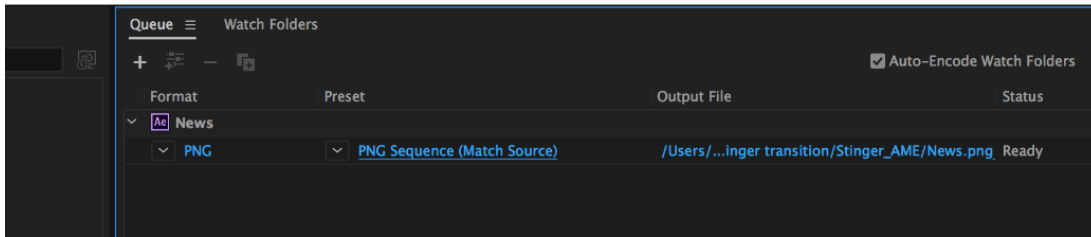

3. Click the **Format** dropdown list and then select **PNG**.

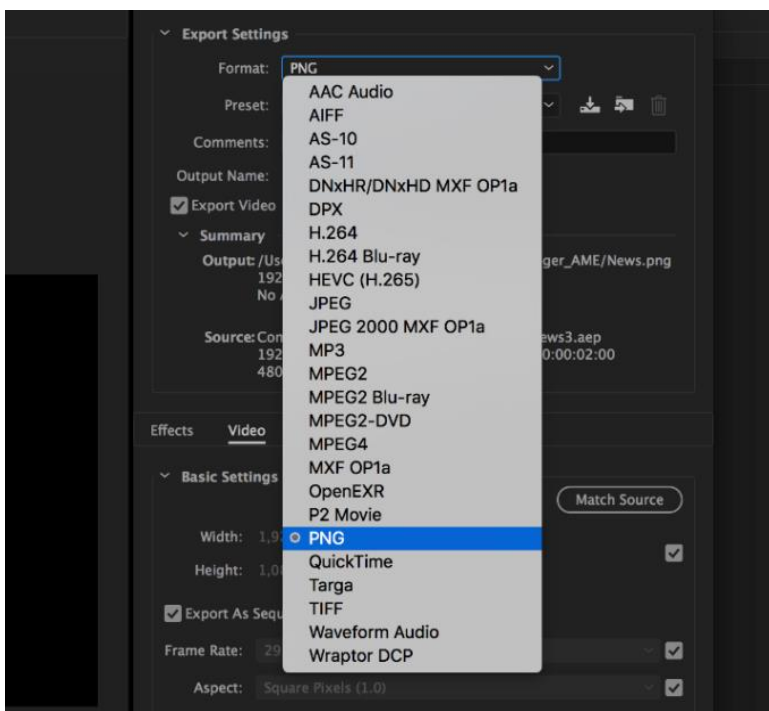

4. Click the **Preset** dropdown list and select **“PNG Sequence with Alpha.”**

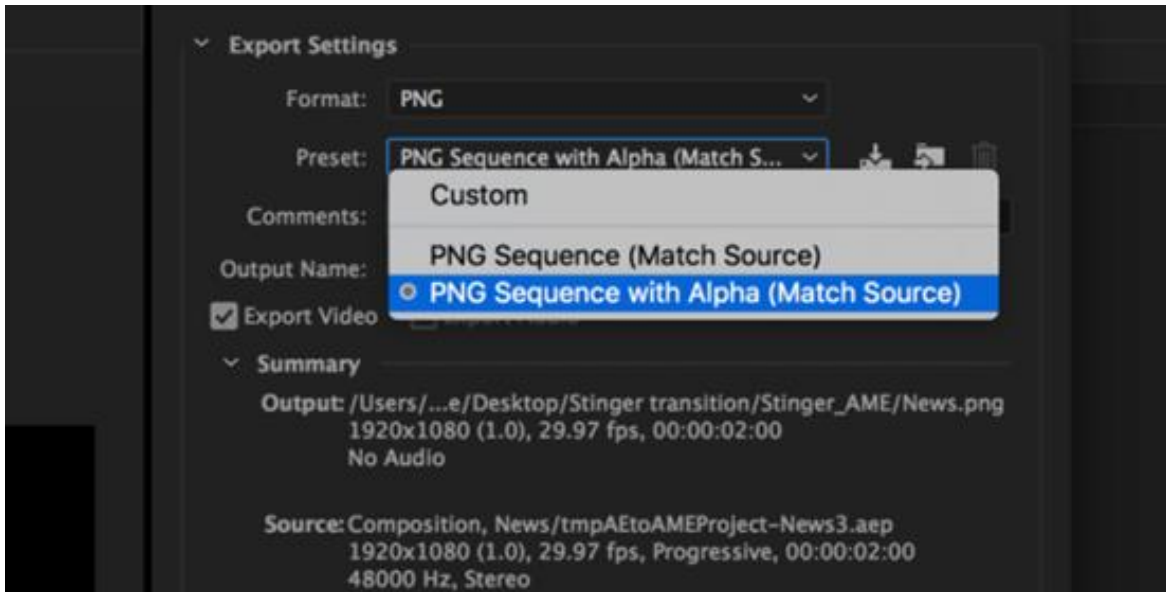

5. Make sure **“Export As Sequence”** and **“Include Alpha Channel”** are checked and then click **OK**.

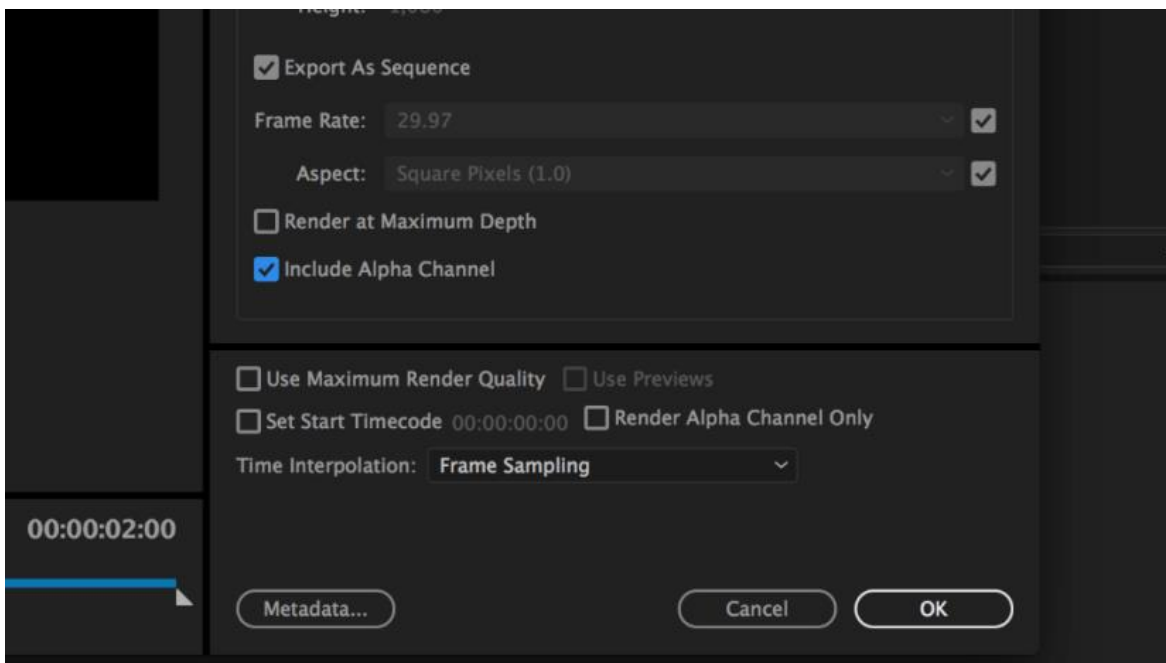

6. Select **“Output File”** to choose the render files destination. Click the green button to render.

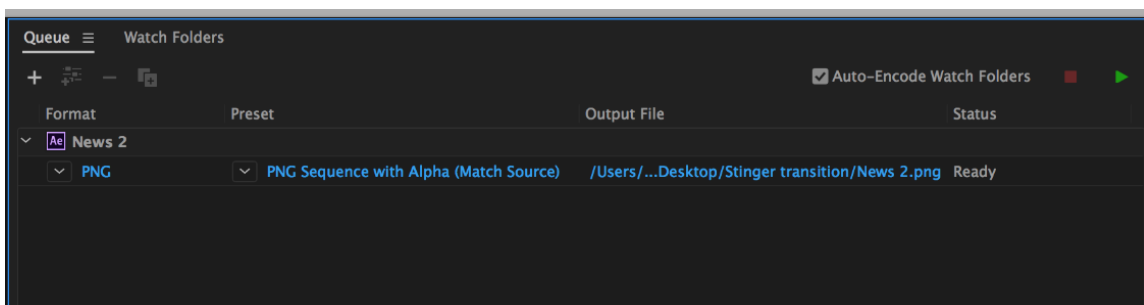

7. Once completed, the status will display “Done.”

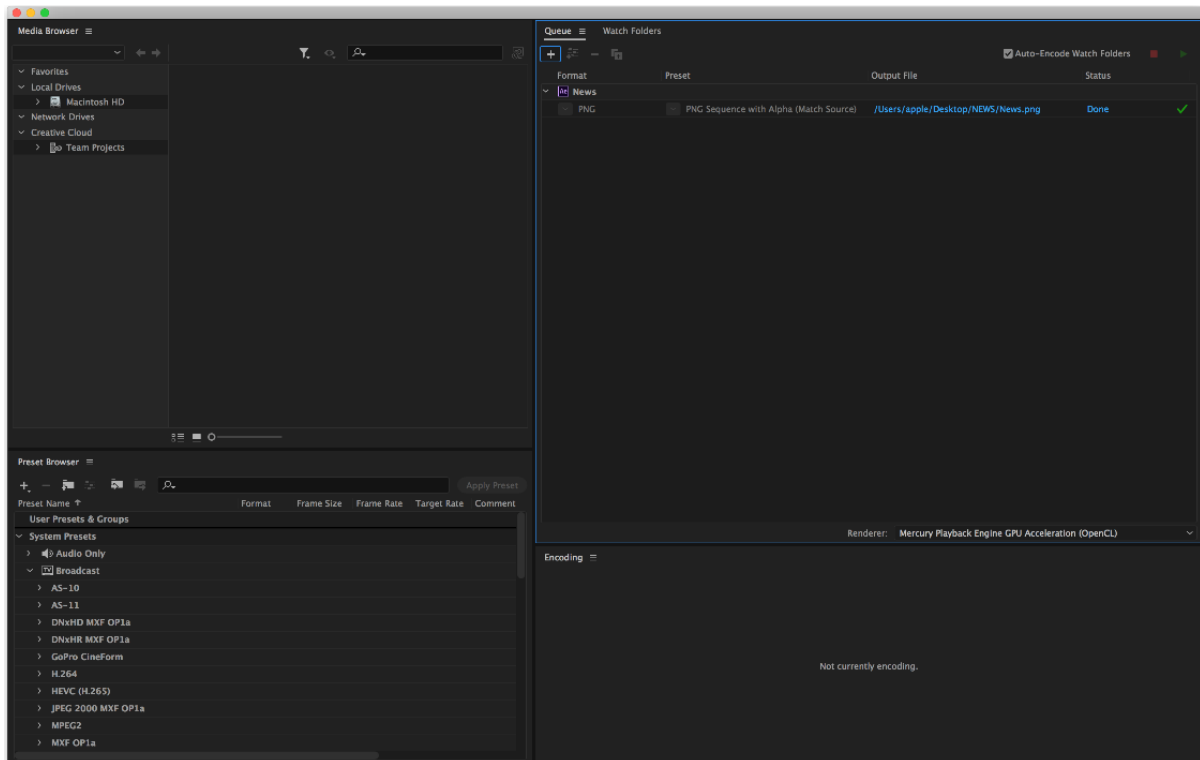

After the sequential files are created and ready, see the following sub-sections on how you can import the Clip file to the switcher.

Important things to note while creating Stinger Transition Effects

When using Datavideo’s HS-2600 Multi-Channel Switcher to design and create the Stinger Transition Effects, in addition to being creative, there are a few things that you need to take into account of.

1. Length limit of the stinger transition animation

The length of a good stinger transition animation should be approximately 0.5 to 2 seconds.

2. The HS-2600 allows a maximum of 120 image files in an animation sequence

The number of image files will determine the length of stinger transition time.

3. While designing the animation, it is best to have an image that fills up the entire frame to create a satisfactory visual effect (please see the images below).





5.5 Enabling Still Logo

The HS-2600's logo function places a logo layer on your video. In this section, we will show you how to import still logo image to the switcher, load still logo image on the switcher as well as enabling the loaded still logo on Preview and Program Out.

The HS-2600 has enough storage space for up to 1000 uncompressed still logo pictures.

Loading an existing Logo from Memory

The HS-2600 allows the user to load still logo from the machine's memory to the logo buffer (Logo 1 or 2), then press either Logo 1 or Logo 2 button to enable the loaded logo on both the Preview and Program Out. Follow the steps outlined below to load the desired still logo from memory.

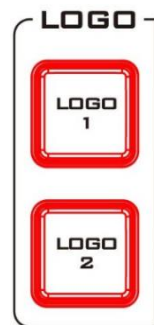

Files	File Type	Logo		
	Load Logo	Load	Logo 13	Logo 1
		Thumbnail Picture – 1	Thumbnail Picture	Thumbnail Picture + 1
		Clear Logo		Delete Logo

	Logo 1	X	-37%	X	24%	
	Logo 2	Y	0%	Y	0%	

On the still logo menu, you should find a thumbnail view of three logos. Use the up/down arrow buttons to browse all other logos which are shown in numerical order. Black thumbnails are unused memory slots.

To load a still logo, simply browse to a still logo number and select a logo buffer then select 'Load'. The selected still logo will be loaded into the selected buffer. In the above example, logo 1 will be loaded with the logo saved in memory slot 13.

To adjust the logo position, simply change the **X** and **Y** values of the respective logo buffer which can be found at the bottom of the **Logo** menu.

Selecting “**Clear Logo**” clears the logo buffer. Selection of “**Delete Logo**” removes the logo from the selected memory slot.

Importing Still Logo from PC

The Switcher Image Import/Export software (**SwitcherImagelmEx_vx.x.x.msi**) allows the user to import still logos from the PC to a designated memory slot of the switcher. **The software installation package can be downloaded from the product page.**

Note: A standard still logo is basically a still picture with an aspect ratio limited to 480x1080.

See [Chapter 3](#) for software installation and [Section 2.2](#) for network configuration.

How to use

1. Open the Switcher Image Import/Export Program and make sure the **Connect Status** shows “**Connected**” (shows **Not Connected** if disconnected).

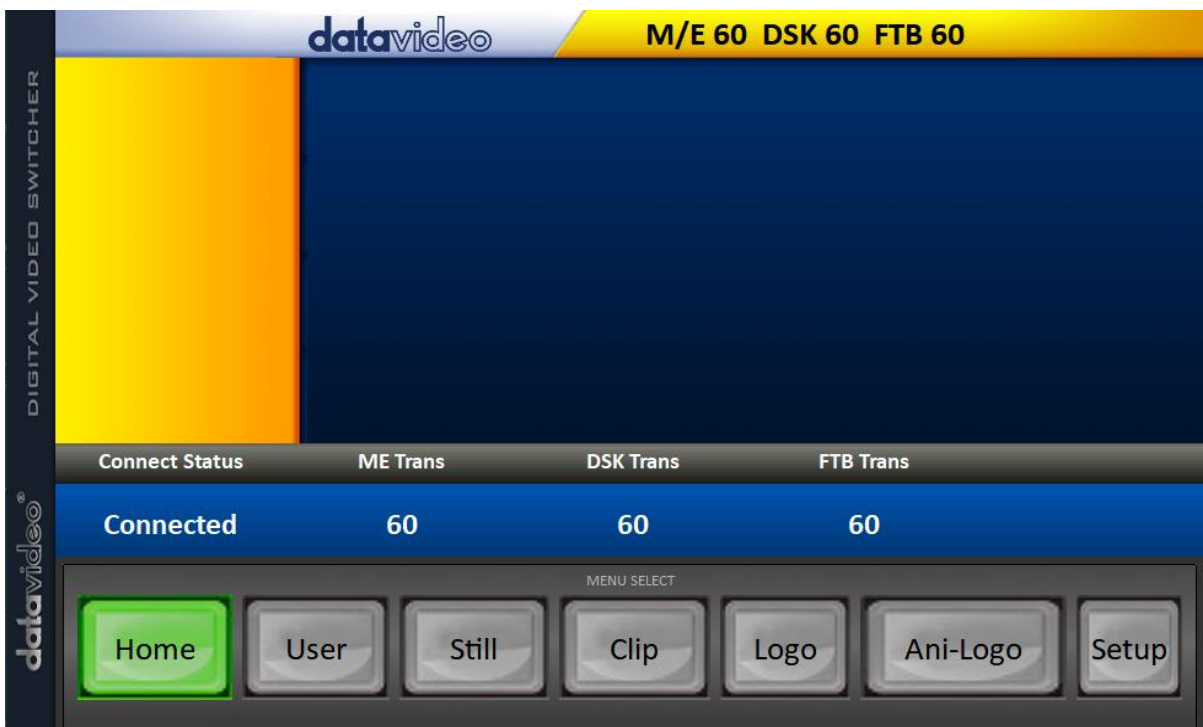

2. Clicking the **Logo** button to view logo thumbnails and import logos from your PC to the switcher.

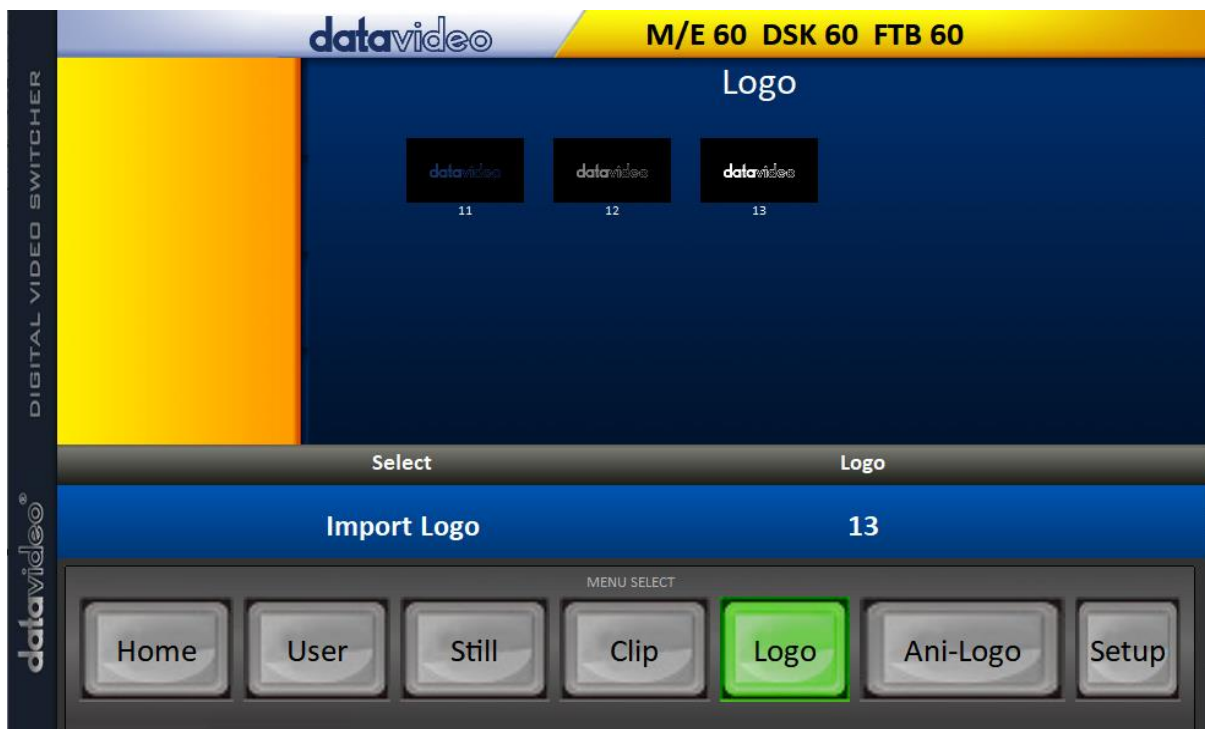

3. Click “**Logo**” number then enter a memory slot number. Click “**Import Logo**” to open the file browser window and browse to the file that you would like to import.

4. Select the logo file that you would like to import. **Note that the aspect ratio is limited to 480x1080.**

5. Check on the program’s Logo page to make sure that the logo has been imported successfully.

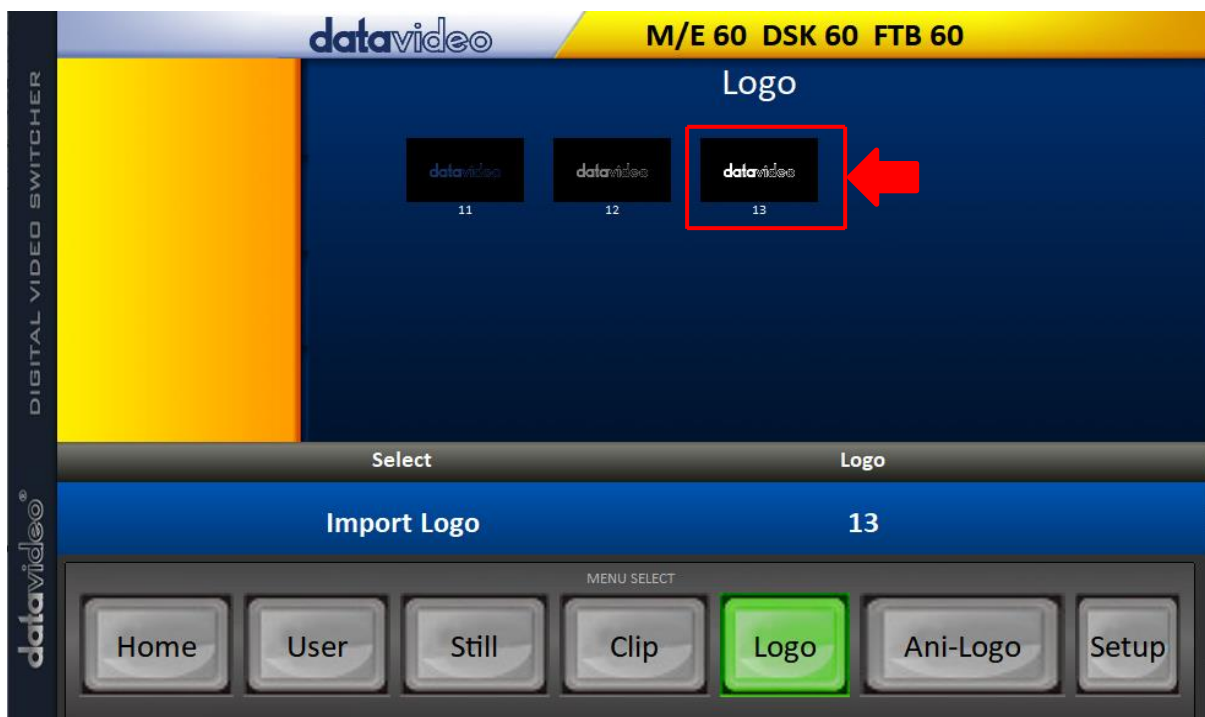

6. After successfully importing the logo into the switcher, you will then be able to start loading the new logo to the buffer. To enable the logo on Preview and Program Out, press the Logo button.

5.6 Enabling Logo Animation

The HS-2600's logo animation function places an animated logo layer on your video. Each animated logo consists of a series of 120 sequential files in bmp, jpg, png or pic format. Every image file is limited to an aspect ratio of 480x270.

In this section, we will show you how to import animated logo to the switcher, load animated logo on the switcher as well as enabling the loaded animated logo on Preview and Program Out.

Note: The HS-2600 has enough storage space for up to 1000 uncompressed animated logo.

Loading an existing Ani-Logo from Memory

The HS-2600 allows the user to load ani logo from the machine's memory to the logo buffer (Logo 1 or 2), then press either Logo 1 or Logo 2 button to enable the loaded ani logo on both the Preview and Program Out. Follow the steps outlined below to load the desired ani logo from memory.

Files	File Type	Ani Logo		
	Load Ani Logo	Load	Ani Logo 13	Logo 1
		Thumbnail Picture - 1	Thumbnail Picture	Thumbnail Picture + 1
		Clear Ani Logo		Delete Ani Logo
	Logo 1	X -37%	X 24%	
	Logo 2	Y 0%	Y 0%	

On the ani logo menu, you should find a thumbnail view of three animated logos. Use the up/down arrow buttons to browse all other animated logos which are shown in numerical order. Black thumbnails are unused memory slots.

To load an animated logo, simply browse to an ani logo number and select a logo buffer then select '**Load**'. The selected animated logo will be loaded into the selected buffer. In the above example, logo 1 will be loaded with the animated logo saved in memory slot 13.

To adjust the animated logo position, simply change the **X** and **Y** values of the respective logo buffer which can be found at the bottom of the **Ani Logo** menu.

Selecting "**Clear Logo**" clears the logo buffer. Selection of "**Delete Logo**" removes the animated logo from the selected memory slot.

Importing Animated Logo from PC

The Switcher Image Import/Export software (**SwitcherImageImEx_vx.x.x.msi**) allows the user to import animated logos from the PC to a designated memory slot of the switcher. **The software installation package can be downloaded from the product page.**

Note: Each animated logo consists of a series of 120 sequential files in bmp, jpg, png or pic format. Every image file is limited to an aspect ratio of 480x270.

See [Chapter 3](#) for software installation and [Section 2.2](#) for network configuration.

How to use

1. Open the Switcher Image Import/Export Program and make sure the **Connect Status** shows **“Connected”** (shows **Not Connected** if disconnected).

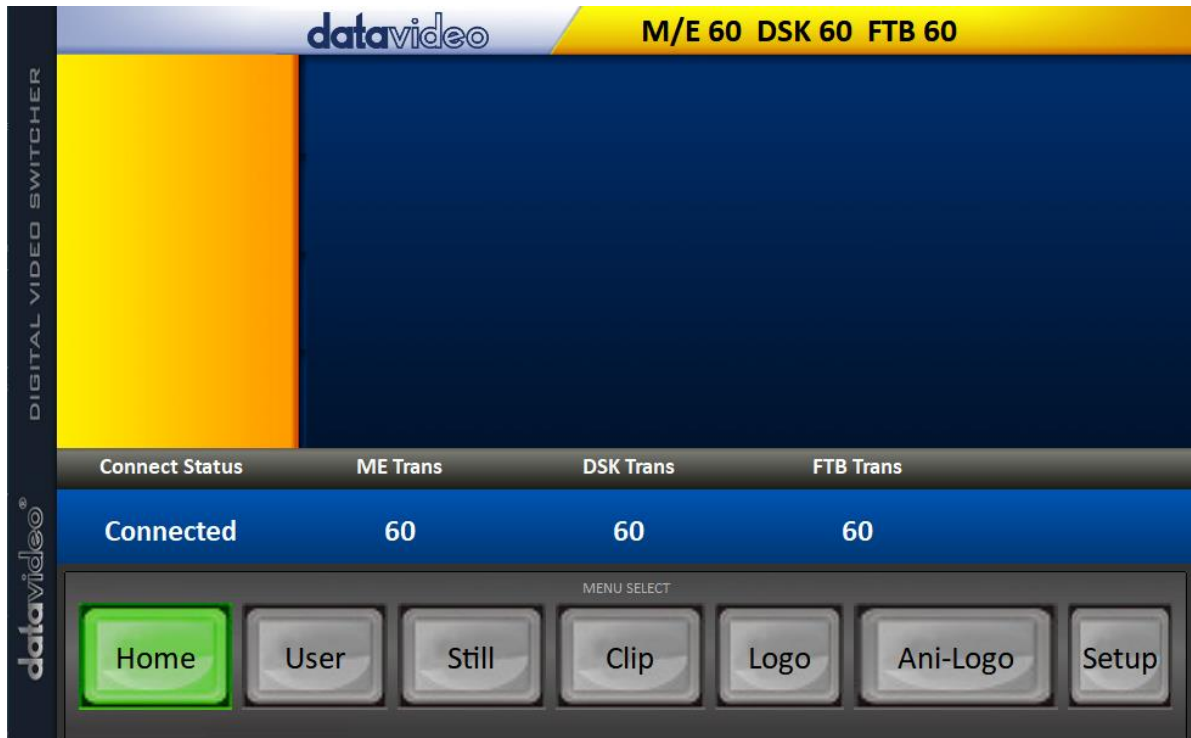

2. Clicking the **Ani-Logo** button to view animated logo thumbnails and import animated logos from your PC to the switcher.

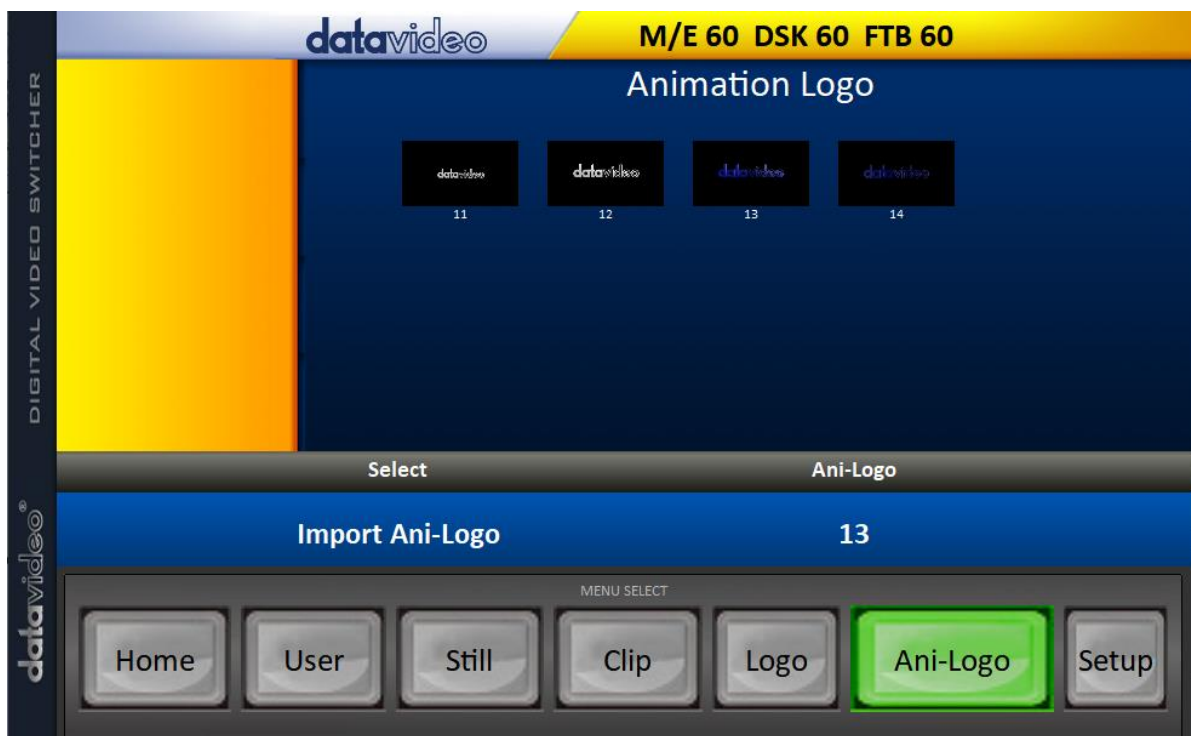

3. Click **“Ani Logo”** number then enter a memory slot number. Click **“Import Ani-Logo”** to open the file browser window and browse to the file that you would like to import.
4. Select the animated logo file at the zeroth location so upon file import, the program will then link all images up into a sequential animation file. If your files are not the .pic format, they will be automatically converted to .pic format by the program first.
5. Check on the program’s Ani Logo page to make sure that the animated logo has been imported successfully.

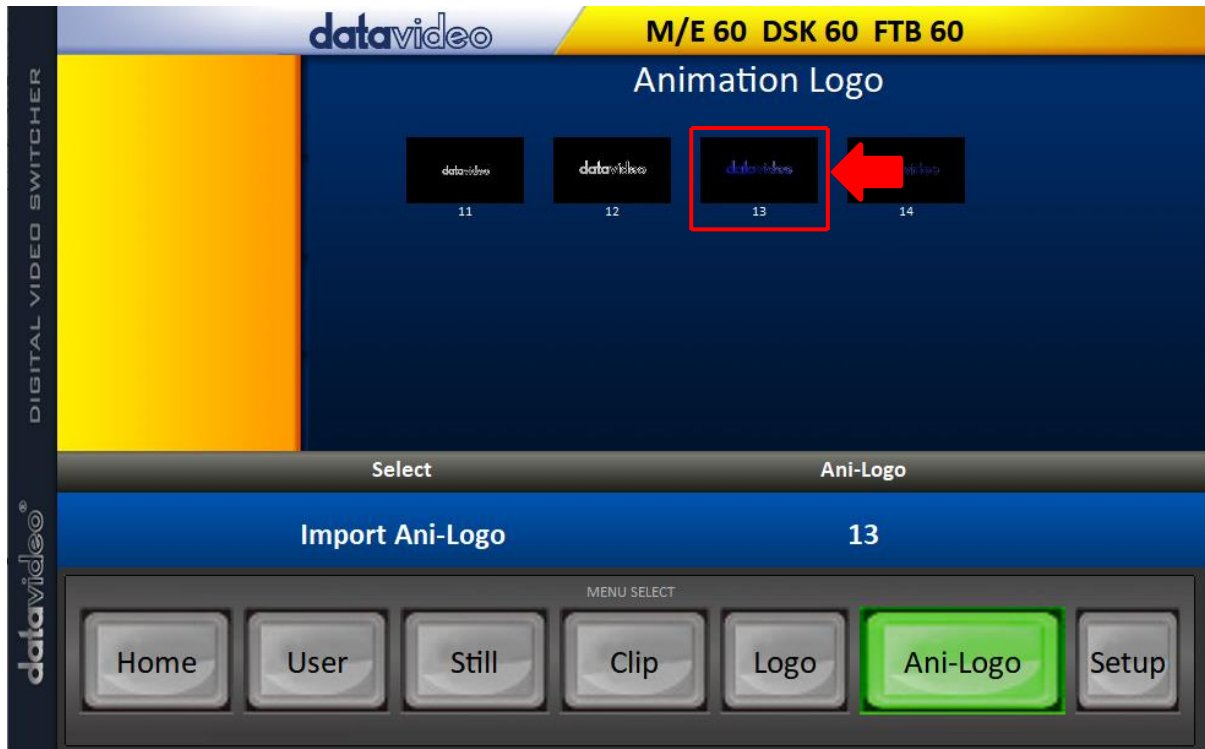

6. After successfully importing the animated logo into the switcher, you will then be able to start loading the new animated logo to the buffer. To enable the animated logo on Preview and Program Out, press the Logo button.

Chapter 6. Advanced Operation

The HS-2600 is a High Definition Digital Video Switcher. As well as mixing video and audio sources, it has additional functions such as Picture In Picture (PIP), DSK, LUMA KEY, Chroma Key and Logos.

Before attempting to use the HS-2600's PIP, DSK LUMA KEY and LOGO functions it may help to first understand the order of the video layers at the HS-2600 Program (PGM) outputs.

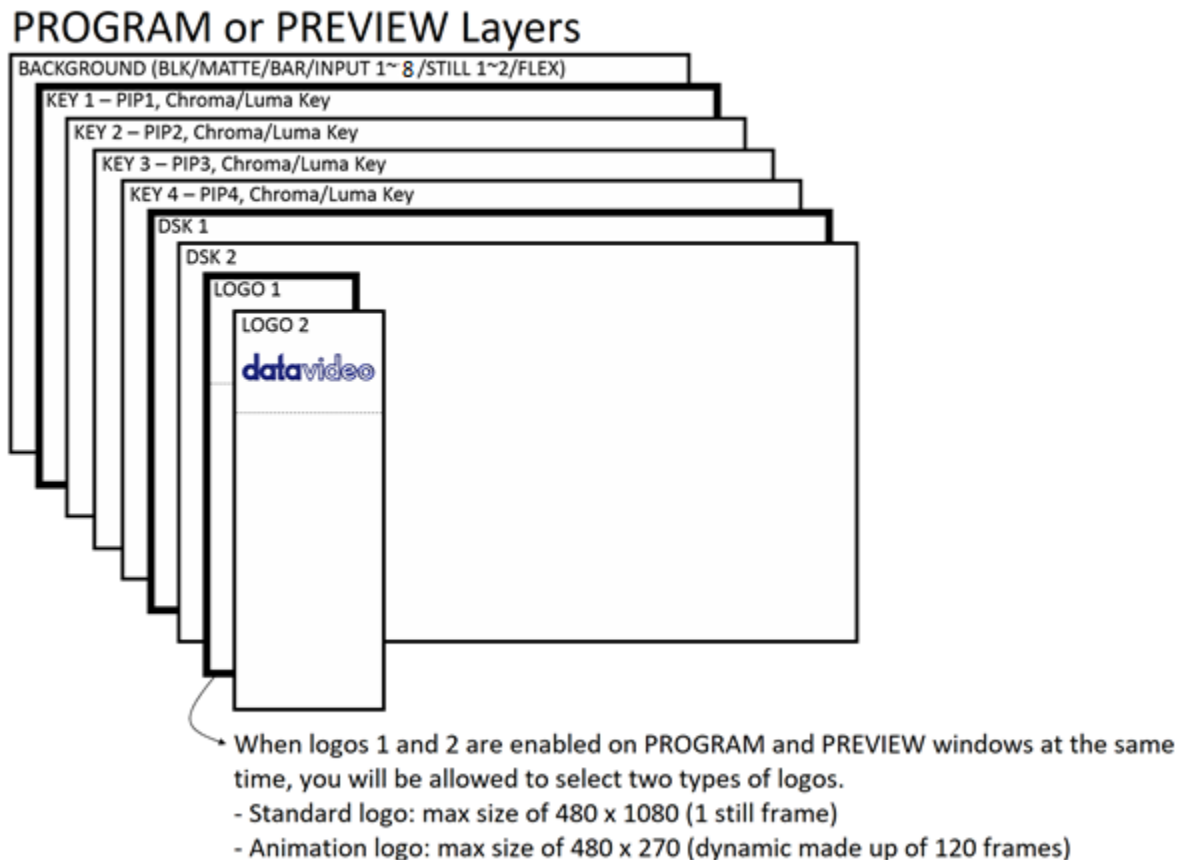

The **Background video layer** is the normal video layer (**black screen, color matte, color bars, inputs 1-8, still pictures 1 and 2 or Flex™ sources**) when mixing and switching with the HS-2600. It occupies the whole screen area of the Program output. This layer can be hidden or partly hidden by the PIP, DSK and LOGO layers in front of it.

The **Key 1 layer (PIP1, chroma key or luma key)** does not occupy the whole screen and is shown in front of the Background video layer when enabled.

The **Key 2 layer (PIP2, chroma key or luma key)** does not occupy the whole screen and is shown in front of the Background video and Key 1 layers when enabled.

The **Key 3 layer (PIP3, chroma key or luma key)** does not occupy the whole screen and is shown in front of the Background video, Key 1 and Key 2 layers when enabled.

The **Key 4 layer (PIP4, chroma key or luma key)** does not occupy the whole screen and is shown in front of the Background video, Key 1, Key 2 and Key 3 layers when enabled.

In some setups the Key image can be hidden behind other key images. This is not a fault. Change the position or size of the Key image if required.

The **DSK 1 layer** can occupy the whole screen. If set up incorrectly this layer can stop the video layers behind it from being seen properly. Re-adjust your DSK 1 settings or switch off the DSK1 function on the HS-2600 to restore the video behind it.

The **DSK 2 layer** can occupy the whole screen. If set up incorrectly this layer can stop the video layers behind it from being seen properly. Re-adjust your DSK 2 settings or switch off the DSK2 function on the HS-2600 to restore the video behind it.

The logo layer is the uppermost layer. If standard logo (still) is chosen, the maximum logo size will be restricted to 480x1080. If animation logo (dynamic) is chosen, the logo will be confined within 480x270.

Note: Where possible prepare and position the upper video layer elements in advance of the live production starting to avoid them appearing on the program output incorrectly.

Most broadcast networks have guidelines and advice on the use of video, images, music, logos and on screen text so it is best to check beforehand when planning a production. Do not use copyright protected content until you have the relevant permissions. Information on royalty free video, images and music is widely available, speak to your local dealer or search for advice on the internet.

6.1 Picture-in-Picture and Downstream Key

The **Picture in Picture (PIP)** feature of the **Key 1, Key 2, Key 3 and Key 4** layers can be used for displaying a smaller secondary image in front of the background video layer. This smaller PIP image can be resized, cropped, repositioned and even keyed by the user to avoid an important part of the background video layer being covered by it.

The **Down Stream Key layers (DSK 1 & DSK 2)** are placed on top of all the previous layers. These layers are typically used with Character Generator inputs for displaying titles, graphics, lower thirds, clocks and logos. Datavideo offer several Character Generator products (additional purchase) such as TC-200, CG-250, CG-10 and CG-500. If set up incorrectly these DSK layers can also stop the video layers behind them from being displayed properly.

The HS-2600 has six dedicated keyers, **Key1, Key2, Key3, Key4, DSK 1 and DSK 2**. All six keyers can be active simultaneously.

Picture-In-Picture

In this example, we are supplying the HS-2600 with an HD-SDI live video signal to input 2; this is selected on the Program row. We have also assigned a STILL image to input 6. This still image, selected on the [Keyer](#) sub menu, will be displayed in the PIP window.

Note: See [Section 5.3](#) for assigning a STILL image to input 6.

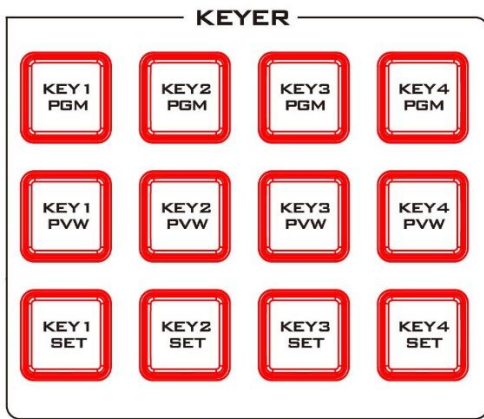

On the HS-2600 Control Panel / Keyboard there are eight **KEYER** keys. These are labelled Program and Preview. The upper **KEYER** keys relate to activating Picture-In-Picture images on the Program outputs. The lower **KEYER** keys relate to activating Picture-In-Picture images on the Multi-view or Preview outputs. Before activating Picture-In-Picture images on the output image, you should first set these **KEYER** keys to PIP mode.

Assigning a video source to a PIP window

On the **Keyer** sub menu you can assign a selected input to the chosen PIP video layer.

1. Open the **Keyer** sub menu and in the **Keyer Ctrl** option, set **Key 1** to the desired Key (**Luma**, **Chroma** and **Linear**) and PIP mode as shown below.

Keyer	Keyer	Key 1	Normal		
	Keyer Ctrl	Luma	PIP	Opac	100%
		Lift 0%	Gain 1.0	Invert	Off
	Key Source	Input 1	Fill Black		
	Mask	Left 0%	Right 0%		
		Top 0%	Bot 0%		

2. In the **Key Source** option, assign an input source.
3. Activate PIP window on the Preview or Program output by pressing **Key 1 PVW** or **Key 1 PGM** button so that you can adjust the PIP window while viewing the changes made.
4. Open the **P-in-P** sub menu and adjust the PIP window settings (**positions**, **border**, **shade matte** and **crop**). For descriptions of the parameters, refer to the section on [P-In-P](#) for more details.

P-in-P	Keyer	Key 1		Fine	Normal
	Position	X 20%	Y 10%	Size	40%
	Border	Normal			
		Luma 100%	Sat 80%	Hue	0
		Width 2%	Soft 0%	Opac	100%
	Shade Matte	Luma 100%	Sat 80%	Hue	60
		Shade Soft 2%	Shade Pos 50	Direction	35
	Crop	Left 0%	Right 0%	Size	0%
		Top 0%	Bot 0%	Soft	0%

Assigning a video source to a PIP window using shortcut keys

In addition to assigning a video source to a PIP window on the **OSD MENU**, the user can also use shortcut keys to easily switch between different PIP image sources. Press and hold **KEY 1-4 PGM** buttons, and the program and preview rows will start flashing. Press the program row buttons to switch the PIP image source.

Character Generator

CG mode allows you to linear key the CG text or graphics over the live video. Simply connect the laptop, with CG software installed, to one of the HDMI inputs (inputs 5 to 8) of the switcher. Ensure that your input image or video resolution matches the switcher’s resolution set in [OSD menu](#) → [Setup](#) → [Standard](#).

Then follow the steps below to set up the CG text or graphics:

1. Connect the laptop to one of the HDMI ports of the HS-2600 switcher using an HDMI cable. In this example, we will be using HDMI port 5 for illustration purpose.
2. Open CG-500 on the laptop and create a CG image.
3. Switch ON the HS-2600’s power button and after the boot up is complete, the Multiview should be displayed on the connected monitor.
4. On the Multiview, Input 5 window should display the CG image.
5. Press the “**MENU**” button on the HS-2600’s control panel to open the OSD menu on the Multiview display and then select the “**Inputs**” sub menu.
6. Select “**Input 5**” in the **Input** option and in the second mode option, enable CG mode.

Inputs	Input	Input 5	Mode	Live	Mode	CG Md
	Proc Amp	Black 0%	White 100%		Chrom	1.0
	Audio	Gain 0 dB	Delay 0 ms			
	Crosspoint	Input 9				
	Audio XPT	Off				

7. Open the “**Keyer**” sub menu.
8. Select “**DSK 1 or 2**” in the **Keyer** option and set both Key and Fill Sources to Input 5.

Keyer	Keyer	DSK1	Normal		
	Keyer Ctrl	Linear	Split	Opac	100%
		Lift 0%	Gain 1.0	Invert	Off
	Key Source	Input 5	Fill Input 9		
	Mask	Left 0%	Right 0%		
		Top 0%	Bot 0%		

9. Locate DSK buttons on the switcher’s control panel then depending on the settings selected at Step 8, press DSK 1 or 2 button to open your CG graphics on either of the preview and program windows or both.

DSK Preview and DSK Program

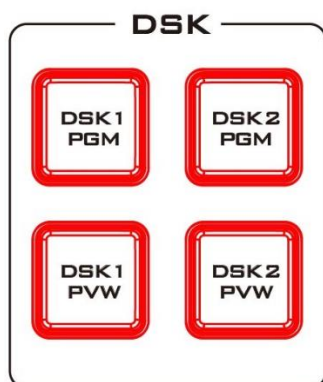

On the HS-2600 Control Panel / Keyboard there are four DSK keys. These are labelled Program and Preview. The upper DSK1 and DSK2 keys relate to activating Down Stream Keying on the Program outputs. The lower DSK1 and DSK2 keys relate to activating Down Stream Keying on the Multi-view or Preview outputs.

To display the CG subtitle configured previously, simply press the DSK 1 PGM or DSK 1 PVW button to enable the downstream key on the PGM or PVW screen.

6.2 Placing text on the video using luma key



The HS-2600 allows the user to place a logo or text image (ideally black and white) on the video using the luma key function. First of all, create a 1920x1080 (16:9) text image against a black or white background on a laptop. Once the text image is created, please follow the steps outlined as follows to insert the text image.

Note: If the text image is dark, choose a white background; if the text image consists primarily of bright colors, choose a black background.

1. Connect the laptop to the switcher's **HDMI Input Port 5**.
2. Press the **MENU** button to open the OSD Menu on the Multiview display.
3. Select **Keyer** to open the **Keyer** sub menu.

Keyer	Keyer	Key 1	Normal	
	Keyer Ctrl	Luma	Self	Opac 100%
		Lift 0%	Gain 1.0	Invert Off
	Key Source	Input 5	Fill Black	
	Mask	Left 0%	Right 0%	
		Top 0%	Bot 0%	

4. Select Key 1.
5. In the **Keyer Ctrl** option, select "**Luma**" and "**Self**" to apply luma keying effect to the connected input. The luma key removes the background, in this case, the black component of the image.

6. In this example, the text image is against a black background so **reduce the Lift value to remove the black background**. Descriptions of the corresponding parameters are described below:
 - **Lift** (0 – 100%) adjusts the dark/black areas of the key image. **Reducing the value of Lift** will make dark areas of the key image more transparent. The background image will be showing only through the transparent areas.
 - **Gain** (0.0 – 16.0) adjusts the light/white areas of the key image. **Increasing the value of Gain** will make light areas of the key image more solid. The background image will be showing only through the transparent areas.
 - **Opac** (0 – 100%) adjusts the transparency of the overall foreground image, which is the text in this example. **Increasing the value of Opacity** will make the overall key image less transparent.
 - **Invert** (On/Off) sets the luma key color; luma key color is **white** if turned ON and **black** if turned OFF.
 7. Set the “**Lift**” to 100% if the background is in total black.
 8. **Opaque** logo can be created by setting the “**Opac**” parameter to 100%. Set “**Opac**” to 100% if an opaque logo is desired. **Semi-transparency** effect can be generated by setting the “**Opac**” parameter to a value between 0 and 100%.
 9. Under the **Source** option, select an input source to which the luma key settings will be applied. In this example, select “**Input 5**” since this is the port to which the laptop is connected.
- Note: Since “Self” is chosen, Fill input will be ignored.**
10. Exit the menu after the luma key settings are properly configured.
 11. Press the **Key 1 PGM** or **Key 1 PVW** button to place the text image on the Program screen or the Preview screen respectively.

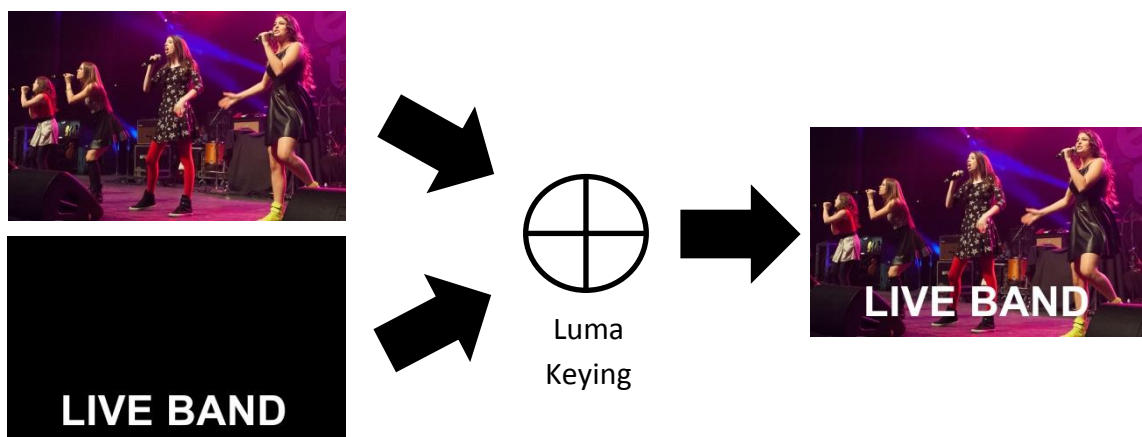

6.3 Insertion of People onto Backgrounds (Chroma Key)

The Chroma Key feature of the HS-2600 is easy to use. Typical Blue and Green screen studios can be quickly incorporated into an HS-2600 production.

The following is a quick overview of Chroma Key basics.

The **camera**, **backdrop** and **lighting** all play an important role in producing the optimal

Chroma Key result. Although the HS-2600 is equipped with excellent keying controls, it is best to start with a good keyable image.



A good foreground image helps produce a good key

Three chip/Three sensor camera

We strongly recommend the use of a three chip or three sensor camera for Chroma Key shooting. If the camera has three chips or sensors then this usually means good colour separation within the camera. The optics on these cameras are usually better too. The extra image clarity and the good colour separation help improve the quality of the subsequent keying with the camera's output.

White Balance the Camera

White Balance is extremely important after setting up a chroma key studio. The camera must be correctly white balanced to minimize the subject picking up any colour cast (green or blue) from the background. Of course the white balance settings will vary according to the type of lighting you are using, but neutral whites and good skin tone colour are the all-important targets.

To set the white balance you will need a white reference card (or a sheet of white paper). Focus the camera on the reference card and light it evenly using the main light. Set the camera's iris / aperture so that the card is correctly exposed. Use the Auto White Balance (AWB) function, or set the white balance manually so that the card appears white. If you are in any doubt about how to white balance your camera, **please refer to your Camera's instruction manual for more details.**

Lighting

Lighting of your chosen green or blue backdrop is extremely important; the more even the lighting on the backdrop the better the finished result. Lighting setups for the foreground subject will vary according to the effect that you want. For chroma keying backdrops, balanced even lighting with no hotspots or shadow areas is the aim. The easiest way to achieve balanced Chroma key lighting is with a lighting setup that looks similar to this:

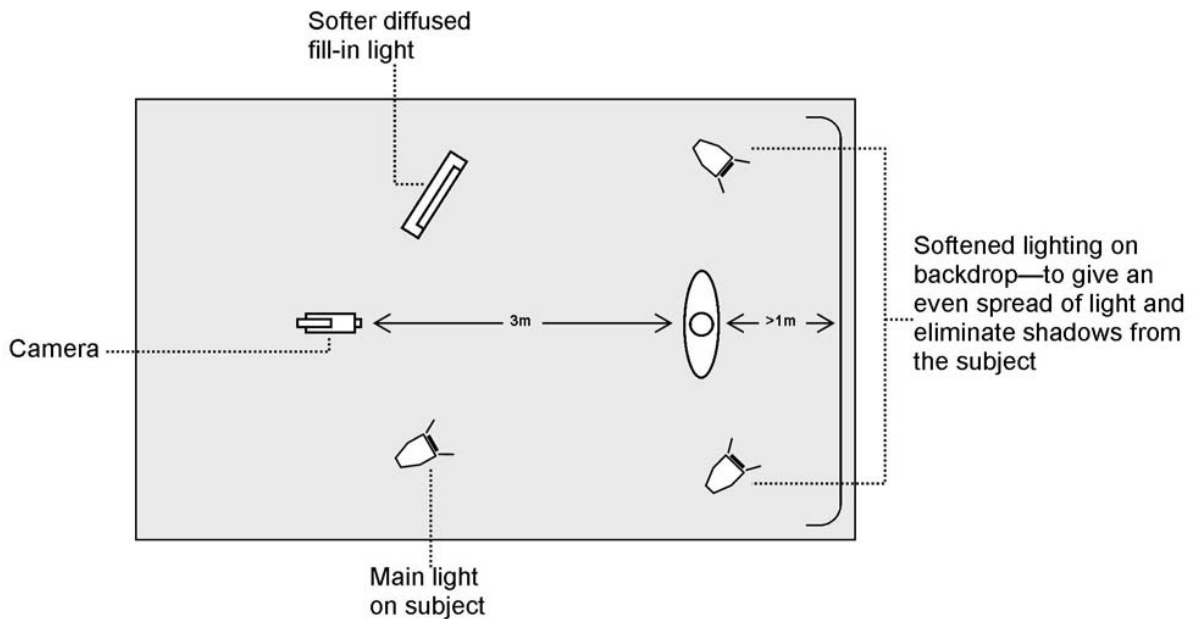

In the diagram, you will see that we recommend a **minimum** of four lights and we keep the subject **more than** 1m away from the backdrop. It is always easier to get more even lighting if the subject is farther away from the backdrop (no shadows). The foreground lighting on the subject will also vary according to the effect that you are looking for.

After the studio set up is complete, connect the camera shooting the speaker on a green backdrop to the SDI Input 1 at the rear of the switcher. To configure the settings that will be used for chroma keying, press the **MENU** button on your HS-2600 control panel to open the OSD menu on the monitor. Follow the steps below to configure the chroma key settings.

1. Open the Keyer sub menu and select Key 1.

Keyer	Keyer	Key 1	Normal	
	Keyer Ctrl	Chroma	Self	Opac 100%
		Lift 0%	Gain 1.0	Invert Off
	Key Source	Input 1	Fill Black	
	Mask	Left 0%	Right 0%	
		Top 0%	Bot 0%	

2. Select “**Chroma**” and “**Self**” under “**Keyer Ctrl**” and then select the camera source under “**Key Source**.” In this example, we have selected Input 1, which corresponds to the SDI Input 1 at the rear of the switcher and therefore the port to which the camera is connected.

3. Adjust the left, right, top and bottom values of “**Mask**” to set the chroma key range according to green or blue backdrop size.

4. Open Chroma Sub Menu and adjust the corresponding chroma key parameters. Again in this example, we have selected Input 1, which corresponds to the SDI Input 1 at the rear of the switcher.

Note: Selection of **CK Auto** automatically calculates the best Hue & Luma values for the current Keyer source.

Chroma	Keyer	Key 1	Normal		
	Key Source	Input 1			
	Key Tie	On	Input 6		
	CK Setup	CK Auto	Hue	110	
		K Range	160	Luma	80%
		K Fgnd	10%	K Bgnd	20%
		Hi-Light	0%	Lo-Light	0%
		Left	0%	Bg-Supp	OFF
		Right	0%	Soft	0%
	Mask	Left	0%	Right	0%
		Top	0%	Bot	0%

The chromakeying parameters are described below:

- **Hue:** This parameter adjusts the color of the chroma key. A typical green screen value will be around 120. Blue screen value will be around 240.
- **Luma:** The **Luma** value relates to how bright or dark the selected key colour or hue is.
- **K Range (Key Range):** **Key Range** sets the range of hues or colors (0 – 360 degrees) that closely match the background color to be keyed. The user can start with a value of 120 degrees and this value can be fine-tuned up or down depending on the setup of the green or blue screen studio.
- **K Fgnd (Key Foreground):** **Key Foreground** adjusts the performance of the chroma key in light or white areas. Apply more **Key Foreground** if the light areas are becoming too transparent.
- **K Bgnd (Key Background):** **Key Background** adjusts the performance of the chroma key in dark or black areas. Apply more **Key Background** if the dark areas are becoming too transparent.
- **Hi-Light:** Hi-light boosts the foreground key in high luminance area.
- **Lo-Light:** Lo-light boosts the foreground key in low luminance area.
- **Bg-Supp:** Turn ON **Background Suppress** removes the Luma (Brightness) of the background from the final image. If the Chroma Key Output is showing Light Edges, then the **Bgnd suppress** can be used to suppress any background Luma that is showing through on these edges.

5. After Chroma Key configuration is complete, close the OSD menu and simply press **KEY 1 PGM** or **KEY 1 PVW** button on the switcher’s control panel to place the speaker on **PGM** or **PVW** Screen as shown in the diagram below.

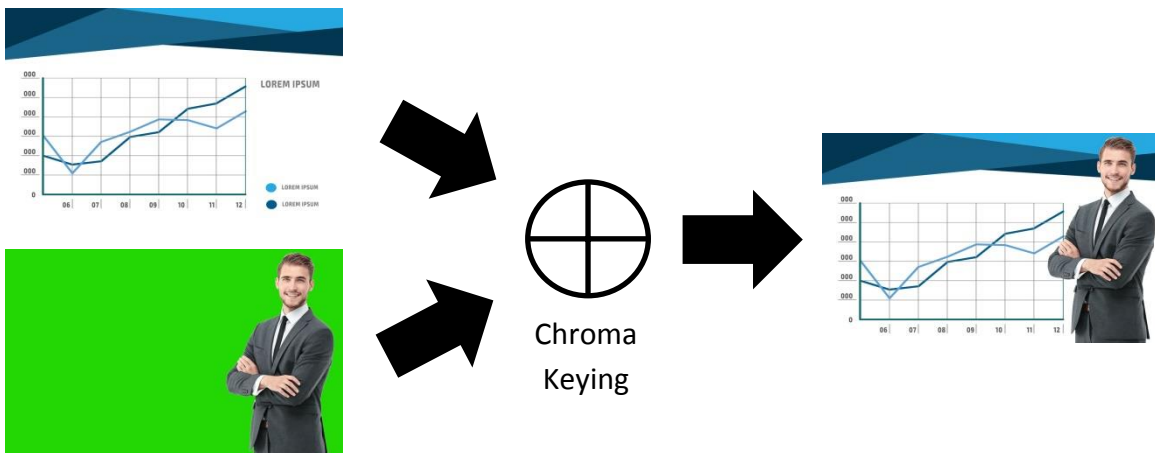

6.4 Displaying a variety of Sources at the same time

The Flex™ output allows the user to show a variety of sources at the same time and these sources can then be fed as one combined image to the HS-2600 Program or Preview outputs.

The Flex™ output could be as simple as one background image and four smaller source images to make a basic Flex™ layout.

Alternatively it could be a lot more complex with a fifth image source making a fifth PIP window. You also have the ability to place a user defined color border around all PIP windows. You can re-size, crop, rotate and position the PIP windows in almost any manner that you wish. With the HS-2600, you will be allowed to enable up to eight PIP windows on the Flex™ output.

To configure the Flex™ settings, simply follow the steps outline below.

Basic Flex™ Output (Four PIP Windows)

1. To enable **Flex™** output on PGM or PVW window, simply press and hold down the **SHIFT** button then press the **FLEX** button. This will display the **Flex™** output layout on either the PVW or PGM screen so that you will be able to configure the **Flex™** output windows while viewing the changes.

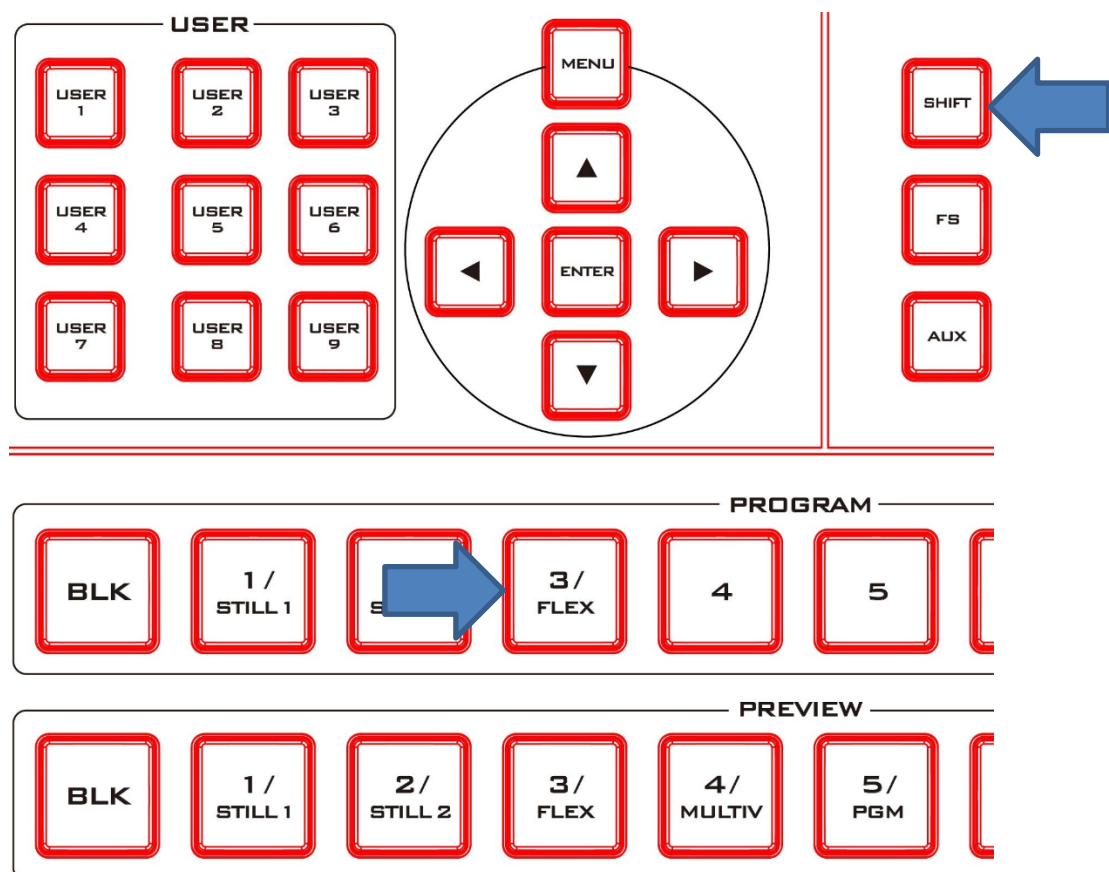

2. Press the **MENU** button on the switcher's control panel to open the OSD menu on the Multiview screen and select **Flex Src** sub menu. On the sub menu that opens, select any of the presets to enable the desired preconfigured layout on the screen.

Flex Src	Flex Src	Flex Src 1				
	Flex Src Bgnd	Black				
	P-in-P 1 Src	Black	Enable	On		
	P-in-P 2 Src	Black	Enable	On		
	P-in-P 3 Src	Black	Enable	On		
	P-in-P 4 Src	Black	Enable	On		
	Keyer 1	Input 1	Input 2		Enable	On
	Flex Preset	Preset 1	Preset 2		Preset 3	
		Preset 4	Preset 5		Preset 6	

3. The **Flex™** output consists of one background image and four smaller source images overlapped on the background image in four separate individual PIP windows. The options above the **Keyer** row allow you to select a source for the background (**FLEX Src Bgnd**) and then assign an input source to the respective **Flex™** output windows (**P-in-P 1 Src** to **P-in-P 4 Src**).

Flex Src	Flex Src	Flex Src 1				
	Flex Src Bgnd	Input 4				
	P-in-P 1 Src	Input 6	Enable	On		
	P-in-P 2 Src	Input 7	Enable	On		
	P-in-P 3 Src	Input 5	Enable	On		
	P-in-P 4 Src	Input 8	Enable	On		
	Keyer 1	Input 1	Input 2		Enable	On
	Flex Preset	Preset 1	Preset 2		Preset 3	
		Preset 4	Preset 5		Preset 6	

4. In order to configure the corresponding FLEX window's size, position, border style, border color, border width and the crop settings, open the P-in-P sub menu and in the **Keyer** option, you will be able to find options **Flex PinP 1 to 4**. Select one of them and adjust the **Flex™ P-in-P** windows accordingly.

P-in-P	Keyer	Flex PinP 1			Fine	Normal
	Position	X 20%	Y 10%	Size	40%	
	Border	Normal				
		Luma 100%	Sat 80%	Hue	0	
		Width 2%	Soft 0%	Opac	100%	
	Shade Matte	Luma 100%	Sat 80%	Hue	60	
		Shade 2%	Shade 50	Direction	35	
		Soft	Pos			
	Crop	Left 0%	Right 0%	Size	0%	
		Top 0%	Bot 0%	Soft	0%	

5. Once configured, save the **Flex™** settings in User Memories for easy access.

After the **Flex™** settings are successfully configured, as depicted in the diagram below, each FLEX window will display the respective source images. Use the **Flex™** feature in different scenarios and apply the proper keying effect accordingly.



Flex™ and Downstream Key: Talk Show and Interview TV Show



Flex™ and Chroma Key: Educational Program



Flex™, Chroma Key, Luma Key and PIP: Cultural Program or Live Sports Program



Assigning a video source to a PIP window using shortcut keys

In addition to assigning a video source to a Flex™ output window using the OSD MENU, the user can also use shortcut keys to easily change the Flex™ output window sources. Press and hold down one of KEY 1-4 PVW buttons to select a Flex™ output window, and as the program row is backlit red, press the channel buttons to change the Flex™ output window content.

Simultaneously Enabling up to Eight PIP Windows

The HS-2600 allows you to enable up to eight PIP windows at the same time. This can be achieved by enabling the Flex™ output along with the four keys built into the HS-2600.

Before using this feature, the four keyers must be set to PIP mode and the four FLEX windows must be adjusted and positioned accordingly. The steps outlined below will guide you in configuring the eight PIP windows.

1. To enable **Flex™** output on PGM or PVW window, simply press and hold down the **SHIFT** button then press the **FLEX** button. This will display the **Flex™** output layout on either the PVW or PGM screen so that you will be able to configure the **Flex™** output windows while viewing the changes.
2. Pre-configure the four **Flex™** output windows in the **P-in-P** sub menu by adjusting the size and position of the corresponding windows. Remember to modify the luma key parameters accordingly. Note that you can change the **Flex™** output window content in the **Flex Src** sub menu.

P-in-P	Keyer	Flex PinP 1			Fine	Normal
	Position	X	20%	Y	10%	Size 40%
	Border	Normal				
		Luma	100%	Sat	80%	Hue 0
		Width	2%	Soft	0%	Opac 100%
	Shade Matte	Luma	100%	Sat	80%	Hue 60
		Shade Soft	2%	Shade Pos	50	Direction 35
	Crop	Left	0%	Right	0%	Size 0%
		Top	0%	Bot	0%	Soft 0%

3. Open the **Keyer** sub menu, set Keyers 1 – 4 to **PIP** mode and enable **Luma Key**.

Keyer	Keyer	Key 1	Normal	
	Keyer Ctrl	Luma	P-in-P	Opac 100%
		Lift	0%	Gain 1.0
	Key Source	Input 1	Fill	Black
	Mask	Left	0%	Right 0%
		Top	0%	Bot 0%

4. Adjust the P-in-P windows in the P-in-P sub menu.

P-in-P	Keyer	Key 1			Fine	Normal
	Position	X	20%	Y	10%	Size 40%
	Border	Normal				
		Luma	100%	Sat	80%	Hue 0
		Width	2%	Soft	0%	Opac 100%
	Shade Matte	Luma	100%	Sat	80%	Hue 60
		Shade Soft	2%	Shade Pos	50	Direction 35
	Crop	Left	0%	Right	0%	Size 0%
		Top	0%	Bot	0%	Soft 0%

5. After the **Flex™** output and the four PIP windows are successfully configured, enable the **Flex™** output by pressing the **Flex™** button while holding down the **SHIFT** button, and then press **KEY1 PGM** to **KEY4 PGM** buttons to activate the four PIP windows on the **Program** Output. The diagrams below provide an example of an eight PIP window display.

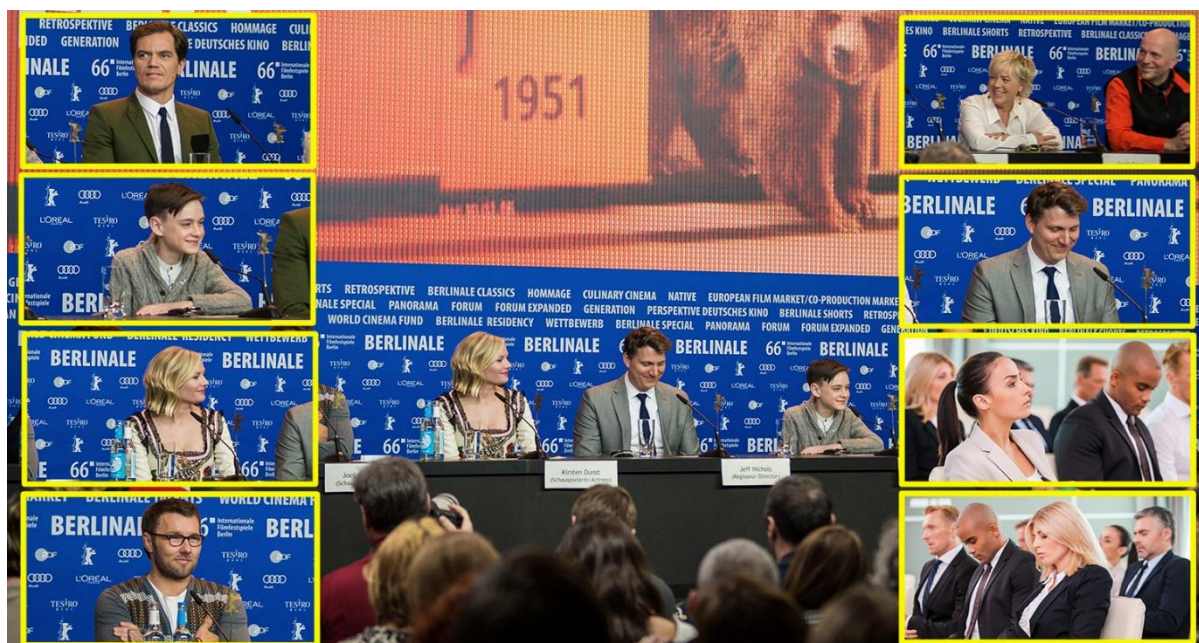

6.5 Shortcut Keys to assigning Output Sources

In general, the HS-2600 offers 4 output ports (**SDI 1 – 3 / HDMI 1**) and all ports can be configured to output one of the following:

- Flex Src 1
- Still 2
- Still 1
- Input 1 – 8
- CLN PVW (Clean PVW)
- CLN PGM (Clean PGM)
- PG + DSK
- PVW
- PGM
- MultiV (Multi view)

In addition to setting the source of these 4 output ports in **OSD menu → Outputs → Output**, you can also use the shortcut keys on the control panel to assign the output sources. The instructions are outlined as follows:

1. The diagram below depicts the corresponding buttons for selecting the respective output ports as well as the video sources. The program row on the top allows you to first select the output port, and the preview row below allows you to then assign a video source to the selected output port.

Note: Each button on the preview row is assigned to two video sources. Pressing the BLK button switches between the two video sources.

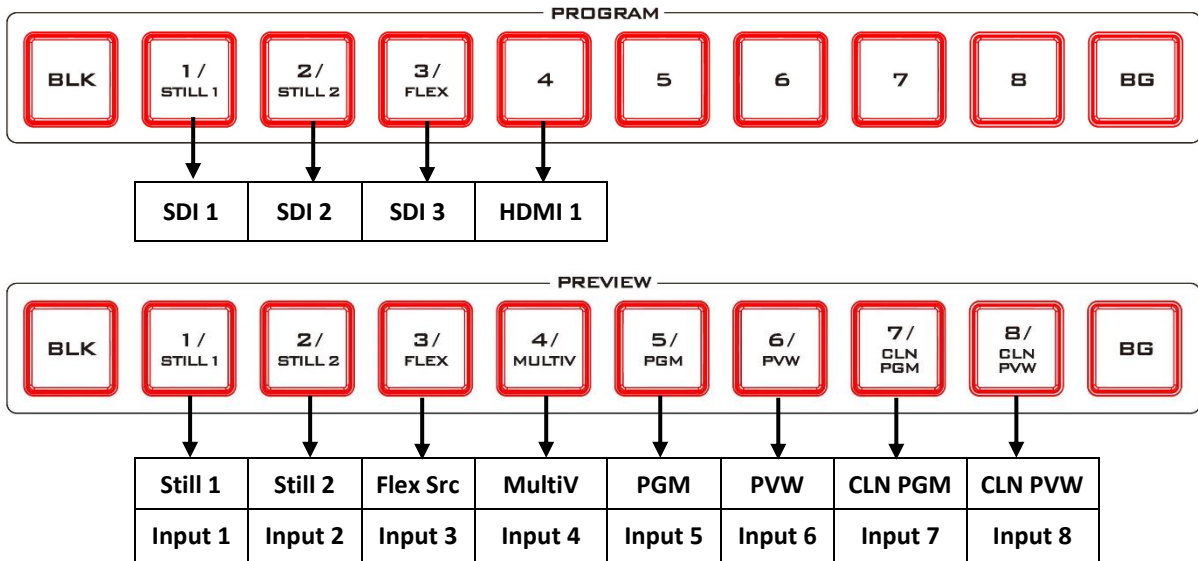

2. Upon pressing the AUX button, you will see the following button LED behavior:
 - Buttons 1 – 4 on the program row turn solid red except for Button 1 which should be flashing by default.
 - Buttons BLK – 8 on the preview row should turn solid blue except for one flashing button that is the video source assigned to the output port selected on the program row.
3. Press one of buttons 1 – 4 on the program row to select an output port. The selected button should turn flashing red.
4. Press one of buttons 1 – 8 on the preview row to select a video source; the corresponding video sources are listed as follows:
 - 1 : Still 1
 - 2 : Still 2
 - 3 : Flex Src 1
 - 4 : MultiV
 - 5 : PGM
 - 6 : PVW
 - 7 : CLN PGM
 - 8 : CLN PVW

Once selected, the button should turn flashing blue.
5. To select input 1 – 8 video sources, you will need to press the **BLK** button to switch to another group of video sources. All buttons on the preview row should turn solid green. Press the corresponding button to select the video source and the selected button should turn flashing green, indicating that the assignment is successful. Button 1 corresponds to input 1, button 2 corresponds to input 2 and etc.
6. Press the **AUX** button to deactivate the shortcut keys.

Chapter 7. Monitor



The HS-2600's built-in monitor can be configured via an on screen menu. Press the **MENU** button to display the Main Menu list on the monitor.

This chapter covers the Menu options in the order that they appear on the monitor. These settings may also appear in more detail elsewhere in this instruction manual. Options may vary depending on the firmware version in use.

Use the **Up / Down** buttons to change the value and press the **ENTER** button to confirm. Once the chosen setting has been confirmed, it is stored within the switcher's non-volatile memory.

7.1 MENU Options

Main Options	Sub Options	Values	Default	
Picture	BRIGHTNESS	0 – 100	50	
	CONTRAST	0 – 100	50	
	SATURATION	0 – 100	50	
	TINT	0 – 100	50	
	SHARPNESS	0 – 100	0	
	RGB Range	Full		Full
		Limited		
	HDMI EDID	2K		4K
		4K		
	Color Space	Native		Native
		REC709		
		DCI-P3		
	Gamma	Off		2.2
		1.8		
		2.0		
		2.2		
		2.35		
	HDR	Off		Off
		On		
	BACKLIGHT	0 – 100		100
Color Temp.	3200K		6500K	
	5500K			
	6500K			
	7500K			
	9300K			
	User	Red Gain	0 – 255	128
		Green Gain	0 – 255	
Blue Gain		0 – 255		
Red Offset		0 – 511	256	
Green Offset		0 – 511		
Blue Offset		0 – 511		

Main Options	Sub Options	Values	Default
	EXIT		
Marker	Center Marker	Off	Off
		On	
	Center Marker Size	Small	Middle
		Middle	
		Large	
	Aspect Marker	Off	Off
		16:9	
		1.85:1	
		2.35:1	
		4:3	
		3:2	
	Safety Marker	Off	Off
		95%	
		93%	
		90%	
88%			
85%			
80%			
Marker Color	Red	White	
	Green		
	Blue		
	White		
	Black		
Thickness	1 – 15	6	
Exit			
Function	Scan	Aspect	Aspect
		Pixel to Pixel	
		Zoom	
	Aspect	Full	Full
		16:9	
		1.85:1	
		2.35:1	
		4:3	
		3:2	
		2.0X	
		2.0X MAG	
	Overscan	Off	Off
		On	
	Check Field	Off	Off
		Red	
Green			
Blue			
Mono			
Zoom	10%		
	20%		

Main Options	Sub Options	Values	Default
		30%	
		40%	
	False Color	Off/On	Off
	False Color Table	Off/On	On
	Exit		
Audio	Volume	0 – 100	50
	Audio Out	CH1&CH2	CH1&CH2
		CH3&CH4	
		CH5&CH6	
		CH7&CH8	
Exit			
System	Language	English	English
		Traditional Chinese	
		Simplified Chinese	
	Color Bar	Off/On	Off
	OSD Timer	10s	10s
		20s	
		30s	
	OSD Transparency	Off	Off
		25%	
		50%	
	OSD H Position	0 – 100	50
	OSD V Position	0 – 100	50
Firmware Version			
Reset	Off/On	Off	
EXIT			

Picture

You will be allowed to adjust basic image settings such as the **brightness, contrast, saturation, tint** and **sharpness**.

Advanced settings are **HDMI RGB range, color space, gamma correction, high dynamic range (HDR), back light level, and color temperature**.

Brightness

Adjust the brightness of the screen from 0 – 100.

Contrast

Adjust the contrast of the screen from 0 – 100.

Saturation

Adjust the saturation of the screen from 0 – 100.

Tint

Adjust the tint of the screen from 0 – 100.

Sharpness

Adjust the sharpness of the screen from 0 – 100.

RGB Range

This set the RGB Range.

RGB Full (0-255): PC Monitor

RGB Limited (16-235): Standard or HD TVs

HDMI EDID

The EDID learning function is only used when you experience any failures in playing audio and video correctly. You will be able to force the monitor's receiving resolution by setting the EDID to either 2K or 4K so that the connected HDMI source outputs the maximum resolution defined in EDID.

Color Space

Select an option from the list below to provide details of the color primaries for interpretation of XYZ color space.

- Native
- REC709
REC709 is the standard camera encoding color space for HDTV established by International Telecommunication Union in 1990.
- DCI-P3

Gamma

This sets the gamma correction for the source of input; the smaller the gamma, the brighter the screen and vice versa.

- OFF
- 1.8 (MAC OS)
- 2.0
- 2.2 (Windows)
- 2.35

HDR

HDR is a new TV video standard that generates higher contrast and wide-gamut images and therefore, an HDR monitor is capable of displaying more colors and details of an image than the regular ones.

Back Light

Adjust the back light level from 0 – 100.

Color Temperature

Select a color temperature for your scene. Available color temperatures are listed as follows:

- 3200°K
- 5500°K (Desktop publishing or printing)
- 6500°K (Usually for ordinary PC use)
- 7500°K

- 9300°K (TV pictures)
- User Color

Note: Selection of the User Color mode allows you to manually set the color temperature by adjusting the Red Gain, Green Gain, Blue Gain, Red Offset, Green Offset and Blue Offset.

Marker

Aspect ratio is a crucial element in video shooting and it is defined as the proportion of the width and height of any image. You can use different aspect ratios in your video. Therefore, in order to know what will be in frame at different aspect ratios, during video production, you can turn on the monitor's aspect marker (a.k.a. guide frame) so that you can record the entire screen while still knowing where the cut-off will be by putting a mat over it.

Center Marker

The Center Marker, if turned on, will place a crosshair in the middle of the screen.

Center Marker Size

The Center Marker size can be set to small, medium or large.

Aspect Marker

Sets the aspect marker display at the aspect ratio selected from the list below:

- OFF
- 16:9
- 1.85:1
- 2.35:1
- 4:3
- 3:2



Safety Marker

This sets the safety zone display, which is the standard viewing range of the recorded video.

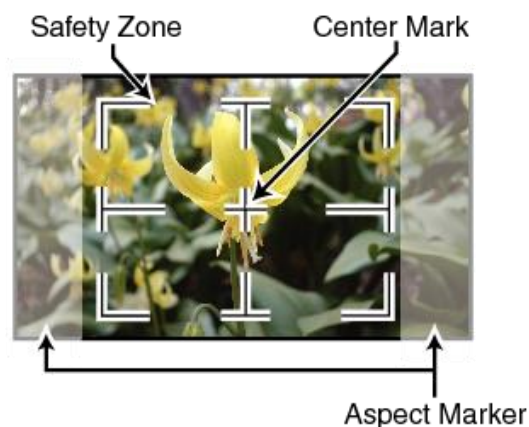

The options are listed as follows:

- OFF
- 95%
- 93%
- 90%
- 88%
- 85%
- 80%

Marker Color

The user is also allowed to apply different colors to the aspect marker. The five available marker colors are **Red, Green, Blue, White** and **Black**.

Thickness

This sets the aspect marker thickness ranging from 1 to 15.

Function

This allows the user to set advanced settings for the monitor, such as the scan mode, the aspect ratio, overscan mode, check field, zoom, and etc. Details of how these functions can be configured are described as follows:

Scan

This sets the monitor's scan mode.

Zoom: Enlarge the original image according to the [zoom ratio](#) of the monitor.

Aspect: Display the image according to the [aspect ratio](#) of the monitor.

Pixel to Pixel: Display the original image resolution without scaling to match a certain resolution or an aspect ratio. For example, when the resolution of the input video is 1920x1080 but the monitor's resolution is only 1280x800, only area equivalent to 1280x800 out of 1920x1080 will be displayed.

Aspect

The aspect control allows you to manually set the aspect ratio of the monitor. You should choose the aspect ratio of your screen to match that of the input video in order to achieve the best viewing experience. Views of different aspect ratios are shown in the diagram below.

Note: Aspect ratio control is disabled if the scan mode is set to pixel to pixel.



full screen



2.35:1



1.85:1



16:9



4:3



3:2

Overscan

If enabled, the image rendered on the display will be larger than the physical area of the screen, creating a cropped image on the monitor screen.

Check Field

The check field function offers the user Red-Only, Green-Only, Blue-Only and **Mono** modes for screen calibration should you require them.



First turn on the color bar, then turn on the single color mode in the check field as this allows you to do the screen calibration by adjusting the brightness, contrast, saturation, tint and sharpness.

Zoom

The zoom function allows you to enlarge the image by a certain percentage (10 – 40%).

Note: Zoom control is disabled if the scan mode is set to pixel to pixel.

False Color

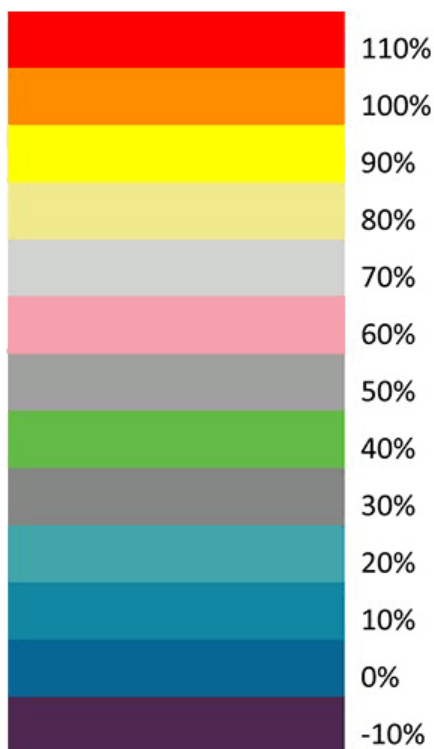

Also known as the exposure assist, once enabled, the false color feature will change colors of the elements of the image based on the brightness value. This allows the user to use the monitor’s exposure function to achieve proper exposure without the use of costly external equipment.

To best utilize this feature, you must first understand the color chart below. The color chart is like a color scale. The exposure level is represented by different colors which correspond to the respective luminance of the pixels as displayed on the monitor. The correct exposure ranges from 10 – 100%. Anything below 10% is regarded as underexposed and if exposure exceeds 100%, it is deemed overexposed.

Underexposure and overexposure will lead to loss of details in an image.

For example, areas with exposure level of 56IRE when applied the false color will be shown as pink color on the monitor. Therefore, as you increase the exposure, that area will change color to grey, then yellow and finally to red if overexposed. Blue indicates underexposure.

An example of an original image with the false color applied is shown on the left of the image below.

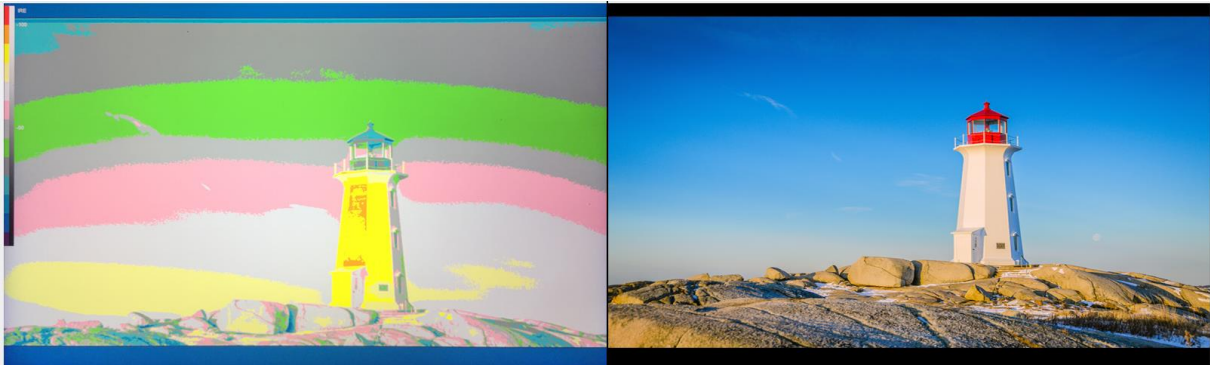

False Color Table

This enables/disables false color chart on the screen. A sample of the chart is shown below.

	100 to 109 IRE
	93 to 100 IRE
	84 to 93 IRE
	77 to 84 IRE
	58 to 77 IRE
	54 to 58 IRE
	47 to 54 IRE
	43 to 47 IRE
	24 to 43 IRE
	15 to 24 IRE
	8 to 15 IRE
	2 to 8 IRE
	-7 to 2 IRE

Audio

Volume

The Volume option sets the audio level of the audio output.

Audio Out

Select an embedded audio pair for the audio output.

- CH1&CH2
- CH3&CH4
- CH5&CH6
- CH7&CH8

System

Language

The available languages are **English, Traditional Chinese** and **Simplified Chinese**.

Color Bar

Enable/Disable color bar.

OSD Timer

This sets the OSD menu's ON time; the OSD menu will be automatically turned off after the timer times out.

- 10s
- 20s
- 30s

OSD Transparency

This sets the OSD menu transparency. You can set the transparency level to either 25% or 50%. Disabling this option will yield an opaque OSD menu.

OSD H Position

This adjusts the horizontal screen position of the OSD menu.

OSD V Position

This adjusts the vertical screen position of the OSD menu.

Firmware Version

This displays the monitor's firmware version number.

Reset

Select **ON** to reset the monitor settings entirely.

Chapter 8. Video Streaming and Recording

The HS-2600 4K 8-Channel Portable Video Studio includes a built-in Video Streaming Server (NVS-32) allowing the user to stream and record your program at the same time. From any SDI/HDMI input sources, the Datavideo's video streaming server generates an H.264/265 encoded stream that is compliant with RTMP(S) and SRT protocols. While encoding the video at bit rates appropriate for live streaming, the Datavideo NVS-32 concurrently records a high-quality MP4 file to an SD card.

Note: The built-in video streaming server will be referred to as NVS-32 in the rest of this chapter.

8.1 Streaming Network Connection and Device Search

This section details how to connect the NVS-32 to a network with or without a DHCP server, and describes how to acquire the NVS-32's IP address.

DHCP

Follow the following procedure to scan your DHCP network for connected NVS-32 devices.

Note: By default, the NVS-32 uses DHCP to connect and will be assigned an IP address upon connection to a DHCP server.

1. Connect the NVS-32's LAN/DVIP port to a DHCP server via an Ethernet cable.
2. Turn on the HS-2600's power and the NVS-32 will also be turned ON in DHCP by default.
3. Connect the laptop to the same network that the NVS-32 is connected to.
4. Use [DVIP Configuration Tool](#) to search for NVS-32's IP address.

DVIP/LAN

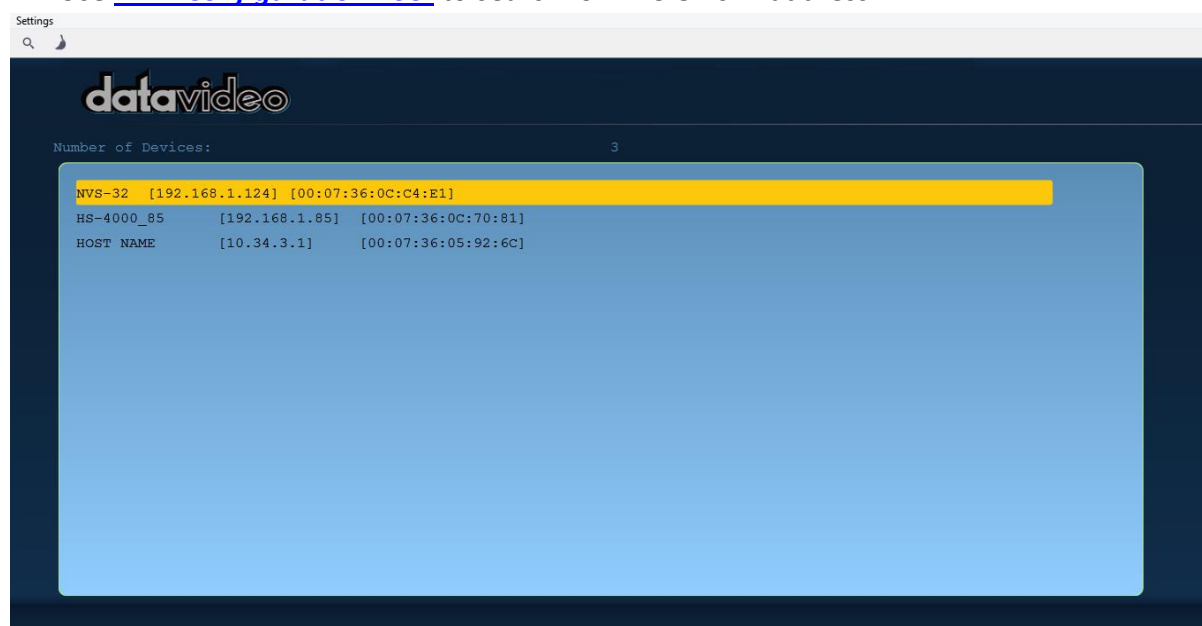
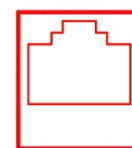

Static IP

With DHCP disabled, the NVS-32 will not be assigned an IP address upon connection to a DHCP server. As such it is recommended that you manually assign a static IP address to the device.

Static IP Address

Static IP is primarily used in point-to-point connection, allowing you to access the NVS-32 directly from the PC. To assign a static IP address to the NVS-32, please follow the steps outlined below:

1. Connect the NVS-32's LAN/DVIP port to a DHCP server via an Ethernet cable.
2. Turn on the HS-2600's power and the NVS-32 will also be turned ON in the DHCP mode by default.
3. Search for the NVS-32 device according to the method as detailed in the previous DHCP section. Once found, log in to the user interface on the web browser.
4. Open the Network page by clicking the "Network" tab.
5. Disable DHCP.
6. You will be allowed to manually enter a static IP address once DHCP is disabled. Depending on your network configuration, you will also need subnet mask, gateway IP as well as the DNS information.

DVIP/LAN

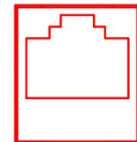

The screenshot shows the '4K STREAMING ENCODER' web interface. The 'Network' tab is selected in the left sidebar. The main content area displays the following configuration:

DHCP	<input type="checkbox"/> OFF
IP Address	192.168.1.100
Network Mask	255.255.255.0
Gateway	192.168.1.1
Primary DNS	192.168.1.1
Secondary DNS	8.8.8.8
MAC Address	aa:bb:cc:dd:ee:ff

8.2 Web User Interface

By now, we have obtained the NVS-32's IP address. Enter it into the address bar of a browser then hit **ENTER**. Log in with the user name and password provided below.

User name: admin

Password: admin

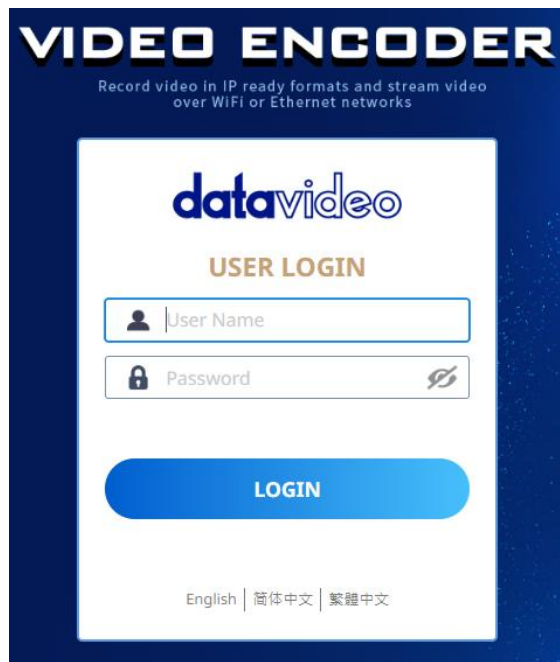

On the web user interface, the setting options are in the main area with device information on the left and device status at the top right corner.

Tabs to access different pages.

Click for a reduced view

Status Pane

The screenshot shows the DataVideo 4K Streaming Encoder web interface. At the top left is the 'data video' logo. The main header includes '4K STREAMING ENCODER' and 'Encoder'. On the right of the header, there is a language dropdown set to 'English', a 'Logout' button, and a status bar showing 'STM + REC', a 'Stop' button, and 'Video Input: 1080p 30hz'. A left sidebar contains navigation tabs for 'Encoder', 'Network', and 'System', with 'Encoder' selected. Below these tabs is an 'Information Pane' showing 'Main Stream' (Resolution: 1920x1080p, Video Bitrate: 7 mbps) and 'Record' (Resolution: 1080p, Video Bitrate: 50 mbps, File Capacity: 35 GIB free of 50 GIB, Duration Time: 12:12:12). The main configuration area is divided into 'MAIN STREAM' and 'RECORD' sections. The 'MAIN STREAM' section includes a 'Main Stream' toggle (ON), 'Encoding Format' (H.265), 'Resolution' (1920x1080p), 'Video Bitrate' (7 mbps), 'Key Frame Interval' (1s), and 'Protocol' (SRT Listener). The 'RECORD' section includes 'Encoding Format' (H.264), 'Resolution' (1920x1080p), and 'Video Bitrate' (50 mbps). Below these sections are input fields for 'SRT URL' and 'SRT Latency' (1000). At the bottom of the configuration area are 'Discard' and 'Apply' buttons. The footer contains the copyright notice: 'Copyright © 2023 Datavideo all rights reserved.' and 'FW Version: 0.5.19'.

Information Pane

Main configuration area

Status Pane

The status pane is described below.

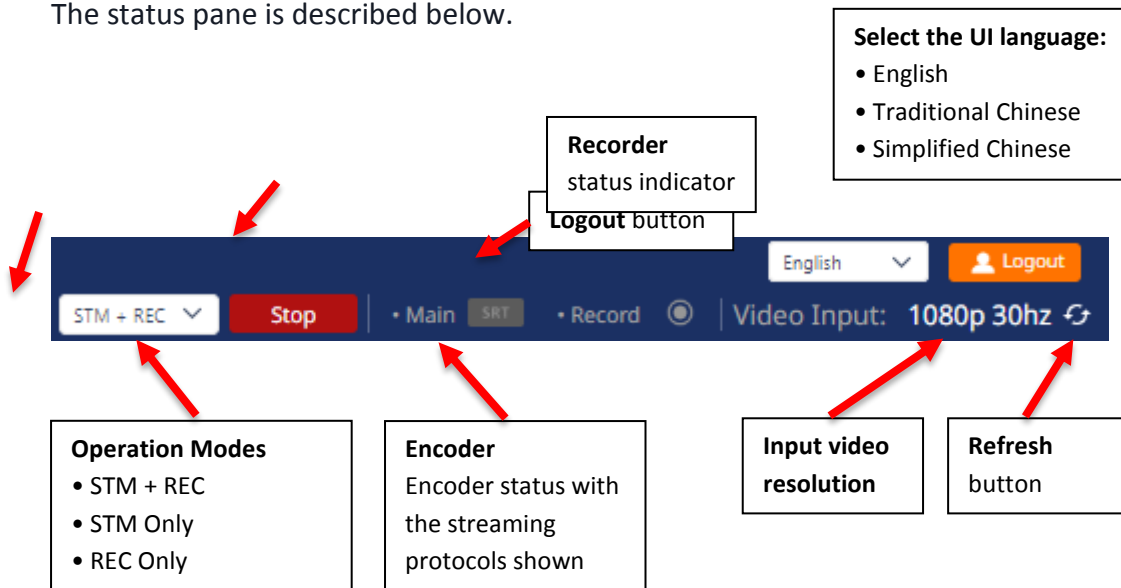

The NVS-32 offers the following operation modes:

- **STM + REC:** Streaming encoder and recorder are enabled at the same time.
- **STM Only:** Only streaming encoder is enabled.
- **REC Only:** Only recorder is enabled.

which can be selected from the drop-down list shown above. Regardless of the mode selected, you will be allowed to customize stream and record settings.

The streaming encoder settings consist of [Encoding Format](#), [Resolution](#), [Video Bitrate \(mbps\)](#), [Key Frame Interval](#) and the [Protocol](#).

Two streaming protocols are offered and they are [RTMP](#) and [SRT](#). See [Section 8.3](#) for details.

The recorder settings are simply [Encoding Format](#), [Resolution](#) and [Video Bitrate \(mbps\)](#).

Click the “**Start**” button to start operating in the selected mode. Click the “**Stop**” button to end device operation.

Note: The status indicators should be turned on after the device starts operating in the selected mode. A flashing indicator indicates that device is initializing. A solid color indicator means that the device is functioning well. You should check the device for errors if the indicator flashes three times then turned off. The error code and the suggested solution will be shown in the Message box on the [Information](#) pane.

You can also select the UI language. The currently available languages are English, Traditional Chinese, and Simplified Chinese.

The input video resolution is also shown, however, the NVS-32 web UI does not update itself so to learn the latest device status, please refresh the page manually on a regular basis.

Information Pane

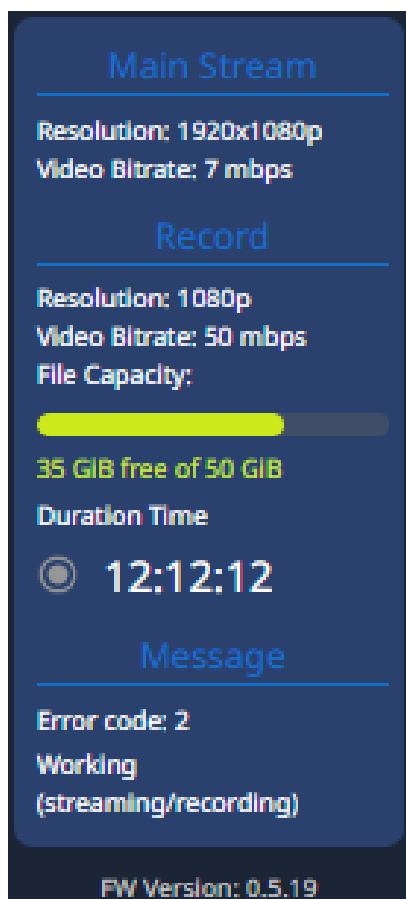

The information pane displays the video stream's resolution and video bitrate (encoder and recorder), SD card information (total disk size, remaining capacity and length of the video recorded), error messages (shown in orange) and device status (shown in white).

The firmware version is shown at the bottom.

The error codes are listed in the table below.

Error	Code	Descriptions	Impact
No Error	000	No error	
Parameter Error	254	Stream parameters error	Stream Only
Internet or Server Error	253	Internet disconnected, poor connection, server handshake error or disconnected from server	Stream Only
Write Packet Error	251	Unable to write packets to server; restore by reconnecting	Stream Only
HDMI Unplugged	250	HDMI input disconnected or no HDMI signal	Record/Stream
Incorrect Resolution or Low Frame Rate	249	Incorrect resolution/frame rate	Record/Stream
Used H.265 video encoding during RTMP(S) streaming	248	H.265 not supported on RTMP	Stream Only
Used H.264 video encoding during 4K streaming	246	H.264 not supported while streaming 4K 50/59/60 video	Stream Only
CODEC not supported	245	Unknown CODEC used	Record/Stream
No SD Card	244	SD card not detected	Record Only
CODEC Fatal Error	243	CODEC fatal error	Record/Stream
CODEC Timing Error	242	CODEC timing error	Record/Stream

CODEC Unknown Error	241	CODEC unknown error	Record/Stream
SD Card Write Error	240	SD card write error; compatibility issue	Record Only
SD Card Full	238	SD card full	Record Only
Firmware Update Failure	237	Firmware update failed	System
SD Card Format Failure	236	SD card cannot be formatted	System

The status codes are listed in the table below.

Status	Code	Descriptions	Impact
No Error	000	Record/Stream stopped without error.	
Initiating	001	Record/Stream is initializing.	Record/Stream
Working	002	Recording/Streaming in progress	Record/Stream
F/W Updating	007	Firmware is updating.	System
F/W Update Successful	009	Firmware update is successful.	System
SD Card Format Successful	010	SD card is formatted successfully.	System

Encoder

Click the **Encoder** tab to open the encoder configuration page.

First select an appropriate video bitrate mode from the **Encoder Mode** drop-down list for video streams and the recorder. The modes are high, mid and low which provide quick access to suggested video bitrate combinations across the encoder and the recorder.

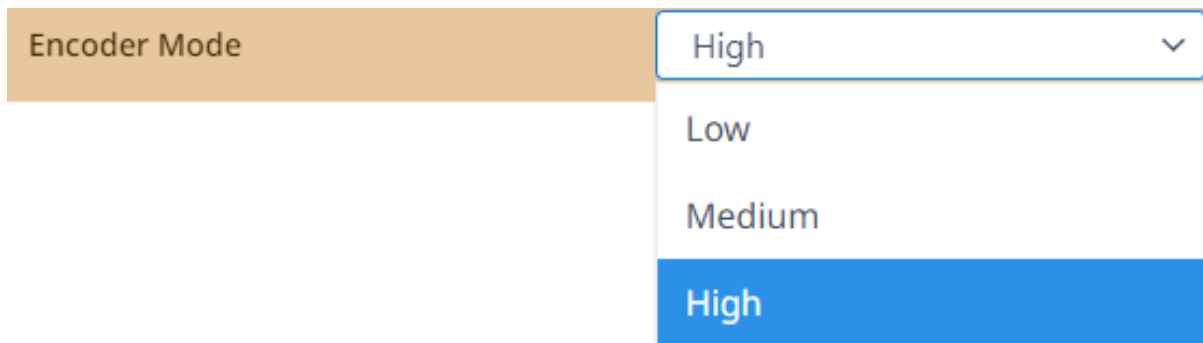

The correlated video bitrates of the encoder and the recorder in each mode are summarized in the table below:

Modes	Encoder	Recorder
Low	6 Mbps	20 Mbps
Medium	8 Mbps	30 Mbps
High	10 Mbps	40 Mbps

Please note that you can also use the [Video Bitrate](#) drop-down list to modify the video bitrate.

You can also use the Bitrate button on the front panel to switch between High, Medium and Low. See [BITRATE Button](#).

Streaming Encoder Settings

The stream settings will be described in detail below.

Encoding Format

First select either the H.264 or H265 video codec after you've turned on the streaming server.

If you're working with high-resolution video formats such as 4K and 8K, H.265 is the better choice due to its improved compression efficiency. However, if you're working with older devices or platforms that may not support H.265, or if you're streaming video over a limited bandwidth connection, H.264 may be the better option.

Resolution

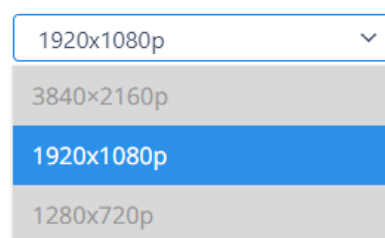

The first step of encoder setup is to adjust the image size. It is best to either match your original video source or scale it down. For example, capture at HD 720 and stream at HD 720. Or capture at 4K 2160 and stream at Full HD 1080.

You should never be scaling up and streaming at a higher resolution than your original video source. For example, it does not make sense to capture at 720 and stream at 1080. Note that you will also have no gain in quality and you are using more bandwidth than is necessary for your viewers.

You should also be aware that higher resolutions require greater processing power to encode the stream. Attempting too high of a resolution on too little processing power can result in degraded image quality and corrupted or interrupted streams or recordings.

Please note that the NVS-32 does not support interlace video, so you should always avoid setting the resolution of your switcher's output video to 1080i/60/59.94/50.

Video Bitrate

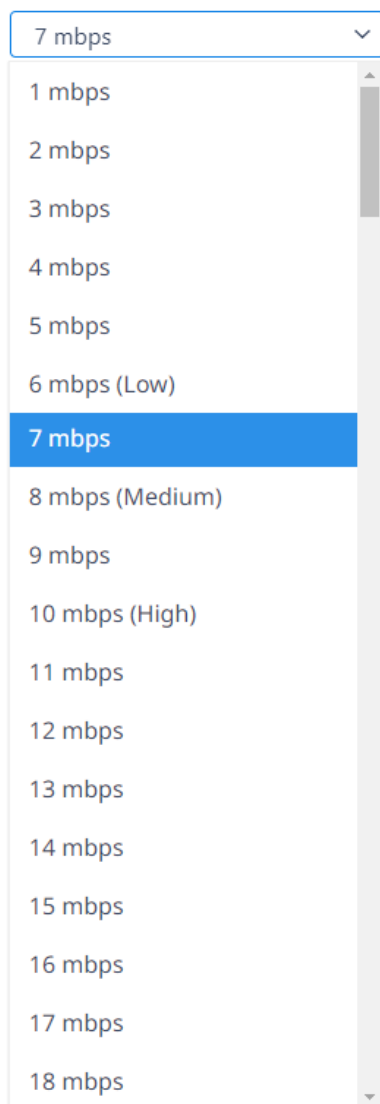

The bitrate of the video specifies the amount of information stored in the video. The higher the bitrate, the clearer the video will be. However, when choosing your encoding settings for streaming, you should first check your available upload bandwidth. A good rule of thumb is for the bitrate of your stream to use no more than 50% of your available upload bandwidth capacity on a **DEDICATED** line. For example, if the result you get from a speed test shows that you have 20Mbps of upload speed available, your combined audio and video bitrate should not exceed 10Mbps.

Keyframe Interval

The keyframe interval in video encoding determines how often complete frames, called keyframes, are inserted into a video sequence. For live stream, a two-second keyframe interval is optimal, so if your frame rate is 30 fps, the keyframe interval would be every 60 frames or 2 seconds.

Note: A short keyframe interval can result in stuttered playback.

Protocol

The NVS-32 offers the user two streaming protocols which are **RTMP** and **SRT**.

Please note that when streaming, the NVS-32 converts video into data, which are sent across an IP network. High bitrates consume more bandwidth across the IP network. In a gigabit office LAN, high bitrate may not be a concern and Speed/Bandwidth is therefore not a limitation in an NVS-32 application environment.

If your available bandwidth is limited, you should reduce both your resolution and your bitrate accordingly. A good rule of thumb is for the bitrate of your stream to use no more than 50% of your available upload bandwidth capacity on a dedicated line. For example, if the result you get from a speed test shows that you have 20Mbps of upload speed available, your combined audio and video bitrate should not exceed 10Mbps.

RTMP(S)

Real-Time Messaging Protocol (RTMP) is a communication protocol for streaming audio, video and data over the Internet. See the following for descriptions of the settings.

RTMP(S) URL: Enter the RTMP URL obtained from any live streaming platform.

Note: The NVS-32 supports RTMP(S) Publish only and not RTMP(S) Local.

Stream Name: Enter the stream name or key provided by the live streaming platform that you will be using.

Lastly, enter your RTMP server **account name** and **password**.

SRT

Read this section to learn how to link between an SRT source and destination devices.

Caller and listener modes work together to establish the SRT link between source and destination devices. Simply set one device to listener mode and the other the caller mode which is entirely arbitrary.

If Caller is selected, enter the IP address of the destination device (decoder) in the **Caller IP/URL** field and a port number in **SRT Port**. The SRT port number ranges from 1024 to 65535; the default is 10001. Please note that if your SRT stream destination is a CDN or media server, the IP address and the port number should be provided by the service provider. Lastly, enter a name for your video stream in **Stream ID**.

If Listener is selected, simply enter an SRT port number that you intend to use on this device for the SRT stream.

Latency sets the maximum buffer size for managing SRT packets; the value ranges from 20 to 8,000 ms. The default is 1000 ms.

Recorder Settings

The record settings will be described in detail below.

Encoding Format

See [descriptions](#) in the encoder section.

Resolution

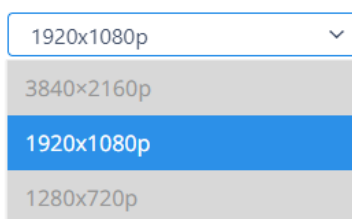

1920x1080p

3840x2160p

1920x1080p

1280x720p

Recording resolution is the number of pixels (dots) used to create an image. Higher resolutions use more pixels to create an image. This means that greater amounts of detail can be expressed in the image, but larger file sizes and a greater amount of storage (i.e. hard drive space) are required to save the images or video.

Video Bitrate

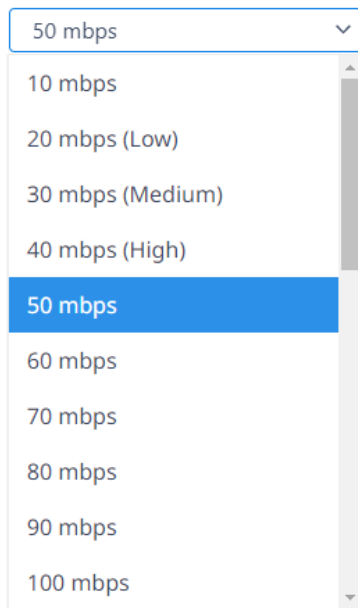

A dropdown menu for selecting video bitrate. The menu is currently open, showing a list of options from 10 mbps to 100 mbps. The option '50 mbps' is highlighted in blue. The menu is set against a white background with a light blue border.

50 mbps
10 mbps
20 mbps (Low)
30 mbps (Medium)
40 mbps (High)
50 mbps
60 mbps
70 mbps
80 mbps
90 mbps
100 mbps

The bitrate of the video specifies the amount of information stored in the video. The higher the bitrate is, the clearer the video is.

Network

The network page allows the user to choose to use DHCP or Static IP to connect. You can also view the current time retrieved from an RTC server on this page.

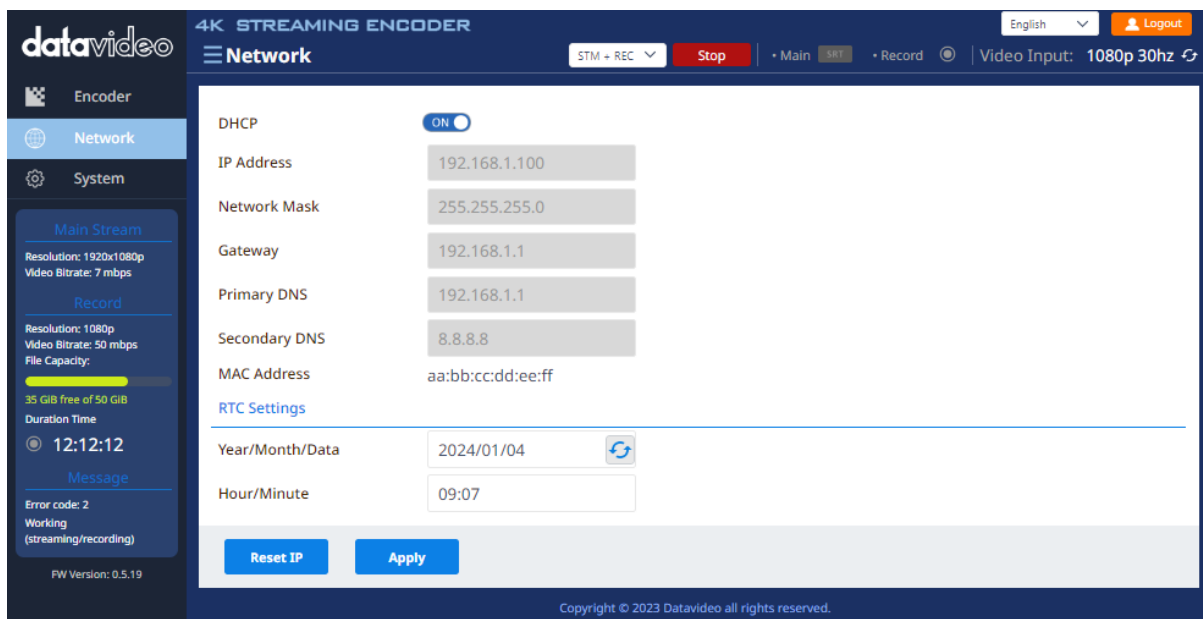

The screenshot shows the 'Network' configuration page of a '4K STREAMING ENCODER'. The page is dark-themed with a blue sidebar on the left containing navigation options: Encoder, Network (selected), and System. The main content area is white and contains the following settings:

- DHCP:** A toggle switch is turned ON.
- IP Address:** 192.168.1.100
- Network Mask:** 255.255.255.0
- Gateway:** 192.168.1.1
- Primary DNS:** 192.168.1.1
- Secondary DNS:** 8.8.8.8
- MAC Address:** aa:bb:cc:dd:ee:ff
- RTC Settings:**
 - Year/Month/Date:** 2024/01/04
 - Hour/Minute:** 09:07

At the bottom of the configuration area, there are two buttons: 'Reset IP' and 'Apply'. The top right of the page shows 'English' and 'Logout' options. The bottom right corner of the page has the copyright notice: 'Copyright © 2023 Datavideo all rights reserved.'

DHCP Enable/Disable

Enable DHCP to connect to a DHCP server which should assign an IP address to your device. To use a static IP address, simply disable DHCP then enter your network connection settings which include the IP address, network mask, gateway IP and DNS information.

The device's MAC address is shown but cannot be modified.

Please note that the NVS-32 uses DHCP to connect by default. Click the **Reset IP** button to restore default network settings and the **Apply** button to save.

RTC Settings

Date and time are retrieved from the RTC server. Click the **Refresh** button  to update the current time.

System

On the system page, you will be allowed to modify the **device name**, perform a **firmware upgrade**, change the **login information** and **format the SD card**.

The system page is shown in the diagram below.

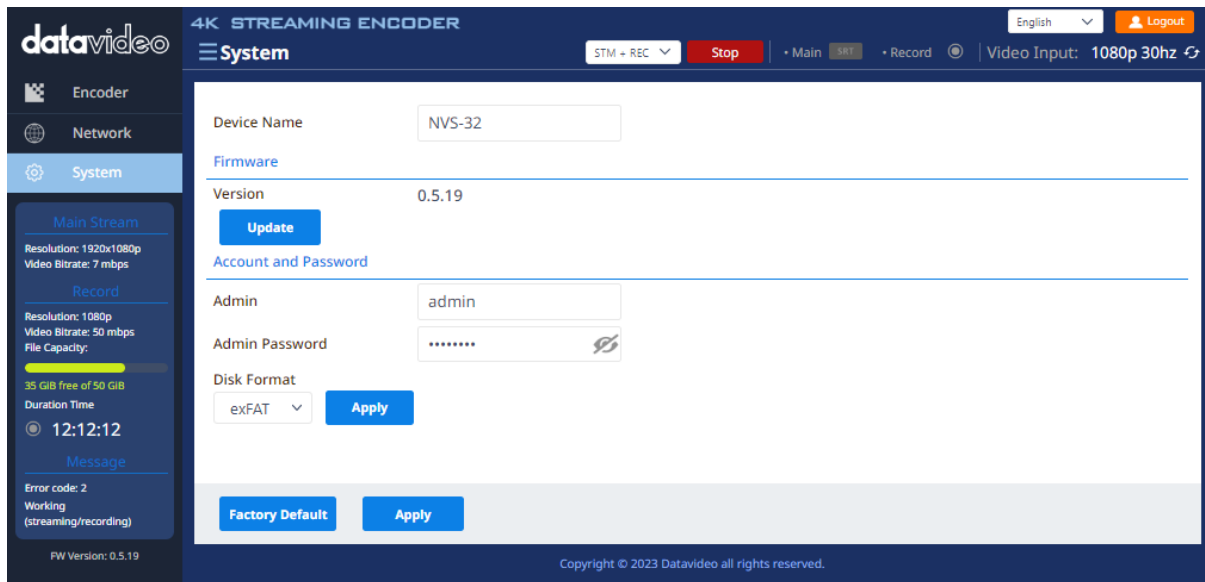

Device Name

Enter a preferred name in the textbox then click the **Apply** button to save the change.

Account and Password

Enter preferred username and password in the admin and admin password textboxes respectively. Click the **Apply** button to save the change.

To reset the login credentials to default username (admin) and password (admin), simply click the **Factory Default** button.

Alternatively, see [8.5 Resetting Login Credentials](#) to reset using the stream control buttons.

Disk Format

Before you start recording, you should format the SD card to either FAT32 or exFAT. Comparison between exFAT and FAT32 is provided in the table below.

FAT32	exFAT
Best suited for small drives.	Works well on large drives.
Maximum file size 4GB and partition size 8 TB.	No limit on file size, and partition size.
FAT32 is an older type of file system introduced in Windows 95.	exFAT replaces FAT32, and supports cross-platform scenarios.
Better compatibility	Not used often.

Note that you should only use Class 10 SD card or above. See [Appendix 4 Recommended SD Cards](#) for a list of SD cards recommended by Datavideo.

8.3 Video Streaming Guides

Use the guides in this section to learn about publishing streams to various media.

RTMP(S)

Real-Time Messaging Protocol (RTMP) is a communication protocol for streaming audio, and video over the Internet. **Please note that the NVS-32 does not support RTMP(S) local.**

In this section, we will show you how to set up an **RTMP(S)** stream to **Facebook** and **Youtube**. The step-by-step setup is outlined as follows:

Facebook

1. Open Facebook Live by clicking the link below then click “Go Live Now”.

<https://www.facebook.com/formedia/solutions/facebook-live>

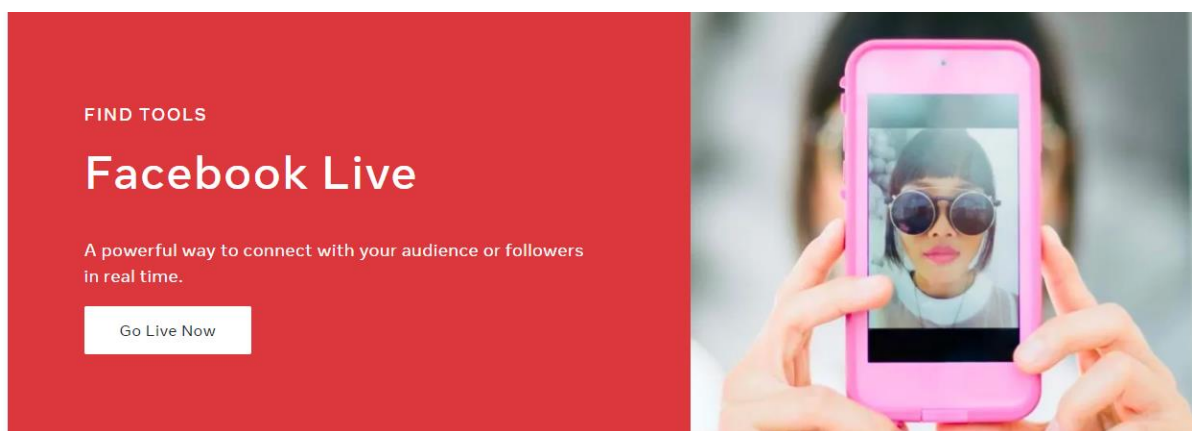

Please note that you can also link to Facebook Live from your Facebook Personal Page or Facebook Fan Page by clicking “Live Video” as depicted below.

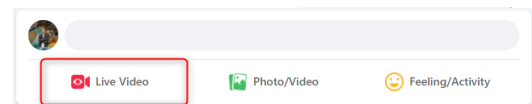

2. Select “Go live”.

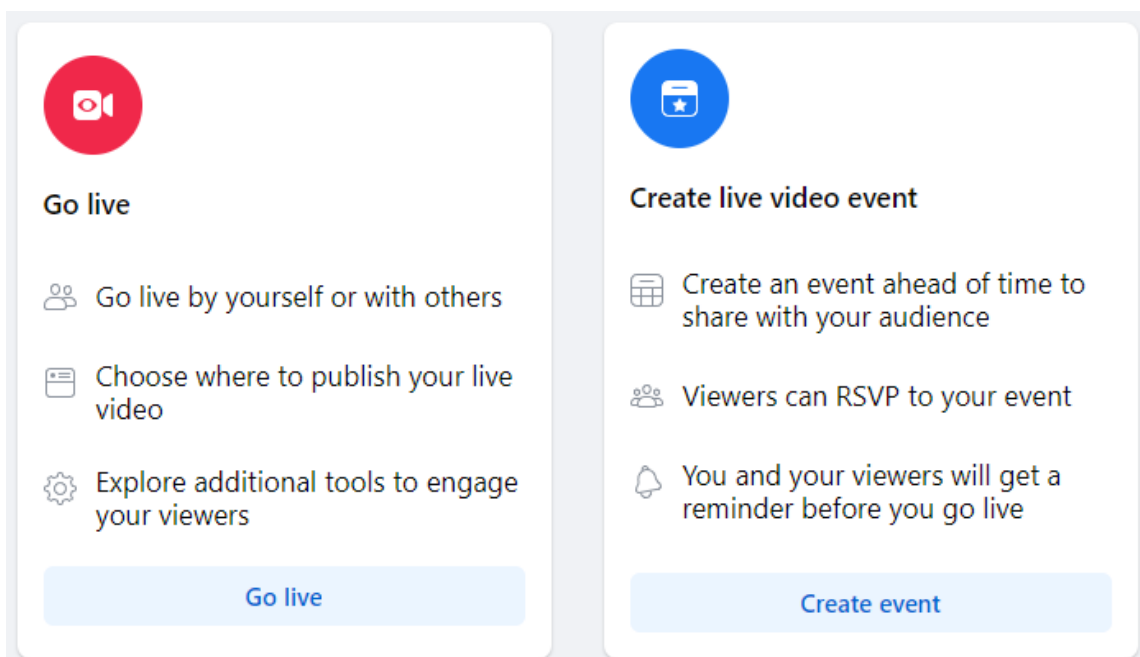

3. Select “Streaming software” where you will be able to find the server URL and the stream key. If you’d like, you can also enter the title and descriptions about this live stream.

Select a video source ?

Webcam Streaming software

Preview streams via streaming software are subject to our [Community Standards](#) and Facebook Live policies, and may be retained by Facebook for review and enforcement.

Streaming software setup

Copy and paste the stream key into your streaming software.

Stream key

FB-370758482040289-0-AbwT_NpvFKtprYPK Copy

This stream key is valid until you log out of Facebook. Once you start to preview the broadcast you have up to 4 hours to go live.

Advanced Settings

Persistent stream key

This can be reused every time you go live. You can only broadcast one live video at a time with your persistent stream key.

Backup stream

Once a backup stream is added to your live video, it cannot be removed. It will not affect your stream if you choose not to use it.

Server URL

rtmps://live-api-s.facebook.com Copy Ingest URLs

This may be referred to as "URL" or "Address" in your streaming software.

Add post details

Share to story

Your live video will also be added to your story.

Title (optional)

Description

4. Enter “Server URL” and “Stream key” in the RTMP(S) URL and Stream Name textboxes respectively. In this example, the server URL is **rtmps://live-api-s.facebook.com:443/rtmp/** and the stream key is **FB-370758482040289-0-AbwT_NpvFKtprYPK**. Also remember to enter your Facebook account information.

Protocol

RTMP

RTMP(S) URL

rtmps://live-api-s.facebook.com

Stream Name

FB-370758482040289-0-AbwT_!

Account

Account

Password

Password

- Click the **Apply** button to save the RTMP(S) stream settings. At the top right corner of the web UI, the stream channel should be updated to show RTMP(S) mode.

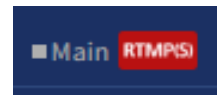

- As shown in the diagram below, you can also preview the live camera video on Facebook Live.

Select a video source ?

Webcam Streaming software

Preview streams via streaming software are subject to our [Community Standards](#) and Facebook Live policies, and may be retained by Facebook for review and enforcement.

Streaming software setup

Copy and paste the stream key into your streaming software.

Stream key

FB-370758482040289-0-AbwT_NpvFKtprYPK Copy

This stream key is valid until you log out of Facebook. Once you start to preview the broadcast you have up to 4 hours to go live.

Advanced Settings ▾

Video

Expand video ↗

Event logs

Add post details

Share to story Your live video will also be added to your story.

Title (optional)

Description

👤 📍 😊

- Before you activate the live stream on Facebook, on the left pane of Facebook Live, choose where and when you want to post your live video as well as the audience. Lastly, click the “Go live” button to start livestreaming of your camera video on Facebook.



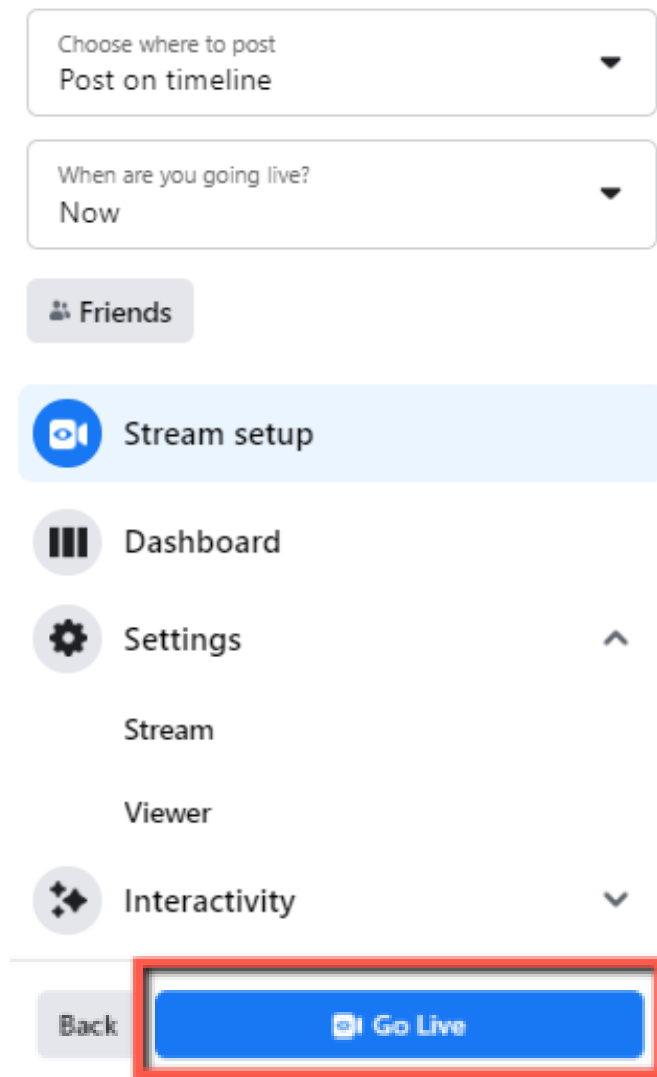

8. To end the live stream, simply click “End Live Video”.



Youtube

1. Open the Youtube Live Control Room by clicking the link below:

https://www.youtube.com/live_dashboard

Alternatively, log in to your Youtube account, locate and click the camera icon at the top right corner, then select “Go live”.

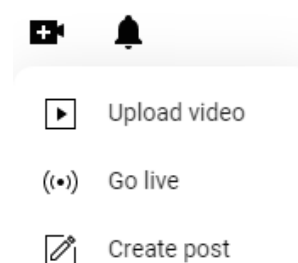

2. As soon as the “**Youtube Live Control Room**” opens, select “**Right Now**”.

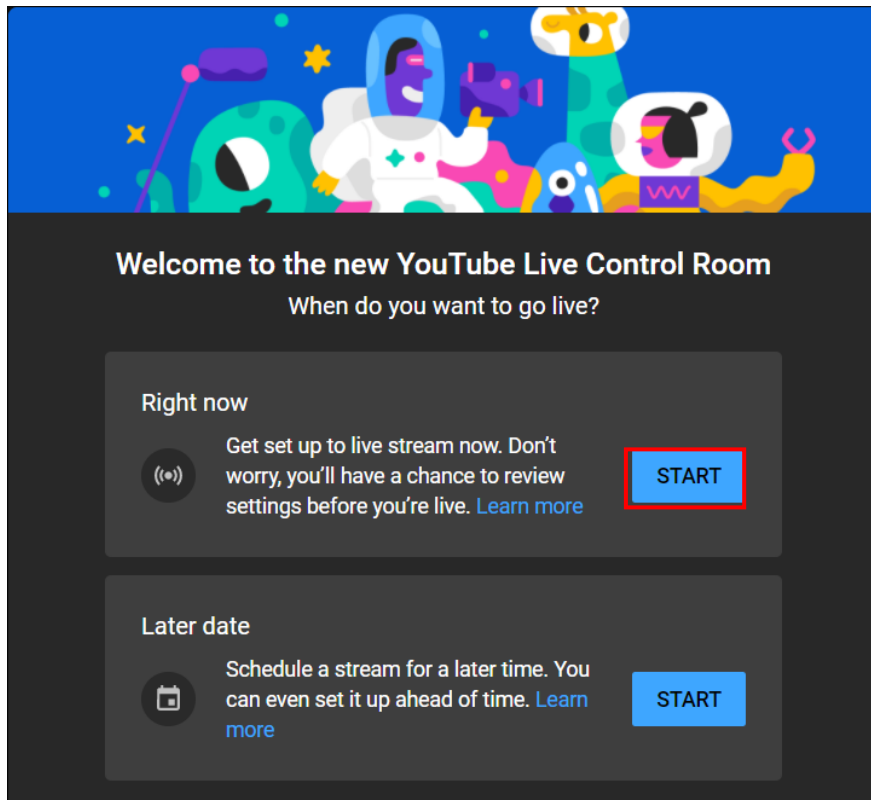

3. Select **Streaming Software**.

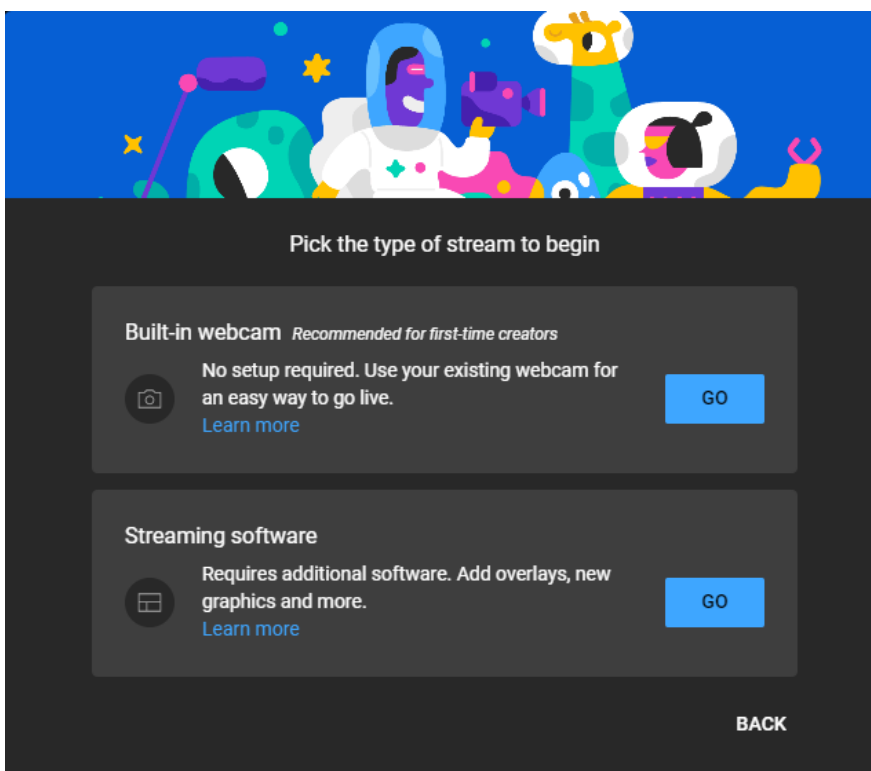

4. You will be able to find the server URL and the stream key in **Stream settings** pane of the Youtube Live Control Room. If you'd like, you can also click **Edit** to modify the stream information such as title and descriptions.

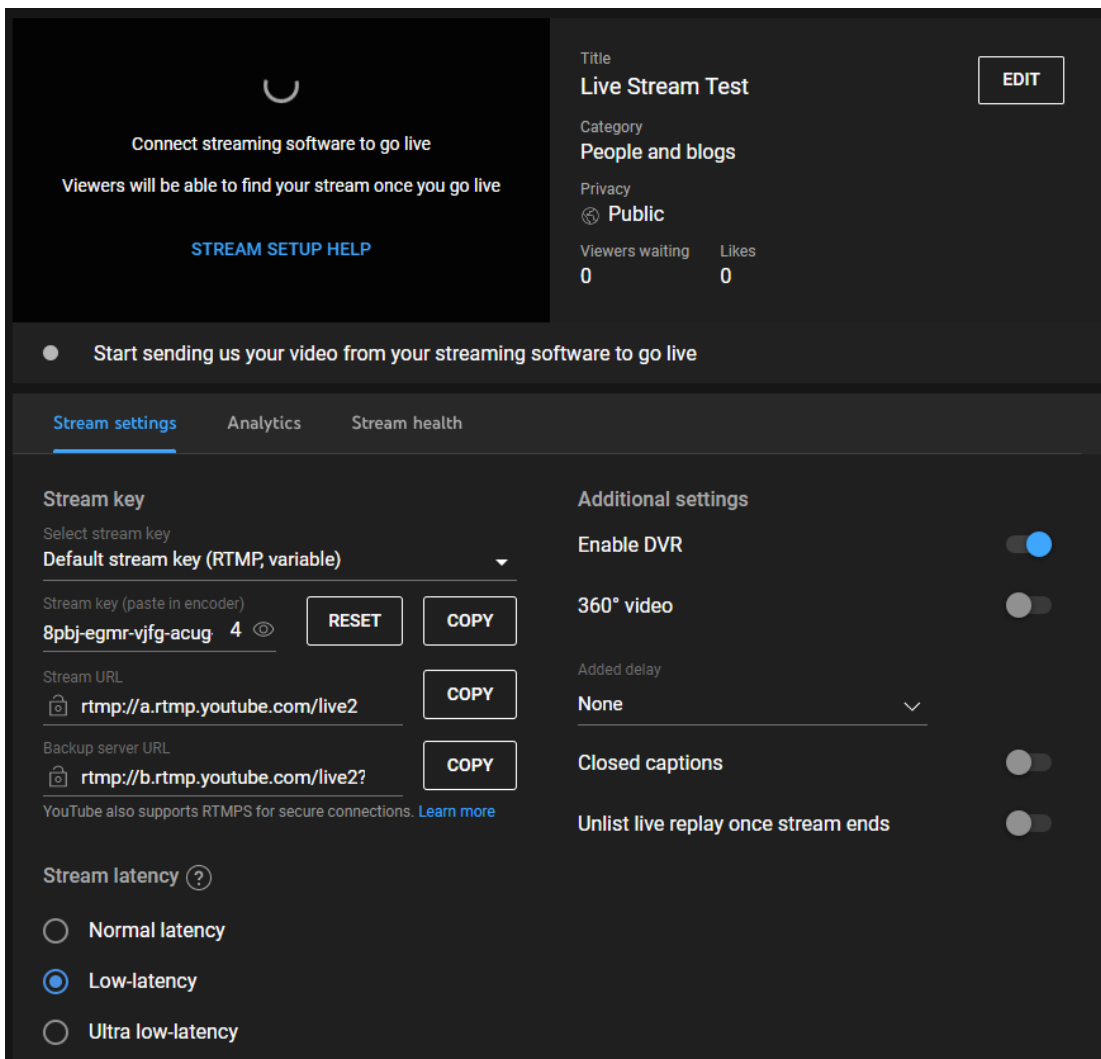

5. Enter “Server URL” and “Stream key” in the RTMP(S) URL and Stream Name textboxes respectively. In this example, the server URL is **rtmp://a.rtmp.youtube.com/live2/** and the stream key is **8pbj-egmr-vjfg-acug-6vsc**. Also remember to enter your Youtube account information.

Protocol

RTMP(S) URL

Stream Name

Account

Password

6. Click the **Apply** button to save the RTMP(S) stream settings. At the top right corner of the web UI, the corresponding stream channel should be updated to show RTMP(S) mode.
7. To end the live stream, simply click “**END STREAM**” which can be found at the top right corner of the Youtube Live Control Room.

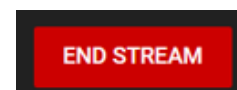
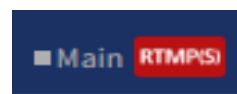

SRT



Unlike RTMP(S), we will use vMIX to playback an SRT stream on a PC. If your PC or laptop does not have vMIX installed, please visit <https://www.vmix.com/> and download the installation file then install the program.

Please note that the NVS-32/vMIX connection is bidirectional. Regardless of the caller-listener setup, either end can be the camera video source.

Listener

Open the web UI and on the **Encoder** page, select **SRT Listener** from the **Protocols** drop-down list of the encoder. Then enter the **SRT port number 9000** in the **SRT URL** textbox. Lastly click the **Apply** button to save the SRT settings and the **Start** button to activate the stream.

On the PC or laptop where the vMIX is installed, open vMIX then click “Add Input” and select “More”.

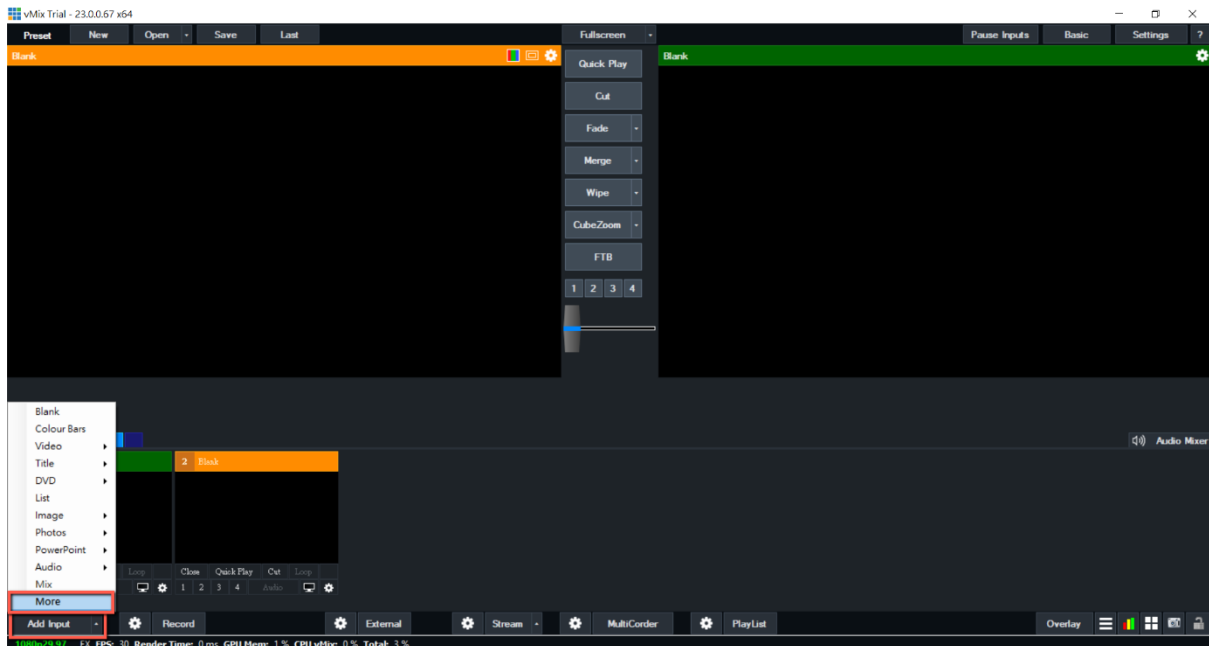

On the Input Select window, click “Stream/SRT” then select “SRT Caller” from the “Stream Type” drop-down list. After that, enter the following into the respective fields.

- Hostname: IP address of the video source which is the NVS-32 in this case.
- Port: 9000 (SRT port number ranges from 1024 to 65535.)

You can leave passphrase empty as it is not supported on the NVS-32.

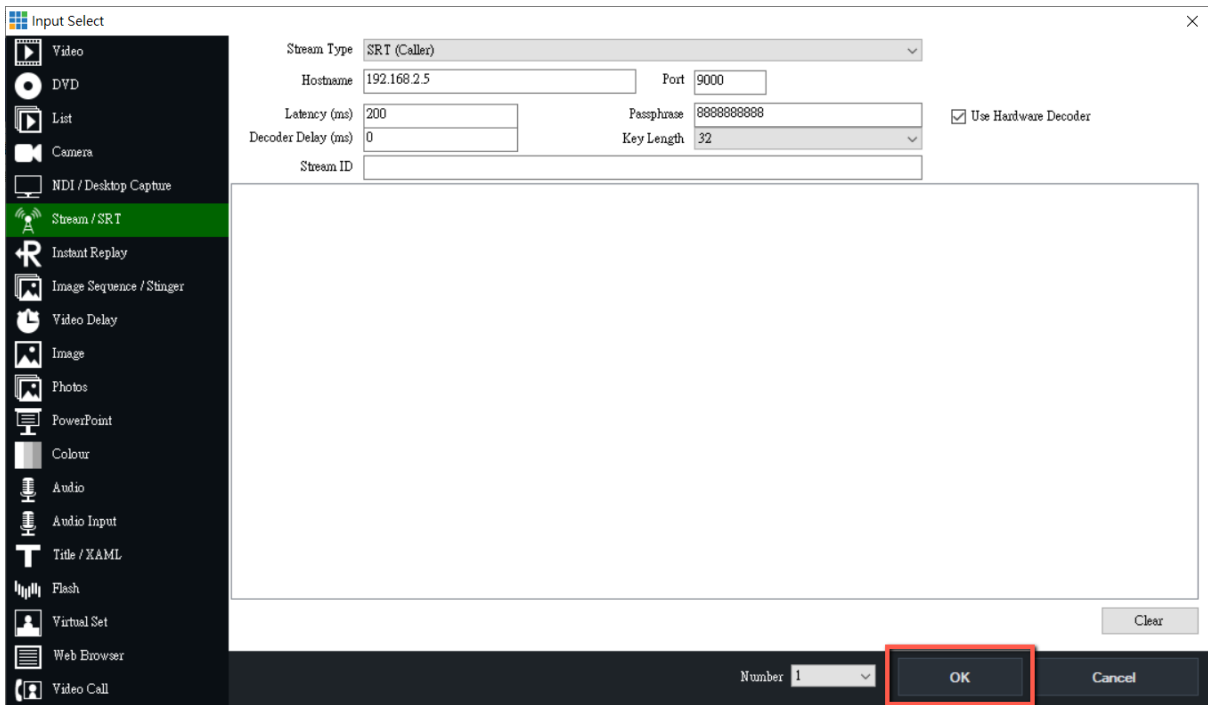

Click the “OK” button to start streaming to vMIX from NVS-32 via SRT.

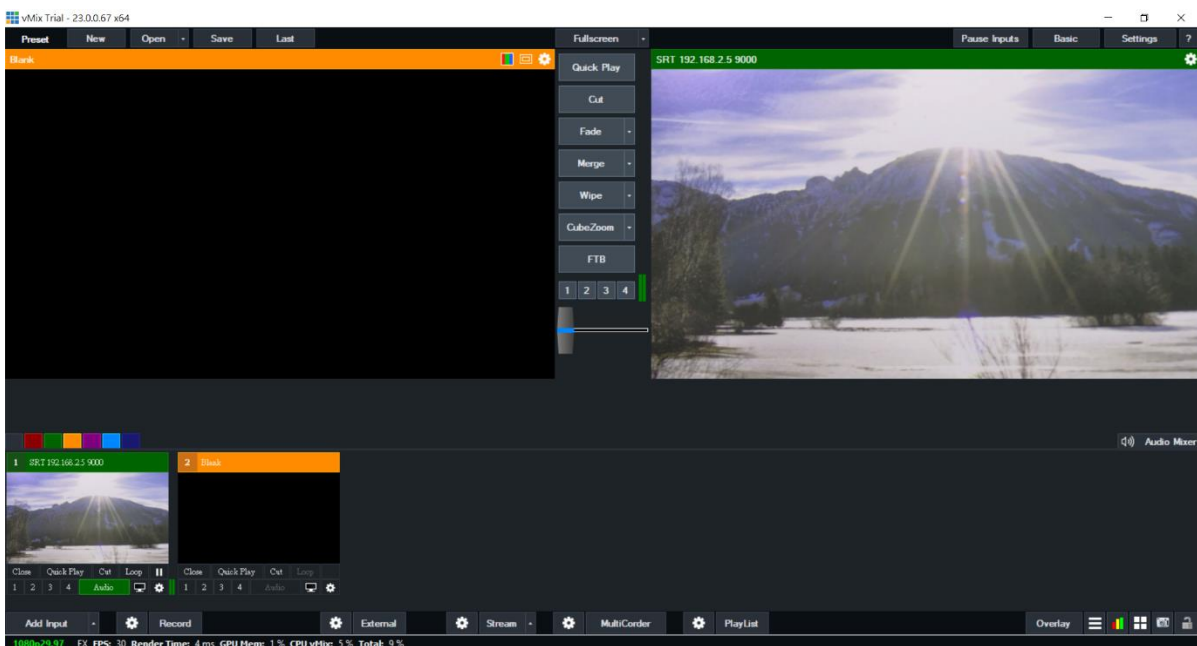

Caller

Open the web UI and on the **Encoder** page, select **SRT Caller** from the **Protocols** drop-down list of the encoder. Then enter the **SRT port number 9000** in the **SRT URL** textbox and the IP address of the destination device in the **Caller IP/URL** textbox. You can also enter a stream ID but it is entirely optional. Lastly click the **Apply** button to save the SRT settings and the **Start** button to activate the stream.

On the PC or laptop where the vMIX is installed, open vMIX then click “Add Input” and select “More”.

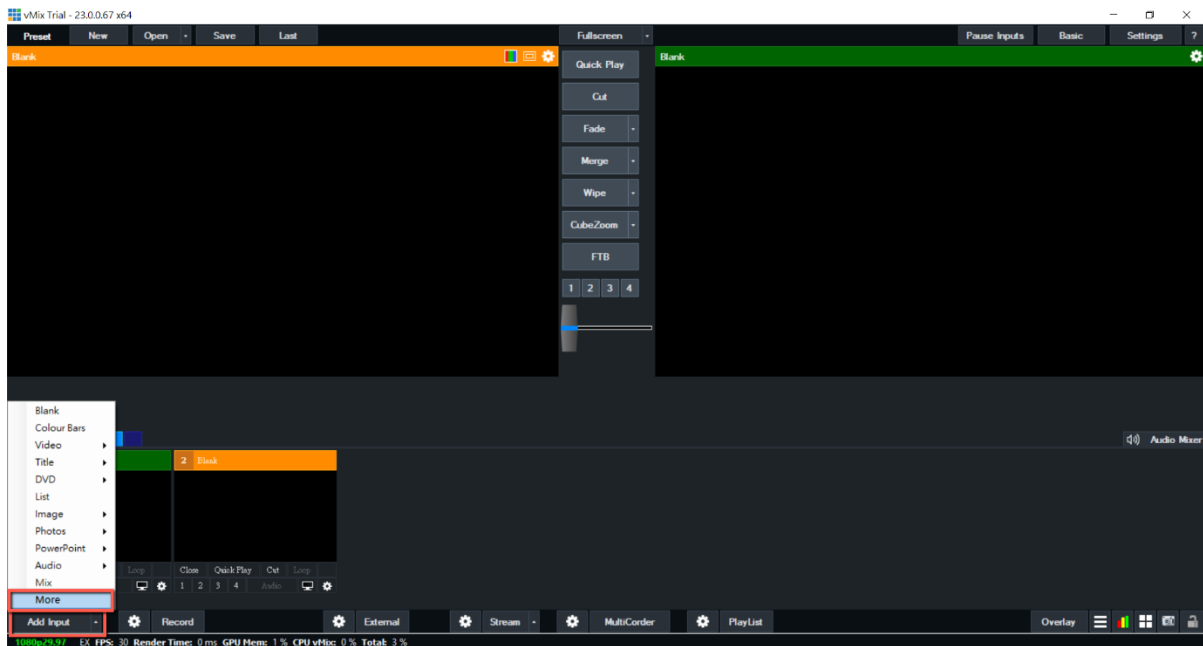

On the Input Select window, click “Stream/SRT” then select “SRT Listener” from the “Stream Type” drop-down list. After that, enter the following into the respective fields.

- Port: 9000 (SRT port number ranges from 1024 to 65535.)

You can leave passphrase empty as it is not supported on the NVS-32.

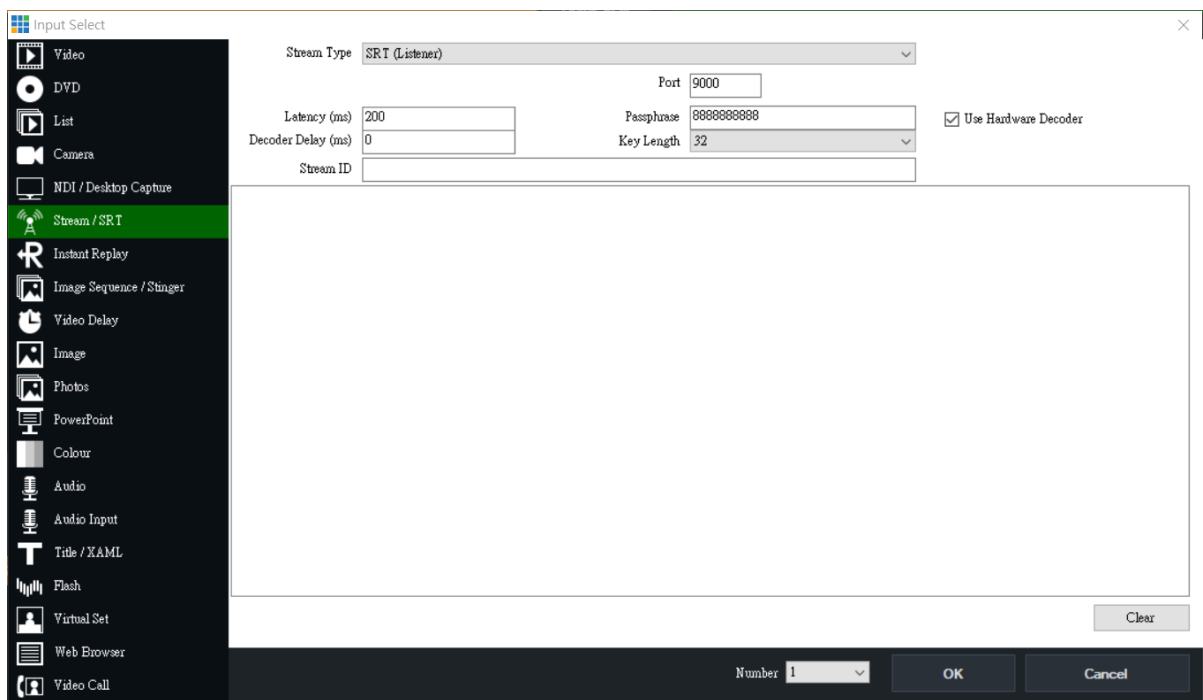

Click the “OK” button to start streaming to vMIX from NVS-32 via SRT.

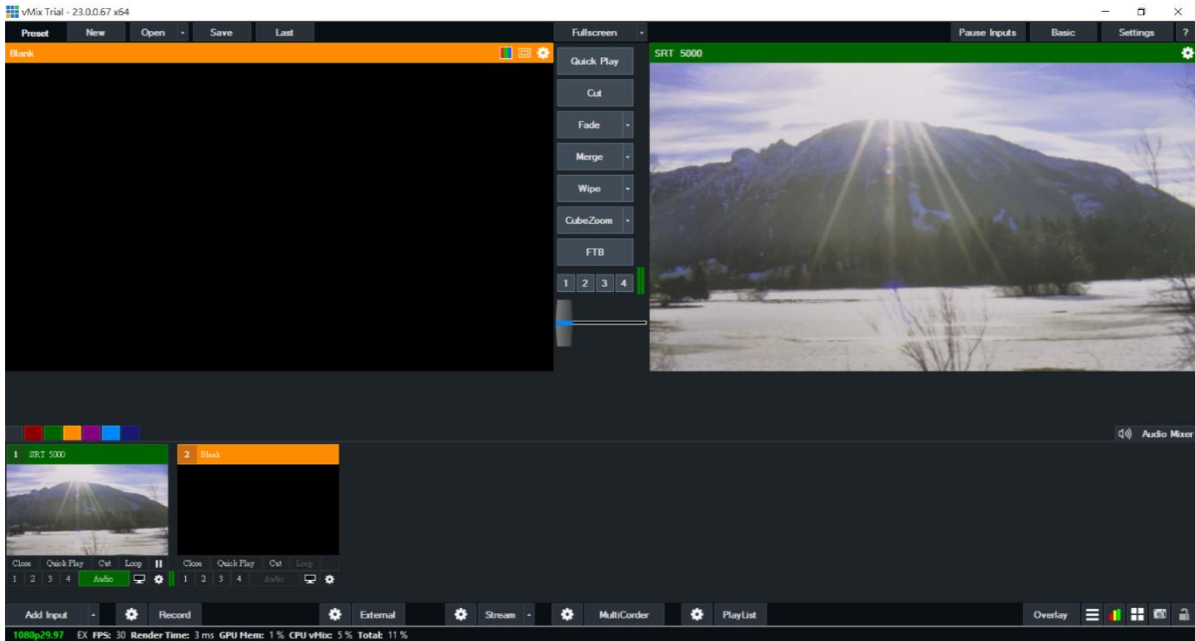

8.4 Panel Buttons

The **START/STOP**, **BITRATE**, **FORMAT** and **MODE** buttons on the front panel of the HS-2600 give the user certain controls of the record and stream functions. In this section, we will cover operations of these four buttons in detail.

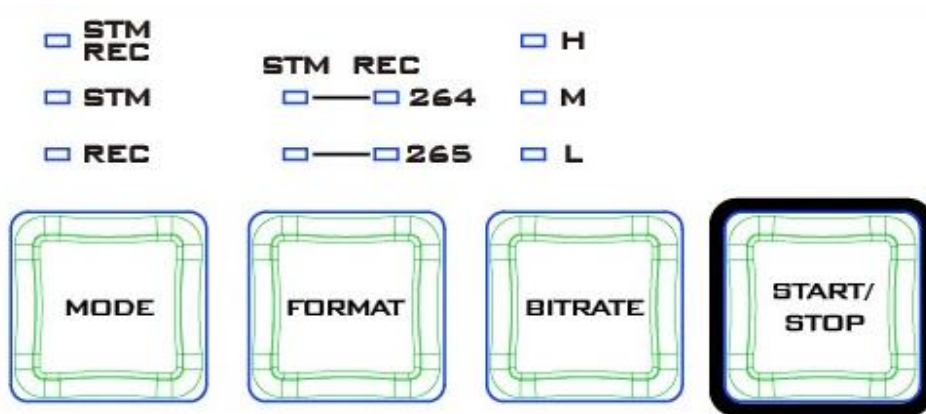

Button and LED Behavior

See the table below for button and LED behavior.

		MODE	FORMAT	BITRATE	START/STOP
LED states before button push	Blinking White	N/A	N/A	N/A	N/A
	Solid White	Push to switch operation mode.	Push to change video compression standard according to the mode selected.	Push to switch between H, M and L.	Push and hold for at least 2 seconds to start device operation.

	Blinking Red	N/A	N/A	N/A	Error; check the Message box for error code.
	Solid Red	Mode change in progress	Video compression standard change in progress	Bitrate change in progress	Push and hold for at least 2 seconds to stop device operation.

MODE Button

Press the **MODE** button to select the device's mode of operation. The available modes are listed as follows:

- **STM+REC:** Stream and record simultaneously
- **STM ONLY:** Stream only
- **REC ONLY:** Record only

STM
 REC
 STM
 REC

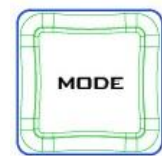

The LED indicator of the selected mode of operation should turn ON.

Please note that when STM+REC is selected, you can only set either one of the stream and record channels to 4K or both channels to HD. Use the RES button to select resolution.

FORMAT Button

STM REC
 — 264
 — 265

Press the **FORMAT** button to change the video compression standard. You can select either H.264 or H.265 for both streaming and recording.

The LED indicators will show you the standard selected.



BITRATE Button

Press the **BITRATE** button to select the bitrate mode for video streaming and recording. The available bitrate modes are listed as follows:

- H: High
- M: Moderate
- L: Low

Note: The default bitrate is M.

The correlated video bitrates of the encoder and the recorder in each mode are summarized in the table below:

Modes	Encoder	Recorder
Low	6 Mbps	20 Mbps
Medium	8 Mbps	30 Mbps
High	10 Mbps	40 Mbps

You can also change the video bitrate using the web user interface, see [Encoder](#) for details.

START/STOP Button

Lastly, after you've configured the operation mode, press and hold for at least 2 seconds to enable/disable live streaming/recording.

8.5 Resetting Login Credentials

If you forget your username and/or password, follow the steps below to reset the web UI's login credentials.

1. Press the stream control buttons in the following order:
Start/Stop → Bitrate → Res → Res → Mode → Mode → Mode
2. The **Mode** button will flash red/white colors for about 5 seconds.
3. The device will start resetting the login credentials.
4. Use admin/admin to log in next time.

Chapter 9. Appendices

Appendix 1 Tally Outputs

The HS-2600 has a D-sub 25 pin female tally output port. These connections provide bi-colour tally information to a number of other Datavideo products, such as the ITC-100 eight channel talkback system and the TLM range of LCD Monitors.

These ports are open collector ports and as such do not provide power to tally light circuits.

Dielectric strength: Max. DC 24V

Current: Max. 50mA

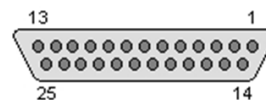

(D-sub 25-Pin Female)

The pin outputs are defined as follows:

Pin No.	Signal name	Input/Output	Signal Description
1	Program 1	Open collector output	Tally output of input video Program 1
2	Program 2	Open collector output	Tally output of input video Program 2
3	Program 3	Open collector output	Tally output of input video Program 3
4	Program 4	Open collector output	Tally output of input video Program 4
5	Program 5	Open collector output	Tally output of input video Program 5
6	Program 6	Open collector output	Tally output of input video Program 6
7	Program 7	Open collector output	Tally output of input video Program 7
8	Program 8	Open collector output	Tally output of input video Program 8
9	Program 9	Open collector output	Tally output of input video Program 9
10	Program 10	Open collector output	Tally output of input video Program 10
11	Program 11	Open collector output	Tally output of input video Program 11
12	Program 12	Open collector output	Tally output of input video Program 12
13	GND	Ground	Ground
14	Preset 1	Open collector output	Tally output of input video Preset 1
15	Preset 2	Open collector output	Tally output of input video Preset 2
16	Preset 3	Open collector output	Tally output of input video Preset 3
17	Preset 4	Open collector output	Tally output of input video Preset 4
18	Preset 5	Open collector output	Tally output of input video Preset 5
19	Preset 6	Open collector output	Tally output of input video Preset 6
20	Preset 7	Open collector output	Tally output of input video Preset 7
21	Preset 8	Open collector output	Tally output of input video Preset 8
22	Preset 9	Open collector output	Tally output of input video Preset 9
23	Preset 10	Open collector output	Tally output of input video Preset 10
24	Preset 11	Open collector output	Tally output of input video Preset 11
25	Preset 12	Open collector output	Tally output of input video Preset 12

Example of tally connections

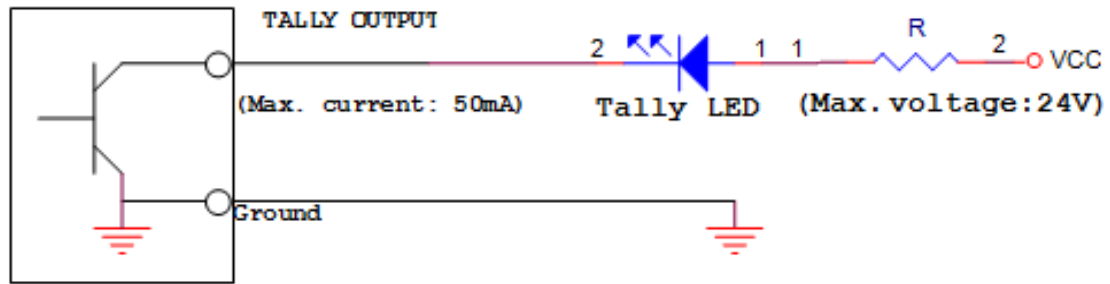

Appendix 2 GPI / GPO Connections

The HS-2600 can control external recorder/playback devices like the HDR-80 and HDR-90 via a simple contact closure GPI / GPO switch.

The GPI interface is a 3.5mm Jack Socket which is situated on the rear panel of the HS-2600. Contact closure between the Outer and Inner contacts on the jack plug will trigger a user selected event. Power is supplied by the HS-2600 and is less than 5V DC.

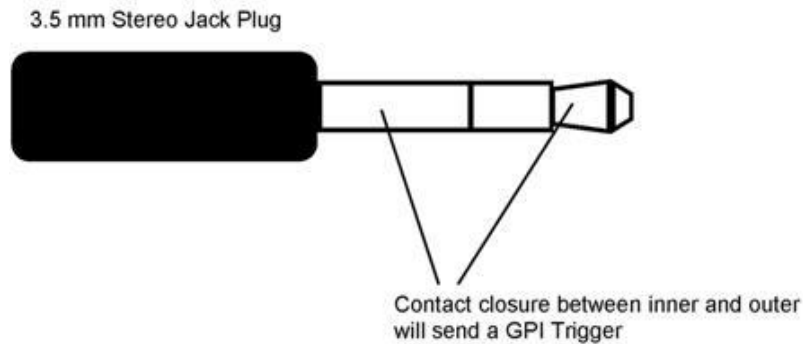

This GPI socket can also be used as a GPO socket to trigger record or playback events with other equipment such as the Datavideo HDR-80 or HDR-90 recorder.

SAFETY FIRST The cabling required needs to be designed specifically to connect the HS-2600 to the chosen record or playback device as they are not all the same. The cabling required can be made by yourself or a competent technician. Please speak with your Dealer or local Datavideo office to get further help and advice.

Appendix 3 RS-232 Serial Port Pinout

The user is allowed to connect a custom keyboard controller to the HS-2600 via RS-232 interface (the user may also enable RS-422 if necessary). The table below provides the RS-232 serial port pinout on the device end (HS-2600). Note that the RS-232 port is a 9 pin D-sub female connector.

Pin No.	Signal
Pin 1	GND
Pin 2	TXD (RS-232)
Pin 3	RXD (RS-232)
Pin 4	GND
Pin 5	GND
Pin 6	GND
Pin 7	TXD (RS-422)
Pin 8	RXD (RS-422)
Pin 9	GND

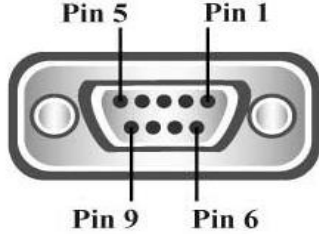













The diagram shows a 9-pin D-sub female connector. The pins are arranged in a 3x3 grid. The top row contains Pin 5 (left) and Pin 1 (right). The middle row contains Pin 9 (left) and Pin 6 (right). The bottom row contains two unlabeled pins. The connector is labeled "RS232 Pinout (9PIN female)".

You may download the RS-232 control protocol from the product page.

Appendix 4 Recommended SD Cards

You should only use Class 10 SD card or above. In this appendix, you will find a list of SD cards recommended by Datavideo.

Recommended SD Cards			
No.	Brand	Model	Pictures
1	Kingston	SDHC I C10 16GB	
2	SANDISK Extreme	SDXC I C10 U3 V30 64GB	
3	SONY	SDXC I C10 U1 64GB	
4	SANDISK Extreme PRO	SDXC I C10 U3 128GB/64GB	 
5	SONY	SDXC I C10 U3 64GB	
6	TOSHIBA	SDHC C10 16GB	

Recommended SD Cards			
No.	Brand	Model	Pictures
7	SANDISK Extreme	SDHC C10 16GB	
8	ADATA Premier Pro	microSDXC I UHS-I U3 Class 10 with SD adapter 64GB/16GB	 
9	SANDISK ULTRA®	SDHC™/SDXC™ UHS-I 128GB	
10	Transcend	300S UHS-I SDHC 64GB/32GB	 

Appendix 5 Firmware Update

Datavideo usually releases new firmware containing new features or reported bug fixes from time to time. Customers can either download the HS-2600 firmware as they wish or contact their local dealer or reseller for assistance.

This section outlines the firmware upgrade process which should take ***approximately 1 hour 20 minutes to complete***.

The existing HS-2600 settings should persist through the *firmware upgrade process, which should not be interrupted once started* as this could result in a non-responsive unit.

Successful firmware upgrade on HS-2600 requires:

- PC or laptop
- USB drive
- Access to the Internet for software download

To update the HS-2600 firmware:

1. Download the latest firmware and the update tool from the path below.
www.datavideo.com → products → Switchers → HS-2600 → Downloads → Latest Firmware
2. Decompress the downloaded files.
3. Insert the USB drive into the PC or laptop and format the drive to FAT or FAT32 system. Save the latest firmware on the drive.
4. Remove the USB drive from the PC or laptop.
5. Insert the USB drive into the **F/W Upgrade** port at the rear of the HS-2600 switcher.
6. Press the **MENU** button on the HS-2600 control panel to open the OSD menu.
7. At the bottom of the **Main Menu**, enter the **SETUP** sub menu.
8. Under the **Software** option, select “**Upgrade**” and press the **ENTER** button to confirm.
9. If you see “**Upgrade**” against a red background, it means the switcher is being updated.
10. When you see red turned to green, it means the firmware upgrade is successful.
11. Reboot the HS-2600 switcher to complete the upgrade.

Appendix 6 Frequently-Asked Questions

This section describes problems that you may encounter while using the HS-2600. If you have any questions, please refer to related sections and follow all suggested solutions. If problem still exists, please contact your distributor or the service center.

No.	Problems	Solutions
1	Grabbed picture is distorted or contains noise.	Successfully grabbed pictures to Still 1 and 2 will be distorted or appear noisy if switched to different video standards.
2	Loaded still picture contains noise.	Still pictures will be distorted or appear noisy if switched to different video standards.
3	What kind of files can be saved on the HS-2600 and is there any limitation?	You can save still pictures, user memory, clips and logos to the HS-2600's memory but the maximum storage space is limited to 1000 frames.
4	One of the FLEX sources is not displayed in the FLEX windows.	The maximum Flex™ output size is 1080p full screen. If exceeded, one Flex source will not be displayed.
5	HS-2600 is unable to save the last settings into its nonvolatile memory.	The Last Memory Auto Save feature automatically saves the last configured settings upon exiting the OSD menu. It takes approximately 10 seconds for the switcher to save the settings so wait for at least 10 seconds before shutting the machine.
6	Why am I seeing black thin lines on PIP images?	These black thin lines are caused by using an image that differs from its original size. To remove these black thin lines, turn the border OFF or use the PIP Crop function to shrink the image until they disappear.

Appendix 7 Dimensions & Weight

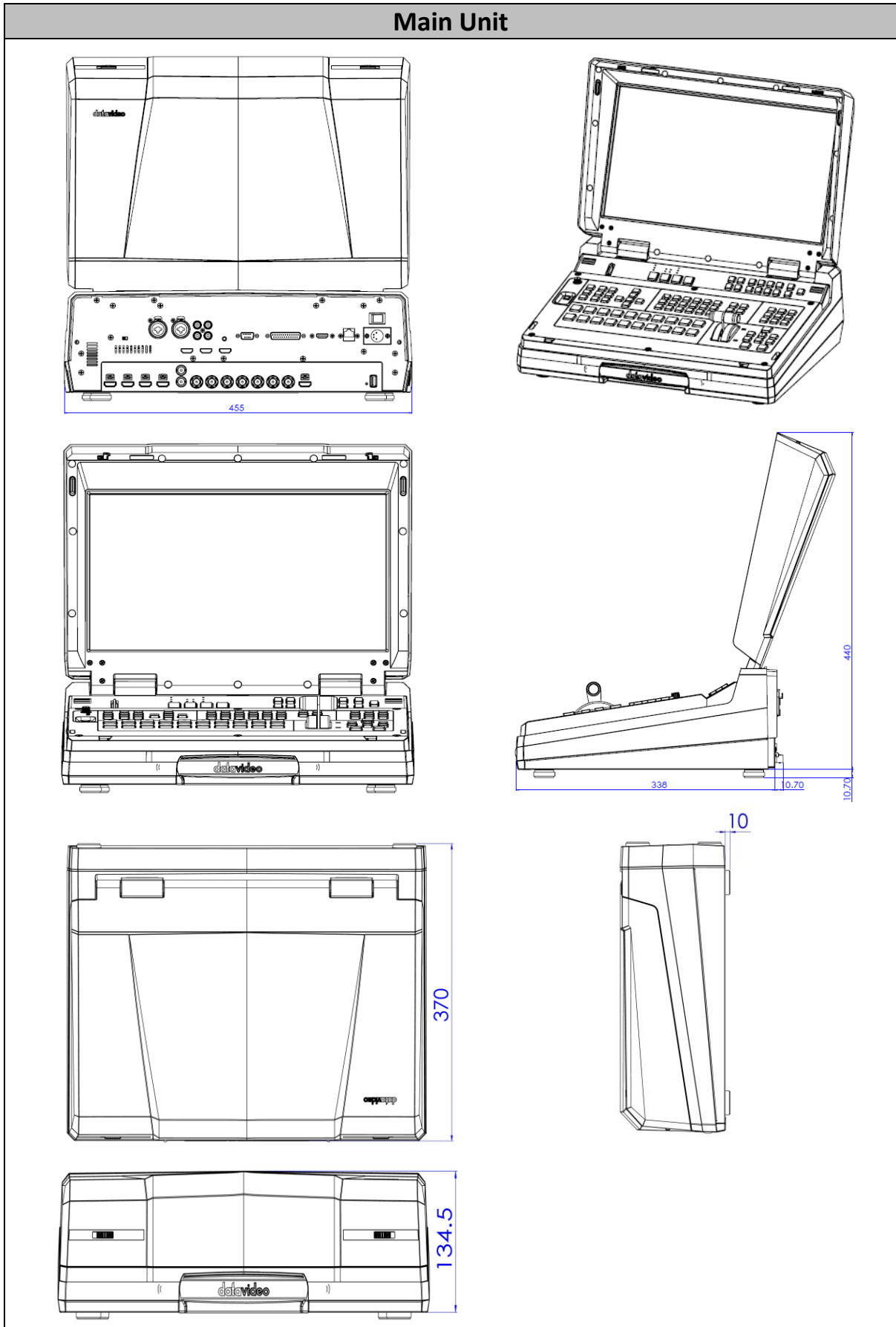

All measurements in millimeters (mm)

Appendix 8 Specifications

Model Name	HS-2600
Product Name	8-Channel HD Portable Video Streaming Studio
Video Standard	HD
Video Format	Output: 1080p 50/ 59.94/ 60Hz 1080i 50/ 59.94/ 60Hz 720p 50/ 59.94/ 60Hz Input: 1080p 50/ 59.94/ 60Hz 1080i 50/ 59.94/ 60Hz 720p 50/ 59.94/ 60Hz
Input Rutable / Crosspoint	All 8, repeatable
Video Input	4 x 3G-SDI 4 x HDMI
Computer Graphical Interface	4 via HDMI
Video Output	3 x 3G-SDI and 1 HDMI 1.4 outputs assignable: <ul style="list-style-type: none"> • Multiview • Program • Preview • Program + DSK • Clean Program • Clean Preview • Input 1 – 8 • Still 1 • Still 2 • Flex Src 1 3 x HDMI 1.4 for PGM only
Analogue Audio Input	2 x XLR/MIC (6.3 mm) Combo Socket 1 x Stereo RCA set (L/R)
Analogue Audio Output	1 x Stereo RCA set (L/R)
Digital Embedded Audio Support	SDI Input/Output 4 Channels HDMI Input/Output 2 Channels
Audio Delay Calibration	up to 16 frames
A+V Switching	Yes
USK	4 Keyers supporting Chromakey & Linear/ Luma Key
DSK	2 x DSK supporting Lumakey & Linear key (Key / Fill)
Picture in Picture	4
Logo Insertion	2

Title Creator	Yes
Built-in Monitor Display	17.3" HD TFT LED backlit, 1920x1080 pix
Streaming	H.264: MAX RES 1080p H.265: MAX RES 1080p
Streaming Audio Encode	AAC 2CH 16bit 48kHz 192kbps
Streaming Protocol	RTSP RTMP SRT
Streaming and Recording Control	Web browser UI for configuration and control socket commands
Recording File System	FAT32, exFAT
Recording File Format	MP4 (H.265 + AAC) or (H.264 + AAC)
Special Features	4 Chroma-Key Virtual Studio 9 stinger transitions and 4 user presets Built-in CG title overlay system Streaming encoder and recorder
Dimensions (LxWxH)	455 x 355 x 134 mm
Weight	8.5 kg, Reinforce Plastic Case
Power	DC 12V, 11A
Operating Temperature	0°C - 40°C [32°F - 104°F]

Service & Support

It is our goal to make owning and using Datavideo products a satisfying experience. Our support staff is available to assist you to set up and operate your system. Contact your local office for specific support requests. Plus, please visit www.datavideo.com to access our FAQ section.

Please visit our website for latest manual update.

www.datavideo.com/product/HS-2600

datavideo
www.datavideo.com



@DatavideoUSA @DatavideoIndia2016
@DatavideoEMEA @Datavideojapan
@DatavideoTaiwan @DatavideoLatam
@DatavideoAsia @DatavideoBrasil



@Datavideo
@Datavideo_EMEA
@Datavideo_Taiwan



@DatavideoUSA
@DVTWDCN



@DatavideoUSA
@DatavideoEurope