

# Liberty

## User Manual



DL-EARCEXT-H2

eARC Audio-Only Extender

# Contents

Introduction .....	2
Overview .....	2
Features .....	2
Package Contents .....	2
Specifications .....	3
Transmission Distance .....	4
Panel Descriptions .....	4
Transmitter .....	4
Receiver .....	5
Installation and Wiring .....	7
Installation .....	7
Wiring .....	8
DIP Switch Settings .....	12
RS232 Pass-Through .....	13

# Introduction

## Overview

This product is an eARC audio-only extender kit. It can transmit eARC/ARC or alternative S/PDIF audio up to 100m/330ft from TV back to centralized AVR. The kit supports full eARC capabilities up to Dolby Atmos. It also supports full eARC function and is backward compatible with 5.1CH ARC. It also features bi-directional IR, RS232, and CEC pass-through between the eARC transmitter and receiver.

## Features

- Supports transmitting eARC/ARC audio up to 100m/330ft over a single Cat 5e/6 or above cable.
- The eARC audio supports article-based audio formats like Dolby Atmos and DTS:X, and also supports lossless audio formats like Dolby TrueHD and DTS HD Master.
- Provides alternative S/PDIF audio return channel, which can be set through a simple 2-pin DIP switch.
- Multiple control methods, including bi-directional IR, RS232 and CEC between transmitter and receiver.
- Powered via Micro USB. Both transmitter and receiver could be powered by 5V USB power.
- Firmware upgradable via RS232 port.

## Package Contents

- 1 x Transmitter
- 1 x Receiver
- 1 x Power Adapter (DC 5V 1A)

- 2 x Micro USB to USB Type-A Cables (L=1m)
- 1 x IR Emitter
- 1 x IR Receiver
- 2 x 3.5mm 3-Pin Phoenix Connector
- 8 x Mounting Brackets (with Screws)

## Specifications

Technical	
Input/Output Port	Transmitter: 1 x HDMI OUT, 1 x UTP OUT, 1 x S/PDIF IN, 1 x IR IN, 1 x IR OUT, 1 x RS232, 1 x Micro USB (for power input) Receiver: 1 x HDMI IN, 1 x UTP IN, 1 x S/PDIF OUT, 1 x IR IN, 1 x IR OUT, 1 x RS232, 1 x Micro USB (for power input)
Audio Format Supported	<b>S/PDIF:</b> Dolby Digital, Dolby Digital Plus, DTS, DTS HD, PCM 2.0 <b>ARC:</b> Dolby Digital, Dolby Digital Plus, DTS, DTS HD, PCM 2.0 <b>eARC:</b> PCM 2.0, PCM 5.1, PCM 7.1, Dolby Digital, Dolby Digital Plus, Dolby TrueHD, Dolby Atmos, DTS, DTS HD, DTS HD Master Audio, DTS:X

General	
Operating Temperature	0°C to 45°C (32°F to 113°F)
Storage Temperature	-20°C to 70°C (-4°F to 158°F)
Humidity	10% to 90%, non-condensing
ESD Protection	Human-body Model: ±8kV (Air-gap discharge)/ ±4kV (Contact discharge)
Power Supply	DC 5V 1A
Power Consumption	3.582W (Max)
Device Dimension (W x H x D)	120mm x 25mm x 70.2mm/ 4.72" x 0.98" x 2.76" each for TX/RX
Product Weight	0.32kg/0.71lb

## Transmission Distance

**Note:** T568B straight-through Category cable is recommended.

Cable Type	Range
Cat 5e/6 or above	100m/330ft
HDMI	Input/Output: 5m/16ft

## Panel Descriptions

### Transmitter

Front Panel

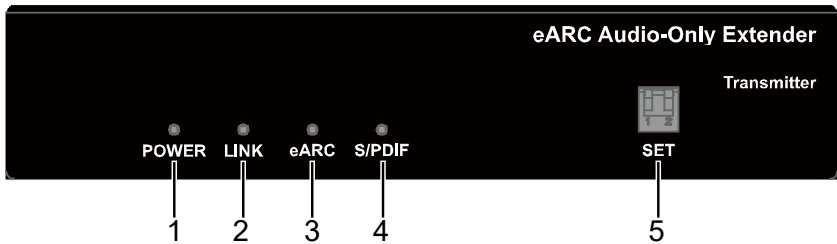

No.	Name	Description
1	POWER LED	<b>On/Off:</b> The device is powered on/off.
2	LINK LED	<b>On:</b> UTP link is normal. <b>Off:</b> No UTP link or link error.
3	eARC LED	<b>On:</b> The eARC audio is being transmitted. <b>Blinking:</b> The ARC audio is being transmitted. <b>Off:</b> No eARC and ARC audio are being transmitted.
4	S/PDIF LED	<b>On:</b> The S/PDIF audio is being transmitted. <b>Off:</b> No S/PDIF audio is being transmitted.
5	SET	For eARC/ARC audio output channel selection. <b>Note:</b> Detail information, please refer to " <a href="#">DIP Switch Settings</a> " section.

## Rear Panel

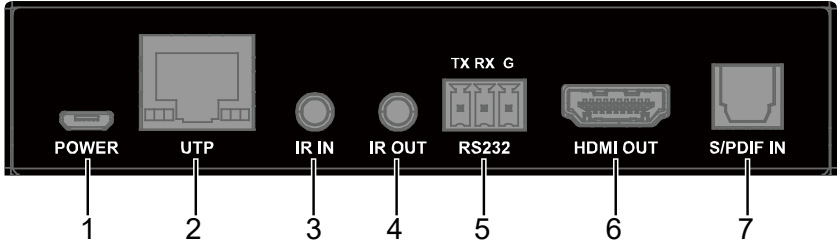

No.	Name	Description
1	POWER	Use the provided Micro USB to USB type-A cable to connect with 5V power source (Such as USB port of display).
2	UTP	Connect to UTP IN port of the receiver.
3	IR IN	Connect to the IR receiver provided.
4	IR OUT	Connect to the IR emitter provided.
5	RS232	Connect to RS232 enabled device for RS232 pass-through or upgrading.
6	HDMI OUT	Connect to a display's eARC/ARC HDMI input port.
7	S/PDIF IN	Connect to a display's Toslink output port.

## Receiver

### Front Panel

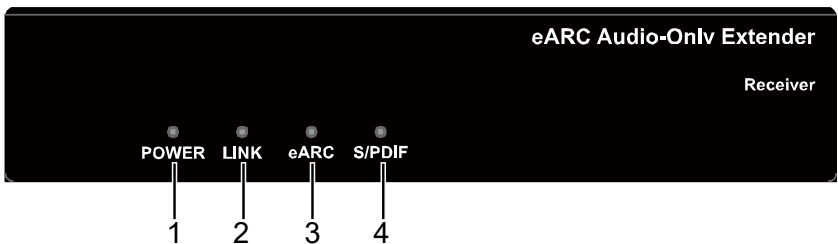

No.	Name	Description
1	POWER LED	<b>On/Off:</b> The device is powered on/off.
2	LINK LED	<b>On:</b> UTP link is normal. <b>Off:</b> No UTP link or link error.

No.	Name	Description
3	eARC LED	<b>On:</b> The eARC audio is being transmitted. <b>Blinking:</b> The ARC audio is being transmitted. <b>Off:</b> No eARC and ARC audio are being transmitted.
4	S/PDIF LED	<b>On:</b> The S/PDIF audio is being transmitted. <b>Off:</b> No S/PDIF audio is being transmitted.

### Rear Panel

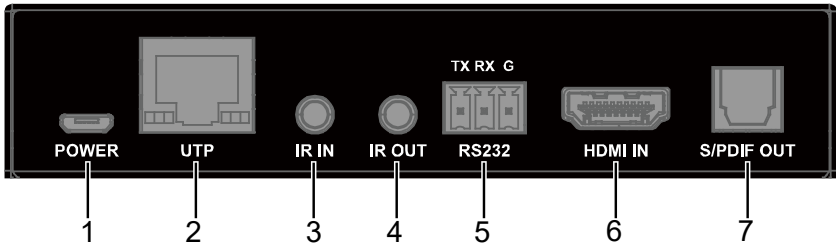

No.	Name	Description
1	POWER	Use the provided Micro USB to USB type-A cable to connect with 5V power source.
2	UTP	Connect to UTP OUT port of the transmitter.
3	IR IN	Connect to the IR receiver provided.
4	IR OUT	Connect to the IR emitter provided.
5	RS232	Connect to RS232 enabled device for RS232 pass-through or upgrading.
6	HDMI IN	Connect to an AV receiver's eARC/ARC HDMI output port.
7	S/PDIF OUT	Connect to an AV receiver's Toslink input port.

# Installation and Wiring

## Installation

### Warnings:

- Before wiring, disconnect the power from the device.
- During wiring, connect and disconnect the cables gently.

### Steps to install the device:

1. Attach the installation bracket to the enclosure using the screws provided in the package separately.
2. The bracket is attached to the enclosure as shown.

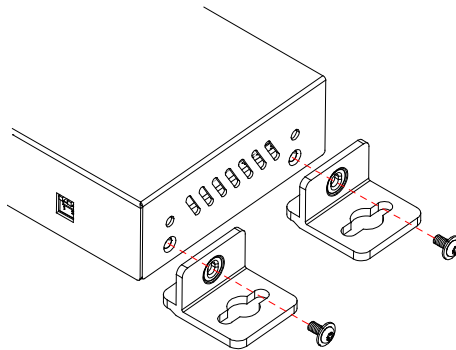

3. Repeat the steps from 1 to 2 for the other side of the unit.
4. Attach the brackets to the surface you want to hold the unit against using the screws (provided by others).
5. Repeat the steps from 1 to 4 to install the receiver.



# Wiring

## Warnings:

- Before wiring, disconnect the power from all devices.
- During wiring, connect and disconnect the cables gently.

**Note:** Ensure the connected display support eARC/ARC function and its CEC function should be set to enable.

The extender supports two channels to output eARC/ARC audio from the connected display.

1. Set the DIP switch of transmitter to eARC/ARC or S/PDIF channel (See [“DIP Switch Settings”](#) section).
2. Connect the receiver’s HDMI IN port to an AV Receiver’s eARC/ARC HDMI output port. Or connect the receiver’s S/PDIF OUT port to an AV Receiver’s Toslink input port.
3. Connect the transmitter’s HDMI OUT port to a display’s eARC/ARC input port. Or connect the transmitter’s S/PDIF IN port to a display’s Toslink output port.
4. Connect UTP OUT port of the transmitter to UTP IN port of the receiver.
5. Using the provided Micro USB to USB Type-A cables to connect the transmitter and receiver to 5V power sources.
6. Power on all attached devices. The return audio signal from HDMI OUT port will be transmitted to HDMI IN port, or the return audio signal from S/PDIF IN port will be transmitted to S/PDIF OUT port (according to the selection in step 1).

## For additional wiring:

- **Bi-directional IR pass-through:** Connect the provided IR receiver to IR IN port of the transmitter/receiver, and connect the provided IR emitter to IR OUT port of the receiver/transmitter. You can control the display at receiver side or control the AV receiver at transmitter side.
- **Bi-directional RS232 pass-through:** Connect RS232 enabled devices

such as PC to RS232 ports of the transmitter and receiver. (See "[RS232 Pass-Through](#)" section)

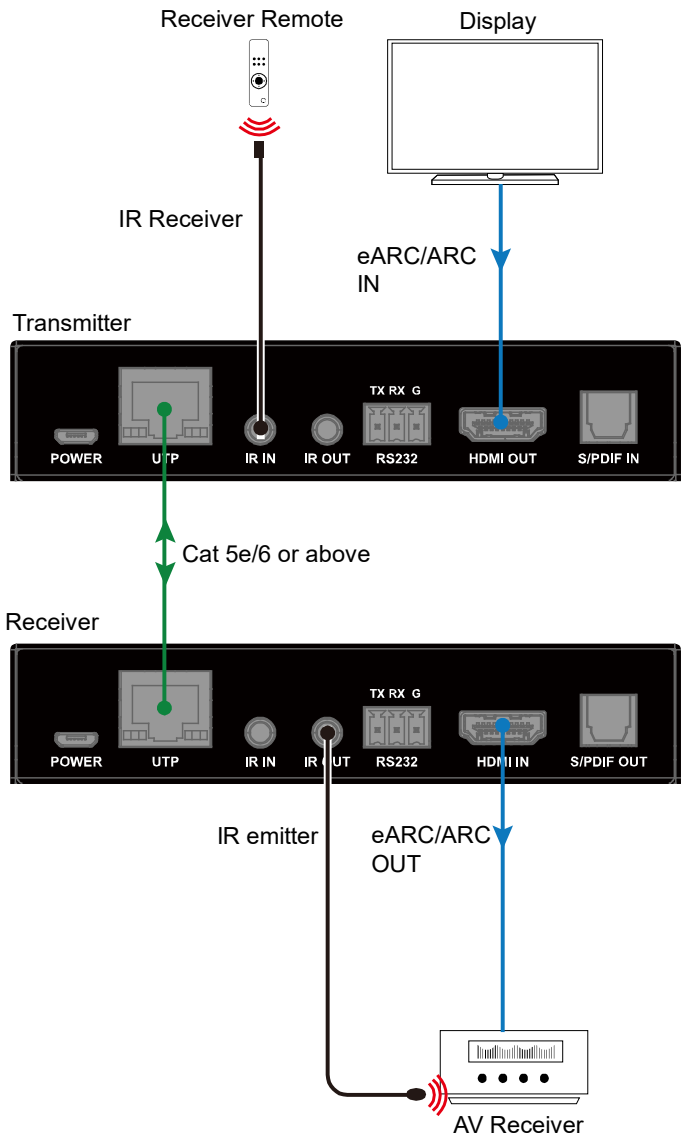

Figure 1 eARC / ARC Channel

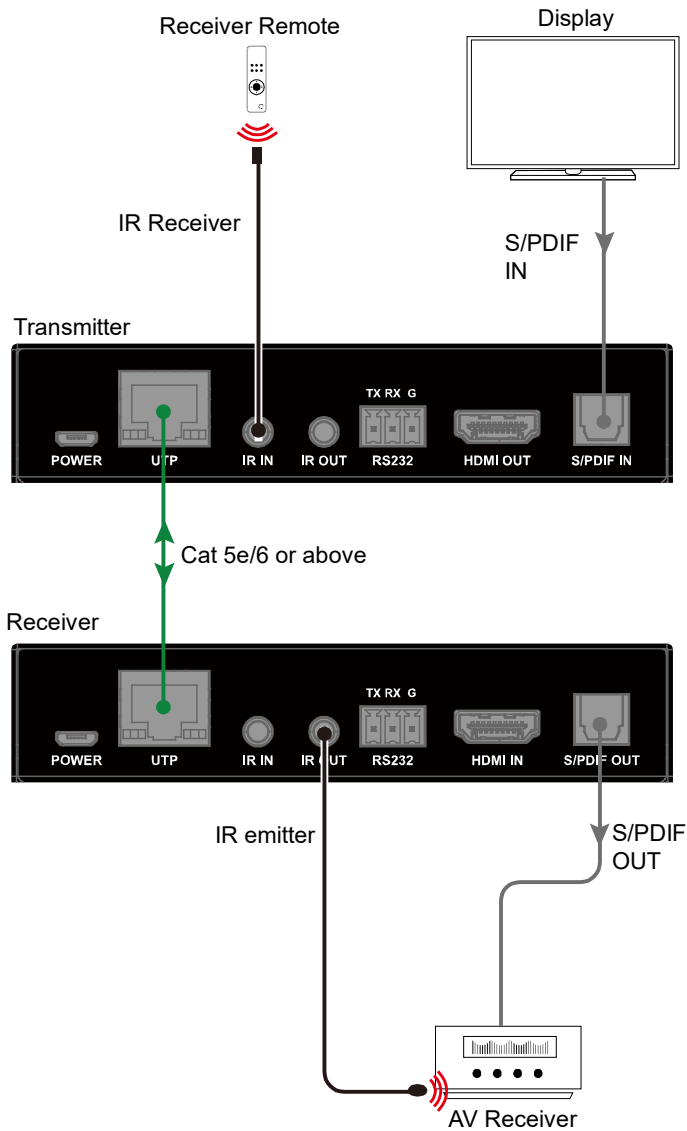

Figure 2 S/PDIF Channel

# DIP Switch Settings

Before powering on the kit, using DIP Switch on front panel of the transmitter to select the channel to output the eARC/ARC audio.



Please refer to the following table to set:

Transmitter		Function
1	2	
Up	-	eARC/ARC Channel (default)
Down	-	S/PDIF Channel

“-“ indicates the position of this DIP switch has no influence on the function.

## Note:

- 1) When select output eARC audio, audio format supported is as follows:
  - Up to 8ch L-PCM of 24 bit, 192kHz audio;
  - Support HBR audio formats, such as Dolby True-HD, Dolby Atmos and DTS-X.
- 2) When output ARC audio, audio format supported is as follows:
  - Supports 5.1ch compressed audio, such as Dolby Digital, DTS 5.1, and Dolby Digital Plus;
  - Supports 2.0ch uncompressed PCM audio.
- 3) When output the return audio through S/PDIF port, audio format supported is as follows:
  - Supports 5.1ch compressed audio, such as Dolby Digital, DTS 5.1, and Dolby Digital Plus;
  - Supports 2.0ch uncompressed PCM audio.

# RS232 Pass-Through

RS232 ports can be used for bi-directional RS232 signal pass-through between the transmitter and receiver.

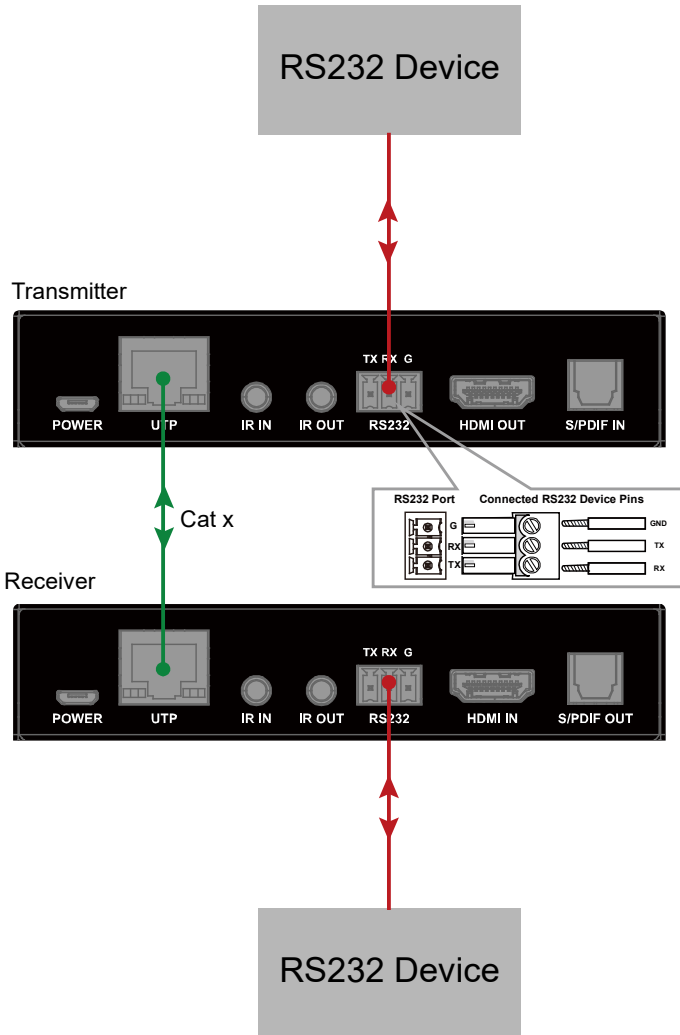

Thank you for your purchase.

For Technical Support please call our toll free number at  
800-530-8998 or email us at [supportlibav@libav.com](mailto:supportlibav@libav.com)

[www.libav.com](http://www.libav.com)

The logo for Liberty, featuring the word "Liberty" in a bold, black, sans-serif font. The letter "i" is stylized with a small orange square above its dot.

1490 Garden of the Gods Suite F  
Colorado Springs, Colorado  
80907 USA  
Phone: 719-260-0061  
Fax: 719-260-0075  
Toll-Free: 800-530-8998