

L Series and C Series FIR-Drive Power Amplifiers



en | Installation manual



DYNACORD

Table of contents

1	Safety	5
1.1	Safety messages explained	5
1.2	Important safety instructions	5
1.3	Safety precautions	7
1.4	FCC	8
1.5	Notices	8
2	About this manual	9
2.1	Manual purpose	9
2.2	Digital document	9
2.3	Intended audience	9
2.4	Short Information	9
3	System overview	11
3.1	Application area	11
3.2	Features	11
3.3	Unpacking and inspection	11
3.4	Scope of delivery	11
4	Planning information	13
5	Installation	14
5.1	Operating voltage	14
5.2	Power	14
5.2.1	L Series	14
5.2.2	C Series	14
5.3	Mounting	15
5.4	Ventilation	15
6	Controls, indicators and connections	17
6.1	L Series amplifier	17
6.2	C Series amplifier	18
6.3	Fan cooling	18
6.4	Groundlift	19
6.5	USB B connector	19
6.6	Power remote	19
6.7	Power on delay	19
6.8	GPI/GPO	19
6.9	Power outputs	20
6.9.1	L Series amplifier	20
6.9.2	C Series amplifier	21
6.10	Audio input cabling	22
6.10.1	Audio input cabling for XLR-type connectors	22
6.10.2	Audio input cabling for Euroblock-type connectors	23
7	Power amplifier menu navigation	24
7.1	Amplifier and DSP control	24
7.2	DSP control menu	24
7.3	Factory presets	26
8	Technical data	29
8.1	C Series direct drive load capability	34
8.2	Mains operation & resulting temperature	35

8.3	Block diagrams	38
8.4	Dimensions	40

1 Safety

1.1 Safety messages explained

Four types of signs can be used in this manual. The type is closely related to the effect that may be caused if it is not observed. These signs - from least severe effect to most severe effect - are:



Notice!

Containing additional information. Usually, not observing a 'notice' does not result in damage to the equipment or personal injuries.



Caution!

The equipment or the property can be damaged, or persons can be lightly injured if the alert is not observed.



Warning!



The equipment or the property can be seriously damaged, or persons can be severely injured if the alert is not observed.



Danger!

Not observing the alert can lead to severe injuries or death.

1.2 Important safety instructions

	CAUTION RISK OF ELECTRIC SHOCK DO NOT OPEN	
<p>WARNING: TO REDUCE THE RISK OF FIRE OR ELECTRIC SHOCK, DO NOT EXPOSE THIS APPLIANCE TO RAIN OR MOISTURE.</p> <p>AVIS: RISQUÉ DE CHOC ELECTRIQUE - NE PAS OUVRIR</p>		
<p>CAUTION: TO REDUCE THE RISK OF ELECTRIC SHOCK, GROUNDING OF THE CENTRE PIN OF THIS PLUG MUST BE MAINTAINED.</p> <p>ATTENTION: POUR RÉDUIRE LE RISQUE DE CHOC ÉLECTRIQUE LA FICHE CENTRALE DE LA PRISE DOIT ÊTRE BRANCHÉE POUR MAINTENIR LA MISE À LA TERRE.</p>		



Danger!

The lightning symbol inside a triangle notifies the user of high-voltage, uninsulated lines and contacts inside the devices that could result in fatal electrocution if touched.



Warning!

An exclamation mark inside a triangle refers the user to important operating and service instructions in the documentation for the equipment.

1. Read these safety notes.
2. Keep these safety notes in a safe place.
3. Heed all warnings.
4. Observe all instructions.

5. Do not operate the device in close proximity to water.
6. Use only a dry cloth to clean the unit.
7. Do not cover any ventilation slots. Always refer to the manufacturer's instructions when installing the device.
8. Do not install the device close to heaters, ovens, or other heat sources.
9. Note: The device must only be operated via the mains power supply with a safety ground connector. Do not disable the safety ground connection function of the supplied power cable. If the plug of the supplied cable does not fit your mains socket, please contact your electrician.
10. Ensure that it is not possible to stand on the mains cable. Take precautions to ensure the mains cable cannot become crushed, particularly near the device connector and mains plug.
11. Only use accessories/extensions for the device that have been approved by the manufacturer.
12. Unplug the device if there is risk of lightning strike or in the event of long periods of inactivity. However, this does not apply if the device is to be used as part of an evacuation system!
13. Have all service work and repairs performed by a trained customer service technician only. Service work must be carried out immediately following any damage such as damage to the mains cable or plug, if fluid or any object enters the device, if the device has been used in rain or become wet, or if the device has been dropped or no longer works correctly.
14. Please ensure that no dripping water or spray can penetrate the inside of the device. Do not place any objects filled with fluids, such as vases or drinking vessels, on top of the device.
15. To ensure the device is completely free of voltage, unplug the device from the power supply.
16. When installing the device, ensure that the plug is freely accessible.
17. Do not place any sources of open flame, such as lit candles, on top of the device.
18. This PROTECTION CLASS I device must be connected to a MAINS socket with a safety ground connection.

**Caution!**

Use only manufacturer-approved carts, stands, brackets, or tables that you acquired together with the device. When using carts to move the device, make sure the transported equipment and the cart itself cannot tip over or cause injury or material damage.

IMPORTANT SERVICE INFORMATION**Caution!**

This service information is for use by qualified service personnel only. To avoid the risk of electric shock, do not perform any maintenance work that is not described in the operating instructions unless you are qualified to do so. Have all service work and repairs performed by a trained customer service technician.

1. Repair work on the device must comply with the safety standards specified in EN 60065 (VDE 0860).
2. A mains isolating transformer must be used during any work for which the opened device is connected to and operated with mains voltage.

3. The device must be free of any voltage before performing any alterations with upgrade sets, switching the mains voltage, or performing any other modifications.
4. The minimum distance between voltage-carrying parts and metal parts that can be touched (such as the metal housing) or between mains poles is 3 mm, and must be observed at all times.
5. The minimum distance between voltage-carrying parts and circuit parts that are not connected to the mains (secondary) is 6 mm, and must be observed at all times.
6. Special components that are marked with the safety symbol in the circuit diagram (note) must only be replaced with original parts.
7. Unauthorized changes to the circuitry are prohibited.
8. The protective measures issued by the relevant trade organizations and applicable at the place of repair must be observed. This includes the properties and configuration of the workplace.
9. Observe the guidelines with respect to handling MOS components.

**Danger!**

SAFETY COMPONENT (MUST BE REPLACED BY ORIGINAL PART)

1.3**Safety precautions****Speaker system damage and protection of human beings**

Power amps provide extremely high power output that might be dangerous for human beings as well as for the connected speaker systems. High output voltages can damage or even destroy the connected speaker systems, especially, when the amplifier is operated in bridged mode. Prior to connecting any loudspeakers, make sure to check the speaker system's specifications for continuous and peak power handling capacities. Even if amplification has been reduced through lowering the input level controls on the amplifier's front panel, it is still possible to achieve full power output with a sufficiently high input signal.

**Danger!**

Danger at the loudspeaker/power outputs

Power amplifiers are capable of producing dangerously high voltage output that is present at the output connectors.

To protect yourself from electric shock, do not touch any blank speaker cables during operation of the power amp.

**Danger!**

The terminals marked with a lightning bolt are hazardous live and the external wiring connected to these terminals requires installation by an instructed person or the use of ready-made leads of cords.

**Danger!**

In case of using the amplifier with speakers including a primary tapped transformer, it is possible that during operation shock hazard voltages may be present at the taps of the transformer.

Therefore, the taps have to be insulated sufficiently in accordance with applicable safety regulations.

1.4 FCC

IMPORTANT: Do not modify this unit! Changes or modifications not expressly approved by the manufacturer could void the user's authority, granted by the FCC, to operate the equipment.



Notice!

This equipment has been tested and found to comply with the limits for a Class B digital device, pursuant to Part 15 of the FCC Rules. These limits are designed to provide reasonable protection against harmful interference in a residential installation. This equipment generates, uses and can radiate radio frequency energy and, if not installed and used in accordance with the instructions, may cause harmful interference to radio communications. However, there is no guarantee interference will not occur in a particular installation.

If this equipment does cause harmful interference to radio or television reception or receive audible interference from radio, television or communications equipment, which can be determined by turning the equipment off and on. The user is encouraged to try to correct the interference by one or more of the following measures:

- Reorient or relocate the receiving antenna.
- Increase the separation between the equipment and receiver.
- Connect the equipment into an outlet on a circuit different from that to which the receiver is connected.
- Consult the dealer or an experienced radio/TV/communications equipment technician.

1.5

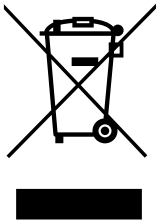

Notices

Old electrical and electronic appliances

Electrical or electronic devices that are no longer serviceable must be collected separately and sent for environmentally compatible recycling (in accordance with the European Waste Electrical and Electronic Equipment Directive).

To dispose of old electrical or electronic devices, you should use the return and collection systems put in place in the country concerned.

Copyright and disclaimer

All rights reserved. No part of this document may be reproduced or transmitted in any form by any means, electronic, mechanical, photocopying, recording, or otherwise, without the prior written permission of the publisher. For information on getting permission for reprints and excerpts, contact Dynacord.

The content and illustrations are subject to change without prior notice.

2 About this manual

2.1 Manual purpose

The purpose of this manual is to provide information required for installing, configuring, operating and maintaining the L Series FIR-Drive Power Amplifier and C Series FIR-Drive Power Amplifier hardware products.

Read through this manual to familiarize yourself with the safety information, features, and applications before you use these products.

2.2 Digital document

This manual is available as a digital document in the Adobe Portable Document Format (PDF).

You can find information about Dynacord products on the product related information at www.dynacord.com.

2.3 Intended audience

This manual is intended for installers, operators, and users of L/C series powered amplifier systems.

2.4 Short Information

The following table lists products in a family, with CTN (Commercial Type Number) and identifying product name DESCRIPTION.

CTN	Description
L Series	
L1300FD-AU	DSP power amplifier 2x650W AU
L1300FD-CN	DSP power amplifier 2x650W CN
L1300FD-EU	DSP power amplifier 2x650W EU
L1300FD-JP	DSP power amplifier 2x650W JP
L1300FD-UK	DSP power amplifier 2x650W UK
L1300FD-US	DSP power amplifier 2x650W US
L1800FD-AU	DSP power amplifier 2x950W AU
L1800FD-CN	DSP power amplifier 2x950W CN
L1800FD-EU	DSP power amplifier 2x950W EU
L1800FD-JP	DSP power amplifier 2x950W JP
L1800FD-UK	DSP power amplifier 2x950W UK
L1800FD-US	DSP power amplifier 2x950W US
L2800FD-AU	DSP power amplifier 2x1400W AU
L2800FD-CN	DSP power amplifier 2x1400W CN
L2800FD-EU	DSP power amplifier 2x1400W EU
L2800FD-JP	DSP power amplifier 2x1400W JP

CTN	Description
L2800FD-UK	DSP power amplifier 2x1400W UK
L2800FD-US	DSP power amplifier 2x1400W US
L3600FD-AU	DSP power amplifier 2x1800W AU
L3600FD-CN	DSP power amplifier 2x1800W CN
L3600FD-EU	DSP power amplifier 2x1800W EU
L3600FD-JP	DSP power amplifier 2x1800W JP
L3600FD-UK	DSP power amplifier 2x1800W UK
L3600FD-US	DSP power amplifier 2x1800W US
C Series	
C1300FDi-AU	DSP power amplifier 2x650W, install AU
C1300FDi-CN	DSP power amplifier 2x650W, install CN
C1300FDi-EU	DSP power amplifier 2x650W, install EU
C1300FDi-JP	DSP power amplifier 2x650W, install JP
C1300FDi-UK	DSP power amplifier 2x650W, install UK
C1300FDi-US	DSP power amplifier 2x650W, install US
C1800FDi-AU	DSP power amplifier 2x950W, install AU
C1800FDi-CN	DSP power amplifier 2x950W, install CN
C1800FDi-EU	DSP power amplifier 2x950W, install EU
C1800FDi-JP	DSP power amplifier 2x950W, install JP
C1800FDi-UK	DSP power amplifier 2x950W, install UK
C1800FDi-US	DSP power amplifier 2x950W, install US
C2800FDi-AU	DSP power amplifier 2x1400W, install AU
C2800FDi-CN	DSP power amplifier 2x1400W, install CN
C2800FDi-EU	DSP power amplifier 2x1400W, install EU
C2800FDi-JP	DSP power amplifier 2x1400W, install JP
C2800FDi-UK	DSP power amplifier 2x1400W, install UK
C2800FDi-US	DSP power amplifier 2x1400W, install US
C3600FDi-AU	DSP power amplifier 2x1800W, install AU
C3600FDi-CN	DSP power amplifier 2x1800W, install CN
C3600FDi-EU	DSP power amplifier 2x1800W, install EU
C3600FDi-JP	DSP power amplifier 2x1800W, install JP
C3600FDi-UK	DSP power amplifier 2x1800W, install UK
C3600FDi-US	DSP power amplifier 2x1800W, install US

3 System overview

3.1 Application area

The L Series and C Series power amplifier are designed to power professional loudspeaker system in live and fix installed audio applications such as concerts, clubs, sports venues, HOWs and many other applications.

3.2 Features

L Series

- Live performance DSP amplifier
- Fully integrated professional speaker processing with FIR Drive technology
- Market leading acoustic performance and rock solid reliability
- True 2 ohm stability
- Intuitive system control software, makes setup and control easy

C Series

- Installation DSP amplifier, Euroblock connectors
- Fully integrated professional speaker processing with FIR Drive technology
- Market leading acoustic performance and rock solid reliability
- Low Z and 70/100V operation and power saving standby mode
- Intuitive system control software, makes setup and control easy

3.3 Unpacking and inspection

Carefully open the packaging and take out the power amplifier. Inspect the power amp's enclosure for damages that might have happened during transportation. Each amplifier is examined and tested in detail before leaving the manufacturing site to ensure that it arrives in perfect condition at your place. Please inform the transport company immediately, if the power amplifier shows any damage. Being the addressee, you are the only person who can claim damages in transit. Keep the cardboard box and all packaging materials for inspection by the transport company.

Keeping the cardboard box including all packing materials is also recommended, if the power amplifier shows no external damages.



Caution!

Do not ship the power amp in any other but its original packaging.

When shipping the power amp, make sure to always use its original box and packaging materials. Packing the power amplifier like it was packed by the manufacturer guarantees optimum protection from transport damage.

3.4 Scope of delivery

Quantity	Component
1	DSP amplifier
1	Mains cord
1	USB cable

Quantity	Component
1	Installation manual
1	Safety instruction card

Table 3.1: L Series

Quantity	Component
1	DSP amplifier
1	Mains cord
1	USB cable
1	Euroblock GPIO connector 6 pole
1	Euroblock output connector 4 pole
2	Euroblock input connectors 3 pole
1	Power remote connector 2 pole
1	Installation manual
1	Safety instruction card

Table 3.2: C Series

Keep the original invoice that states the purchase/delivery date in a safe place.

4 Planning information

Ensure the following:

- You make use of manufacturer specified installation materials.
- No liquids can spill into or on the products.
- Installation is in a clean environment free of dust.
- The ventilation airflow of the 19" units is not obstructed.
- There is a mains power outlet of sufficient rating close to the intended location of the products.
- Sufficient free space and access at the rear of the 19" units for connectors and wiring.

To find current user documentation, firmware, or software visit our product related information at www.dynacord.com.

5 Installation

5.1 Operating voltage

The power amplifier receives its power supply via the MAINS IN connector. Only the provided power cord may be used. During installation, always separate the power amplifier from the mains. Connect the power amplifier only to a mains network, which corresponds to the requirements indicated on the type plate.

5.2 Power

The L Series power button is located on the front of the amplifier panel. The C Series power switch is located on the rear of the amplifier panel.

5.2.1 L Series

The Power button on the front panel separates the power amp from the mains. Pressing the Power button turns on the power amp. A soft start circuit compensates mains inrush current peaks and thus prevents triggering AC mains fuse when switching on the amplifier. Speaker system switch-on is delayed by approximately two seconds via output relays, effectively suppressing any possible power-on noise, which otherwise might be heard through the loudspeakers.

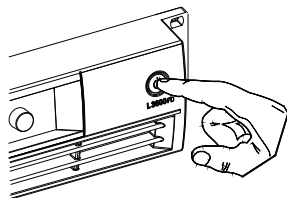

Figure 5.1: Power button on the front panel (L Series)

5.2.2 C Series

C Series

The Power/Standby switch on the rear panel is used to turn on the power to the amplifier or put the amplifier into standby mode. To separate the amplifier from the mains it is required to disconnect the mains power connection. A soft start circuit compensates mains inrush current peaks and thus prevents the automatic cutout of the mains from reacting when switching on the power amplifier. Speaker system switch-on is delayed by approximately two seconds via output relays, effectively suppressing any possible power-on noise, which otherwise might be heard through the loudspeakers. PROTECT-LED lights up and fans are at high speed during this delay. This indicates all protections are working fine.

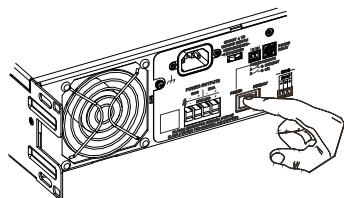

Figure 5.2: Mains switch on the rear panel (C Series)

5.3 Mounting

L Series and C Series amplifiers have been designed for installation in a conventional 19-inch rack case. Attach the power amp with its frontal rack mount ears using four screws and washers as shown in the illustration.

Additionally securing the amplifier at the rear becomes necessary, if the rack case in which the power amplifier has been installed will be transported. Failure to do so may result in damage to the power amplifier as well as to the rack case. Attach the power amp as shown in the illustration using four case nuts and screws. Brackets for securing the power amplifier are available as accessories.

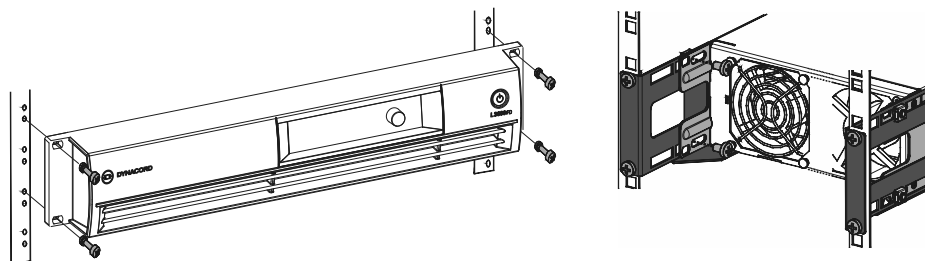

Figure 5.3: Mounting powered an amplifier in a rack, front (left) and rear (right) showing optional RMK-15

5.4 Ventilation

As with all Dynacord power amps with fan cooling, the airflow direction is front-to-rear, obviously because there is more cold air outside of the rack case than inside. The power amplifier remains cooler and dissipating the developing waste heat in a specific direction gets easier. In general, setting up or mounting the power amplifier has to be done in a way that fresh air can enter unhindered at the front and exhausted air can exit at the rear. When installing the power amp in a case or rack system, attention should be paid to these details to provide sufficient ventilation. Allow for an air duct of at least 60 mm x 330 mm between the rear panel of the power amplifier and the inner wall of the cabinet/rack case. Make sure that the duct reaches up to the cabinets or the rack case's top ventilation louvers. Leave room of at least 100 mm above the cabinet/rack case for ventilation. Since temperatures inside of the cabinet/rack case can easily rise up to 40 °C during operation of the power amp, it is mandatory to bear in mind the maximum allowable ambient temperature for all other appliances installed in the same cabinet/rack case.

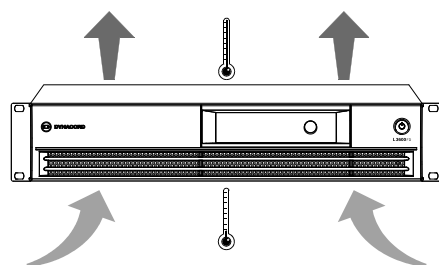

Figure 5.4: Power amplifier ventilation

**Caution!**

Blocking/closing the power amp's ventilation louvers is not permissible. Without sufficient cooling/ventilation, the power amplifier may automatically enter protect mode. Keep ventilation louvers free from dust to ensure unhindered airflow.

**Notice!**

Do not use the power amplifier near heat sources, like heater blowers, stoves, or any other heat radiating devices.

**Notice!**

Do not use Dynacord power amplifiers in an environment where temperatures are below 0°C or exceed +40°C.

For fixed amplifier installations in a device control room that incorporate a central air-cooling system or air conditioners, calculating the maximum heat emission may be necessary.

See also

- *Mains operation & resulting temperature, page 35*

6 Controls, indicators and connections

6.1 L Series amplifier

Front view

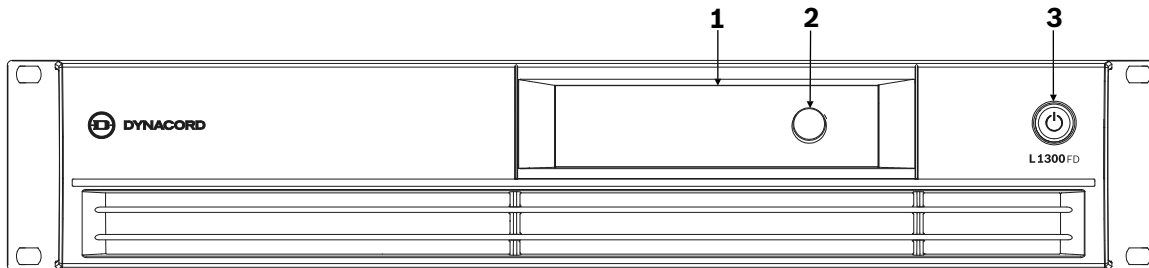

1. LCD - LCD control and monitoring interface.
2. Encoder knob - Scroll through the DSP menu and select the available choices. Push the encoder knob to enter the DSP menu.
3. POWER - AC button for turning the power ON or OFF. The LCD screen lights up when the power is turned on.

Rear view

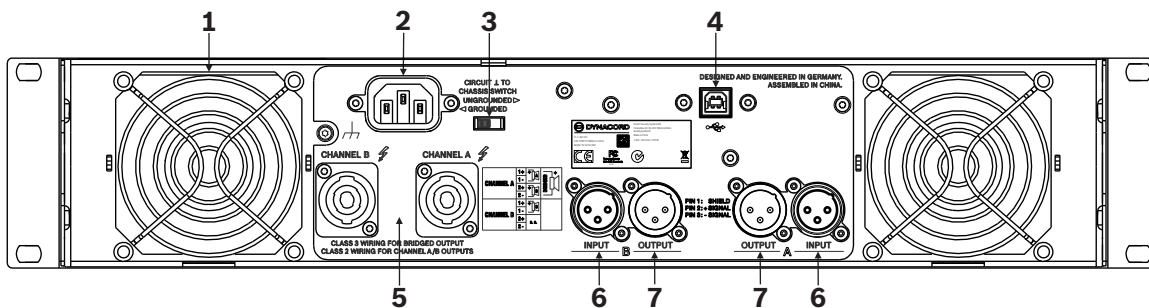

1. FAN - Exhaust air vent for amplifier cooling. Do not obstruct!
2. MAINS IN - AC mains input socket.
3. Groundlift switch (CIRCUIT \perp TO CHASSIS SWITCH) - Switch allows eliminating hum noise loops.
4. USB type B connector.
5. Power amp outputs Speakon (CHANNEL A, CHANNEL B)
6. Audio inputs (INPUT A, INPUT B) directly linked to the outputs.
7. Audio outputs (OUTPUT A, OUTPUT B) directly linked to the inputs.

6.2 C Series amplifier

Front view

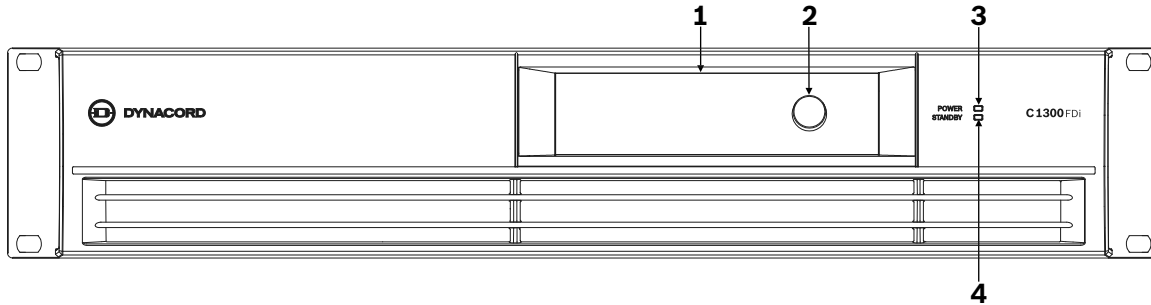

1. LCD - LCD control and monitoring interface.
2. Encoder knob - Scroll through the DSP menu and select the available choices. Push the encoder knob to enter the DSP menu.
3. POWER - Power on/off indicator.
4. STANDBY - standby indicator.

Rear view

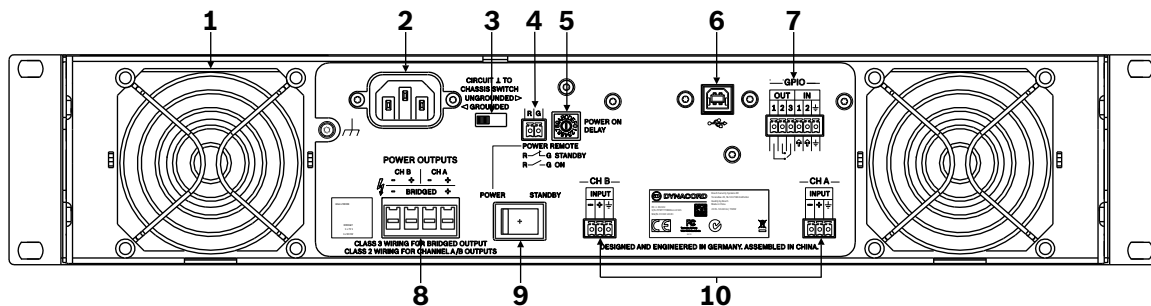

1. FAN - Exhaust air vent for amplifier cooling. Do not obstruct!
2. MAINS IN - AC mains input socket.
3. Groundlift switch (CIRCUIT \perp TO CHASSIS SWITCH) - Switch allows eliminating hum noise loops.
4. POWER REMOTE connector
5. POWER ON DELAY - power on delay selection switch.
6. USB type B connector.
7. GPI/GPO
8. POWER OUTPUTS
9. POWER/STANDBY switch
10. INPUT - audio inputs for channels A or B (CH A, CH B).

6.3 Fan cooling

The power amplifier has two fans. The fans are switched in three performance-optimized levels, for example they are not running permanently but the speed of the fans is controlled depending on the temperature. That in return ensures very silent operation during idle state. The temperatures of the power amp's channels are supervised and monitored individually.

6.4 Groundlift

CIRCUIT ↓ TO
CHASSIS SWITCH
UNGROUND ►
◄ GROUNDED



The ground lift switch allows eliminating hum noise loops. When operating the power amplifier together with other equipment in a rack case, setting the switch to the GROUNDED position is recommended. Set the switch to UNGROUNDED, when the power amplifier is operated together with appliances with differing ground potentials.

6.5 USB B connector

The USB B connector is used for remote control configuration and firmware updates. With the included USB AB cable you can connect the amplifier directly to a PC. To connect multiple amplifiers use an external USB-hub or range extender.

For firmware updates, amplifier control software, and product related information visit our website: www.dynacord.com/software.

6.6 Power remote

POWER REMOTE (standby mode) provides a simple way to remotely power-on/off the power amplifier. Leaving the pins of POWER REMOTE socket open the appliance power is switched on. When connecting the pins the appliance enters standby mode.

6.7 Power on delay

The ON DELAY switch at the amplifier rear panel allows selecting the power on delay time. The On delay table shows possible switch settings and corresponding delay times.

ON DELAY	Delay time (in s)	ON DELAY	Delay time (in s)
0	0.52	8	1.05
1	0.59	9	1.15
2	0.63	A	1.25
3	0.69	B	1.40
4	0.75	C	1.49
5	0.84	D	1.55
6	0.90	E	1.61
7	0.95	F	1.69

Table 6.1: On delay

6.8 GPI/GPO

C Series amplifiers include two GPIs and one GPO.

GPI:

The GPI is used to change between two internal device presets. If the GPI 1 or GPI 2 is set to GND potential, the preset is switched from the original selected preset to the preset set for GPI 1 or GPI 2.

GPO:

The GPO is designed as a potential-free changeover switch (relay).

If power is on, GPO pin 3 and GPO pin 1 are shorted.

If the amplifier is turned off or a fault condition appears, GPO pin 3 and GPO pin 2 are shorted.

6.9 Power outputs

6.9.1 L Series amplifier

Cabling with two Speakon-type connectors in Normal mode

The first possibility in Normal mode is to use the two Speakon-type connectors, whereas speakers have to be connected to pins 1+ and 1- of the sockets. The correct connection is also indicated at the amplifiers rear panel.

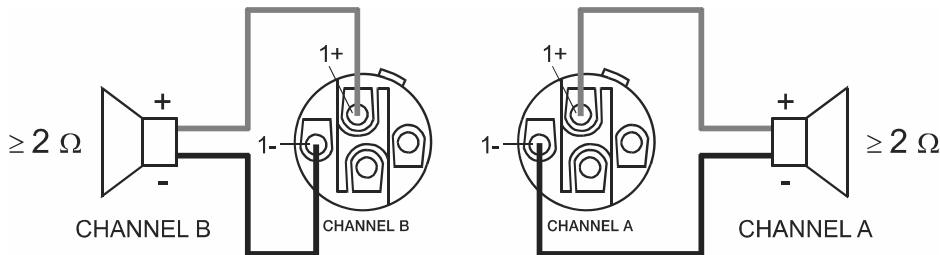

Figure 6.1: Normal mode

Bi-Amp cabling in Normal mode with Speakon-type connector

The second possibility for connecting the speakers when the power amplifier is operated in Normal mode is to only use the Speakon-type connector CHANNEL A and to connect one speaker cabinet to pins 1+ and 1-, as described above and the second cabinet to pins 2+ and 2-. Pins 2+ and 2- are only assigned at Speakon-type connector of CHANNEL A. Proceeding like this facilitates the cabling of speaker systems that are used in active 2-way operation (Bi-Amp). The correct connection is also indicated at the amplifiers rear panel.

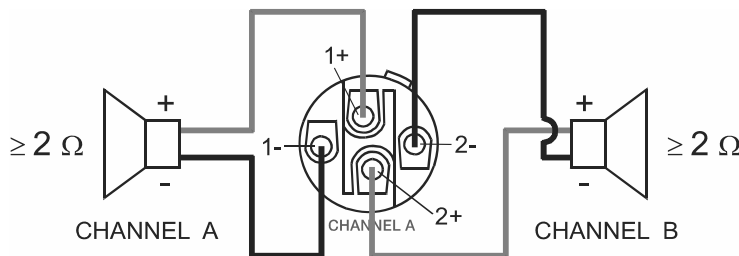

Figure 6.2: Bi-Amp cabling in Normal mode

Speakon CHANNEL B			Speakon CHANNEL A			
1+	1-	Connector	1+	1-	2+	2-
B+	B-	Signal	A+	A-	B+	B-

Table 6.2: Speaker connection using Speakon A and B connectors

Cabling with Speakon-type connector in Bridged mode

In Bridged mode both amp channels work in push-pull operation to provide doubled output voltage.

In bridged mode operation speaker connection has to be established using pins 1+ and 2- of the Speakon socket CHANNEL A. The correct connection is also indicated at the amplifiers rear panel.

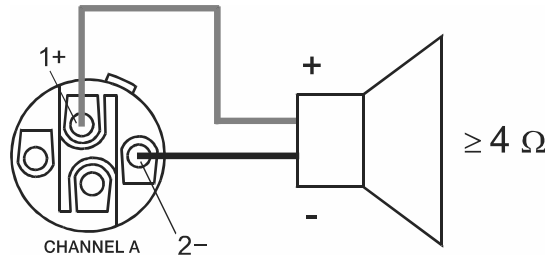

Figure 6.3: Bridged mode

	Speakon CHANNEL A	
Connector	1+	2-
Signal	Bridged+	Bridged-

Table 6.3: Speaker connection using Speakon A

Caution!



In Bridged mode operation, it is not allowable for the load connected to all below a value of 4 ohms. Extremely high voltages can be present at the output. The connected speaker systems must be able to handle such voltages. Make sure to completely read and fully observe power rating specifications of the speaker systems to be used and to check them against the output power capacity of the power amp.

Property damage and/or personal injury may occur.

6.9.2

C Series amplifier

Cabling with Euroblock-type connector in Normal mode

See illustration for connecting speakers in Normal mode. The correct connection is also indicated at the amplifiers rear panel.

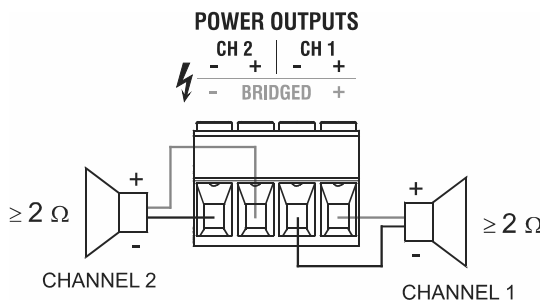

Figure 6.4: Normal mode

Cabling with Speakon-type connector in Bridged mode

In Bridged mode both amp channels work in push-pull operation to provide doubled output voltage.

In Bridged mode operation speaker connection has to be established using pins 1+ and 2-, see illustration. The correct connection is also indicated at the amplifiers rear panel.

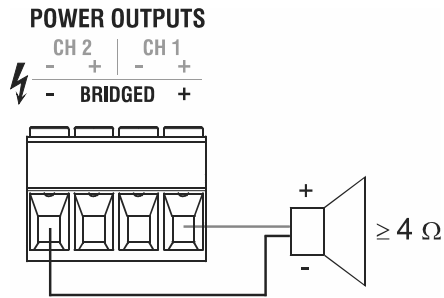

Figure 6.5: Bridged mode



Caution!

In Bridged mode operation, it is not allowable for the load connected to all below a value of 4 ohms. Extremely high voltages can be present at the output. The connected speaker systems must be able to handle such voltages. Make sure to completely read and fully observe power rating specifications of the speaker systems to be used and to check them against the output power capacity of the power amp.

Property damage and/or personal injury may occur.

6.10 Audio input cabling

6.10.1 Audio input cabling for XLR-type connectors

Inputs INPUT A and INPUT B are electronically balanced. The pin-assignment of XLR-type connectors is in accordance with the IEC standard 268.

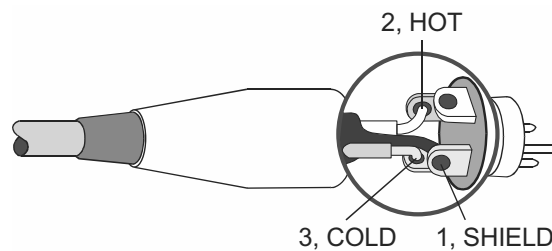

Figure 6.6: Balanced connection of input

Whenever possible, using balanced audio signal feeds at the input of the power amplifier is always preferred. Unbalanced connections should only be used if the cables are very short and no interfering signals are to be expected in the vicinity of the power amplifier. In this case, bridging the screen (shielding) and the pin of the inverting input inside of the connector is mandatory. Otherwise, a 6 dB drop in level could result. Due to their immunity against external interference sources, such as dimmers, mains connections, HF-control lines, etc., using balanced cabling and connections is always preferable.

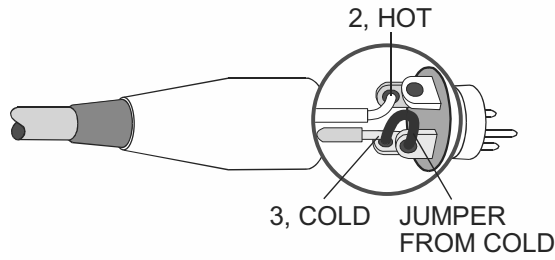

Figure 6.7: Unbalanced connection of input

Next to its input connector, each channel provides an individual XLR-type connector (OUTPUT A or OUTPUT B), which is connected in parallel to allow for comfortably daisy-chaining the audio signal for the connection of additional audio equipment.

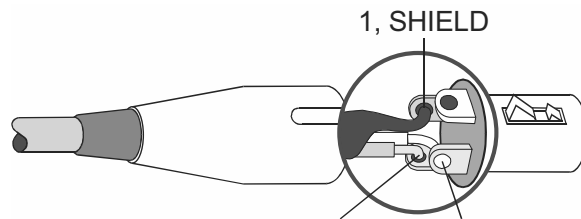

Figure 6.8: Balanced connection of output (Daisy-Chain)

6.10.2



Audio input cabling for Euroblock-type connectors

Inputs are electronically balanced. Whenever possible, using balanced audio signal feeds at the input of the power amplifier is always preferred. Unbalanced connections should only be used if the cables are very short and no interfering signals are to be expected in the vicinity of the power amplifier. In this case, bridging the screen (shielding) and the pin of the inverting input inside of the connector is mandatory. Otherwise, a 6 dB drop in level could result. Due to their immunity against external interference sources, such as dimmers, mains connections, HF-control lines, etc., using balanced cabling and connections is always preferable.

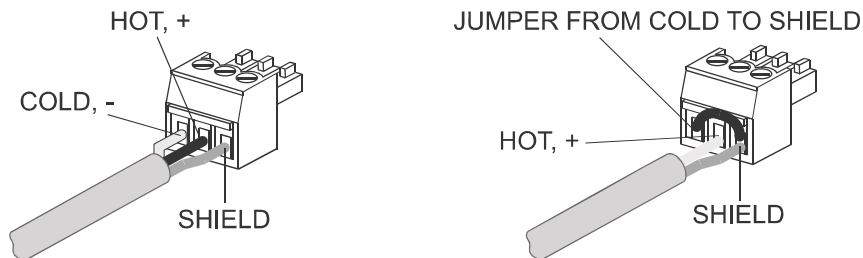

Figure 6.9: Balanced/unbalanced connection of input

7 Power amplifier menu navigation

7.1 Amplifier and DSP control

An integrated amplifier and DSP control menu allows the user to select multiple system settings on the power amplifier. When the power amplifier is powered on the home screens appears.

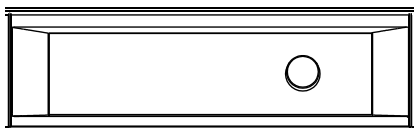

Figure 7.1: LCD control and monitoring interface

Preset No: Preset Name	
A: 0 dB (Default)	Range: Mute, -80 dB to 0 dB
B: 0 dB (Default)	Range: Mute, -80 dB to 0 dB

Table 7.1: Home screen

Preset No: Preset Name: If a recalled preset is edited the letter E is shown. Edited presets can be stored in one of the 50 User Presets.

Channel A or B: Icons in the home screen lines 2 and 3 indicate that the original loaded preset has been modified.

G = GEQ (Graphical Equalizer) in use

- E = EQ/PEQ (Parametric Equalizer) in use
- D = Delay in use

Accessing the amplifier DSP control menu

To **access the amplifier DSP controls menu**, do the following:

1. Push the **encoder knob**.
The DSP Control menu appears.
2. Turn the **encoder knob** to scroll through the **menu items**.
3. Push the **encoder knob** to select the menu item you want to modify.
The focus advances to the next parameter set.
4. Turn the **encoder knob** to scroll through the **parameters**.
5. Using the **encoder knob**, adjust the **parameters** to the desired value.
6. Push the **encoder knob** to confirm the modified parameter.
The parameter is changed to the current setting.
7. Repeat **steps 2** through **6** to modify additional DSP and system settings.
8. Select **EXIT** to return to the home screen.

7.2 DSP control menu

In the DSP menu structure "U_" indicates user defined presets and "F_" indicates factory settings. When firmware is updated the factory settings may change. Refer to the latest release notes for further information.

Preset	Load Preset	F1 --- F8/10**			
	Store Preset	U1 --- U50	U1 --- U50		
	Startup:	Last F1 -- F8/10* U1 --- U50	** See preset table		
AMP Setup	Mode:	Normal	Bridged		
	Routing A:	In A	In A		
	Routing B:	In B	In A In B In A+B		
DSP Edit	EQ A	EQ 1-5: Enable (On/Off), Type (PEQ, Loshelv, Hishelv, Hipass, Lopass), Frequency (20Hz - 20kHz), Gain (-18dB - +12dB), Quality (0.4 - 40.0), Slope (6dB/Oct, 12dB/Oct)			
	EQ B				
	Delay A:	0 ms	0 --- 650 ms	0 --- 680 ft	
	Delay B:	0 ms		0 --- 207 m	
	GEQ A:	OFF	ON		
	GEQ B:	OFF			
	LP/HP/Xover Freq.	30 - 300 Hz	Dependent on preset		
	Parameter:	Unlinked	Linked		
	GPI Config*	I1:	U1 (Linear Dual)	None	*C Series only!
		I2:	U1 (Linear Dual)	None F1 --- F8/10** U1 --- U50	
Load Monitor	Imp. A:	x.x Ohm / Open / Shorted / Invalid			
	Imp. B:	x.x Ohm / Open / Shorted / Invalid			
Lock	Front Control	On / Off			
	Preset	On / Off			
	AMP Setup	On / Off			
	DSP Edit	On / Off			
	USB	On / Off			
	Reset	On / Off			
	Lock	Pin Code: 0 0 0 0			
Options	Name:	Untitled			
	Brightness:	100%	0 --- 100 %		
	Dim Level:	50%	0 --- 100 %		
	Dim-Time:	Off	Off / 10 --- 60 sec.		
	Contrast:	5	0 --- 10		
	Delay unit:	ms	Meter - Feet - ms		
	Ambient:	20 °C / 68 °F	-20 °C --- +60 °C		
Reset	Default settings?	NO			
		YES	Erase User Presets?	NO YES	
Info	Name:	Untitled			
	Model:	L / C Series			
	Firmware:	x.x.xx			
	Ontime:	h:m	days : h, after 1000 h		
	Standby time*:	h:m			

Figure 7.2: DSP control menu

**Notice!**

Controlling multiple amplifiers via Dynacord control software: It is recommend to use a powered USB hub if the user wishes to control amplifiers with one cable to their computer. USB range extenders can also be used to remotely position the software control interface longer distances from the amplifiers.

Due to the great number of USB hubs and extenders, it is not possible to verify and test all brands and models for use with this product.

To find current user documentation, firmware, or software visit our product related information at www.dynacord.com.

7.3**Factory presets**

L Series and C Series amplifiers have a selection of factory presets on board. These are generic settings to be used as a starting point for configuration that do not require a dedicated speaker setting, but only some basic sound adjustments. The following content is based on the first release, future firmware updates might include additional or updated settings.

	Name	Input Routing		Parameters
F01	Linear Dual	In A > Out A	In B >Out B	All flat, no links
F02	Linear Mono A	In A > Out A	In A >Out B	All flat, no links
F03	Stereo Linked	In A > Out A	In B >Out B	All flat, CH A & B linked
F04	Sub & Top #1	In A > Out A	In A > Out B	BW18dB x-over @ 100Hz
F05	Sub Stereo #1	In A > Out A	In B >Out B	BW18dB Lo-Pass @ 100Hz
F06	Top Stereo #1	In A > Out A	In B > Out B	BW18dB Hi-Pass @ 100Hz
F07	Sub & Top #2	In A > Out A	In A > Out B	LR24dB x-over @ 100Hz
F08	Sub Stereo #2	In A > Out A	In B > Out B	LR24dB Lo-Pass@ 100Hz
F09	Top Stereo #2	In A > Out A	In B > Out B	LR24dB Hi-Pass @ 100Hz
F10	LPN Stereo	In A > Out A	In B > Out B	LPN filter for enhanced LF

Table 7.2: L Series factory presets

	Name	Input Routing		Parameters
F01	Linear Dual	In A > Out A	In B >Out B	All flat, no links
F02	Linear Mono A	In A > Out A	In A >Out B	All flat, no links
F03	Stereo Linked	In A > Out A	In B >Out B	All flat, CH A & B linked
F04	HP50Hz-Dual	In A > Out A	In B >Out B	Hi-Pass 18dB @ 50Hz
F05	HP50Hz-Mono	In A > Out A	In A >Out B	Hi-Pass 18dB @ 50Hz
F06	HP50Hz-Stereo	In A > Out A	In B >Out B	Hi-Pass 18dB @ 50Hz, CH A & B linked
F07	LPN Stereo	In A > Out A	In B >Out B	LPN filter for enhanced LF
C1300FDi				

	Name	Input Routing		Parameters
F08	70V Single	In A > Out A&B	Bridged Mode!	Hi-Pass 18dB @ 50Hz
C1800FDi				
F08	70V Dual	In A > Out A	In B > Out B	Hi-Pass 18dB @ 50Hz
F09	70V Mono	In A > Out A	In A > Out B	Hi-Pass 18dB @ 50Hz
F10	100V Single	In A > Out A&B	Bridged Mode!	Hi-Pass 18dB @ 50Hz
C2800FDi and C3600FDi				
F08	70V Dual	In A > Out A	In B > Out B	Hi-Pass 18dB @ 50Hz
F09	70V Mono	In A > Out A	In A > Out B	Hi-Pass 18dB @ 50Hz
F10	100V Dual	In A > Out A	In B > Out B	Hi-Pass 18dB @ 50Hz

Table 7.3: C Series factory presets

Edit factory preset: When a factory preset is recalled and edited this is marked with an E. Edited presets can be stored in one of the 50 User Presets.

Bridged configuration: If the amplifier is used in a bridged configuration, only channel A is shown.

Preset: Is used to load or store a device preset. In addition to 10 factory presets there are also 50 user presets available.

AMP Setup: Is used to select between normal operation and bridged operation.



Notice!

Bridge operation requires different cabling.

Routing: Is used to select input signal routing for channels A and B: A, B, or A+B (sum).

DSP Edit:

EQ (Equalizer) for channel A & B: five band adjustable parameters are as shown in table.

Delay set the audio delay per channel A or B individually up to 650 ms. Units can be selected in ms, meters, and feet in the Options.

GEQ this allows to bypass the Graphic EQ.



Notice!

The GEQ is only adjustable via remote control software.

LP/HP/Xover Freq: Factory presets with preset Hi-Pass/Lo-Pass or x-over frequencies is used to modify the frequency parameter in the range of 30 Hz to 300 Hz.

Parameters: Select between channels A&B to be linked (all changes on CH A affect CH B) or unlinked (changes on CH A do not affect CH B).

GPI Config (C Series only): Determines the two presets which can be toggled in-between using the GPI contact.

Load Monitor: When signal is present the actual impedance per channel is displayed. *Open* indicates that no speaker is connected. *Shorted* indicates a short circuit in the cabling. If the signal is too low for a measurement it indicates *Invalid*.

Lock menu: Restricts unauthorized access by locking access to the amplifier in different options. Using the lock feature affects changes to Front Control, Preset, AMP Setup, DSP Edit, USB and Reset function with a 4-digit pin code. Use the encoder knob to view the menu/function you want to lock.

**Notice!**

Keep your password in a safe place.

To unlock the amplifier if you've forgotten your password requires a service center activity.

Hint: If you lock the front panel control, all menus and parameters that could be accessed are blocked. The amp can still be accessed from a computer via the USB port. Changes via GPI are not affected by locking.

**Notice!**

If the amplifier is controlled via remote control software the first line in the display is showing *Remote Control* and the front panel access is locked.

Options: User preferences for brightness, dim levels, contrast, delay units and ambient temperature (for delay calculation) can be selected.

Reset: Returns the amplifier to the original factory settings. The option *Erase User Presets* allows the user to keep or erase the user presets within the reset. Available options for this selection are: No or YES.

**Notice!**

Performing a reset erases the user customized settings saved under the Store Preset option. The 50 user customized settings in the Store Preset option return to <EMPTY>.

Info: Displays the name of the amplifier, the amplifier model (e.g. L3600FD), firmware version and current ontime. C Series amplifiers have an additional parameter: Standby time.

For firmware updates, amplifier control software, and product related information visit our website: www.dynacord.com/software.

8 Technical data

Amplifier model	L1300FD/C1300FDi			
Load Impedance	2 Ω	2.6 Ω	4 Ω	8 Ω
Maximum Output Power, Single Channel	1100 W	950 W	660 W	350 W
Maximum Output Power, Dual Channel	1000 W	850 W	600 W	320 W
Maximum Output Power, Bridged	-	-	2000 W	1200 W
Maximum RMS Voltage Swing THD = 1%, 1 kHz	55.3 V			
Voltage Gain Ref.1 kHz	32.0 dB			
THD at 450 W/4 Ω MBW = 80 kHz, 1 kHz	< 0.05%			
IMD-SMPTE, 60 Hz, 7 kHz	< 0.1%			
DIM30, 3.15 kHz, 15 kHz	< 0.05%			
Maximum Input Level	+21 dBu			
Crosstalk ref. 1 kHz, at 100 W/4 Ω	< -80 dB			
Frequency Response, ref. 1 kHz	10 Hz to 21 kHz (± 1 dB)			
Input Impedance, Active Balanced	20 k Ω			
Signal to Noise Ratio Amplifier, A-weighted, ref to Max. Output Power @ 8 Ω	>104 dB			
Output Noise, A-weighted	< -68 dBu			
Output Stage Topology	Class AB			
Power Requirements	240 V, 230 V, 120 V or 100 V; 50 Hz to 60 Hz (factory configured)			
Power Consumption 1/8 Maximum Output Power @ 4 Ω	550 W			
Mains Fuse	240 V/230 V: T10AH; 120 V/100 V: T20AH			
Protection	Audio limiters, high temperature, DC, HF, Back-EMF, Peak current limiters, Inrush current limiters, Turn on delay			
Cooling	Front-to-rear, 3-stage-fans			
Ambient Temperature Limits	+5°C to +40°C (40°F to +105°F)			
Safety Class	I			

Amplifier model	L1300FD/C1300FDi
Color	Black
Dimensions (W x H x D), mm	483 x 88 x 462.4
Weight	12.9 kg (28.4 lb)
Remote Power ON /GPIO (C Series only)	Power remote via switch, delay time selectable Floating relay contacts (show protect mode) Inputs for preset selection
Signal Processing	FIR Filters, Audio Limiters Output delay per channel, 31 band GEQ per channel, PEQ per channel, Load impedance
Accessories	RMK15 (rear rack mount kit), Multi Amplifier Remote Control (MARC) software

Test signal for max. output power according IHF-A-202 (Dynamic-Headroom, burst 1 kHz/20 ms on/480 ms off/low level -20 dBu).

Amplifier model	L1800FD/C1800FDi			
Load Impedance	2 Ω	2.6 Ω	4 Ω	8 Ω
Maximum Output Power , Single Channel	1600 W	1300 W	950 W	480 W
Maximum Output Power , Dual Channel	1400 W	1200 W	850 W	450 W
Maximum Output Power , Bridged	-	-	2800 W	1700 W
Maximum RMS Voltage Swing THD = 1%, 1 kHz	65.1 V			
Voltage Gain Ref.1 kHz	32.0 dB			
THD at 600 W/4 Ω MBW = 80 kHz, 1 kHz	< 0.05%			
IMD-SMPTE , 60 Hz, 7 kHz	< 0.1%			
DIM30 , 3.15 kHz, 15 kHz	< 0.05%			
Maximum Input Level	+21 dBu			
Crosstalk ref. 1 kHz, at 100 W/4 Ω	< -80 dB			
Frequency Response , ref. 1 kHz	10 Hz to 21 kHz (± 1 dB)			
Input Impedance , Active Balanced	20 k Ω			

Amplifier model	L1800FD/C1800FDi
Signal to Noise Ratio Amplifier , A-weighted, ref to Max. Output Power @ 8 Ω	>105 dB
Output Noise , A-weighted	< -68 dBu
Output Stage Topology	Class AB
Power Requirements	240 V, 230 V, 120 V or 100 V; 50 Hz to 60 Hz (factory configured)
Power Consumption 1/8 Maximum Output Power @ 4 Ω	700 W
Mains Fuse	240 V/230 V: T12AH; 120 V/100 V: T25AH
Protection	Audio limiters, high temperature, DC, HF, Back-EMF, Peak current limiters, Inrush current limiters, Turn on delay
Cooling	Front-to-rear, 3-stage-fans
Ambient Temperature Limits	+5°C to +40°C (40°F to +105°F)
Safety Class	I
Color	Black
Dimensions (W x H x D), mm	483 x 88 x 462.4
Weight	15.2 kg (33.5 lb)
Remote Power ON/GPIO (C Series only)	Power remote via switch, delay time selectable Floating relay contacts (show protect mode) Inputs for preset selection
Signal Processing	FIR Filters, Audio Limiters Output delay per channel, 31 band GEQ per channel, PEQ per channel, Load impedance
Accessories	RMK15 (rear rack mount kit), Multi Amplifier Remote Control (MARC) software

Test signal for max. output power according IHF-A-202 (Dynamic-Headroom, burst 1 kHz/20 ms on/480 ms off/low level -20 dBu).

Amplifier model	L2800FD/C2800FDi			
Load Impedance	2 Ω	2.7 Ω	4 Ω	8 Ω
Maximum Output Power , Single Channel	2300 W	2000 W	1400 W	700 W
Maximum Output Power , Dual Channel	2200 W	1800 W	1300 W	650 W
Maximum Output Power , Bridged	-	-	4400 W	2600 W
Maximum RMS Voltage Swing THD = 1%, 1 kHz	78.8 V			

Amplifier model	L2800FD/C2800FDi
Voltage Gain Ref.1 kHz	32.0 dB
THD at 900 W/4 Ω MBW = 80 kHz, 1 kHz	< 0.05%
IMD-SMPTE , 60 Hz, 7 kHz	< 0.1%
DIM30 , 3.15 kHz, 15 kHz	< 0.05%
Maximum Input Level	+21 dBu
Crosstalk ref. 1 kHz, at 100 W/4 Ω	< -80 dB
Frequency Response , ref. 1 kHz	10 Hz to 21 kHz (±1 dB)
Input Impedance , Active Balanced	20 k Ω
Signal to Noise Ratio Amplifier , A-weighted, ref to Max. Output Power @ 8 Ω	>107 dB
Output Noise , A-weighted	< -68 dBu
Output Stage Topology	Class H
Power Requirements	240 V, 230 V, 120 V or 100 V; 50 Hz to 60 Hz (factory configured)
Power Consumption 1/8 Maximum Output Power @ 4 Ω	700 W
Mains Fuse	240 V/230 V: T15AH; 120 V/100 V: T25AH
Protection	Audio limiters, high temperature, DC, HF, Back-EMF, Peak current limiters, Inrush current limiters, Turn on delay
Cooling	Front-to-rear, 3-stage-fans
Ambient Temperature Limits	+5°C to +40°C (40°F to +105°F)
Safety Class	I
Color	Black
Dimensions (W x H x D), mm	483 x 88 x 462.4
Weight	16.2 kg (35.7 lb)
Remote Power ON/GPIO (C Series only)	Power remote via switch, delay time selectable Floating relay contacts (show protect mode) Inputs for preset selection

Amplifier model	L2800FD/C2800FDi
Signal Processing	FIR Filters, Audio Limiters Output delay per channel, 31 band GEQ per channel, PEQ per channel, Load impedance
Accessories	RMK15 (rear rack mount kit), Multi Amplifier Remote Control (MARC) software

Test signal for max. output power according IHF-A-202 (Dynamic-Headroom, burst 1 kHz/20 ms on/480 ms off/low level -20 dBu).

Amplifier model	L3600FD/C3600FDi			
Load Impedance	2 Ω	2.7 Ω	4 Ω	8 Ω
Maximum Output Power , Single Channel	3200 W	2700 W	1800 W	950 W
Maximum Output Power , Dual Channel	3000 W	2500 W	1700 W	900 W
Maximum Output Power , Bridged	-	-	6000 W	3400 W
Maximum RMS Voltage Swing THD = 1%, 1 kHz	90.6 V			
Voltage Gain Ref.1 kHz	32.0 dB			
THD at 1200 W/4 Ω MBW = 80 kHz, 1 kHz	< 0.05%			
IMD-SMPTE , 60 Hz, 7 kHz	< 0.1%			
DIM30 , 3.15 kHz, 15 kHz	< 0.05%			
Maximum Input Level	+21 dBu			
Crosstalk ref. 1 kHz, at 100 W/4 Ω	< -80 dB			
Frequency Response , ref. 1 kHz	10 Hz to 21 kHz (± 1 dB)			
Input Impedance , Active Balanced	20 k Ω			
Signal to Noise Ratio Amplifier , A-weighted, ref to Max. Output Power @ 8 Ω	>109 dB			
Output Noise , A-weighted	< -68 dBu			
Output Stage Topology	Class H			
Power Requirements	240 V, 230 V, 120 V or 100 V; 50 Hz to 60 Hz (factory configured)			

Amplifier model	L3600FD/C3600FDi
Power Consumption 1/8 Maximum Output Power @ 4 Ω	850 W
Mains Fuse	240 V/230 V: T15AH; 120 V/100 V: T30AH
Protection	Audio limiters, high temperature, DC, HF, Back-EMF, Peak current limiters, Inrush current limiters, Turn on delay
Cooling	Front-to-rear, 3-stage-fans
Ambient Temperature Limits	+5°C to +40°C (40°F to +105°F)
Safety Class	I
Color	Black
Dimensions (W x H x D), mm	483 x 88 x 462.4
Weight	18.2 kg (40.1 lb)
Remote Power ON/GPIO (C Series only)	Power remote via switch, delay time selectable Floating relay contacts (show protect mode) Inputs for preset selection
Signal Processing	FIR Filters, Audio Limiters Output delay per channel, 31 band GEQ per channel, PEQ per channel, Load impedance
Accessories	RMK15 (rear rack mount kit), Multi Amplifier Remote Control (MARC) software

Test signal for max. output power according IHF-A-202 (Dynamic-Headroom, burst 1 kHz/20 ms on/480 ms off/low level -20 dBu).

8.1 C Series direct drive load capability

The direct drive load capability is a measure for the total wattage that can be driven in 70 V/100 V operation mode. A load capability value of 1250 watts means that this amplifier can drive e.g. 50 loudspeakers at a voltage tap of 25 watts. The dB value in parentheses indicates the delta to maximum modulation. In cases where the maximum modulation is not required you can use the smaller amplifier model.

Model	Load Capability Dual Channel		Load Capability Bridge Mode	
	70V Operation	100V Operation	70V Operation	100V Operation
C3600FDi	Not recommended ¹	2 x 2500 W (-1.5 dB)	Not recommended ¹	
C2800FDi	2 x 1250 W (0.0 dB)	2 x 2500 W (-3.0 dB)	Not recommended ¹	1 x 1250 W (0.0 dB)

Model	Load Capability Dual Channel		Load Capability Bridge Mode	
C1800FDi	2 x 1250 W (-1.5 dB)	Not available ²	Not recommended ¹	1 x 1250 W (-1.5 dB)
C1300FDi	Not available ²		1 x 625 W (0.0 dB)	Not available ²

Table 8.1: C Series direct drive load capability

¹This operation mode is not recommended due to the efficiency reasons. Please use the next smaller amplifier for this mode.

²Direct drive mode not available for this configuration.

**Notice!**

100 V: 2 x 2500 W means each channel of the amplifier may be loaded with a maximum 2500 W loudspeaker loads.

For example, 50x loudspeakers per channel, each loudspeaker with a power rating of 50 W/100 W.

8.2**Mains operation & resulting temperature**

The power drawn from the mains network is converted into output power to feed the connected loudspeaker systems and into heat. The difference between power consumption and dispensed power is called power dissipation (Pd). The amount of heat resulting from power dissipation might remain inside of a rack-shelf and needs to be diverted using appropriate measures.

Mains operation & resulting temperature tables allow the determination of power supply and cabling requirements. The tables are meant as auxiliary means for calculating temperatures inside of a rack-shelf system/cabinet and the ventilation efforts necessary.

The column Pd lists the leakage power in relation to different operational states. The column BTU/hr lists the dispensed heat amount per hour. Power consumption is direct proportional for other mains voltages. The following conversion factors are meant for easy conversion: 100 V = 2.3; 120 V = 1.9; 240 V = 0.96.

Power consumption

C1300FDi Output Power	U _{mains} [V]	I _{mains} ⁽⁵⁾ [A]	P _{mains} [W]	P _{out} [W]	Pd ⁽⁴⁾ [W]	BTU/hr ⁽³⁾
Idle	230	0.5	43	-	43	146
1/8 Max. Output Power @ 8Ω ⁽²⁾	230	2.1	330	2 x 40	250	853
1/8 Max. Output Power @ 4Ω ⁽²⁾	230	3.5	572	2 x 75	420	1435
1/8 Max. Output Power @ 2,66Ω ⁽²⁾	230	4.7	808	2 x 106	596	2036
1/8 Max. Output Power @ 2Ω ⁽²⁾	230	5.4	980	2 x 125	730	2490
1/8 Max. Output Power @ 4Ω ⁽¹⁾	230	3.9	630	2 x 75	480	1638
Rated Output Power @ 8Ω ⁽¹⁾	230	4.4	730	2 x 200	330	1126

C1300FDi Output Power	U_{mains} [V]	I_{mains}⁽⁵⁾ [A]	P_{mains} [W]	P_{out} [W]	P_d⁽⁴⁾ [W]	BTU/hr⁽³⁾
Rated Output Power @ 4Ω ⁽¹⁾	230	7.6	1400	2 x 400	600	2047
1/8 70V/625W (8Ω) Bridged Mode ⁽²⁾	230	2.7	438	1 x 78	360	1228

Table 8.2: C1300FDi power consumption

C1800FDi Output Power	U_{mains} [V]	I_{mains}⁽⁵⁾ [A]	P_{mains} [W]	P_{out} [W]	P_d⁽⁴⁾ [W]	BTU/hr⁽³⁾
Idle	230	0.4	51	-	51	174
1/8 Max. Output Power @ 8Ω ⁽²⁾	230	3.0	472	2 x 56	360	1230
1/8 Max. Output Power @ 4Ω ⁽²⁾	230	4.8	780	2 x 106	568	1938
1/8 Max. Output Power @ 2,66Ω ⁽²⁾	230	6.6	1118	2 x 150	818	2792
1/8 Max. Output Power @ 2Ω ⁽²⁾	230	7.5	1325	2 x 175	975	3326
1/8 Max. Output Power @ 4Ω ⁽¹⁾	230	5.3	880	2 x 106	668	2279
Rated Output Power @ 8Ω ⁽¹⁾	230	5.8	970	2 x 250	470	1604
Rated Output Power @ 4Ω ⁽¹⁾	230	10.1	1830	2 x 500	830	2832
1/8 70V/1250W (4Ω) Dual Channel ⁽²⁾	230	5.7	940	2 x 156	628	2145
1/8 100V/1250W (8Ω) Bridged Mode ⁽²⁾	230	4.3	693	1 x 156	537	1832

Table 8.3: C1800FDi power consumption

C2800FDi Output Power	U_{mains} [V]	I_{mains}⁽⁵⁾ [A]	P_{mains} [W]	P_{out} [W]	P_d⁽⁴⁾ [W]	BTU/hr⁽³⁾
Idle	230	0.4	51	-	51	174
1/8 Max. Output Power @ 8Ω ⁽²⁾	230	3.0	445	2 x 81	283	966
1/8 Max. Output Power @ 4Ω ⁽²⁾	230	5.3	828	2 x 163	503	1716
1/8 Max. Output Power @ 2,66Ω ⁽²⁾	230	6.7	1120	2 x 225	670	2289
1/8 Max. Output Power @ 2Ω ⁽²⁾	230	8.2	1446	2 x 275	896	3057
1/8 Max. Output Power @ 4Ω ⁽¹⁾	230	4.3	696	2 x 163	371	1266
Rated Output Power @ 8Ω ⁽¹⁾	230	8.1	1400	2 x 400	600	2047
Rated Output Power @ 4Ω ⁽¹⁾	230	14.5	2720	2 x 800	1120	3822
1/8 70V/1250W (4Ω) Dual Channel ⁽²⁾	230	5.1	835	2 x 156	524	1788

C2800FDi Output Power	U_{mains} [V]	I_{mains}⁽⁵⁾ [A]	P_{mains} [W]	P_{out} [W]	P_d⁽⁴⁾ [W]	BTU/hr⁽³⁾
1/8 70V/2500W (4Ω) Dual Channel ⁽²⁾	230	7.9	1344	2 x 313	718	2449
1/8 100V/1250W (8Ω) Bridged Mode ⁽²⁾	230	3.2	492	1 x 156	336	1146

Table 8.4: C2800FDi power consumption

C3600FDi Output Power	U_{mains} [V]	I_{mains}⁽⁵⁾ [A]	P_{mains} [W]	P_{out} [W]	P_d⁽⁴⁾ [W]	BTU/hr⁽³⁾
Idle	230	0.5	57	-	57	194
1/8 Max. Output Power @ 8Ω ⁽²⁾	230	3.7	565	2 x 113	340	1160
1/8 Max. Output Power @ 4Ω ⁽²⁾	230	6.8	1100	2 x 213	675	2300
1/8 Max. Output Power @ 2,66Ω ⁽²⁾	230	8.9	1655	2 x 313	1030	3515
1/8 Max. Output Power @ 2Ω ⁽²⁾	230	10.8	1945	2 x 375	1195	4075
1/8 Max. Output Power @ 4Ω ⁽¹⁾	230	5.4	850	2 x 213	425	1450
Rated Output Power @ 8Ω ⁽¹⁾	230	10.7	1850	2 x 550	750	2560
Rated Output Power @ 4Ω ⁽¹⁾	230	19.1	3600	2 x 1100	1400	4780
1/8 100V/2500W (4Ω) Dual Channel ⁽²⁾	230	8.7	1426	2 x 313	800	2730

Table 8.5: C3600FDi power consumption

⁽¹⁾Sine Signal Modulation (1 kHz)

⁽²⁾Pink Noise according to EN60065/7.Edition

⁽³⁾1BTU = 1055.06J = 1055.06Ws

⁽⁴⁾P_d = Power dissipation

⁽⁵⁾The following conversion factors are meant for easy conversion of mains current: 100V = 2.3; 120V = 1.9; 240V = 0.96

Power consumption is direct proportional for other mains voltages.

See also

- Operating voltage, page 14
- Ventilation, page 15

8.3 Block diagrams

 SAFETY COMPONENT MUST BE REPLACED BY ORIGINAL PARTS

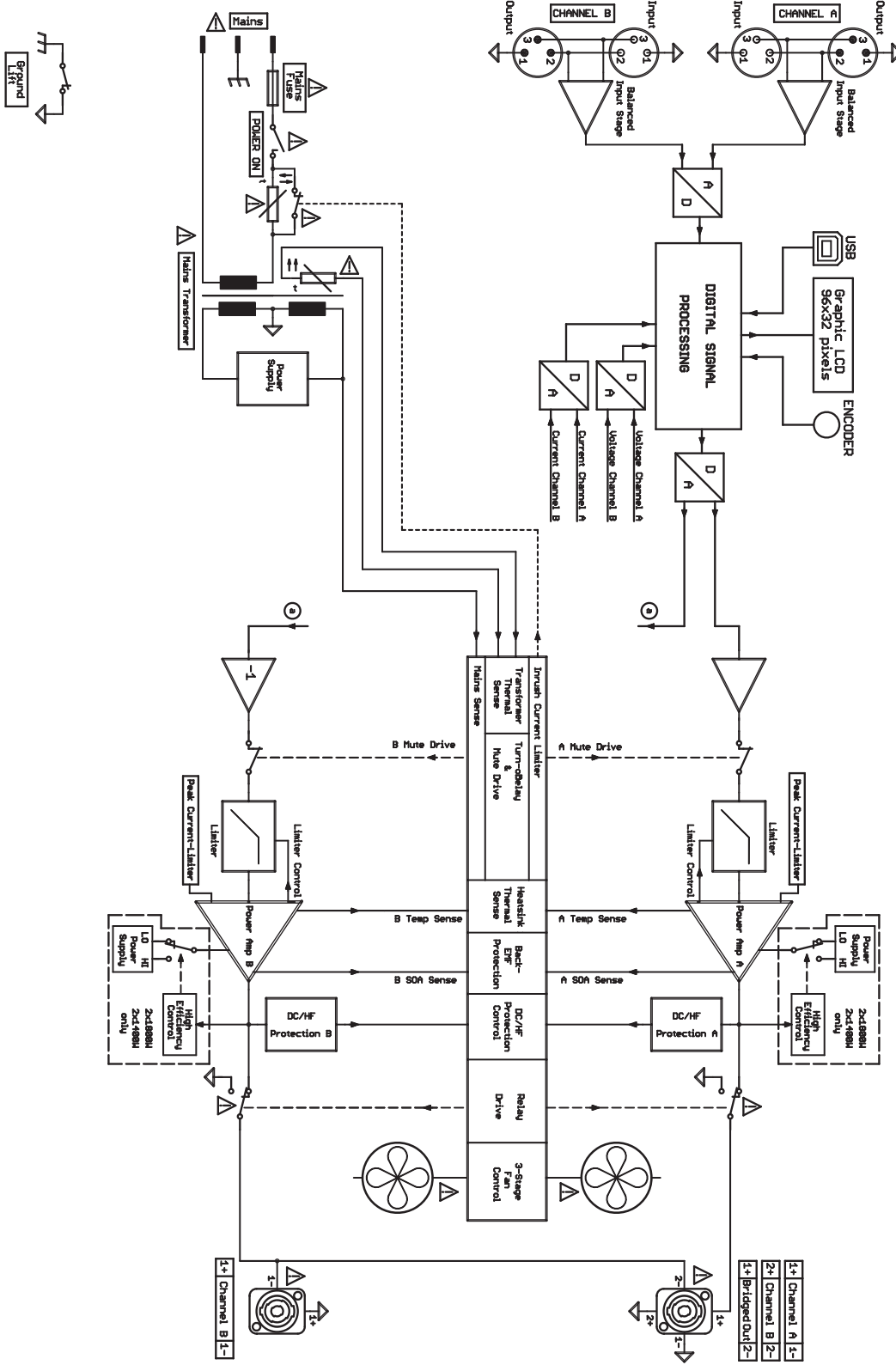

Figure 8.1: L Series amplifier block diagram

8.4 Dimensions

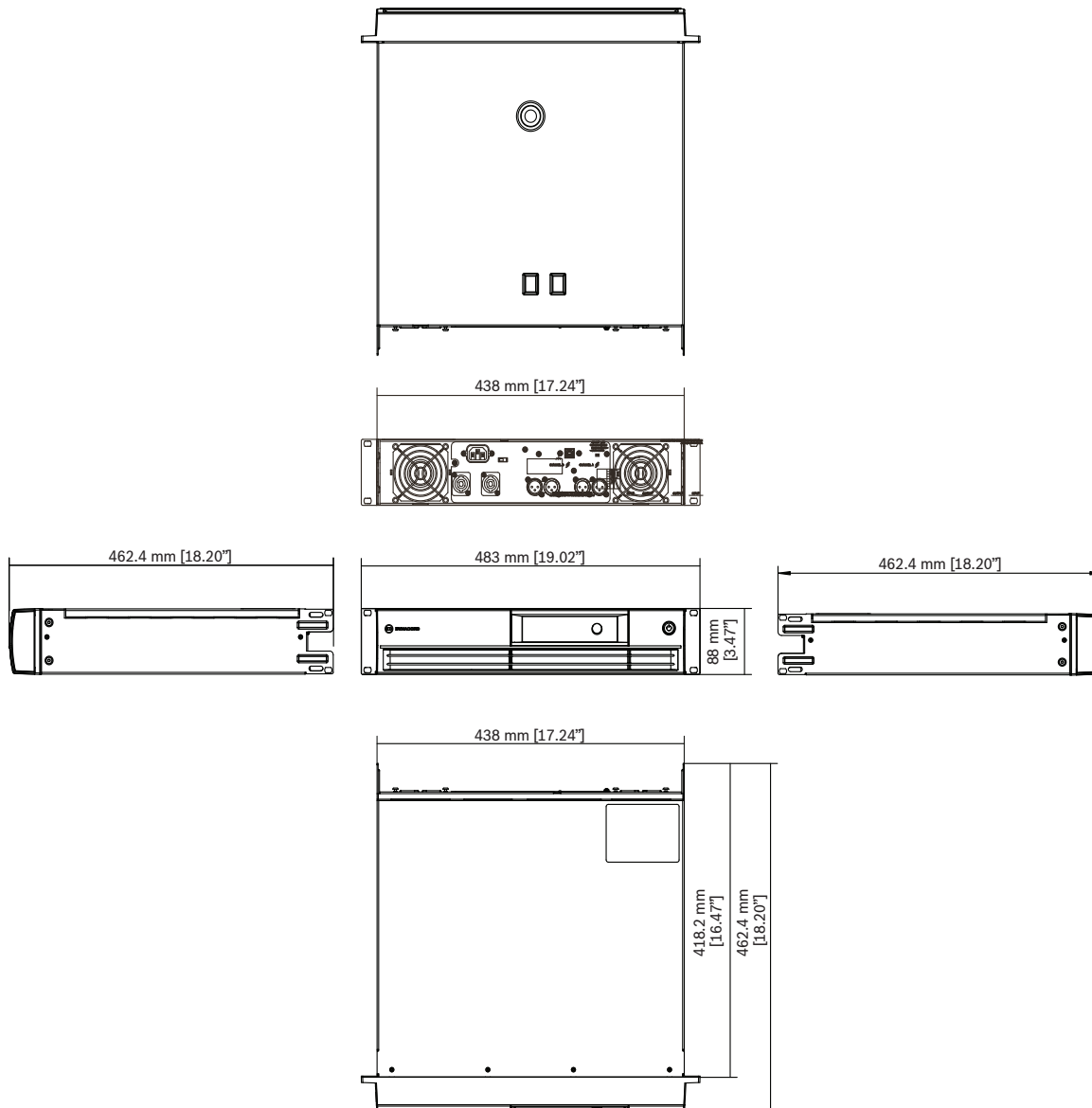

Figure 8.3: L Series and C Series amplifier dimensions (L Series shown)



Bosch Security Systems, Inc.

130 Perinton Parkway
Fairport, NY 14450
USA

www.dynacord.com

© Bosch Security Systems, Inc., 2017

