

Important Safety Instructions



1. Do not expose this apparatus to rain, moisture, dripping or splashing and that no objects filled with liquids, such as vases, shall be placed on the apparatus.



2. Do not install or place this unit in a bookcase, built-in cabinet or in another confined space. Ensure the unit is well ventilated.



3. To prevent risk of electric shock or fire hazard due to overheating, do not obstruct the unit's ventilation openings with newspapers, tablecloths, curtains, and similar items.



4. Do not install near any heat sources such as radiators, heat registers, stoves, or other apparatus (including amplifiers) that produce heat.



5. Do not place sources of naked flames, such as lighted candles, on the unit.



6. Clean this apparatus only with dry cloth.



7. Unplug this apparatus during lightning storms or when unused for long periods of time.

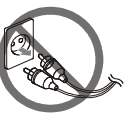

8. Protect the power cord from being walked on or pinched particularly at plugs.



9. Only use attachments / accessories specified by the manufacturer.



Table of Contents

Introduction.....	4
Overview	4
Features	4
Package Contents	5
Panel Description	6
Front Panel.....	6
Rear Panel	7
Installation and Wiring	8
Installation	8
Wiring.....	9
Key Functions	10
Screen Mirroring	10
(1) Screen Mirroring over Airplay (for Apple Devices)	10
(2) Screen Mirroring over Smart View (for Android Phones & Windows PCs)	11
(3) Screen Mirroring over Miracast (for Android Phones & Windows PCs)	12
(4) Screen Mirroring over HT-VOYAGER2 (HT Wireless Dongle)	13
(5) Wireless Conference over HT-VOYAGER2 (HT Wireless Dongle)	13
Dual View Display	15
Automatic Signal Switching.....	15
Guide Screen.....	16
OSD	17
Web GUI	18
General Page.....	20
Device Name	20
Wired Network.....	20
Wi-Fi Settings	22
BYOD.....	23
USB Switching.....	24
System Settings	24
Video Settings Page	25
Output Settings	25
State & Switch	26
Alias	26
Video Switching.....	27
Display Control Page	28
CEC.....	28
RS232.....	29
Policy	30
Power On/Off Device.....	31
Support Page.....	31
Version Info	31
Firmware Update.....	31
Firmware Upgrade.....	32
Troubleshooting	33
Specifications.....	34

Introduction

OVERVIEW

The HT-RANGER2 is a high-performance BYOD presentation switcher with both wireless presentation and two-way wireless conferencing capabilities. It includes a built-in Wi-Fi module and offers multiple connection options, including AirPlay, Miracast, Smart View, HT-VOYAGER2 and physical HDMI and USB-C ports. Connecting to the HT-RANGER2 using any of these methods can project the video from the connected device to the connected display, in either full screen mode or dual view mode.

The HT-RANGER2, when paired and used with the HT-VOYAGER2 dongle, will also wirelessly send microphone audio and camera video connected via USB to to the laptop. This feature allows users to participate in a Teams or Zoom call completely wirelessly.

The HT-RANGER2 includes multiple features such as automatic signal switching, CEC, Guide Screen, and OSD display.

FEATURES

- 2x1 Presentation switcher
- USB-C port with video input, USB3.0, charging, and Ethernet
- Dual view presentation
- Built-in Wi-Fi module for wireless connectivity with devices over AirPlay, Miracast, Smart View, and HT-VOYAGER2
- Supports HDMI input resolutions up to 4K@30Hz 4:4:4.
- Supports HDMI output resolutions up to 4K@60Hz 4:4:4 (4:2:0 on HDBT out)
- 4 input and 2 output USB3.0 switcher
- Built-in Ethernet switch with security design
- Analog audio output
- Detailed On Screen Display (OSD) information
- Device control using Web UI and Telnet API
- Laptops connected to the HT-RANGER2 using the USB-C interface can access USB peripheral devices (i.e. cameras, microphones) connected to USB-A ports on the HT-RANGER2.

Package Contents

- 1 x Switcher
- 4 x Wi-Fi Antennas
- 1 x DC 20V 6A Power Adapter with US Pins
- 4 x Mounting Brackets (with Screws)
- 1 x 3-pin 3.5mm Phoenix connector
- 1 x 5-pin 3.5mm Phoenix connector

Panel Description

FRONT PANEL

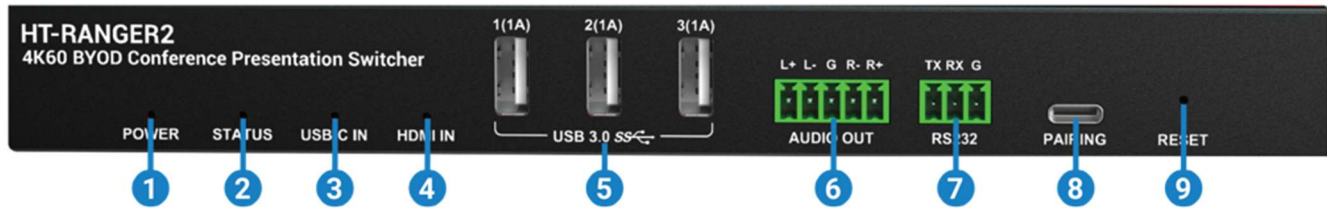

No.	Name	Description
1	Power LED	Solid green LED when the HT-RANGER2 is powered on.
2	Status LED	<ul style="list-style-type: none"> Solid green LED: The HT-RANGER2 is outputting at least one video source. Off: The HT-RANGER2 is in standby mode.
3, 4	Input Source LEDs	<ul style="list-style-type: none"> Solid green LED: The corresponding video input source signal is connected and is being displayed. Blinking green LED: The corresponding video input source signal is being output but the signal is not valid. Off: The switcher is in standby mode, or the corresponding video input source signal is not connected.
5	USB 3.0	3 x USB 3.0 Type-A ports for the following two functions: <ul style="list-style-type: none"> Connect to USB peripherals (e.g. keyboard, mouse, touch screen, camera, speakerphone). (Each USB-A port outputs up to 1A current.) Connect to a USB flash drive for firmware upgrade.
6	AUDIO OUT	5-Pin Phoenix connector. Connect to an audio receiver for balanced analog audio output.
7	RS-232	3-Pin Phoenix connector for the following two functions: <ul style="list-style-type: none"> Connect to a peripheral device to be controlled (e.g. projector) Connect to a 3rd party controller to control this device
8	PAIRING	USB-C port. Used to pair the HT-VOYAGER2 dongle.
9	RESET	Recessed button for the following two functions: <ul style="list-style-type: none"> Short press the button to show OSD on the connected display Press and hold the button for at least five seconds and then release to restore factory defaults.

REAR PANEL

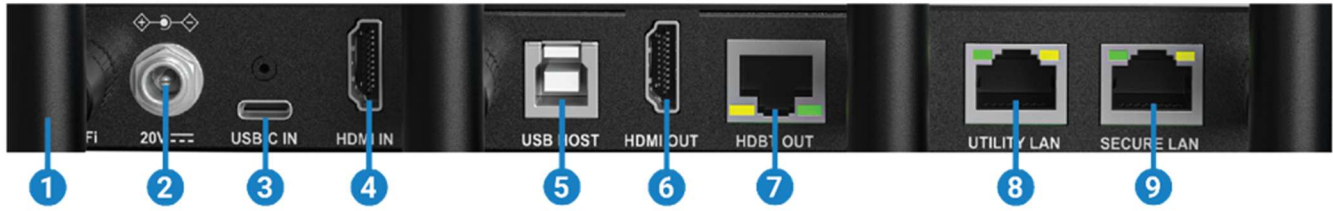

No.	Name	Description
1	Wi-Fi	Connect to the four Wi-Fi antennas provided for access to Miracast and the soft AP function.
2	20V	Connect to the DC 20V power adapter provided.
3	USB-C IN	USB-C port that supports USB-C video in, charging (up to 60W), 1000BaseT Ethernet connection and USB3.0 Host
4	HDMI IN	HDMI Type-A input port for HDMI source
5	USB HOST	USB 3.0 Type-B port for USB host device
6	HDMI OUT	HDMI Type-A output port for connection to an HDMI display.
7	HDBT OUT	RJ-45 port. Connect to an HDBT receiver, such as the DSCV-70-RX.
8	UTILITY LAN	2 x RJ-45 ports. Connect to network devices for LAN control, network access, and Airplay Mirroring signal input.
9	SECURE LAN	

Installation and Wiring

INSTALLATION

Note: Before installation, please ensure the device is disconnected from the power source.

Attaching Antennas

1. Attach the included antenna to the threaded connector and screw it in clockwise.

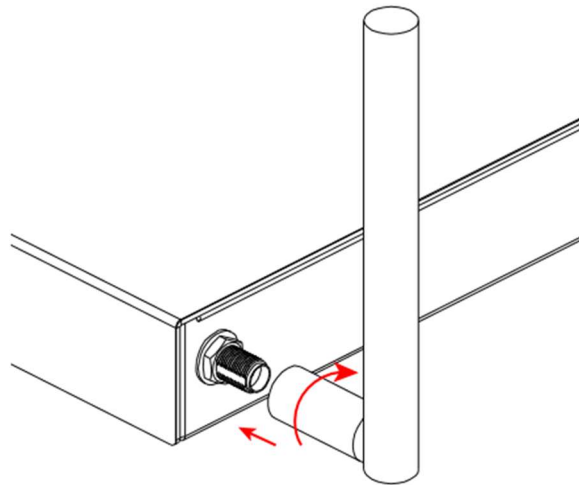

2. Repeat the above step for the other antennas.

Attaching Installation Brackets

1. Attach the included installation bracket to the enclosure using the screws provided.

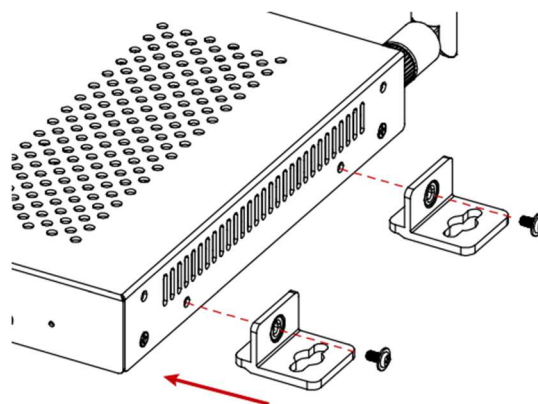

2. Repeat the step for the other side of the device.
3. Attach the brackets to the desired install surface (installation hardware not included).

WIRING

Warnings:

- Before wiring, ensure all devices are disconnected from power.
- When wiring, carefully connect and disconnect the cables, ensuring each connector is properly seated.

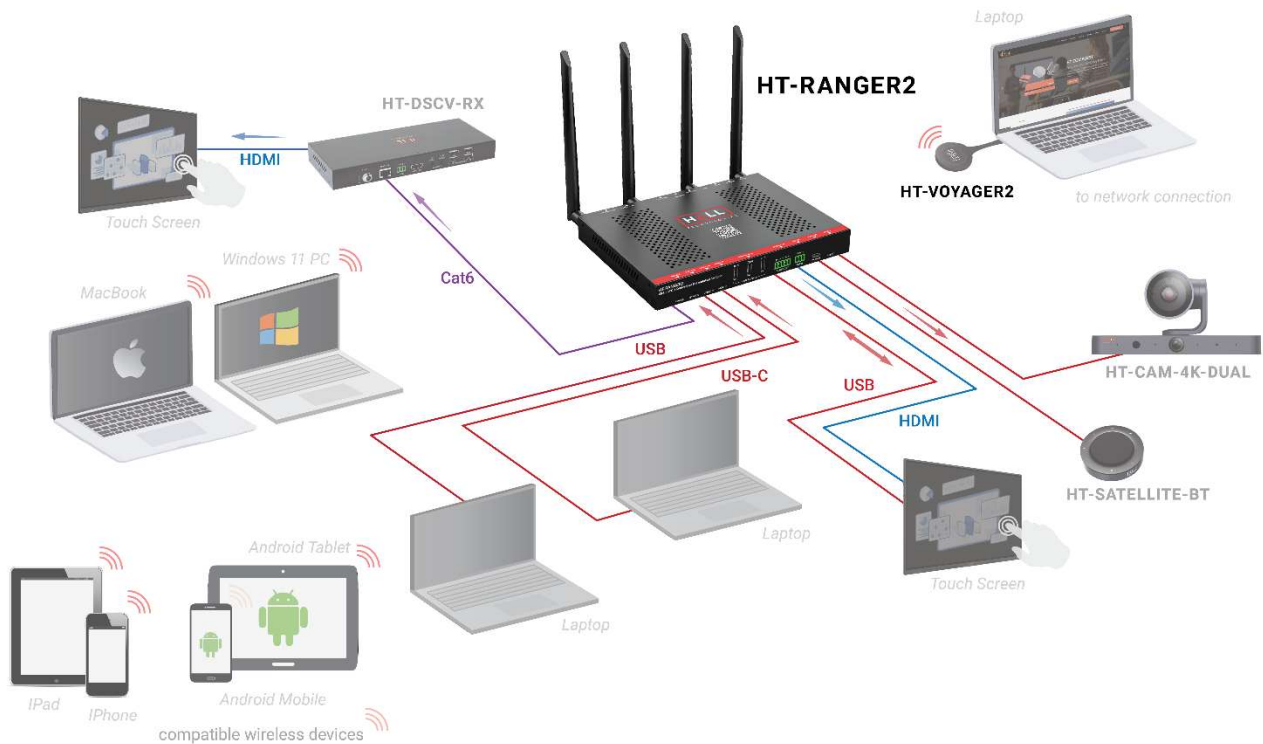

In the above application diagram:

- Two PCs are connected to the USB-C IN and HDMI IN.
- Two wired PCs can access the USB camera and speakerphone through the built-in USB switcher.
- Two wired PCs can access the LAN through the built-in Ethernet switch.
- Apple devices can wirelessly project to HT-RANGER2 by Airplay Mirroring.
- Android mobile phones and Windows 10 PCs can wirelessly project to HT-RANGER2 using Miracast.
- Any devices with USB-C video output can wirelessly project to HT-RANGER2 using the HT-VOYAGER2 dongle.

Key Functions

The switcher supports multiple functions such as screen mirroring, dual view display, automatic signal switching, Guide Screen and OSD, providing simple use of the system.

SCREEN MIRRORING

With screen mirroring support, the HT-RANGER2 allows you to share your mobile devices' content wirelessly over AirPlay Mirroring, Miracast, Smart View, and HT-Voyager. In this manual, mobile devices available for screen mirroring are referred to as "screen mirroring sources", which include Apple devices (iPhone/iPad/Mac), Android phones, Windows PCs, and HT-VOYAGER2.

1. Screen mirroring over airplay

Using an iPhone 8 (iOS 15.2) for example:

1. Connect your iPhone to the soft AP of the device.
 - ⇒ **Soft AP SSID:** this should be the same as the device name which can be obtained from the OSD at the upper right corner of the display screen. By default, it is set as **HT-RANGER2**.
 - ⇒ **Password:** this password can be set through Web UI or Telnet API and can be obtained from the OSD at the bottom right corner of the display screen. By default, it is set as **12345678**.
2. Slide up from the bottom of the iPhone's screen to show the control center. Click **Screen Mirroring** and choose the device name in the pop-up list.

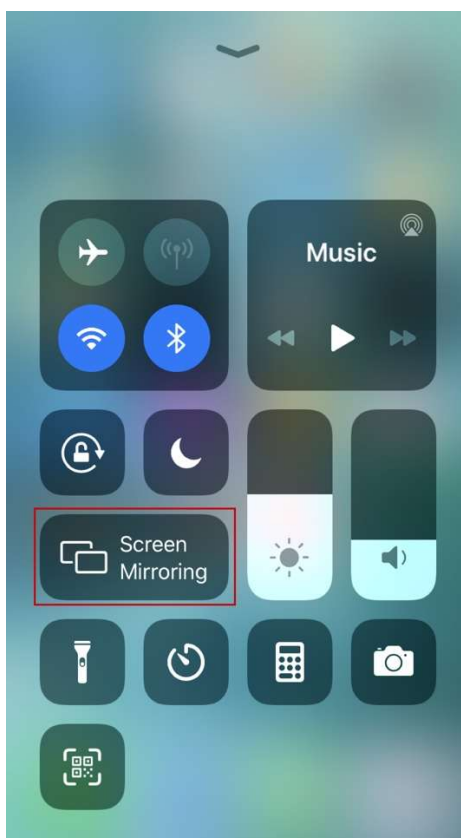

3. HT-RANGER2 now displays your iPhone's screen.
4. To disconnect iPhone from the device: click "Stop Mirroring". The display stops displaying your iPhone's screen.

2. Screen mirroring over Smart View

For Android mobile (using Samsung Galaxy S24 for example):

1. Enable the Wi-Fi or WLAN feature of the mobile.
2. Slide down from the top of the screen and click the **Smart View** icon in the pop-up interface.

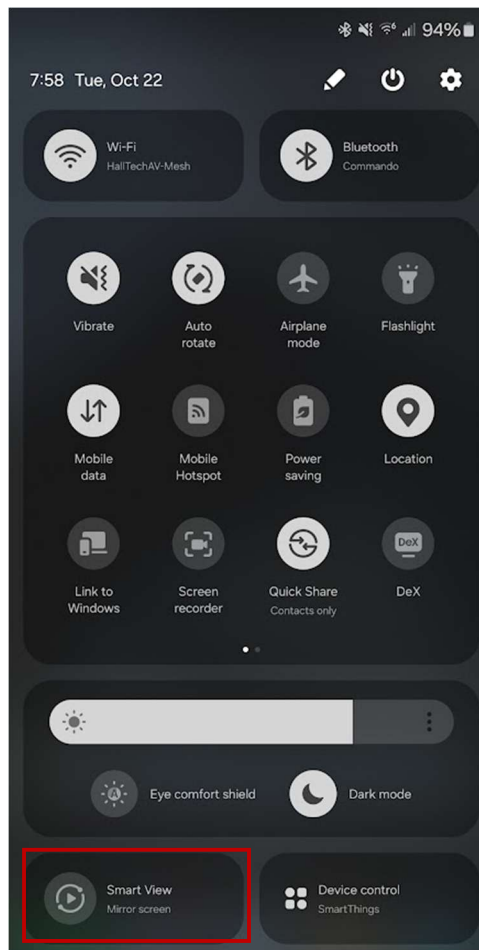

3. The Smart View window appears and starts to search for Miracast receiver. Click the HT-RANGER2 device name in the search result and the device will output the mobile screen.

3. Screen mirroring over Miracast

For Windows 10 PC or higher:

1. Enable the Wi-Fi or WLAN feature of your PC.
2. On your PC, press the combination keys  + K to select the HT-RANGER2 from the pop-up menu.
3. To disconnect PC from the device: click **Disconnect**.

Note:

- The icon and interface of the Miracast function may vary on different computers.
- Some Windows 10 computers may fail to perform screen mirroring with Miracast due to compatibility issues.

Tip: Both the AirPlay mirroring and Miracast support access code. If you see the PIN entry window

appears on your devices, input the access code which can be obtained through OSD. (See “[OSD](#)” section for more information.)

4. Screen mirroring over HT-VOYAGER2

HT-VOYAGER allows you to share your laptop’s content on the display screen without installing any additional software. Simply plug in the HT-VOYAGER2 into USB-C and click the button. For more information, see the user guide of HT-VOYAGER2.

Steps to share laptop’s screen on the display using HT-VOYAGER2:

1. Pair the HT-VOYAGER2 with the switcher.

Connect the HT-VOYAGER2 to the PAIRING port of the switcher for pairing. Once pairing is completed, “Pairing successful” appears on the display screen. (This will take around 20 seconds to complete.)

2. Connect the HT-VOYAGER2 to a laptop.

The HT-VOYAGER2 will start running when connected into a laptop and will automatically connect to the switcher’s soft AP. Once the HT-VOYAGER2 connects to the switcher successfully, the HT-VOYAGER2 LED stops blinking and will be solid blue.

3. To mirror the laptop, press the HT-VOYAGER2’s projecting button. To display laptop’s screen in full screen, press and hold the button for at least 5 seconds. When projecting the LED will be a dimmer blue.

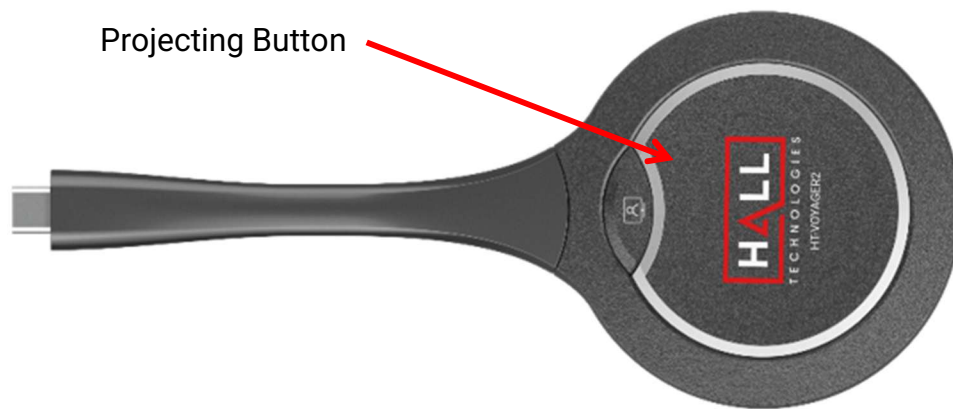

Note: For more information about HT-VOYAGER2, see the HT-VOYAGER2 user guide.

5. Wireless Conference over HT-VOYAGER2

The wireless conference function enables a laptop to access the USB conference peripherals (such as a USB camera, USB microphone, etc.) attached to the switcher wirelessly using the HT-VOYAGER2.

Steps to using this feature:

1. Connect USB conference peripherals to the USB-A ports on the HT-RANGER2.
2. Pair the HT-VOYAGER2 with the switcher.

Connect the HT-VOYAGER2 to the PAIRING port of the switcher for pairing. Once pairing is completed, "Pairing successful" appears on the display screen. (This will take a few seconds.)

3. Connect the HT-VOYAGER2 to a laptop.

The HT-VOYAGER2 will start running when connected into a laptop and will automatically connect to the switcher's soft AP. Once the HT-VOYAGER2 connects to the switcher successfully, the HT-VOYAGER2 LED stops blinking and will be solid blue.

4. Press the Wireless Conference button on the HT-VOYAGER2 to connect between the laptop and the USB devices wirelessly. Pressing this will run a software application on the connected PC.

Wireless Conference Button

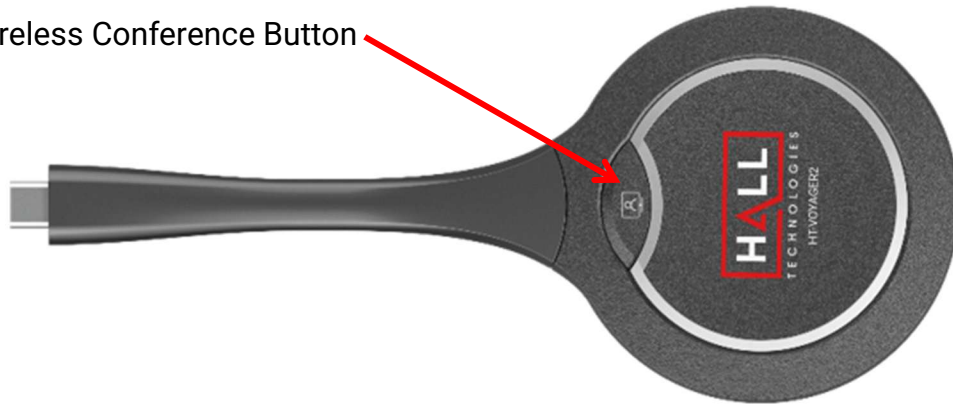

Note: For more information about HT-VOYAGER2, see the HT-VOYAGER2 user guide.

DUAL VIEW DISPLAY

By default, the HT-RANGER2 allows up to two video sources to be displayed on a single screen.

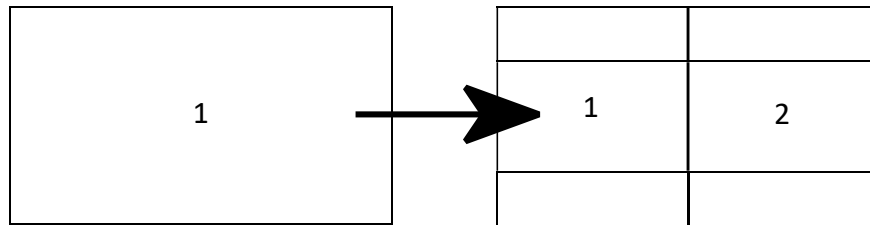

The source combinations and switching sequence for dual view is as follows:

1. If there's only one video source connected to the HT-RANGER2, the video source will be displayed in full screen mode.
2. When a second video source is connected, the HT-RANGER2 automatically changes to the dual view layout so that the two video sources can be displayed on the screen simultaneously.
3. If two wireless video sources are being displayed in dual view and a third video source is connected the latest connected video input source will replace the source that has been connected longer to the HT-RANGER2.

Note: The Dual View Display function can be disabled by API commands. For more information, see the separate HT-RANGER2 API documentation.

NETWORK MODE CONFIGURATION

The HT-RANGER2 includes two Ethernet ports for network flexibility and security, which support the following two network modes:

1. Transparent Mode (Default Setting)
In this mode, two Ethernet ports are interconnected with each other, and each one can be used for device control by connecting to the LAN where the controller resides, for BYOD communication, and for the attached device (e.g. room PC) to access the network.
2. Isolated Mode
When "Secure Ethernet Mode" on the Web UI is set to Enable, "Isolated Mode" is activated. In "Isolated Mode", the SECURE LAN port is used for controlling the device; the UTILITY LAN port is for BYOD communication and for the attached devices to access the network.

AUTOMATIC SIGNAL SWITCHING

The automatic signal switching function allows for quick and easy video switching without the need for user control. By default, the automatic signal switching function is set as enabled.

1. When there is only one video input source connected, the HT-RANGER2 will automatically output and display it on the screen.
2. When a third video input source is connected and the two video sources are being displayed in

dual view, this latest input source will replace either of the sources being displayed. For more information, see the switching mechanism in the [Dual View Display](#) section.

3. If all video sources are removed, the switcher will output the Guide Screen picture.

The HT-RANGER2 also offers the following manual methods to switch to a specific video source:

1. Using web UI.
2. Using API commands. For more information, please see the separate API documentation.

GUIDE SCREEN

The HT-RANGER2 uses a Guide Screen to convey the basic connection instructions for users. The Guide Screen can be personalized to allow custom connection instructions on the device's Web UI page. When all video sources are disconnected from the device, the following Guide Screen appears on the display screen automatically:

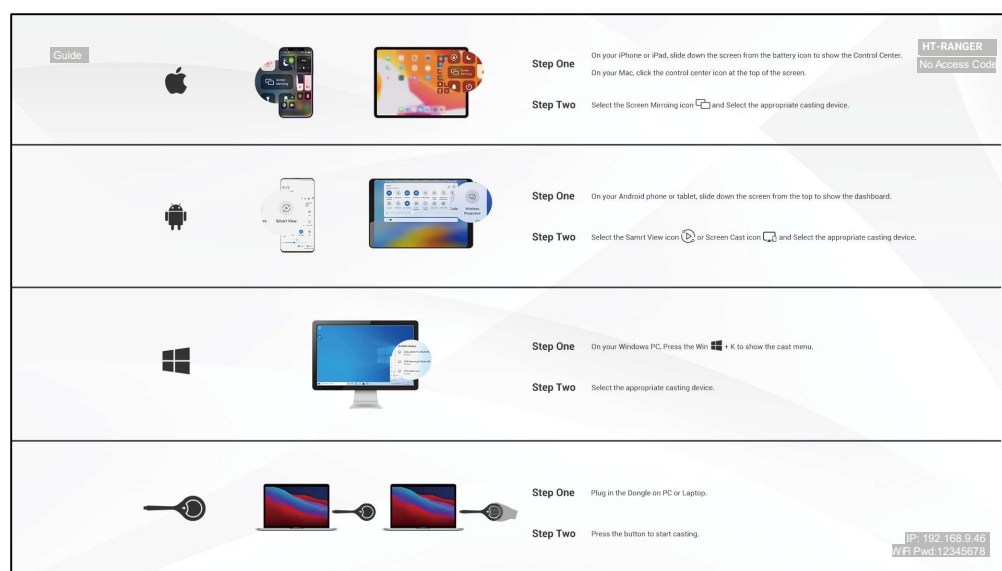

Note:

- This Guide Screen picture can be changed through the Web UI setting. Please refer to [Guide Screen](#) section for more information.
- By default, if the Guide Screen is being displayed for 60 seconds with no wireless casting connectivity, a countdown timer with the time period of 60 seconds will appear. When the timer ticks to zero, if the connected display is CEC-supported, it will enter standby mode.

The Guide Screen is accessible in the following cases:

- Automatic switching: by disconnecting all video sources from the switcher, the Guide Screen appears automatically.
- Manual switching:
 - ➔ Through Web UI page. For more information, see [State & Switch](#) section.
 - ➔ Send API command through telnet to the switcher to show the Guide Screen.

OSD

The switcher supports OSD (On Screen Display) to convey device basic information, including the video source's information, access code, device name, IP address, and Wi-Fi password. The following are two different OSD examples.

Example 1: Full screen mode



Note:

- When the HT-RANGER2 outputs the Guide Screen, the OSD will be displayed continuously until the countdown timer reaches zero.
- When the device outputs video input sources, the OSD will be displayed for 10 seconds and then will disappear.
- By default, the access code is set as blank, and therefore the OSD doesn't display the access code. If you want to set access code, please see BYOD section for more information.

Web GUI

The Web UI designed for this switcher allows for basic controls and device settings. This Web UI can be accessed through a modern browser, e.g. Chrome, Safari, Firefox, IE10+, etc.

To get access the Web UI:

1. Connect the LAN port of the switcher to a local area network. Ensure there's a DHCP server in the network so that the device can obtain a valid IP address. (If there is no DHCP server the switcher will revert to a 169.254.x.x address which you can find on the OSD. Use this to change the switcher IP to a static IP address and set your own.)
2. Connect the PC to the same network as the switcher.
3. Input the switcher's IP address in the browser and press Enter, the following window pops up. (See [OSD](#) section to easily view the IP address)

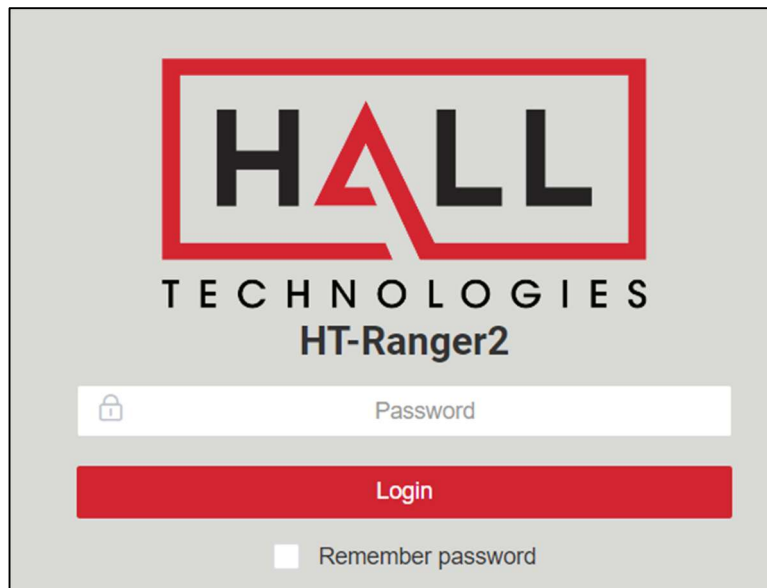

4. Input the password (default password: **admin**) and click **Login** to enter the main page.

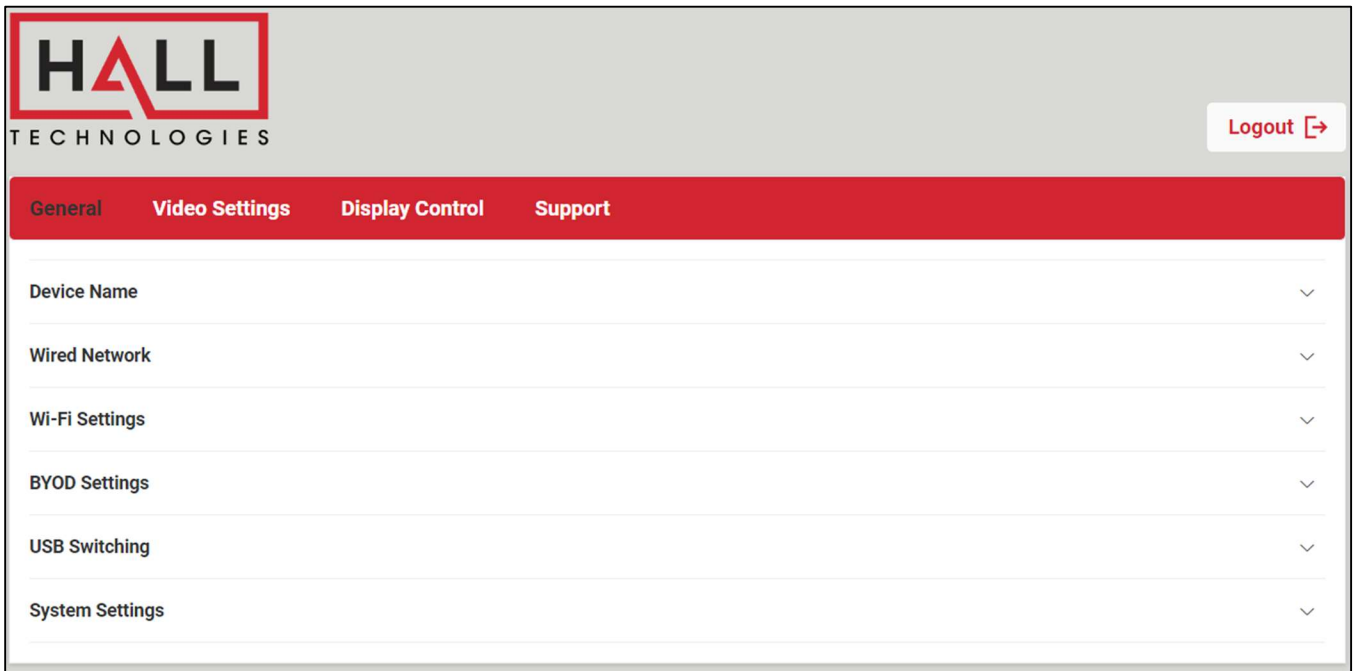

The Web UI main page includes General, Video Settings, Display Control, and Support tabs.

- **General:** offers settings of Device Name, Wired Network, Wi-Fi Settings, BYOD Settings, USB Switching, and System Settings.
- **Video Settings:** offers settings of Output Settings, State & Switch, Alias, and Video Switching.
- **Display Control:** Offers settings of CEC, RS232, Policy, and Power On/Off Device.
- **Support:** Offers Version Info and Firmware Update.

General Page

DEVICE NAME

Device Name ^

Device Name	HT-RANGER2
-------------	------------

Note: The device name must be 1~20 characters in length(letters numbers '_' or '-').

[Apply](#)

UI Element	Description
Device Name	Change the device name if desired. This name also acts as the name of soft AP and the receivers of AirPlay and Miracast. Note: The name must be 1~20 characters in length, including letters, numbers, “_” or “-”. By default, it is set as HT-RANGER2 .
Apply	Click to apply setting changes.

WIRED NETWORK

Wired Network ^

Primary (SECURE LAN) Port

IP Mode	DHCP
IP Address	10.20.0.142
Netmask	255.255.255.0
Gateway	10.20.0.1
DNS Server 1	10.20.0.1
DNS Server 2	

Note: After changing network configuration, please reopen the web page with the new network settings.

[Apply](#)

Secure Ethernet Mode	Disable
----------------------	---------

[Apply](#)

UI Element	Description
Network	Used to modify network settings.
IP Mode	Select the desired IP mode between DHCP and Static. (Default is DHCP)
IP Address	Set the IP address manually if Static mode is selected.
Netmask	Set Subnet Mask manually if Static mode is selected.
Gateway	Set gateway address manually for the device to communicate with another network that uses different communication protocols when Static mode is selected.
DNS Server 1	Set DNS server manually for the switcher to ensure normal network communication.
DNS Server 2	
Secure Ethernet Mode	<p>Enable or disable the Secure Ethernet Mode</p> <ul style="list-style-type: none"> • Enable: Select to activate Isolated Mode. In Isolated Mode, the SECURE LAN port is used to control the HT-RANGER2; the UTILITY LAN port is used for BYOD communication and network access. • Disable: Select to active Transparent Mode. In Transparent Mode, the two Ethernet ports are interconnected with each other. <p>By default, it is set to Disable.</p>
Apply	Click to apply setting changes. Note: After the IP settings are changed, please refresh the Web UI page to re-login.

WI-FI SETTINGS

Wi-Fi Settings ^

Built-in Wi-Fi

Band	5G v	
Channel	36 v	<input checked="" type="checkbox"/> Auto

Apply

Soft AP

Soft AP	Enable v	
---------	---	--

Note: Please enable soft AP to make Dongle and wireless screen casting work.

Apply

Soft AP Password	12345678	
------------------	----------	--

Note: The soft Ap password must be 8~20 characters in length(letters numbers '_' or '!').

Apply

Soft AP Router	Enable v	
----------------	---	--

Note: This feature depends on the soft AP, to use this feature, please make sure the soft AP is enabled.

Apply

UI Element	Description
Band	<ul style="list-style-type: none"> 5G: Configure the device's frequency band as 5GHz. 2.4G: Configure the device's frequency band as 2.4GHz. <p>By default, the device works at 5GHz. If your wireless devices don't support 5GHz, configures the frequency band as 2.4G before connecting them to the device via Miracast.</p>
Channel	By default, the Channel is set to Auto . If a different wireless channel is desired, uncheck Auto and select the desired channel.
Apply	Click to apply setting changes.
Soft AP	Click to enable/disable the switcher's soft AP function.
Soft AP Password	Configure soft AP password. Note: The soft AP password must be 8~20 characters in length, including letters, numbers, "_" or "!".
Soft AP Router	<ul style="list-style-type: none"> Enable: Enable the device's soft AP router function so that wireless devices connected to soft AP can access the internet (in the condition that the LAN port of the device is connected to the internet). Disable: Disable the device's soft AP function to prevent wireless devices connected to soft AP from accessing the internet. <p>Note: Before you use this feature, ensure the soft AP function is enabled.</p>

BYOD

BYOD Settings ^

BYOD Feature Enable

Access Code (0000 ~ 9999 or blank) Auto

Note: Access Code works for Airplay and Miracast (MS-MICE disabled) only.

MS-MICE Feature Disable

Note: MS-MICE (Microsoft Miracast over infrastructure connection establishment protocol) can transmit Miracast stream over the infrastructure network (existing LAN or WLAN). When MS-MICE works, access code is unsupported.

UI Element	Description
BYOD Feature	Select to enable/disable the BYOD feature. Note: This feature is available for AirPlay and Miracast, not for HT-VOYAGER2.
Access Code	Enter a four-digit access code to help prevent users from accidentally connecting to an unintended device and protect from unauthorized access. <ul style="list-style-type: none"> When an access code is configured, it appears on the upper right corner of the display. If you don't want to set access code, you can leave this blank. By default, it is set as blank.
Refresh	Click to refresh to show the latest access code.
Auto	When "Auto" is checked, the device randomly generates a four-digit access code in the following cases: <ul style="list-style-type: none"> The device switches to Guide Screen. The device reboots.
MS-MICE Feature	Select to enable/disable the MICE feature. MICE refers to the Miracast over Infrastructure Connection Establishment protocol, which is developed by Microsoft. <ul style="list-style-type: none"> Enable: Windows will only select infrastructure network when connection is through Ethernet or a secure Wi-Fi network; if not Windows will use Miracast P2P. Disable: Windows selects Miracast to wirelessly send screencasts based on the Wi-Fi peer-to-peer (P2P) connection. Default setting: Disable
Apply	Click to apply setting changes.

USB SWITCHING

USB Switching ^

USB Host Port
USB-C v
 Auto

Apply

UI Element	Description
USB Host Port	Selects the desired port to act as the host port, between USB-C, USB-B, and wireless (HT-RANGER). In Auto mode, the latest connected USB channel will be selected as the USB host automatically. By default it is set to Auto .
Apply	Click to apply setting changes.

SYSTEM SETTINGS

System Settings ^

Web Password

New Password

Confirm new password

Note: Password must be 4 to 16 characters in length, alphanumeric only.

Apply

Guide Screen

File:

Browse

Note: You must upload an image in jp(e)g format that has 1920 x 1080 pixels.

Apply

System

Reboot
Reset To Factory Default
Export Log

UI Element	Description
New Password	Set new login password.
Confirm New Password	Note: the new password must be 4 to 16 characters in length, alphanumeric only.
Guide Screen Browse	Set a new image for the Guide Screen
Apply	Click to apply the upgrade file to the device. Note: The upgrade file is a .zip archive. After the upgrade file is uploaded completely, the device reboots.

Reboot	Click to restart the switcher.
Reset to Factory Default	Click to restore the switcher to its factory defaults. You can also perform this task by using the Reset button on front panel.
Export Log	Click to export log (.tar.gz) to a local computer.

Video Settings Page

OUTPUT SETTINGS

Output Settings ^

Output timing 3840x2160p@60 Auto

Refresh Apply

Output HDCP Support Enable

Apply

UI Element	Description
Output timing	<p>Set the output resolution for HDMI Out. Two operation methods are offered.</p> <ul style="list-style-type: none"> Auto: select to output the maximum resolution supported by display based on the display's EDID. E.g. If display supports up to 4K@60Hz, the device outputs 4K@60Hz. Resolution range list: select a desired output resolution from the drop-down menu to output this fixed resolution. <p>By default, it is set as Auto.</p>
Output HDCP Support	<p>Set the HDCP capability for HDMI Out and HDBT Out.</p> <ul style="list-style-type: none"> Enable: Turn on HDCP encryption of the output. HDCP 1.4: Turn off HDCP encryption of the output. <p>By default it is set as Enable.</p>
Apply	Click to apply setting changes.

STATE & SWITCH

State & Switch ^

Output	Video Source	Timing	Format
<input type="radio"/>	USB-C IN	NoSignal	
<input type="radio"/>	HDMI IN	NoSignal	

Show Guide Screen

UI Element	Description
State & Switch	Displays the video signal status (including video source channel, video resolution and video format).
Output	Click the button (turns from white to red) to output the video source(s).
Show Guide Screen	Click the button (turns from white to red) to output the Guide Screen.
Refresh	Click to refresh the current state information.

ALIAS

Alias ^

USB-C IN	<input type="text"/>	
HDMI IN	<input type="text"/>	

UI Element	Description
Video Source	Displays the video source name.
Alias	Enter a name to change the video source name to a new one. Note: The name should be within the length of 1~20 characters including letters, numbers, underscores “_” and hyphens “-”. If you don’t want to change the name, leave it blank here.
Apply	Click to apply setting changes.

VIDEO SWITCHING

Video Switching ^

Auto Switching Enable ▾
Apply

Multiview Feature Enable ▾
Apply

Fall-back Policy Normal ▾
Apply

UI Element	Description
Auto Switching	<ul style="list-style-type: none"> • Enable: turns on auto switching, according to the Fall-back policy set. • Display: turns off auto switching.
Multiview Feature	<ul style="list-style-type: none"> • Enable: allows two sources to be displayed side-by-side. These sources can be any combination of USB-C, HDMI, and two wireless casting devices and are selected in video switching. • Display: displays one source at a time full screen.
Fall-back Policy	<ul style="list-style-type: none"> • Normal: reverts back to the last selected source. • HDMI: reverts back to the HDMI input when a source in USB-C or wireless casting is disconnected. • USBC: reverts back to the USB-C input when a source in HDMI or wireless casting is disconnected.
Apply	Click to apply setting changes.

Display Control Page

CEC

CEC

Configure

Wakeup Command	<input type="text" value="40 04"/>	example: 40 04
Standby Command	<input type="text" value="ff 36"/>	

Note: The format of CEC commands support Hex only, the limitation for longest byte is within 15.

Apply

Test

Wakeup **Standby**

UI Element	Description
Wakeup Command	Enter the CEC wakeup command for the controlled display device in hex format. (For more information about the command refer to the user guide of your display.) Default setting: 40 04
Standby Command	Enter the CEC standby command for the controlled display device in hex format. (For more information about the command refer to the user guide of your display.) Default setting: ff 36
Apply	Click to apply setting changes.
Wakeup	Click to send the Wakeup command to wake up the display from standby mode.
Standby	Click to send the Standby command to set the display into standby mode.

RS232

RS232
⤴

Configure

RS232 parameter	<input type="text" value="9600-8n1"/>	example: 115200-8n1
Wakeup Command	<input type="text"/>	
Standby Command	<input type="text"/>	
RS232 hex string enable	<input type="text" value="Enable"/>	

Test

UI Element	Description
RS232 Parameter	Set the RS232 parameters for the controlled display. (For more information about the command parameters refer to the user guide of your display.)
Wakeup Command	Enter the RS232 wakeup command for the controlled display device in hex format. (For more information about the command refer to the user guide of your display.) Default setting: (blank)
Standby Command	Enter the RS232 standby command for the controlled display device in hex format. (For more information about the command refer to the user guide of your display.) Default setting: (blank)
RS232 Hex String Enable	<ul style="list-style-type: none"> Enable: select to use the RS232 standby and wakeup commands in hex string form to control your display device. Disable: select to directly send the original standby or wakeup commands to control the attached display device. Default Setting: Enable
Wakeup	Click to send the Wakeup command to wake up the display from standby mode.
Apply	Click to apply setting changes.
Wakeup	Click to send the Wakeup command to wake up the display from standby mode.
Standby	Click to send the Standby command to set the display into standby mode.

POLICY

Policy ^

Auto Standby Disable v

Apply

Auto Standby Time (Second, ranges from 0 to 3600) 10

Sink Power Mode Both v

Apply

UI Element	Description
Auto Standby	<ul style="list-style-type: none"> Enable: when there's no valid signal input to the HT-RANGER2 during a specified period of time, the HT-RANGER2 will enter standby status automatically. Disable: turn off auto standby mode. <p>Default Setting: Enable</p>
Auto Standby Time	<p>Set the standby timeout for the HT-RANGER2</p> <ul style="list-style-type: none"> If the standby timeout doesn't exceed 60 seconds, a 60-second OSD standby countdown of the HT-RANGER2 will appear on the display screen immediately once it outputs the Guide Screen. If the standby timeout is larger than 60 seconds, a 60-second OSD standby countdown will appear on the display when timeout has only 60 seconds left. If Auto Standby Time is set to 0, the HT-RANGER2 will enter standby mode immediately once it outputs the Guide Screen <p>Default Setting: 120</p>
Sink Mode Power	<ul style="list-style-type: none"> Both: enable both CEC and RS232 mode to manage the sink power. CEC: enable CEC to manage the sink power. RS232: enable RS232 to manage the sink power. <p>Default Setting: Both</p>
Apply	Click to apply setting changes.

POWER ON/OFF DEVICE

Power On/Off Device



Power On Power Off

UI Element	Description
Power On	Click to wake the HT-RANGER2 up from standby mode.
Power Off	Click to set the HT-RANGER2 into standby mode.

Support Page

VERSION INFO

Version Info ^

Version	V1.1.1
Build Time	2024.09.26 08:03:24

UI Element	Description
Version	Displays the switcher's firmware version.
Build Time	Shows the time and date when the switcher's firmware was built.

FIRMWARE UPDATE

Firmware Update ^

File: Browse

Note: The legal firmware package is a .zip archive. The system will be rebooted to finish upgrading.

Apply

UI Element	Description
Browse	Browse for the latest firmware file and select it.
Apply	Loads the firmware to the HT-RANGER2.

Firmware Upgrade

The switcher supports a firmware upgrade using the Web UI and through the USB-A port on rear panel. To upgrade the firmware through the Web UI, see Firmware section.

To upgrade the firmware through the USB-A port on rear panel, perform the following:

1. Name the upgrade file package “HT-RANGER2-update.zip”.
2. Create a new folder named “upgrade” under the root directory of a FAT32 or NTFS USB Drive. Place the upgrade file in this folder.
3. Connect the USB Drive to either of the switcher’s USB-A ports. It will take about 1 minute for the switcher to read the USB Drive. If the switcher detects the upgrade file is a newer version, it will start to upgrade automatically. When the upgrade process is complete, the switcher will reboot.

Note:

- Before connecting USB Drive to the switcher, we recommend that you remove the USB-C source from the switcher’s USB-C port.
- Do not disconnect power to the HT-RANGER during the upgrade process.
- If the switcher detects the upgrade file is not a newer version, it will not start the upgrade.

Troubleshooting

Problem Type	Problem	Options
Video	No Video on Display	<p>Confirm the HDMI input on the display is correctly selected</p> <p>Confirm the connected source is sending video to the HT-RANGER2 (verify the connected laptop is in duplicate or extend mode)</p>
	Choppy video using AirPlay	Make sure the AirPlay device's WiFi is connected to HT-RANGER2's soft AP (may need to turn on in Web UI)
USB	USB-C not connecting	<p>Verify connected cable supports USB-C</p> <p>The response time to output video of USB 3.0 and Type-C is typically 6-8 seconds, although the response time between PC's can differ</p> <p>Confirm the PC can transmit video over USB-C by installing the DisplayLink device driver: https://www.displaylink.com/downloads</p>
	PC charge reminder pop-up	<p>This pop-up is normal since the HT-RANGER2 charging power might be different than what the laptop requires</p> <p>To ensure the laptop doesn't lose power, connect a dedicated power supply</p>
Audio	No audio at far end on soft codec call (i.e. Meet, Teams, Zoom, etc.)	<p>Verify the HT-RANGER2 microphone is not muted (red LED means muted)</p> <p>Verify the microphone selected in the soft codec is the HT-RANGER2</p> <p>Verify the soft codec microphone is not muted</p>
	No audio heard on the display	<p>Verify the HT-RANGER2 is selected as the desired speaker output in the laptop by clicking on the speaker icon to open the audio output</p> <p>Verify the display is not muted</p> <p>Verify the levels are turned up on both the laptop and the HT-RANGER2</p>

Specifications

Video	
Rear Interface Ports	<p>1 x USB Type-C Female Input: Up to 3840x2160 @30Hz USB to Ethernet bridge for network connection USB-C charger up to 60W (20V, 3A) USB3.0 Host</p> <p>1 x HDMI Type-A Female Input: Video input up to 3840x2160 @30Hz</p> <p>1 x USB 3.0 Type-B Female Host Port: Standalone USB host port</p> <p>1 x RJ45 Female Connector HDBT Out: Mirror of HDMI output Supported HDBT with HT-DSCV-70-RX</p> <p>2 x RJ45 Female Connectors LAN Ports: 10/100/1000Mbps Ethernet Divided into 2 VLANs for network security</p> <p>4 x SMA Connectors: WiFi Antenna connections</p> <p>1 x 5.5/2.1 DC Screw Connector: DC 20V power supply</p>
Front Interface Ports	<p>3 x USB 3.0 Type-A Connectors: Connection to USB peripherals Up to 1A each</p> <p>1 x 5-pin 3.5mm Phoenix Male Connector: Analog audio output Balanced 2-channel</p> <p>1 x 3-pin 3.5mm Phoenix Male Connector: RS-232 for external control</p> <p>1 x USB Type-C Female Connector: Pairing to HT-VOYAGER2</p>
Input Resolutions	<p>HDMI/USB-C (8-bit, YUV 4:4:4 / 4:2:2 or RGB, up to HDCP 1.4) 640x480⁸ 800x600⁸ 1024x768⁸ 1280x768⁸ 1280x800⁸ 1280x1024⁸ 1366x768⁸ 1366x768⁸ 1440x900⁸ 1400x1050⁸ 1600x1200⁸ 1680x1050⁸ 1920x1200⁸ 720x480⁸ 720x576⁶ 1280x720^{5,6,8} 1920x1080^{2,3,5,6,8} 3840x2160⁵</p> <p>Miracast (Wi-Fi) 640x480⁸ 720x480⁸ 720x576⁶ 1280x720^{2,3,5,6,8} 1920x1080^{2,3,5,6,8}</p> <p>Airplay Mirroring (LAN/Wi-Fi) Max 1920x1080⁸</p> <p>ChromeCast Mirroring (LAN/Wi-Fi) Max 1920x1080⁵</p> <p>HT-VOYAGER2 USB Dongle 1920x1080⁸ 3840x2160⁵</p> <p>1 = at 23.98 Hz, 2 = at 24 Hz, 3 = at 25 Hz, 4 = at 29.97 Hz, 5 = at 30Hz, 6 = at 50 Hz, 7 = at 59.94 Hz, 8 = 60 Hz</p>
Output Resolutions	<p>HDMI/USB-C (8-bit, YUV 4:4:4 / 4:2:2 or RGB, up to HDCP 2.2) 640x480⁸ 800x600⁸ 1024x768⁸ 1280x768⁸ 1280x800⁸ 1280x1024⁸ 1366x768⁸ 1440x900⁸ 1600x1200⁸ 1680x1050⁸ 1920x1200⁸ 1920x2160⁵ 2560x1440^{5,8} 2560x1600⁸ 720x480⁸ 720x576⁶ 1280x720^{6,8} 1920x1080^{2,3,5,6,8} 3840x2160^{3,5,6,8}</p> <p>HDBT Out (8-bit, YUV 4:4:4 / 4:2:0* or RGB, up to HDCP 1.4) 640x480⁸ 800x600⁸ 1024x768⁸ 1280x800⁸ 1280x1024⁸ 1366x768⁸ 1440x900⁸ 1600x1200⁸ 1680x1050⁸ 1920x1200⁸ 720x480⁸ 720x576⁶ 1280x720^{6,8} 1920x1080^{2,3,5,6,8} 3840x2160^{3,5,6,8*}</p> <p>1 = at 23.98 Hz, 2 = at 24 Hz, 3 = at 25 Hz, 4 = at 29.97 Hz, 5 = at 30Hz, 6 = at 50 Hz, 7 = at 59.94 Hz, 8 = 60 Hz</p>

Audio	
Input Audio Port	1 x HDMI; 1 x USB-C In; 1 x LAN; 1 x Wi-Fi
Input Audio Signal	RAW PCM 2.0, 16 bit, 32/44.1/48KHz sps
Output Audio Port	1 x HDMI
Output Audio Signal	RAW PCM 2.0, 16 bit, 32/44.1/48KHz

Wi-Fi	
Standard	IEEE 802.11 a/b/g/n/ac
Frequency	Dual bands, 2.4~2.4835GHz, 5.0~5.8GH
Throughput	2T x 2R, up to 867Mbps
Security	WEP, TKIP, AES, WPA, WPA2

Control	
Control Connector	2 x RJ45, 10/100/1000Mbps Ethernet
Control Method	LAN (Web UI & Telnet API)

General	
Operating Temperature	0 to + 45°C (32 to + 113°F)
Storage Temperature	-20 to +70°C (-4 to + 158°F)
Humidity	10% to 90%, non-condensing
ESD Protection	Human-body Model: ±8kV (Air-gap discharge)/ ±4kV (Contact discharge)
Power Supply	12V 2A DC
Power Consumption	12W (Max)
Device Dimension (WxHx D)	8.46" x 0.98" x 6.29" (215mm x 25mm x 160 mm)
Net Weight	1.75lbs. (0.79kg)



© Copyright 2022. Hall Technologies
All rights reserved.

1234 Lakeshore Drive Suite #150, Coppell, TX 75019
halltechav.com / support@halltechav.com
(714)641-6607