

ProHD

MULTI FORMAT LCD MONITOR

DT-N17F



INSTRUCTIONS



For Customer Use:

Please read the Instruction Manual carefully and retain this information for future reference.

Safety Precautions

| | |
|---|---|
|  CAUTION RISK OF ELECTRICAL SHOCK DO NOT OPEN  | <p>The lightning flash with arrowhead symbol, within an equilateral triangle is intended to alert the user to the presence of uninsulated "dangerous voltage" within the product's enclosure that may be of sufficient magnitude to constitute a risk of electric shock to persons.</p> |
| <p>CAUTION: To reduce the risk of electric shock. Do not remove cover (or back). No user serviceable parts inside. Refer servicing to qualified service personnel.</p> | <p>The exclamation point within an equilateral triangle is intended to alert the user to the presence of important operating and maintenance (servicing) instructions in the literature accompanying the appliance.</p> |

WARNING: TO REDUCE RISK OF FIRE OR ELECTRIC SHOCK, DO NOT EXPOSE THIS APPARATUS TO RAIN OR MOISTURE. NO OBJECTS FILLED WITH LIQUIDS, SUCH AS VASES, SHALL BE PLACED ON THE APPARATUS.

Warning: This is a class A product. In a domestic environment this product may cause radio interference in which case the user may be required to take adequate measures.

IMPORTANT SAFEGUARDS

Electrical energy can perform many useful functions. This unit has been engineered and manufactured to assure your personal safety. But **IMPROPER USE CAN RESULT IN POTENTIAL ELECTRIC SHOCK OR FIRE**. In order not to defeat the safeguards incorporated into this product, observe the following basic rules for its installation, use, and service. Please read these "IMPORTANT SAFEGUARDS" carefully before use.

- All the safety and operating instructions should be read before the product is operated.
- The safety and operating instructions should be retained for future reference.
- All warnings on the product and in the operating instructions should be adhered to.
- All operating instructions should be followed.

POWER CONNECTION

The power supply voltage rating of this product is AC 120 V (For U.S.A. and Canada) and AC 220 -240 V (For Europe and Asia).

The power cord attached conforms to the following power supply voltage and countries. Use only the power cord designated to ensure safety and EMC regulations of each country.

Not all types of power cords are supplied to this product.

For U.S.A. and Canada: AC 120V For Europe and Asia: AC 220-240V



This plug will fit only into a grounded power outlet. If you are unable to insert the plug into the outlet, contact your electrician to install the proper outlet. Do not defeat the safety purpose of the grounded plug.

This product should be operated only with the type of power source indicated on the label. If you are not sure of the type of power supply of your home, consult your product dealer or local electric power company.

- Before connecting other products such as VCR's and personal computers, you should turn off the power of this product for protection against electric shock.
- Do not use attachments not recommended by the manufacturer as they may be hazardous.
- **When replacement parts are required**, be sure the service technician has used replacement parts specified by the manufacturer or equivalents. Unauthorized substitutions may result in fire, electric shock, or other hazards.
- **Upon completion of any service or repairs to this product**, ask the service technician to perform safety checks to determine that the product is in proper operating condition.

- Do not install this product in the following places:
 - in a damp or dusty room
 - where the product is exposed to soot or steam, such as near the cooking counter or a humidifier
 - near heat sources
 - where condensation easily occurs, such as near the window
 - in a location exposed to direct sunlight or strong light
- Do not place this product on an unstable cart, stand, or table. The product may fall, causing serious injury to a child or adult, and serious damage to the product. The product should be mounted according to the manufacturer's instructions, and should use a mount recommended by the manufacturer.
- Do not use this product near water.
- Be sure to install the product in the place where proper temperature and humidity are kept (☞ "Operating conditions" on page 19). This product becomes hot during its use. Take enough care when handling the product.

Under the following conditions,

1. Turn off the power.
2. Unplug this product from the wall outlet.
3. Refer service to qualified service personnel.
 - a) When the product emits smoke or unusual smell.
 - b) When the product exhibits a distinct change in performance —for example, no picture or no sound.
 - c) If liquid has been spilled, or objects have fallen on the product.
 - d) If the product has been exposed to rain or water.
 - e) If the product has been dropped or damaged in any way.
 - f) When the power supply cord or plug is damaged.

Safety Precautions (cont.)

Do not attempt to service this product yourself, as opening or removing covers may expose you to dangerous voltages and other hazards. Refer all service to qualified service personnel.

Do not use the product for a long time if the sound is distorted.

Use only the power source specified on the unit.

- AC power: 120 V/220 - 240V, 50 Hz/60 Hz
- DC power: 11V-17V

- When the product is left unattended and unused for a long period of time, unplug it from the wall outlet and disconnect the cable system.
- Do not overload wall outlets, extension cords, or convenience receptacles on other equipment as this can result in a risk of fire or electric shock.

- Slots and openings in the cabinet are provided for ventilation. These ensure reliable operation of the product and protect it from overheating. These openings must not be blocked or covered.
- Never push objects of any kind into this product through openings as they may touch dangerous voltage points or short-circuit the parts, which could result in a fire or electric shock.
- Never spill liquid of any kind on the product.
- Never place anything on the product. (Placing liquids, naked flames, cloths, paper, etc. on the product may cause a fire.)
- Do not apply any strong shock to the LCD panel. (Do not hit any object against it or push it with a sharp-pointed tool.)
- Do not put heavy objects on the product.
- Do not step on or hang on the product.

Safety Precautions (cont.)

IMPORTANT SAFETY INSTRUCTIONS

- 1) Read these instructions.
- 2) Keep these instructions.
- 3) Heed all warnings.
- 4) Follow all instructions.
- 5) Do not use this apparatus near water.
- 6) Clean only with dry cloth.
- 7) Do not block any ventilation openings. Install in accordance with the manufacturer's instructions.
- 8) Do not install near any heat sources such as radiators, heat registers, stoves, or other apparatus (including amplifiers) that produce heat.
- 9) Do not defeat the safety purpose of the polarized or grounding-type plug. A polarized plug has two blades with one wider than the other. A grounding type plug has two blades and a third grounding prong. The wide blade or the third prong are provided for your safety. If the provided plug does not fit into your outlet, consult an electrician for replacement of the obsolete outlet.
- 10) Protect the power cord from being walked on or pinched particularly at plugs, convenience receptacles, and the point where they exit from the apparatus.
- 11) Only use attachments/accessories specified by the manufacturer.
- 12) Use only with the cart, stand, tripod, bracket, or table specified by the manufacturer, or sold with the apparatus. When a cart is used, use caution when moving the cart/apparatus combination to avoid injury from tip-over.
- 13) Unplug this apparatus during lightning storms or when unused for long periods of time.
- 14) Refer all servicing to qualified service personnel. Servicing is required when the apparatus has been damaged in any way, such as power-supply cord or plug is damaged, liquid has been spilled or objects have fallen into the apparatus, the apparatus has been exposed to rain or moisture, does not operate normally, or has been dropped.
- 15) Apparatus shall not be exposed to dripping or splashing and no objects filled with liquids, such as vases, shall be placed on the apparatus.
- 16) Batteries shall not be exposed to excessive heat such as sunshine, fire or the like.
- 17) When discarding batteries, environmental problems must be considered and the local rules or laws governing the disposal of these batteries must be followed strictly.



Operating Precautions

The LCD panel and backlight have life expectancy. Due to the basic characteristics of the LCD panel, an afterimage or uneven display may occur. It is recommended that you change images occasionally, activate the power saving function, or often turn off the power to reduce the load on the LCD panel. Continuous operations of the LCD panel may accelerate the deterioration.

● Maintenance

Unplug this product from the wall outlet before cleaning.

LCD panel

To avoid irreparable change in appearance of the screen such as uneven color, discoloration, scratches, be careful about the following:

- Do not paste or stick anything using any glues or adhesive tapes.
- Do not write anything on the screen.
- Do not strike the screen with a hard object.
- Avoid condensation on the screen.
- Do not wipe the screen with any liquid such as water. In addition, wiping the screen with water-diluted neutral detergent or solvent such as alcohol, thinner, or benzine may affect the anti-reflection treatment of the screen.
- Do not wipe the screen forcefully.

Wipe stains off the LCD panel with a soft cloth. If the screen gets heavily stained, wipe it with a soft cloth soaked in water-diluted neutral detergent and wrung well, then wipe with a soft dry cloth.

Cabinet

To avoid the deterioration or damages of the cabinet such as its paint's peeling away, be careful about the following:

- Do not wipe the cabinet using solvent such as alcohol, thinner, or benzine.
- Do not expose the cabinet to any volatile substance such as insecticides.
- Do not allow any rubber or plastic in contact for a long time.
- Do not wipe the cabinet forcefully.

Wipe stains off the cabinet with a soft cloth. If the cabinet gets heavily stained, wipe it with a soft cloth soaked in water-diluted neutral detergent and wrung well, then wipe with a soft dry cloth.

Ventilation openings

Use a vacuum cleaner to get rid of the dust around the intakes (all the openings). If a vacuum cleaner is not available, use a cloth and wipe it off. Leaving the dust around the intakes may prevent proper temperature control and cause damage to the product.

Table of Contents

| | |
|--|----|
| Safety Precautions | 2 |
| IMPORTANT SAFEGUARDS | 2 |
| Operating Precautions | 4 |
| Caution for use of the product in the high temperature | 4 |
| Maintenance | 4 |
| Installation | 6 |
| Index of Parts and Functions | 7 |
| Rear panel | 7 |
| Front panel | 8 |
| Showing Input Signals | 9 |
| Volume Adjustment/Audio Channel Selection | 9 |
| On the Information Display | 9 |
| On the Status Display | 9 |
| Menu Configuration | 10 |
| The operation procedure | 10 |
| Menu Transition Diagram | 10 |
| Main Menu | 11 |
| External Control | 18 |
| About the external control | 18 |
| Using the UMD control | 18 |
| Using the GPI control | 18 |
| Troubleshooting | 19 |
| Specifications | 20 |
| General | 20 |
| LCD panel | 20 |
| Input/output terminals | 20 |
| Dimensions | 21 |
| Available signals | 22 |

Installation

- Do not rest your arm on the monitor or lean against the monitor.
- Do not touch the LCD panel when installing the monitor.
- Be sure to install the monitor securely to prevent the monitor from falling over, which may cause damage to the monitor or injury.

● **To install the monitor on a shelf or any other suitable surface using screws**

- 1 Lay the monitor on a cloth with the LCD panel facing down to prevent the LCD panel from being damaged.**
- 2 Take out the desktop stand (2 feet) from accessory box in the package.**
- 3 Clockwise screw the feet onto the bottom of the monitor.**

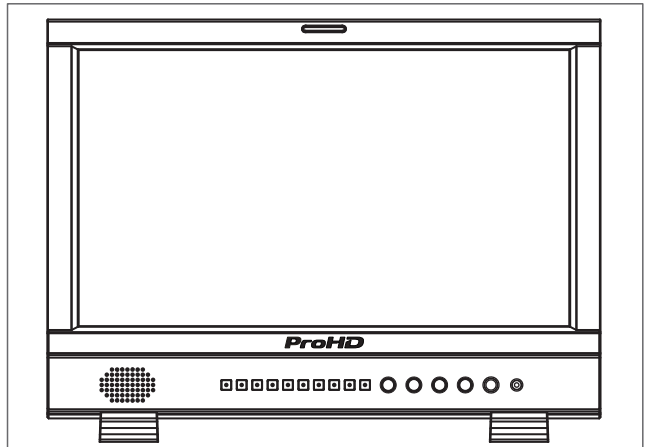
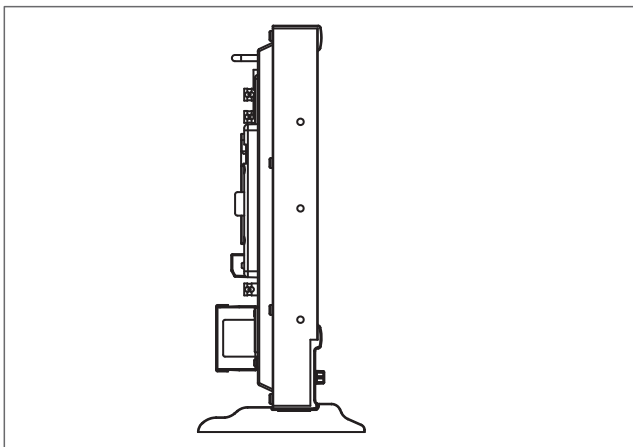
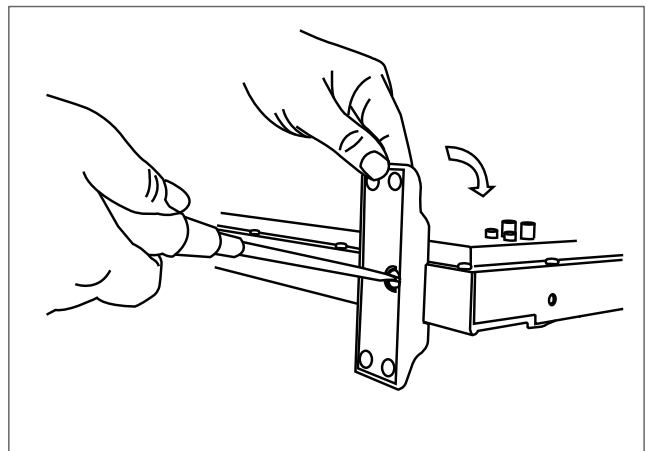
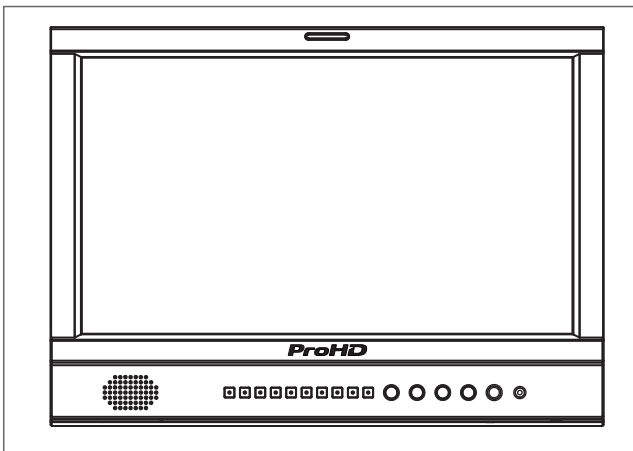

Index of Parts and Functionos

Rear panel

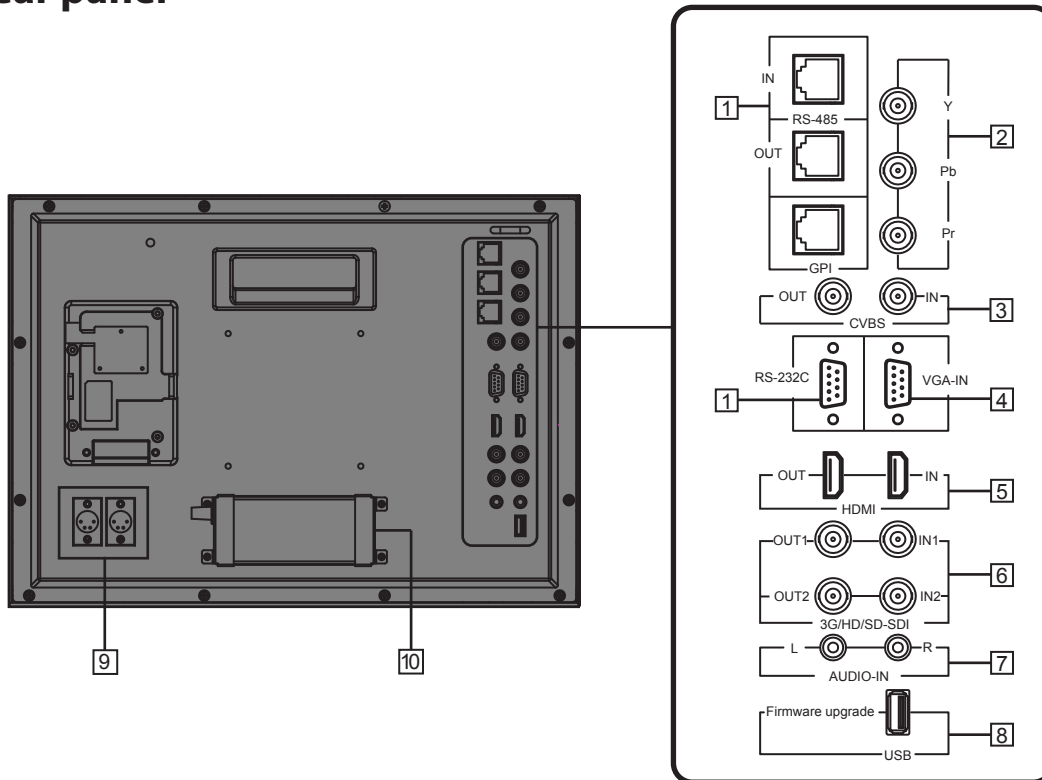

- 1 **REMOTE terminal**
Terminal for controlling the monitor by an external control (☞ “External Control” on page 18).
- 2 **Y / Pb / Pr (IN) terminals (BNC)**
- 3 **CVBS terminals (BNC)**
Input (IN) and output (OUT) terminals for the composite signals.
- 4 **VGA-IN (mini D-sub 15pin)**
Input terminal for analog RGB signal. (☞ page 23)
- 5 **HDMI terminal**
Input / Output terminal for HDMI signals. The monitor will not display or output HDMI with HDCP protection. (☞ page 23)
- 6 **E. AUDIO 3G/HD/SD SDI (IN 1, IN 2) terminals (BNC)**
Input / Output terminals for the HD/SD SDI signals.
 - The terminals accept also EMBEDDED AUDIO signals including up to 16 audio channels with a sampling frequency of 48 kHz.
- 7 **AUDIO (IN) terminals (pin jack)**
Input terminals for the analog audio signals.
 - Set signal source as ANALOG (CVBS, VGA, YPbPr) ,the analog audio can be monitored as audio meters or output via Speaker/Headphone.
- 8 **USB socket**
Download new firmware to a USB stick, and insert into this socket. By menu operating, the monitor firmware can be upgraded.
- 9 **DC-IN terminal**
Main (Back up) power input, connect with DC11V -17V 4-pin XLR power adapter. (Pin 1: Negative, Pin 4: Positive)
- 10 **AC-IN terminal**
AC power input connector.
Connect the provided AC power cord to an AC outlet.

CAUTION

Do not connect the power cord until all other connections are completed.

Note for connections

- Before making any connections, turn off all the equipment.
- Use a cord whose plugs correctly match the terminals on this monitor and the equipment.
- Plugs should be firmly inserted; poor connections could cause noise.
- When unplugging a cord, be sure to grasp its plug and pull it out.
- DO NOT connect the power cord until all connections are complete.
- Refer also to the user manual of each piece of equipment.

Index of Parts and Functions (cont.)

Front panel

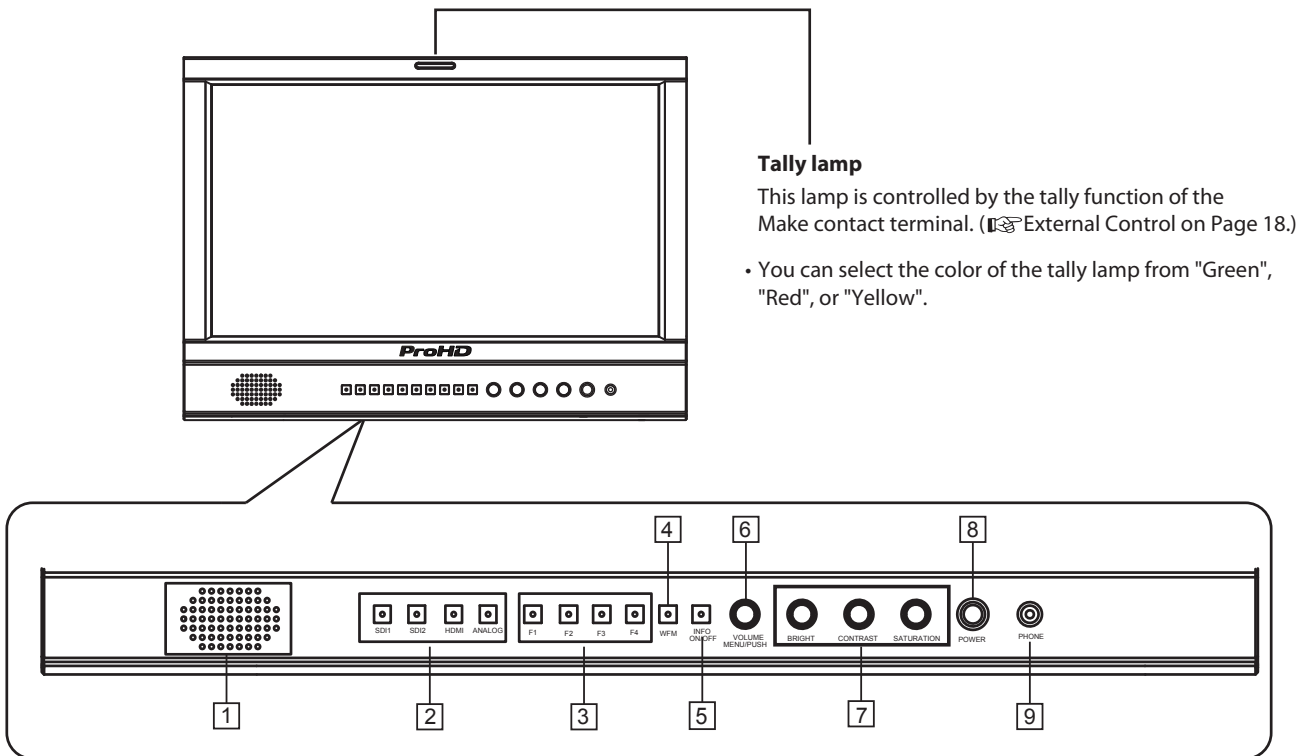

Tally lamp
 This lamp is controlled by the tally function of the Make contact terminal. (External Control on Page 18.)

- You can select the color of the tally lamp from "Green", "Red", or "Yellow".

- 1 **Speaker:**
 For SDI/HDMI embedded audio and analog audio monitoring. (Will not work if earphone is plugged in)
- 2 **INPUT SELECT buttons/lamps**
 Selects an input.
 SDI 1: E. AUDIO 3G/HD/SD SDI (IN 1) terminal
 SDI 2: E. AUDIO 3G/HD/SD SDI (IN 2) terminal
 HDMI:HDMI terminal
 ANALOG: select from CVBS, VGA, Y/ Pb / Pr signal
 ●The lamp for the selected input lights
- 3 **FUNCTION button**
 You can use the functions assigned to this button.
- 4 **WFM button**
 Waveform shortcut key, press "WFM" to quickly turn on or turn off the waveform, and select the type of the waveform.
- 5 **DISP button**
 Press "INFO ON/OFF" to turn on or turn off relevant status information, audio and video waveform.
- 6 **VOLUME MENU/PUSH**
 When the menu is inactivated, press "VOLUME MENU/PUSH" to turn on the main menu
 Revolve "VOLUME MENU/PUSH" to adjust settings or parameters, and press to apply
 When the menu is inactivated, revolve "VOLUME MENU/PUSH" to adjust the sound volume
- 7 **Picture adjustment knob**
 BRIGHT: Adjusts the picture brightness and the default value is 50.
 CONTRAST: Adjusts the picture contrast and the default value is 50.
 SATURATION: Adjusts the picture saturation and the default value is 50.
 * Directly press BRIGHT/CONTRAST/SATURATION knobs, the parameters will recover to default value.
- 8 **POWER**
 Turns on and off the monitor.
- 9 **PHONE**
 3.5mm earphone socket, for SDI/HDMI embedded audio and analog audio monitoring.

Showing Input Signals

Volume Adjustment

- 1 When no menu screen is not displayed, revolve the "VOLUNE MENU/PUSH" button
- 2 Clockwise revolve "VOLUME MENU/PUSH" knob to volume up, and anticlockwise revolve to volume down. The volume value range is 0-31.
- 3 Press the "VOLUME MENU/PUSH" button to finish.
The "Volume" screen disappears automatically if no operations are made for 3 seconds.

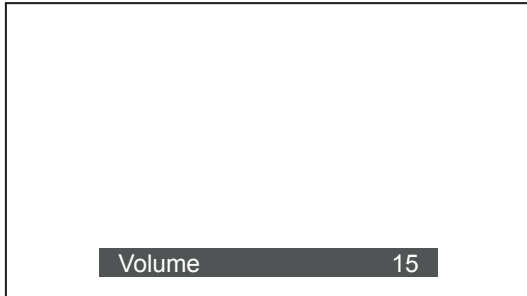

On the Information Display

1 Time code (SDI)

Under SDI input, it can display Time code. If no Time code information is detected, it will be displayed as "TC UNLOCKED". User can set function keys F1 ~ F4 or GPI pins as "Time code" to turn on or off this function.

2 UMD

Set up the UMD under "UMD" submenu.

3 AFD (SDI)

User can set function keys F1 ~ F4 or GPI pins as "AFD" to turn on or off this function. If no relevant information is detected, it will be displayed as "AFD: UNLOCKED".

4 Audio Bar

Monitor the audio information. The relevant parameters like position, audio channels and blending, etc. can be changed under "Audio Bar" submenu. User can set function Keys F1 ~ F4 or GPI pins as "Audio Bar" to turn on or off this function.

5 Histogram

User can set function Keys F1 ~ F4 or GPI pins as "Histogram" to turn on or off this function.

6 Vector

The relevant parameters like Vector position, Vector color and Vector blending, etc. can be changed under "Vector" submenu. User can set function Keys F1 ~ F4 or GPI pins as "Vector" to turn on or off this function.

7 Waveform

Press "WFM" on the front panel to turn on/of this function. The relevant parameters like WFM position, WFM color and WFM blending, etc. can be changed under "Waveform" submenu.

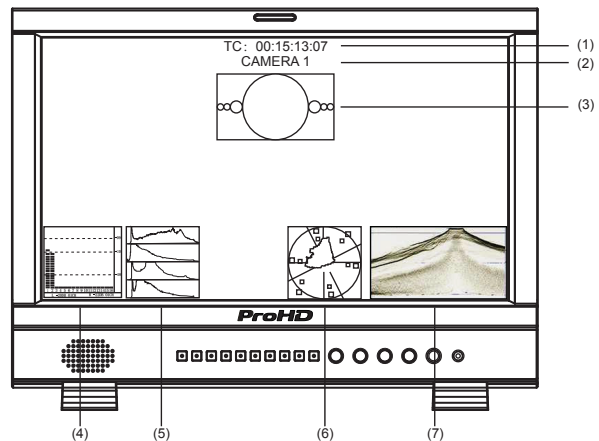

On the Status Display

Press "VOLUME MENU/PUSH" button, the main menu will pop up from the left top of the screen, to display the current working status, including:

1. Current input video format.
If no video input is locked, it will display "No Signal".
2. User profile. The monitor can restore 3 user preference settings.
3. Color temperature value.
4. Scan mode.
5. Freeze Frame mode status.
6. Odd/Even Frame mode status.
Not available if the current input signal doesn't support Odd/Even mode.
7. The Function Key 1 setting.
8. The Function Key 2 setting.
9. The Function Key 3 setting.
10. The Function Key 4 setting.
11. Current firmware version.

| Main Menu | Status | |
|---------------------|----------------|--------|
| Exit&Status > | HDMI | XXX 1 |
| Picture > | User Profile | XX 2 |
| Color Temp > | Color Temp | XXXX 3 |
| Function Key > | Scan Mode | XXX 4 |
| GPI > | Freeze Frame | XXX 5 |
| UMD > | Odd/Even Frame | XXX 6 |
| Marker > | F1 | XXX 7 |
| Audio > | F2 | XXX 8 |
| Vector > | F3 | XXX 9 |
| Waveform > | F4 | XXX 10 |
| Display > | F5 | XXX |
| System > | System Version | XXX 11 |
| Color Measurement > | | |
| OSD > | | |
| Key Inhibit > | | |

Menu Configuration

The Operation Procedure

- 1 Press the MENU button to display the Main Menu
- 2 Revolve "VOLUME MENU/PUSH" to select submenu, the selected submenu highlights in yellow, press "VOLUME MENU/PUSH" to apply and enter into the selected submenu's items
- 3 Revolve "VOLUME MENU/PUSH" to select the item which needed to adjust, press "VOLUME MENU/PUSH", the selected item and its parameters will be highlighted in yellow.
- 4 Revolve "VOLUME MENU/PUSH" to change the selected item's parameter, press "VOLUME MENU/PUSH" to apply and save the settings.
- 5 Revolve "VOLUME MENU/PUSH" to select "Exit", press "VOLUME MENU/PUSH" to quit submenu. Select "Exit & Status" under the Main Menu and press to quit Main Menu.

Notice:

- The items in gray cannot be set up.
- If there is no operation under the set time, the menu will automatically save settings and quit.
- If the key inhibit function is turned on, except key inhibit function, all other items are in grey. Please turn off the key inhibit function to adjust the items.

Menu Transition Diagram

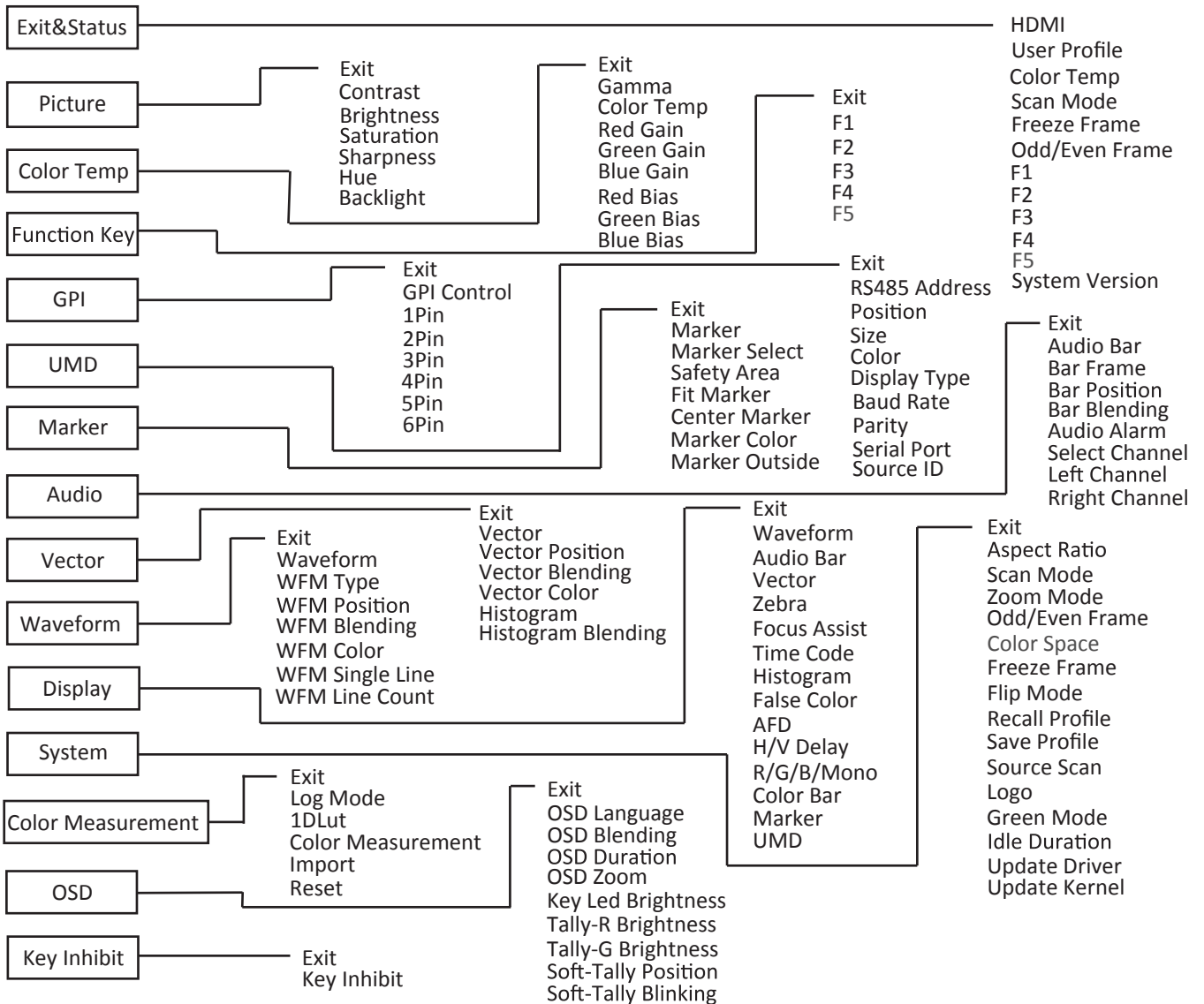

● "Exit & Status" is only displayed, and cannot be set/changed.

Menu Configuration (cont.)

Main Menu

Picture Function

Setting for the picture quality.

| Item | To do | Setting value |
|------------|--|---------------|
| Exit | Return Main Menu | |
| Contrast | Adjusts the contrast of the display. | 0 to 100 |
| Brightness | Adjusts the brightness of the display. | 0 to 100 |
| Saturation | Adjusts the saturation of the display. | 0 to 100 |
| Sharpness | Adjusts the sharpness of the display. | 0 to 100 |
| Hue | Adjusts the hue of the display. | 0 to 100 |
| Backlight | Adjusts the backlight of the display. | 0 to 100 |

Color Temperature

Adjusts the R/G/B Gain and Bias, and Gamma Preset

| Item | To do | Setting value |
|------------|------------------------------------|---|
| Exit | Return Main Menu | |
| Gamma | Select the Gamma correction value. | 2.2 (equivalent to Y 2.2) 2.4 (equivalent to Y 2.4) 2.6 (equivalent to Y 2.6) |
| Color Temp | Select the color temperature Mode. | 5600K、 6500K、 9300K、 User |
| Red Gain | Adjusts the Red Gain | 0 to 255 |
| Green Gain | Adjusts the Green Gain | 0 to 255 |
| Blue Gain | Adjusts the Blue Gain | 0 to 255 |
| Red Bias | Adjusts the Red Bias | 0 to 255 |
| Green Bias | Adjusts the Green Bias | 0 to 255 |
| Blue Bias | Adjusts the Blue Bias | 0 to 255 |

- Only "Color Temp" is set to "User", the Red/Blue/Green Gain or Red/Blue/Green Bias can be adjusted

Function Key

Set short-cut functions for F1-F4

| Item | To do | Setting value |
|------|--|--|
| Exit | Return Main Menu | |
| F1 | Assign functions to the function keys F1 - F4 on the front key board | Audio Bar, Histogram, False Color, AFD, H/V Delay, R/G/B/Mono, Marker, Color Bar, UMD, Audio Alarm, Odd/Even Frame, Focus Assist, Aspect Ratio, Scan Mode, Zoom Mode, Mute, Freeze Frame, Flip Mode, CVBS, YPbPr, VGA, Color Temp, Time Code, Zebra, Vector. |
| F2 | | |
| F3 | | |
| F4 | | |

For example: Set F3 to "R/G/B/Mono" under "Function key" submenu. User can press F3 on the front panel to adjust the parameters of "R/G/B/Mono", and the "R/G/B/Mono" will change and follow the sequence: Blue Only → Red Only → Green Only → Mono → Off.

GPI

Setting functions for external control

| Item | To do | Setting value |
|---------------|---------------------------------------|---|
| Exit | Return Main Menu | |
| GPI Control*1 | Enable GPI control | ON, OFF |
| 1 Pin | Assign functions to the GPI terminals | Red Tally, Green Tally, Yellow Tally, Aspect Ratio, Scan Mode, Zoom Mode, Mute, Freeze Frame, Flip Mode, Color Temp, Time code, Zebra, Vector, Audio Bar, Histogram, False Color, AFD, H/V Delay, R/G/B/Mono, Marker, Color Bar, UMD, Audio Alarm, Odd/Even Frame, Focus Assist |
| 2 Pin | | |
| 3 Pin | | |
| 4 Pin | | |
| 5 Pin | | |
| 6 Pin | | |

*1 When "GPI control" is set to "On", the monitor can be operated through external GPI control unit.

Example 1: Under "GPI" submenu, set "GPI control" to "On", set "2 Pin" to "Red Tally", when the pin 2 of the external GPI control unit is connected with ground, the Tally light on the front panel will turn red. When disconnected, the tally light will turn off.

Example 2: Under "GPI" submenu, set "GPI control" to "On", set "6 Pin" to "Scan Mode", when the pin 6 of the external GPI control unit is connected with ground, the Scan mode will change and follow the sequence: "Normal" → "Overscan" → "Native".

Menu Configuration (cont.)

UMD

Setting UMD control parameters (TSL UMD Protocol V3.1/4.0, provided by Television System LTD.)

| Item | To do | Setting value |
|---------------|---|-----------------------------------|
| Exit | Return Main Menu | |
| RS485 Address | Address setting 1 to 126: Set a particular address | 1 to 126 |
| Position | Position setting | Top、Bottom |
| Size | Size setting | Normal、Mid-Large、Large |
| Color | Color setting | Red、White、Black、Blue、Green、Yellow |
| Display Type | Choose Display Type | Source ID、UMD |
| Baud Rate | Baud Rate setting | 38400、9600、19200 |
| Parity | Parity setting | Even、None |
| Serial Port | Choose Serial Port | RS485、RS232 |
| Source ID | Setting of "Source ID"*1 | |

*1 Setting of "Source ID"

- (1) Change the input to one that you want to assign a video source name for.
 - (2) Select "Source ID"
 - (3) revolve the "MENU" button to select the first character.
- Each time you revolve the "MENU" button, the character changes as follows.

→ Space → 0~9 → A~Z → a~z → &()*+,-./:<>_

- (4) Press the "MENU" button to move the arrow to the next space.
 - The characters entered before moving the arrow are memorized.
- (5) Repeat steps (3) and (4) (8 characters at maximum).
- (6) Press MENU button to store the name.

● UMD setup

- (1) Connect the external control equipment with the monitor
 - (2) Set "Display Type" to "UMD"
 - (3) Set "Serial Port" to RS485 or RS232 according to the port type of external control equipment
 - (4) Make sure the "address", "Baud Rate", "Parity" the same
 - (5) Adjust the external control equipment and send UMD command, the UMD information will be display as the right photo.
- User can set the character and color of the UMD and the color of Tally1 and 2.

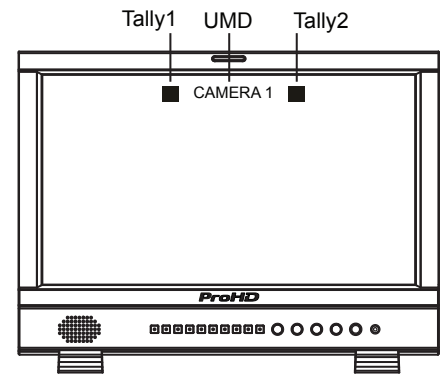

Marker

Settings for marker functions

| Item | To do | Setting value |
|----------------|--|---|
| Exit | Return Main Menu | |
| Marker | Display setting On: Displayed, Off: Not displayed | Off、On |
| Marker Select | Adjust the ratio of marker | Off、4:3、13:9、14:9、15:9、16:9、1.85:1、2.35:1 |
| Safety Area | Safety Area setting | Off、80%、85%、90%、93%、95% |
| Fit Marker*1 | Fit Marker setting | Off、On |
| Center Marker | Display setting On: Displayed, Off: Not displayed | Off、On |
| Marker Color | Marker color setting | White、Red、Green、Blue、Black、Gray |
| Marker Outside | Marker Outside color setting | Off、Gray、Black |

*1 When "Fit Marker" is Off, the size of safety area is benchmarked against the actual display screen, accounting for 80% ~ 95% of actual display screen. When "Fit Marker" is On, the size of safety area is benchmarked against the area inside the scales marker, accounting for 80% ~ 95% of the area inside the scales marker.

Example:

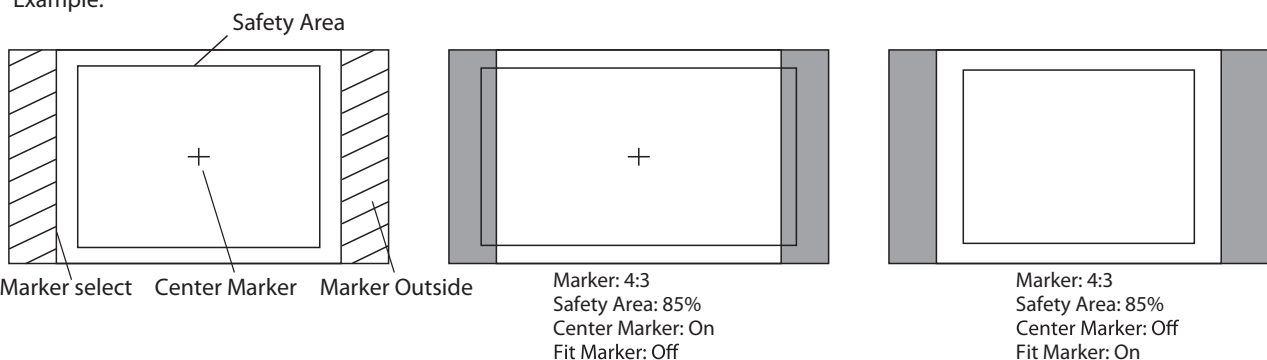

Menu Configuration (cont.)

Audio Setting

Setting for the audio meters and channel selection

| Item | To do | Setting value |
|---------------------------------|---|---|
| Exit | Return Main Menu | |
| Audio Bar | Display setting On: Displayed, Off: Not displayed | On、Off |
| Bar Frame*1 | Display setting On: Displayed, Off: Not displayed | On、Off |
| Bar Position | Bar Position setting | Top Right、Bottom Left、 Bottom Right、Top Left |
| Bar Blending | Bar Blending setting Off: Set the background of the bar display black . Low: Set the background of the bar display gray High: Set the background of the bar display transparent. | Low、Off、High |
| Audio Alarm*2 | Display setting On: Displayed, Off: Not displayed | Off、On |
| Select Channel*3 | Select Channel setting | HDMI : Channel 1-2、 1-8 SDI : Channel 1-2、 1-8、 1-16 ANALOG : Channel 1-2 |
| Left Channel Right Channel*4 | Select the audio left and right channels to output. The current left channel number displays green, and the right channel number displays red. | HDMI : Channel 1-8 SDI : Channel 1-16 |

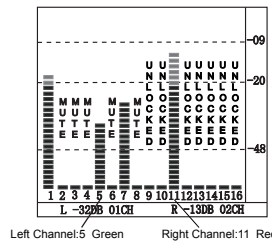
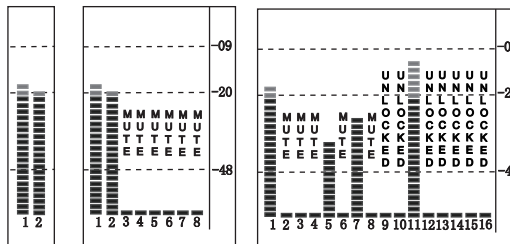
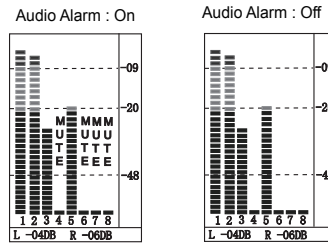
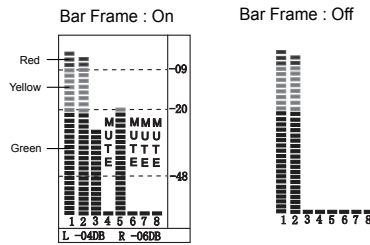

*1 When "Bar Frame" is set to "Off", only the audio meter will be displayed

When "Bar Frame" is set to "On", frame and real-time audio value will be displayed.

*2 When "Audio Alarm" is set to "On", if no embedded audio is detected, the audio bar will display "UNLOCKED". If the audio value is too low, the audio bar will display "MUTE".

*3 Select Channel

Under analog signal, only channel1-2 can be displayed.

Under HDMI signal, channel1-2 and 1-8 can be selected.

Under SDI signal, channel 1-2, 1-8 and 1-16 can be selected

*4 Audio channels can be selected to output according to the requirements.

When the current "Select Channel" is set to "Channel1-2", the left channel and right channel output can be selected from Channel1 or channel2.

When the current "Select Channel" is set to "Channel1-8", the left channel and right channel output can be selected from Channel1 to channel8.

When the current "Select Channel" is set to "Channel1-16", the left channel and right channel output can be selected from Channel1 to channel16.

In audio bar, the left channel information will be in green, and the right channel information will be in red.

Menu Configuration (cont.)

Vector

Setting for Vector scope and Histogram patterns

| Item | To do | Setting value |
|--------------------|---|---|
| Exit | Return Main Menu | |
| Vector | Display setting On: Displayed, Off: Not displayed | Off、 On |
| Vector Position | Vector Position setting | Bottom Right、 Center、 Top Left、 Top Right、 Bottom Left |
| Vector Blending | Vector Blending setting Off: Set the background of the vector display black . Low: Set the background of the vector display gray High: Set the background of the vector display transparent. | Off、 Low、 High |
| Vector Color | Vector Color setting | Color、 White、 Green、 False Color |
| Histogram | Display setting On: Displayed, Off: Not displayed | Off、 On |
| Histogram Blending | Histogram Blending setting Off: Set the background of the histogram display black . Low: Set the background of the histogram display gray High: Set the background of the histogram display transparent. | Off、 Low、 High |

Waveform

Setting for Waveform patterns

| Item | To do | Setting value |
|-----------------|--|---|
| Exit | Return Main Menu | |
| Waveform | Display setting On: Displayed, Off: Not displayed | Off、 On |
| WFM Type | Waveform type setting | Y、 Cb、 Cr、 R、 G、 B |
| WFM Position | Waveform position setting Waveform blending setting | Bottom Left、 Bottom Right、 Center、 Top Left、 Top Right |
| WFM Blending | Off: Set the background of the waveform display black . Low: Set the background of the waveform display gray High: Set the background of the waveform display transparent. | Low、 High、 Off |
| WFM Color | Waveform color setting | White、 Green、 False Color |
| WFM Single Line | Display setting On: Displayed, Off: Not displayed | Off、 On |
| WFM Line Count | WFM Line Count setting | 0 to 1079 |

*1: Only the "WFM Single Line" is set to "ON", the "WFM Line Count" can be adjusted.

"WFM Single Line" is to display the selected line waveform of "WFM Line Count"

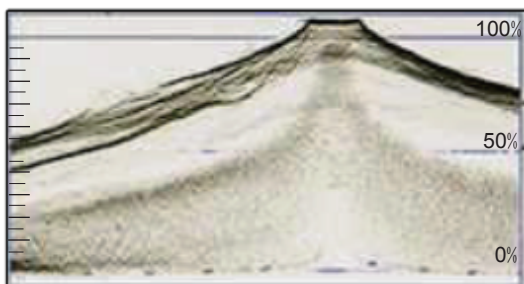

WFM Single Line: Off

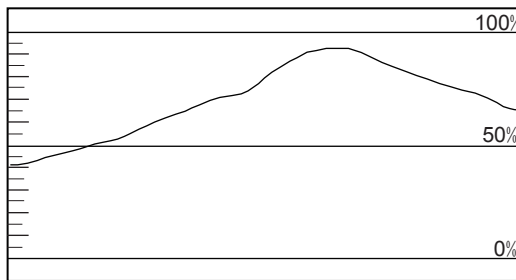

WFM Single Line: On

Menu Configuration (cont.)

Display

On/off control center for all function patterns display

| Item | To do | Setting value |
|--------------|--|--|
| Exit | Return Main Menu | |
| Waveform | Display setting On: Displayed, Off: Not displayed | Off、 On |
| Audio Bar | Display setting On: Displayed, Off: Not displayed | Off、 On |
| Vector | Display setting On: Displayed, Off: Not displayed | Off、 On |
| Zebra | Display setting On: Displayed, Off: Not displayed | Off、 On |
| Focus Assist | Focus Assist setting | Off、 Blue、 Red |
| Time Code | Display setting On: Displayed, Off: Not displayed | Off、 On |
| Histogram | Display setting On: Displayed, Off: Not displayed | Off、 On |
| False Color | Display setting On: Displayed, Off: Not displayed | Off、 On |
| AFD | Display setting On: Displayed, Off: Not displayed | Off、 On |
| H/V Delay | Display setting On: Displayed, Off: Not displayed | Off、 On |
| R/G/B/Mono | R/G/B/Mono setting | Off、 Blue Only、 Red Only、 Green Only、 Mono |
| Color Bar | Display setting On: Displayed, Off: Not displayed | Off、 On |
| Marker | Display setting On: Displayed, Off: Not displayed | Off、 On |
| UMD | Display setting On: Displayed, Off: Not displayed | Off、 On |

System

General system mode settings and firmware upgrade

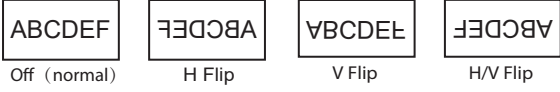
| Item | To do | Setting value |
|-----------------|--|--|
| Exit | Return Main Menu | |
| Aspect Ratio | Aspect Ratio setting | 16:9、 4:3 |
| Scan Mode | Scan Mode setting | Normal、 OverScan、 Native |
| Zoom Mode | Zoom Mode setting | Off、 Zoom1、 Zoom2 |
| Odd/Even Frame | Odd/Even Mode setting | Off、 Odd Mode、 Even Mode |
| Freeze Frame | Display setting On: Displayed, Off: Not displayed | Off、 On |
| Flip Mode | Flip Mode setting  | Off、 H Flip、 V Flip、 H/V Flip |
| Recall Profile | Loading Factory settings and User presets Default: Recover all settings to factory setting User 1/2/3: Load the User settings 1/2/3 | Factory、 User1、 User2、 User3 |
| Save Profile | Save current User settings User 1/2/3: Save the current settings to User 1/2/3 | User1、 User2、 User3 |
| Source Scan*1 | Settings for auto-scan input signals when switch on the monitor On: Automatically scan Off: Stays the signal source when the monitor is switched off | On、 Off |
| Logo*2 | Settings to display Switch on logo or not On: Display, Off: Not display | On、 Off |
| Green Mode*3 | Display settings when in Energy Save mode | Black Backlight、 Standby、 Gray Backlight |
| Idle Duration | Set an idle time to enter Energy Save mode | Off、 30Sec、 2Hours、 4Hours |
| Update Driver*4 | Enter to upgrade Driver (USB firmware upgrade) | No、 Yes |
| Update Kernel*5 | Enter to upgrade Kernel (USB firmware upgrade) | No、 Yes |

*1 Source Scan

When set to "Yes", next time switch on the monitor, the monitor will automatically scan the available signal source with the sequence of "SDI1→SDI2→HDMI→YPbPr→VGA→CVBS".

*2 Logo

When powered on, the screen will display ProHD logo.

*3 Green Mode

When no recognized signal is detected and operation time reaches the time selected in "Idle Duration", the monitor will turn to green energy saving mode: "Green mode".

Under standby, Gray Backlight, Blacklight mode, press any button on the front panel, the monitor will be back to normal status.

Menu Configuration (cont.)

*4, *5 Update Driver/ Kernel

Operation steps:

1. Download latest firmware files to USB disk, switch on the monitor, and insert to the USB port on rear panel of the monitor
2. Press "MENU/ENTER", enter "Main Menu" - "System", and select "Update Driver" or "Update Kernel".
3. Set "Yes", the monitor will upgrade automatically.

| Main Menu | System |
|----------------|--------------------|
| Exit&Status > | Exit |
| Picture > | Aspect Ratio XX |
| Color Temp > | Scan Mode XXXX |
| Function Key > | Zoom Mode XXX |
| GPI > | Odd/Even Frame XXX |
| UMD > | Color Space XXX |
| Marker > | Freeze Frame XXX |
| Audio > | Flip Mode XXX |
| Vector > | Recall Profile XXX |
| Waveform > | Save Profile XXX |
| Display > | Source Scan XXX |
| System > | Logo XXX |
| OSD > | Green Mode XXX |
| Key Inhibit > | Idle Duration XXX |
| | Update Driver Yes |
| | Update Kernel XXX |

4. During firmware upgrade, the screen will display progress percentage. Please do not cut off power during the upgrade.

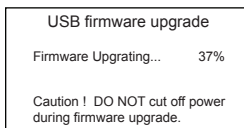

5. When succeed, the monitor will automatically re-start, and then the upgrade will be finished.

Color Measurement

3DLUT calibration by cube import and camera logs to Rec.709 Conversion

| Item | To do | Setting value |
|---------------------|---|---|
| Exit | Return Main Menu | |
| Log Mode*1 | Select a camera log LUT to convert to Rec.709 | Off、J-Log1、Log-c、S-Log2、S-Log3、C-Log、V-Log、RedLogFilm、User-Log |
| 1DLut | Select 1DLUT color files | Default、User1、User2 |
| Color Measurement*2 | Enable color measurement | Off、On |
| Import | Import 3DLUT calibration cube*3, camera log cube, user LUT cube or 1DLUT color file*4 | 3DLut.cube、J-Log1.cube、Log-C.cube、S-Log2.cube、S-Log3.cube、C-Log.cube、V-Log.cube、RedLogFilm.cube、User-Log.cube、1DLutUser1.csv、1DLutUser2.csv |
| Reset*5 | Reset to factory imported 3DLUT cubes | 3DLut.cube、J-Log1.cube、Log-C.cube、S-Log2.cube、S-Log3.cube、C-Log.cube、V-Log.cube、RedLogFilm.cube、User-Log.cube |

*1 Camera Log conversion

When shooting with Log mode of the camera, you can select the corresponding Log conversion LUT, to convert the log mode video to standard ITU Rec.709 mode to monitor. A "User-Log" is provided for user defined LUT converting to Rec.709.

*2 Color Measurement enable

Before re-calibrate the monitor and start to measure the monitor display colors, please turn the "Color Measurement" on. And please turn the "Color Measurement" off when measurement finished and return to normal monitoring. It will turn off automatically when new cubes are imported or monitor restarted.

*3 Import re-calibrated cube or user log cubes

- (1) Calibrate the monitor by color meters and 3DLUT calibrating software, select 17x17x17, 6500K, Gamma 2.4 to calibrate, and get a correct cube file. (Konica Minolta CA-310 color meter and Spectral CalMAN software are recommended for accurate calibration)
- (2) Rename the re-calibrated cube as "3DLut.cube" (attention to the cap letters), and copy into USB stick root directory.
- (3) Insert the USB stick onto monitor USB port on the rear panel, select "Import" - "3DLut.cube" - "YES" to import the new cube.

*4 Import User logs and 1DLut color file

You can change all the default camera log LUTs, User logs, and 1DLut colors by USB importing new cube file at the same file name.

*5 Reset to factory cubes

For any wrong cubes imported that caused wrong display colors, you can reset the cubes to factory cubes here.

OSD

Adjust the OSD display size, color, duration, and TALLY light/keyboard light settings

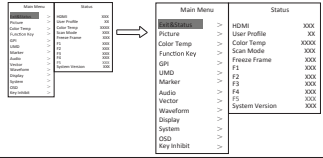
| Item | To do | Setting value |
|---------------------|---|----------------------------|
| Exit | Return Main Menu | |
| OSD Language | OSD Language setting | English、 Chinese |
| OSD Blending | OSD Blending setting | Low、 Medium、 High、 Off |
| OSD Duration*1 | OSD Duration setting | 10Sec、 15Sec、 30Sec、 60Sec |
| OSD Zoom | OSD Zoom setting  | Off、 On |
| Key Led Brightness | Key Led Brightness setting | Low、 Medium、 High、 Off |
| Tally-R Brightness | Set the brightness of tally when is red | High、 Low、 Medium |
| Tally-G Brightness | Set the brightness of tally when is green | High、 Low、 Medium |
| Soft-Tally Position | Set the position of soft-tally | Top、 Bottom |
| Soft-Tally Blinking | Set the blinking of soft-tally | On、 Off |

*1 During this period of time, if there's no operation to the menu, the menu will automatically quit.

Key Inhibit

To lock the keyboard for safety operation

| Item | To do | Setting value |
|-------------|---------------------|---------------|
| Exit | Return Main Menu | |
| Key Inhibit | Key Inhibit setting | Off、 On |

If the "Key Inhibit" is "On", there is no response when all the buttons except " VOLUME MENU/PUSH" are pressed, the screen will be displayed as " Key Inhibit".

User can set "Key Inhibit" under "key Inhibit" submenu to "Off" to recover the functions of all buttons.

External Control

About the external control

This monitor has three external control terminals.

- **RS-485 terminal** (RJ-45): Controls the monitor with the RS-485 system.
The terminal is to connect with TallyMan system of UMD application.
- **RS-232C terminal** (D-sub 9-pin): Controls the monitor with the RS-232C system (TallyMan)
The terminal is to connect with TallyMan system of UMD application.
- **Make contact terminal** (RJ-45):
Controls the monitor by short-circuiting the corresponding pin terminal to the GND pin terminal, or disconnecting (opening) it.
The terminal is to assign functions for GPI controlling.

Using the UMD control

<Specifications of the RS-485 terminal>

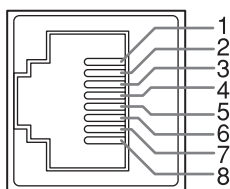

This is a female terminal.

| Pin No. | IN terminal signal | OUT terminal signal |
|---------|--------------------|---------------------|
| 1 | TXD + | TXD + |
| 2 | TXD - | TXD - |
| 3 | RXD + | RXD + |
| 4 | NC | NC |
| 5 | NC | NC |
| 6 | RXD - | RXD - |
| 7 | NC | NC |
| 8 | GND | GND |

<Serial communication>

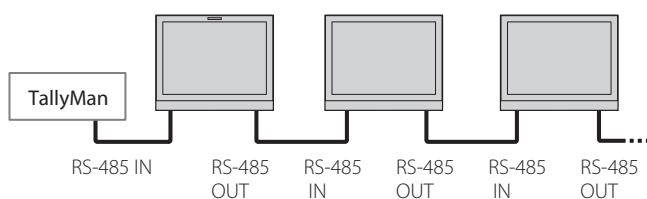

<Specifications of the RS-232C terminal>

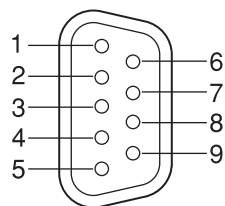

This is a female terminal.

| Pin No. | Signal |
|---------|--------|
| 1 | NC |
| 2 | RXD |
| 3 | TXD |
| 4 | NC |
| 5 | GND |
| 6 | NC |
| 7 | RTS |
| 8 | CTS |
| 9 | NC |

- The 7th terminal and the 8th terminal are connected.

Using the GPI control

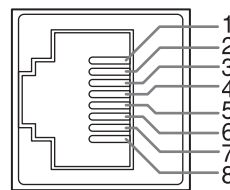

This is a female terminal.

| Pin No | Pin name |
|--------|----------|
| 1 | GPI 1 |
| 2 | GPI 2 |
| 3 | GPI 3 |
| 4 | GPI 4 |
| 5 | GPI 5 |
| 6 | GPI 6 |
| 7 | NC |
| 8 | GND |

To assign the functions to the pin terminals

- 1 Select "GPI" on the Main Menu.
- 2 Set "GPI control" to "ON".
- 3 Select a pin name ("Pin1" - "Pin6") for which you want to assign a function, then select the function you want to assign.

Operation of the external control

- 1 Operate each function by short-circuiting the corresponding pin terminal to the 8th pin terminal (GND) or opening it.

<Functions controlled by the GPI terminal>

| Display | Functions to be controlled | Opening | Short-circuiting |
|----------------|----------------------------|---------|------------------|
| --- | No function | — | — |
| Red Tally | Tally light red | off | Red |
| Green Tally | Tally light green | off | Green |
| Yellow Tally | Tally light yellow | off | Yellow |
| Aspect Ratio | Changes the aspect ratio. | | *1 |
| Scan Mode | Changes the scan mode | | *2 |
| Zoom Mode | Changes zoom mode | | *3 |
| Mute | Mute setting | | *4 |
| Freeze Frame | Freeze Frame setting | | *4 |
| Time code | Time code display | | *4 |
| Zebra | Zebra display | | *4 |
| Vector | Vector display | | *4 |
| Audio Bar | Audio Bar display | | *4 |
| Histogram | Histogram display | | *4 |
| False Color | False Color display | | *4 |
| AFD | AFD display | | *4 |
| H/V Delay | H/V Delay display | | *4 |
| Marker | Marker display | | *4 |
| Color Bar | Color Bar display | | *4 |
| UMD | UMD display | | *4 |
| Audio Alarm | Audio Alarm display | | *4 |
| Color Temp | Color Temp setting | | *5 |
| R/G/B/Mono | R/G/B/Mono setting | | *6 |
| Flip Mode | Flip Mode setting | | *7 |
| Odd/Even Frame | Odd/Even Mode setting | | *8 |

*1 For every short-circuiting, the Aspect Ratio value changes in the order of 16:9 → 4:3

*2 For every short-circuiting, the Scan Mode value changes in the order of Normal → Overscan → Native

*3 For every short-circuiting, the Zoom Mode value changes in the order of Off → Zoom1 → Zoom2

*4 For every short-circuiting, the value changes in the order of On → Off

*5 For every short-circuiting, the Color Temp value changes in the order of 6500K → 5600K → 9300K → User

*6 For every short-circuiting, the R/G/B/Mono value changes in the order of Off → Blue Only → Red Only → Green Only → Mono

*7 For every short-circuiting, the Flip Mode value changes in the order of Off → H Llip → V Flip → H/V Flip

*8 For every short-circuiting, the Odd/Even Frame Mode value changes in the order of Off → Odd Mode → Even Mode

Troubleshooting

Solutions to common problems related to the monitor are described here. If none of the solutions presented here solve the problem, unplug the monitor and consult an authorized dealer or service center.

| Symptom | Probable cause and corrective action | Page |
|-------------------------------------|---|--------|
| No power supply. | ● press "POWER" button | 8 |
| | ● Firmly insert the AC power plug. | 7 |
| No picture with the power on. | ● Select the correct input using the INPUT SELECT buttons. | 8 |
| | ● Connect the connecting cable firmly. | 7 |
| | ● Turn on the power of the connected component and set the output correctly. | — |
| | ● Check whether the input signal format is acceptable on the monitor. | 22 |
| No sound. | ● Adjust the volume level. | 9 |
| | ● Deactivate the muting function. | 11 |
| | ● Connect the connecting cable firmly. | 7 |
| | ● Turn on the power of the connected component and set the output correctly. | — |
| No Sync | ● Select the correct input using the INPUT SELECT buttons. | 8 |
| | ● Connect the connecting cable firmly. | 7 |
| | ● Turn on the power of the connected component and output video signals. Or, check whether the video output of the component (video output setting of the VCR or graphic board of the computer) is set correctly. | — |
| Wrong color, no color. | ● Adjust each picture adjustment knob on the front panel or adjust the items of "Picture" in the Main Menu. | 8, 11 |
| | ● Adjust the "Recall profile" to "Default" under "System" submenu | 15 |
| | ● Turn the Blue only/ Red Only/ Green Only/Mono off under R/G/B/Mono submenu | 15, 18 |
| | ● Turn off the "Focus Assist" function | 15, 18 |
| | ● Turn off the "False Color" function | 15, 18 |
| The picture becomes blurred. | ● Adjust the picture contrast or brightness by using the adjustment knobs on the front panel. Or, adjust "Contrast" or "Brightness" of "Picture" in the Main Menu. | 8, 11 |
| Buttons on the monitor do not work. | ● Set "Key Inhibit" in the Main Menu to "Off" | 17 |

● The following are not malfunctions.

- When a still image is displayed for a long time, it may remain indistinctly on the screen after the picture has changed. Though the remaining picture will disappear after a while, there may be a case that it remains for a long period depending on the length of time the still image was displayed for. This is due to the characteristics of the LCD display and is not a malfunction.
- Red spots, blue spots and green spots on the panel surface are a normal characteristic of LCD panels, and not a problem. The LCD panel is built with very high precision technology; however, be aware that a few pixels may be missing or constantly lit.
- The following symptoms are problems only when pictures or sounds are not played back normally.
 - A slight electric shock occurs when you touch the LCD panel.
 - The top and/or rear panel of the monitor becomes hot.
 - The monitor emits a cracking noise.
 - The monitor emits a mechanical noise.

Specifications

General

| | | |
|--|---|----------------------|
| Model name | DT-N17F | |
| Type | Multi format LCD monitor | |
| Screen size | Type 17.3 wide format | |
| Aspect ratio | 16:9 | |
| Horizontal/vertical frequency (computer signal) | H: 61.93 kHz – 92.9 kHz V: 50 Hz – 75 Hz * Some signals within this frequency range may not be displayed | |
| Compliant video signal format | ☞ "Available signals" on page 22 | |
| Format | 3G SDI: SMPTE-425M-A/B HD SDI: BTA S-004C, SMPTE292M, SMPTE-425M-A/B, SMPTE-274M, SMPTE-RP211, SMPTE-296M SD SDI: SMPTE-125M, ITU-R BT.656 2K: SMPTE ST 2048-1: 2011 EMBEDDED AUDIO: SMPTE299M, SMPTE272M | |
| Audio output | Internal speaker: 2.5W(8Ω) | |
| Operating conditions | Operating temperature: 0°C – 40°C (41°F – 95°F) Operating humidity: 20% – 80% (non-condensing) (Slightly variable depending on ambient conditions for installation.) | |
| Power requirements | AC 120 V / AC 220 – 240 V, 50 Hz/60 Hz; DC11 ~ 17V | |
| Rated current | 1.5A (AC 100V ~ 240V) 3.0A (DC11 ~ 17V) | |
| External dimensions (excluding protruding parts) | with the stand | without the stand |
| | Width: 430.5 mm (16 15/16") | 430.5 mm (16 15/16") |
| | Height: 328.7 mm (12 15/16") | 310.4 mm (12 1/4") |
| | Depth: 135 mm (5 1/4") | 73 mm (2 7/8") |
| Weight | 4.65 kg(10.25lbs) (with the stand) | |
| Accessories | AC power cord x 1 | |

LCD panel

| | |
|----------------------------|---|
| Type | 17.3" wide, active matrix TFT |
| Effective screen size | Width: 381.89 mm (15") Height: 214.81 mm (8 7/16") Diagonal: 439.42 mm (17 5/16") |
| Number of pixels displayed | 1920 x 1080 |
| Number of colors displayed | 262,144 |
| Viewing angle (TYP.) | 160° (Horizontally), 160° (Vertically) |
| Brightness (TYP.) | 300cd/m ² |
| Contrast ratio (TYP.) | 700:1 |

Input/output terminals

| | | |
|------------------|------------------------|---|
| Video | CVBS | Input/output of composite signal: 1 line, BNC connector x 2, 1 V (p-p), 75 Ω * The input (IN) and output (OUT) terminals |
| | HDMI | HDMI connector x 2(IN and OUT) |
| | VGA | 1 Line, mini D-SUB 15pin x1 (IN) |
| | YPbPr | Y: 1 V (p-p), 75 Ω (with sync) Pb: 0.7 V (p-p), 75 Ω Pr: 0.7 V (p-p), 75 Ω |
| | E. AUDIO 3G/ HD/SD SDI | Digital signal input (compatible with EMBEDDED AUDIO signals): auto detection, 2 line, BNC connector x 2 |
| | E. AUDIO 3G/ HD/SD SDI | Digital signal output (compatible with EMBEDDED AUDIO signals): auto detection, 2 line, BNC connector x 2 |
| Audio | AUDIO (IN) | Analog audio signal input: 1 line, RCA connector x 2, 500 mV (rms), high impedance |
| | AUDIO (MONITOR OUT) | Speaker: 2.5W+2.5W(8Ω) 3.5mm phone |
| External control | GPI (MAKE) | ☞ "Using the GPI control" on page 18. |
| | UMD (RS-485) | ☞ "Using the UMD control" on page 18. |
| | UMD (RS-232C) | |

Dimensions

Unit: mm (inch)

DT-N17F

<Front view>

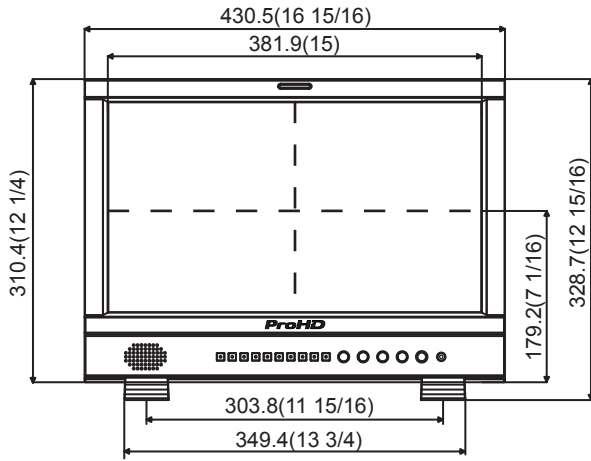

<Side view>

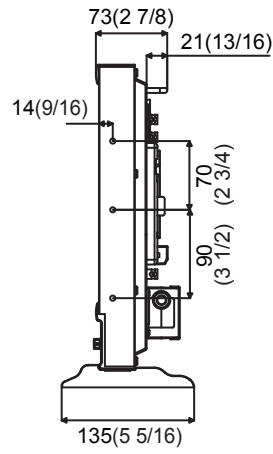

<Rear view>

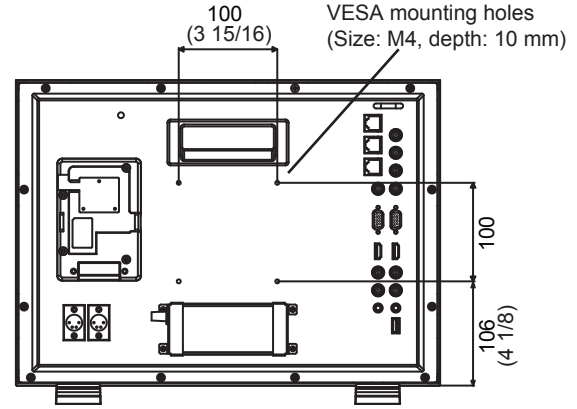

Specifications (cont.)

Available signals

The following signals are available for this monitor.

Video signals

| No. | Signal name | Signal format shown in the status display | Input terminal | | | | |
|-----|------------------|---|----------------|-------|-----|-----|------|
| | | | CVBS | YPbPr | VGA | SDI | HDMI |
| 1 | NTSC | NTSC | √ | — | — | — | — |
| 2 | NTSC 4.43 | NTSC | √ | — | — | — | — |
| 3 | PAL-M | PAL | √ | — | — | — | — |
| 4 | PAL | PAL | √ | — | — | — | — |
| 5 | PAL-N | PAL | — | — | — | — | — |
| 6 | SECAM | SECAM | √ | — | — | — | — |
| 7 | 480/60i | 480i59.94 | — | √ | — | √ | √ |
| 8 | 480/59.94i | 480i59.94 | — | √ | — | √ | √ |
| 9 | 576/50i | 576i50 | — | √ | — | √ | √ |
| 10 | 480/60p | 480p59.94 | — | √ | — | — | √ |
| 11 | 480/59.94p | 480p59.94 | — | √ | — | — | √ |
| 12 | 576/50p | 576p50 | — | √ | — | — | √ |
| 13 | 640*480/60p | 640*480 | — | √ | √ | — | √ |
| 14 | 640*480/59.94p | 640*480 | — | √ | √ | — | √ |
| 15 | 720/60p | 720p60 | — | √ | — | √ | √ |
| 16 | 720/59.94p | 720p59.94 | — | √ | — | √ | √ |
| 17 | 720/50p | 720p50 | — | √ | — | √ | √ |
| 18 | 1080/60i | 1080i60 | — | √ | — | √ | √ |
| 19 | 1080/59.94i | 1080i59.94 | — | √ | — | √ | √ |
| 20 | 1080/50i | 1080i50 | — | √ | — | √ | √ |
| 21 | 1080/60p | 1080p60 | — | √ | √ | √ | √ |
| 22 | 1080/59.94p | 1080p59.94 | — | √ | √ | √ | √ |
| 23 | 1080/50p | 1080p50 | — | √ | √ | √ | √ |
| 24 | 1080/30p | 1080p30 | — | √ | — | √ | √ |
| 25 | 1080/29.97p | 1080p30 | — | √ | — | √ | √ |
| 26 | 1080/25p | 1080p25 | — | √ | — | √ | √ |
| 27 | 1080/24p | 1080p24 | — | √ | — | √ | √ |
| 28 | 1080/23.98p | 1080p24 | — | √ | — | √ | √ |
| 29 | 1080/30PsF | 1080PsF30 | — | — | — | √ | √ |
| 30 | 1080/29.97PsF | 1080PsF30 | — | — | — | √ | √ |
| 31 | 1080/25PsF | 1080PsF25 | — | — | — | √ | √ |
| 32 | 1080/24PsF | 1080PsF24 | — | — | — | √ | √ |
| 33 | 1080/23.98PsF | 1080PsF24 | — | — | — | √ | √ |
| 34 | 2048*1080/23.98p | 1080p24 | — | — | — | √ | — |
| 35 | 2048*1080/24p | 1080p24 | — | — | — | √ | — |
| 36 | 2048*1080/25p | 1080p25 | — | — | — | √ | — |
| 37 | 2048*1080/29.97p | 1080p30 | — | — | — | √ | — |
| 38 | 2048*1080/30p | 1080p30 | — | — | — | √ | — |
| 39 | 2048*1080/50p | 1080p50 | — | — | — | √ | — |
| 40 | 2048*1080/59.94p | 1080p59.94 | — | — | — | √ | — |
| 41 | 2048*1080/60p | 1080p60 | — | — | — | √ | — |
| 42 | 2048*1080/50i | 1080i50 | — | — | — | √ | — |
| 43 | 2048*1080/59.94i | 1080i59.94 | — | — | — | √ | — |
| 44 | 2048*1080/60i | 1080i60 | — | — | — | √ | — |

√: Acceptable

—: Not acceptable

For signal formats other than E.Audio 3G/HD/SD SDI input, **/59.94, **/29.97, and **/23.98 will be displayed as **/60, **/30, and **/24 respectively.

Specifications (cont.)

Computer signals (preset)

Analog RGB input (COMP./RGB terminals) and DVI input (HDMI terminal):

| No. | Signal name | Resolution | | Frequency | | Scan system |
|-----|-------------|------------|----------|------------------|---------------|---------------|
| | | Horizontal | Vertical | Horizontal (kHz) | Vertical (Hz) | |
| 1 | VGA60 | 640 | 480 | 31.5 | 59.9 | Non-interlace |
| 2 | SVGA60 | 800 | 600 | 37.9 | 60.3 | Non |
| 3 | XGA60 | 1024 | 768 | 48.4 | 60.0 | Non |
| 4 | WXGA(1280) | 1280 | 768 | 47.8 | 60.0 | Non |
| 5 | WXGA+60*1 | 1440 | 900 | 55.9 | 60.0 | Non |
| 6 | SXGA60*1 | 1600 | 1200 | 75.0 | 60.0 | Non |
| 7 | 1080/60p*1 | 1920 | 1080 | 67.5 | 60.0 | Non |
| 8 | WXGA(1360) | 1360 | 768 | 47.7 | 60.0 | Non |

*1 No. 5, 6, 7, signals come in, thin lines will become obscured because their signal resolution is higher than the screen resolution.

- Non-preset signals may not be displayed normally even if the frequency is within the acceptable range.

Specification of the HDMI terminal

Connect it to the HDMI output terminal of a video device.

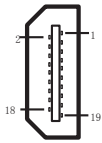

| Pin No. | Input signal | Pin No. | Input signal | Pin No. | Input signal |
|---------|-----------------------|---------|-----------------------|---------|-----------------|
| 1 | T.M.D.S Data 2+ | 8 | T.M.D.S Data 0 shield | 15 | SCL |
| 2 | T.M.D.S Data 2 shield | 9 | T.M.D.S Data 0- | 16 | SDA |
| 3 | T.M.D.S Data 2- | 10 | T.M.D.S Clock+ | 17 | DDC/CEC GND |
| 4 | T.M.D.S Data 1+ | 11 | T.M.D.S Clock shield | 18 | +5 V Power |
| 5 | T.M.D.S Data 1 shield | 12 | T.M.D.S Clock- | 19 | Hot Plug Detect |
| 6 | T.M.D.S Data 1- | 13 | Spare (not connected) | | |
| 7 | T.M.D.S Data 0+ | 14 | Spare (not connected) | | |

Specification of the mini D-SUB15pin terminal

Connect it to the mini D-SUB15pin output terminal of a video device.

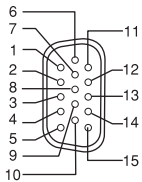

| Pin No. | Input signal | Pin No. | Input signal | Pin No. | Input signal |
|---------|-------------------------|---------|---------------------------|---------|-----------------------------------|
| 1 | Red video signal | 7 | Green video signal return | 13 | Horizontal synchronization signal |
| 2 | Green video signal | 8 | Blue video signal return | 14 | Vertical synchronization signal |
| 3 | Blue video signal | 9 | Not connected | 15 | I2C clock |
| 4 | Not connected | 10 | Ground | | |
| 5 | Ground | 11 | Not connected | | |
| 6 | Red video signal return | 12 | I2C data | | |

Notice on transportation

This monitor is precision equipment and needs dedicated packing material for transportation. Never use any packing material supplied from sources other than JVC or JVC-authorized dealers.

- For easy understanding, pictures and illustrations are shown by being emphasized, omitted or composed, and may be slightly different from actual products.
- Design and specifications are subject to change without notice.
- All company names and product names mentioned herein are used for identification purposes only, and may be the trademarks or registered trademarks of their respective companies.

This model is manufactured by SWIT Electronics Co., Ltd.
and distributed, warranted and supported in Europe by JVCKENWOOD Deutschland GmbH

To obtain service or for further information, please contact:
JVCKENWOOD Deutschland GmbH · Konrad-Adenauer-Allee 1-11 · 61118 Bad Vilbel
Telefon: +49 (0) 6101 / 4988 - 0 · Telefax: +49 (0) 6101 / 4988 - 50
www.jvcpro.eu

ProHD

SWIT Electronics Co., Ltd.
10 Hengtong Road, Nanjing Economic and Technological Development Zone
Nanjing 210038, P.R.China
Tel: +86-25-85805753 Fax: +86-25-85805296 Email: contact@swit.cc
www.swit.cc