



REMOTE CAMERA CONTROLLER

RM-LP100U

RM-LP100E

INSTRUCTIONS

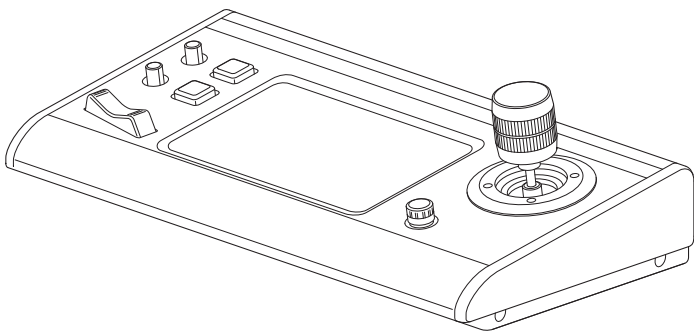

Specifications and appearance of this unit are subject to change for further improvement without prior notice.

Details

For details on settings and operation, refer to "INSTRUCTIONS" on the website.

Please check the latest INSTRUCTIONS, tools, etc. from the URL below.

North America:

<http://pro.jvc.com/prof/main.jsp>

Europe:

<http://www.service.jvcpro.eu/public/>

China:

<http://www.jvc.com.cn/service/download/index.html>

Thank you for purchasing this product.

Before beginning to operate this unit, please read the "INSTRUCTIONS" carefully to ensure proper use of the product. In particular, please read through the "Safety Precautions" to ensure safe use of the product. After reading, store them with the warranty card and refer to them whenever needed.

The serial number is crucial for the purpose of quality control. After purchasing this product, please check to ensure that the serial number is indicated correctly on this product, and the same serial number is also indicated on the warranty card.

For Customer Use:

Enter below the Serial No. which is located on the body.
Retain this information for future reference.

Model No. RM-LP100U

Serial No. _____

Please read the following before getting started:

Thank you for purchasing this JVC product.
Before operating this unit, please read the instructions carefully to ensure the best possible performance.

In this manual, each model number is described without the last letter (U/E) which means the shipping destination.
(U: for USA and Canada, E: for Europe)
Only "U" models (RM-LP100U) have been evaluated by UL.

Safety Precautions

Cautions



The lightning flash with arrowhead symbol, within an equilateral triangle, is intended to alert the user to the presence of uninsulated "dangerous voltage" within the product's enclosure that may be of sufficient magnitude to constitute a risk of electric shock to persons.



The exclamation point within an equilateral triangle is intended to alert the user to the presence of important operating and maintenance (servicing) instructions in the literature accompanying the appliance.

CAN ICES-3 A / NMB-3 A

CAUTION:

A UNIT IS A CLASS 1 LASER PRODUCT. HOWEVER THIS UNIT USES A VISIBLE LASER BEAM WHICH COULD CAUSE HAZARDOUS RADIATION EXPOSURE IF DIRECTED. BE SURE TO OPERATE THE UNIT CORRECTLY AS INSTRUCTED.

WHEN THIS UNIT IS PLUGGED INTO THE WALL OUTLET, DO NOT PLACE YOUR EYES CLOSE TO THE OPENING OF THE DISC TRAY AND OTHER OPENINGS TO LOOK INTO THE INSIDE OF THIS UNIT.

USE OF CONTROLS OR ADJUSTMENTS OR PERFORMANCE OF PROCEDURES OTHER THAN THOSE SPECIFIED HEREIN MAY RESULT IN HAZARDOUS RADIATION EXPOSURE.

DO NOT OPEN COVERS AND DO NOT REPAIR YOURSELF. REFER SERVICING TO QUALIFIED PERSONNEL.

MISE EN GARDE:

CET APPAREIL EST UN PRODUIT LASER DE CLASSE 1. CEPENDANT, CET APPAREIL UTILISE UN FAISCEAU LASER VISIBLE QUI PEUT ENTRAÎNER UNE EXPOSITION DANGEREUSE AUX RAYONNEMENTS. S'ASSURER DE FAIRE FONCTIONNER L'APPAREIL CORRECTEMENT, EN RESPECTANT LES INSTRUCTIONS.

LORSQUE CET APPAREIL EST BRANCHÉ À UNE PRISE MURALE, NE PAS PLACER SES YEUX PRÈS DE L'OUVERTURE DU TIROIR POUR DISQUE OU D'AUTRES OUVERTURES DANS LE BUT D'OBSERVER L'INTÉRIEUR DE L'APPAREIL.

L'UTILISATION DES COMMANDES, RÉGLAGES OU PROCÉDURES DE PERFORMANCE AUTRE QUE CELLE SPÉCIFIÉE DANS CE DOCUMENT RISQUE D'ENTRAÎNER UNE EXPOSITION DANGEREUSE AUX RAYONNEMENTS.

L'UTILISATEUR NE DOIT PAS OUVRIR NI RÉPARER L'APPAREIL DE LUI-MÊME. FAIRE APPEL À UN PERSONNEL QUALIFIÉ POUR L'ENTRETIEN.

WARNING:

TO PREVENT FIRE OR SHOCK HAZARD, DO NOT EXPOSE THIS UNIT TO RAIN OR MOISTURE.

CAUTION:

This unit should be used with AC 120 V \sim , 60 Hz. To prevent electric shocks and fire hazards, DO NOT use any other power source.

CAUTION:

TO PREVENT ELECTRIC SHOCK, MATCH WIDE BLADE OF PLUG TO WIDE SLOT, FULLY INSERT.

ATTENTION:

POUR ÉVITER LES CHOC ÉLECTRIQUES, INTRODUIRE LA LAME LA PLUS LARGE DE LA FICHE DANS LA BORNE CORRESPONDANTE DE LA PRISE ET POUSSER JUSQU'AU FOND.

Note to CATV system installer:

This reminder is provided to call the CATV system installer's attention to Article 820-40 of the NEC that provides guidelines for proper grounding and, in particular, specifies that the cable ground shall be connected to the grounding system of the building, as close to the point of cable entry as practical.

"WARNING" and the following or equivalent. "To reduce the risk of fire or electric shock, do not expose this apparatus to rain or moisture."

"ATTENTION" et suivant ou équivalent. "Pour limiter les risques d'incendie ou d'électrocution, n'exposez pas cet appareil à la pluie ou à l'humidité."

A warning that an apparatus with CLASS I construction shall be connected to a MAINS socket outlet with protective earthing connection.

Avertissement: un appareil de CLASSE I doit être branché à une prise SECTEUR comprenant une mise à la terre de protection.

WARNING

Batteries shall not be exposed to excessive heat such as sunshine, fire or the like.

When the main plug or appliance coupler shall remain readily operable.

IMPORTANT SAFETY INSTRUCTIONS

- 1) Read these instructions.
- 2) Keep these instructions.
- 3) Heed all warnings.
- 4) Follow all instructions.
- 5) Do not use this apparatus near water.
- 6) Clean only with dry cloth.
- 7) Do not block any ventilation openings. Install in accordance with the manufacturer's instructions.
- 8) Do not install near any heat sources such as radiators, heat registers, stoves, or other apparatus (including amplifiers) that produce heat.
- 9) Do not defeat the safety purpose of the polarized or grounding-type plug. A polarized plug has two blades with one wider than the other. A grounding type plug has two blades and a third grounding prong. The wide blade or the third prong are provided for your safety. If the provided plug does not fit into your outlet, consult an electrician for replacement of the obsolete outlet.
- 10) Protect the power cord from being walked on or pinched particularly at plugs, convenience receptacles, and the point where they exit from the apparatus.
- 11) Only use attachments/accessories specified by the manufacturer.
- 12) Use only with the cart, stand, tripod, bracket, or table specified by the manufacturer, or sold with the apparatus. When a cart is used, use caution when moving the cart/apparatus combination to avoid injury from tip-over.
- 13) Unplug this apparatus during lightning storms or when unused for long periods of time.
- 14) Refer all servicing to qualified service personnel. Servicing is required when the apparatus has been damaged in any way, such as power-supply cord or plug is damaged, liquid has been spilled or objects have fallen into the apparatus, the apparatus has been exposed to rain or moisture, does not operate normally, or has been dropped.



Failure to heed the following precautions may result in damage to the unit, remote control or disc/cassette.

1. **DO NOT place the unit—**
 - in an environment prone to extreme temperatures or humidity.
 - in direct sunlight.
 - in a dusty environment.
 - in an environment where strong magnetic fields are generated.
 - on a surface that is unstable or subject to vibration.
2. **DO NOT block the unit's ventilation openings or holes.**
(If the ventilation openings or holes are blocked by a newspaper or cloth, etc., the heat may not be able to get out.)
3. **DO NOT place heavy objects on the unit or remote control.**
4. **DO NOT place anything which might spill on top of the unit or remote control.**
(If water or liquid is allowed to enter this equipment, fire or electric shock may be caused.)
5. **DO NOT expose the apparatus to dripping or splashing.**
6. **DO NOT use this equipment in a bathroom or places with water.** Also **DO NOT** place any containers filled with water or liquids (such as cosmetics or medicines, flower vases, potted plants, cups, etc.) on top of this unit.
7. **DO NOT place any naked flame sources, such as lighted candles, on the apparatus.**
8. **AVOID violent shocks to the unit during transport.**

CAUTION:

Changes or modifications not approved by JVC could void user's authority to operate the equipment.

Declaration of Conformity

Model Number: RM-LP100U
 Trade Name: JVC
 Responsible Party: JVCKENWOOD USA Corporation
 Address: 1700 Valley Road Wayne, N.J. 07470
 Telephone Number: 973-317-5000
 This device complies with Part 15 of FCC Rules.
 Operation is subject to the following two conditions:

(1) This device may not cause harmful interference, and (2) this device must accept any interference received, including interference that may cause undesired operation.

"This equipment has been tested and found to comply with the limits for a Class A digital device, pursuant to Part 15 of the FCC Rules. These limits are designed to provide reasonable protection against harmful interference when the equipment is operated in a commercial environment. This equipment generates, uses, and can radiate radio frequency energy and, if not installed and used in accordance with the instruction manual, may cause harmful interference to radio communications. Operation of this equipment in a residential area is likely to cause harmful interference in which case the user will be required to correct the interference at his own expense."

When the equipment is installed in a cabinet or a shelf, make sure that it has sufficient space on all sides to allow for ventilation (10cm or more on both sides, on top and at the rear).

When discarding batteries, environmental problems must be considered and the local rules or laws governing the disposal of these batteries must be followed strictly.

Use the supplied power cord.

(If not, fire or electric shock may be caused.)

DON'T continue to operate the equipment if you are in any doubt about it working normally, or if it is damaged in any way/switch off, withdraw the mains plug and consult your dealer. DO be careful with glass panels or doors on equipment. DO consult you dealer if you are ever in doubt about the installation, operation or safety of your equipment.

NEVER let anyone especially children push anything into holes, slots or any other opening in the case—this could result in a fatal electrical shock.

MOISTURE CONDENSATION

Moisture in the air will condense on the unit when you move it from a cold place to a warm place, or under extremely humid conditions—just as water droplets form on the surface of a glass filled with cold liquid. In conditions where condensation may occur, disconnect the unit's power plug from the wall and keep it disconnected for a few hours to let the moisture dry, then turn on the unit.

Batteries—Incorrect use of batteries may cause the batteries to burst or ignite. A leaky battery may corrode the equipment, dirty your hands or spoil your clothing. In order to avoid these problems, make sure to observe the precautions below:

- Use the specified batteries only.
- Install the batteries with due attention to the plus (+) and minus (-) sides of the batteries according to the instructions in the compartment.
- Do not mix old and new batteries.
- Do not mix batteries of different types. Voltage specifications of batteries of the same shape may vary.
- Replace an exhausted battery with a new one promptly.
- If you will not use the remote control for a long time, remove the batteries.
- If leaked battery fluid gets on your skin or clothing, rinse immediately and thoroughly. If it gets into your eye, bathe your eye well rather than rubbing and seek medical treatment immediately. Leaked battery fluid that gets into your eye or your clothing may cause a skin irritation or damage your eye.
- Do not put the batteries in a place where young children can reach.



If this symbol is shown, it is only valid in the European Union.



HOW TO USE THIS INSTRUCTION MANUAL

- All major sections and subsections are listed in the Table Of Contents on page 5. Use this when searching for information on a specific procedure or feature.
- The  mark signals a reference to another page for instructions or related information.
- Operation buttons necessary for the various procedures are clearly indicated through the use of illustrations at the beginning of each major section.

DISCLAIMER OF LIABILITY

JVC shall not be liable for any loss relating to the unit's failure to properly record, store or playback any content (video, audio or otherwise) for any reason whatsoever. Any applicable warranties shall only cover replacement or repair of the effected unit, and shall not apply to recovery or replacement of lost content.

ATTENTION:

- Using a mobile phone in the vicinity of the unit may cause picture vibration on the TV screen or change the screen to a black back display.
- Some TVs or other appliances generate strong magnetic fields. Do not place such appliances on top of the unit as it may cause picture disturbance.
- When moving the product, press  /  to turn off the power, and wait at least 30 seconds before unplugging the power cord. Then, wait at least 2 minutes before moving the product.
- If there is a power outage when using the unit, the recorded data may be erased.
- It is recommended to back up discs which contain important recordings periodically (every few years). As digital signals do not deteriorate, failure to play back or record might arise due to the effects of the disc aging through the years depending on the storage environment.
- Recorded programs and data cannot be restored once the disc or tape is damaged.

The rating plate and the safety caution are on the rear of the unit.

WARNING : DANGEROUS VOLTAGE INSIDE
WARNING : TO PREVENT FIRE OR SHOCK HAZARD,
DO NOT EXPOSE THIS UNIT TO RAIN OR
MOISTURE.

Dear Customer, [European Union]

This apparatus is in conformance with the valid European directives and standards regarding electromagnetic compatibility and electrical safety.

European representative of JVC KENWOOD Corporation is:
 JVC Technical Services Europe GmbH
 Konrad-Adenauer-Allee 1-11
 61118 Bad Vilbel
 GERMANY

Sehr geehrter Kunde, [Europäische Union]
sehr geehrte Kundin,

dieses Gerät stimmt mit den gültigen europäischen Richtlinien und Normen bezüglich elektromagnetischer Verträglichkeit und elektrischer Sicherheit überein.

Die europäische Vertretung für die
 JVC KENWOOD Corporation ist:
 JVC Technical Services Europe GmbH
 Konrad-Adenauer-Allee 1-11
 61118 Bad Vilbel
 DEUTSCHLAND

WARNING

This is a Class A product. In a domestic environment this product may cause radio interference in which case the user may be required to take adequate measures.

IMPORTANT:

- Please read the various precautions on pages 5 to 6 before installing or operating the unit.
- It should be noted that it may be unlawful to re-record pre-recorded tapes, DVDs, or discs without the consent of the owner of copyright in the sound or video recording, broadcast or cable programme and in any literary, dramatic, musical, or artistic work embodied therein.

CAUTION:

- When you are not using the unit for a long period of time, it is recommended that you disconnect the power cord from the mains outlet.
- Dangerous voltage inside. Refer internal servicing to qualified service personnel. To prevent electric shock or fire hazard, remove the power cord from the mains outlet prior to connecting or disconnecting any signal lead or aerial.
- The mains plug shall remain readily operable.

The STANDBY/ON ⏻ /I button does not completely shut off mains power from the unit, but switches operating current on and off. “ ⏻ ” shows electrical power standby and “I” shows ON.

A warning that an apparatus with CLASS I construction shall be connected to a MAINS socket outlet with protective earthing connection.

Main Plug

The Main Plug is used as the disconnect device, the disconnect device shall remain readily operable

Even if the display window of the unit is unlit, the main power supply is not cut off unless the power cord is unplugged.

The main power supply for this unit is controlled by inserting or removing the power plug.

POWER CONNECTION

The power supply voltage rating of this product is AC 220 – 240 V (For European countries, Asian countries, and United Kingdom).

The power cord attached conforms to the following power supply voltage and countries. Use only the power cord designated to ensure safety and EMC regulations of each country.

For European and Asian countries: AC 220 – 240 V

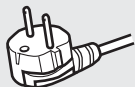

For United Kingdom: AC 220 – 240 V



This plug will fit only into a grounded power outlet. If you are unable to insert the plug into the outlet, contact your electrician to install the proper outlet. Do not defeat the safety purpose of the grounded plug.

- This product should be operated only with the type of power source indicated on the label. If you are not sure of the type of power supply of your home, consult your product dealer or local electric power company.

Warning:

- Do not use the same power cord for AC 120 V as for AC 220 – 240 V. Doing so may cause malfunction, electric shock or fire.

Note for United Kingdom power cord only

The plug of United Kingdom power cord has a built-in fuse. When replacing the fuse, be sure to use only a correctly rated approved type, re-fit the fuse cover. (Consult your dealer or qualified personnel.)

How to replace the fuse

Open the fuse compartment with the blade screwdriver, and replace the fuse.

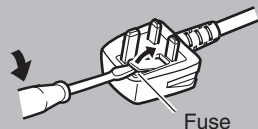

Fuse

This equipment has been designed and manufactured to meet international safety standards but, like any electrical equipment, care must be taken if you are to obtain the best results and safety is to be assured.

- DO read the operating instructions before you attempt to use the equipment.
- DO ensure that all electrical connections (including the mains plug, extension leads and interconnections between pieces of equipment) are properly made and in accordance with the manufacturer's instructions. Switch off and withdraw the mains plug when making or changing connections.
- DO consult your dealer if you are ever in doubt about the installation, operation or safety of your equipment.
- DO be careful with glass panels or doors on equipment.
- DON'T continue to operate the equipment if you are in any doubt about it working normally, or if it is damaged in any way—switch off, withdraw the mains plug and consult your dealer.
- DON'T remove any fixed cover as this may expose dangerous voltages.
- DON'T leave equipment switched on when it is unattended unless it is specifically stated that it is designed for unattended operation or has a standby mode. Switch off using the switch on the equipment and make sure that your family knows how to do this. Special arrangements may need to be made for infirm or handicapped people.
- DON'T use equipment such as personal stereos or radios so that you are distracted from the requirements of road safety. It is illegal to watch television whilst driving.
- DON'T listen to headphones at high volume, as such use can permanently damage your hearing.
- DON'T obstruct the ventilation of the equipment, for example with curtains or soft furnishings. Overheating will cause damage and shorten the life of the equipment.
- DON'T use make shift stands and NEVER fix legs with wood screws—to ensure complete safety always fit the manufacturer's approved stand or legs with the fixings provided according to the instructions.
- DON'T allow electrical equipment to be exposed to rain or moisture.

ABOVE ALL...

- NEVER let anyone especially children push anything into holes, slots or any other opening in the case^this could result in a fatal electrical shock;
- NEVER guess or take chances with electrical equipment of any kind—it is better to be safe than sorry!

关于环保使用期限



环保使用期限

- 此图标表示了中华人民共和国的法律所规定的环保使用期限。只要用户在使用本产品时遵守注意事项中的各项规定，从制造日期开始到此图标标出的期限为止（环保使用期限）既不会污染环境也不会产生对人体有害的物质。
- 附件和消耗性零件的环保使用期限如下所示：
（不同产品中包含的附件和消耗性零件也不相同。）
遥控器、交流转换器、电缆类：10年

关于产品中的有害物质

部件名称	有害物质					
	铅 (Pb)	汞 (Hg)	镉 (Cd)	六价铬 (Cr(VI))	多溴联苯 (PBB)	多溴二苯醚 (PBDE)
线路板组件	×	○	○	×	○	○
机箱	×	○	○	×	○	○
液晶显示屏模块	×	○	○	×	○	○
交流转换器	×	○	○	×	○	○
其他附件	×	○	○	×	○	○

本表格依据 SJ/T11364 的规定编制。

○：表示该有害物质在该部件所有均质材料中的含量均在 GB/T26572 规定的限量要求以下。

×：表示该有害物质至少在该部件的某一均质材料中的含量超出 GB/T26572规定的限量要求。

For RM-LP100E
GB4943.1-2011
GB9254-2008
GB17625.1-2012

Contents

Getting Started

Safety Precautions	2
Contents	8
Supplied Accessories	8
Main Features	9
Precautions	9
Name of Parts	10
Preparations	12

Operation

Selecting and Operating a Camera	13
Selecting a Camera	13
Operating a Camera	13
Recording Video to the Camera	13
Changing an Assigned Function	14
Selecting the Position	14
Adjusting the Camera Functions	15
Adjusting the White Balance (R/B Gain)	15
Adjusting Exposure Mode (EXPOSURE)	15
Adjusting the Brightness	16
Setting the Camera Image Quality (Detail)	16
Starting the Streaming	16

Settings

Setup Flow	17
Basic Operations of Menu Screen	17
Menu Screen Flow	18
System Setup	21
Switching the Camera Video Output On/Off	21
IP Setup	22
Registering the IP Address	22
Network Settings on This Controller	22
Tally Setup	23
Tally Control Interface	23
Camera Settings Menu	23

Others

Troubleshooting	24
Confirming the "OPEN SOURCE LICENSE"	24
Connection Diagram	24
Specifications	25

Content of this Manual

Symbols used

- Caution** : Describes precautions concerning the operation of this product.
- Memo** : Describes reference information, such as functions and usage restrictions of this product.
-  : Indicates the reference page numbers and reference items.

Content of this manual

- All rights reserved by JVC KENWOOD Corporation. Unauthorized duplication or reprinting of this manual, in whole or in part, is strictly prohibited.
- Illustrated designs, specifications and other contents of this manual are subject to change for improvement without prior notice.
- Other product and company names included in this instruction manual are trademarks and/or registered trademarks of their respective companies. Marks such as ™ and ® have been omitted in this manual.

Supplied Accessories

Accessories	
Warranty Card (U model only)	1
INSTRUCTIONS (BASIC)	1
AC Adapter	1
Power Cord (U model: 1, E model: 2)	
Wire Clamp	1
Screw (M3)	1

Main Features

The features for the combination of this unit and the HD PTZ REMOTE CAMERA (KY-PZ100) are as follows.

Simple Operation with LCD Touch Panel

Equipped with full color LCD touch panel, which makes operation easy through its versatile screen configuration.

Operate Camera Freely with Control Lever and Customized Buttons

Equipped with a control lever and customized buttons assignable with functions, which enhances the operability of the camera.

Also enables smooth pan/tilt operation.

Control up to 100 units of HD PTZ REMOTE CAMERA

Up to 100 units of HD PTZ REMOTE CAMERA (KY-PZ100) can be controlled.

Precautions

Storage and Usage Locations

Avoid using or placing this unit in the following places.

It might result in malfunctions or failure.

- Hot or cold places that are beyond the allowable operating temperature range (0 °C to 40 °C (32 °F to 104°F)).
- Locations beyond or below the allowable operating humidity range of 20 %RH to 90 %RH. (Condensation is not allowed)
- Near equipment that emits strong magnetic fields, such as transformers or motors.
- Near equipment that emits radio waves, such as transceivers and mobile phones.
- Locations with excessive dust and sand.
- Locations prone to moisture such as window side.
- Locations that are subjected to radiation, X-rays, salt attack or corrosive gases.
- Places subject to smoke or vapor such as near a cooking stove
- Places subject to strong vibrations or unstable surfaces

In a parked car under direct sunlight or near a heater for long hours

Protect this unit against penetration of dust when using it in a place subject to sandy dust.

Handling Precautions

Do not rub against or press the surface of the touch panel with a knife or a sharp object.

Do not apply excessive force to this unit; do not lift this unit while holding the control lever.

Maintenance

Turn off the power before performing any maintenance.

Wipe using a soft cloth. Wiping with thinner or benzene may melt or tarnish its surface. For tough stains, wipe using a cloth that is dipped into a neutral detergent diluted with water, followed by wiping with a dry cloth.

Cautions on Installing this Unit on a Desktop

Install this unit such that it does not fall from the desktop due to vibrations.

Energy Saving

When this unit is not in use, set the Power switch to “OFF” to reduce power consumption.

Name of Parts

| Front Panel

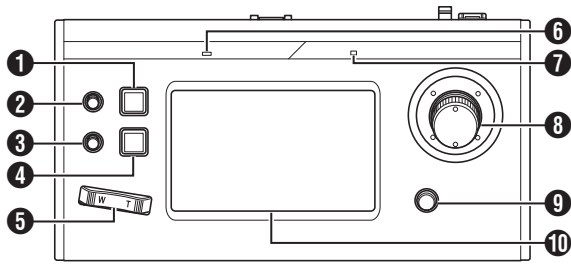

- 1** USER1 button
For switching the settings menu.
- 2** F1 knob
Used for the multi-function settings.
- 3** F2 knob
Used for the multi-function settings.
- 4** USER2 button
For switching the settings menu.
- 5** Zoom lever
For performing the zoom operation of the remote camera.
- 6** ALARM lamp
Red : Lights up when the alarm is activated.
- 7** POWER lamp
Green : Lights up while the power is turned on.
- 8** Control lever (F3)
 - For operating pan/tilt of the remote camera.
 - Used for the multi-function settings.
- 9** Focus knob/Push auto button
 - For performing the focus operation of the remote camera.
 - Used for the one-push auto focus function.
- 10** Operation panel
Used as a touch panel.

| Rear Panel

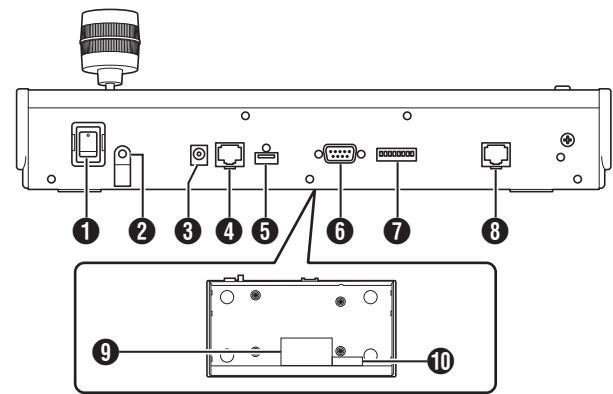

- 1** Power switch
For turning the power on or off.
- 2** Wire Clamp
For preventing the AC adapter cable from falling out.
- 3** DC 12V terminal
For connecting the supplied AC adapter.
- 4** LAN terminal
For connecting a LAN cable.
- 5** SERVICE terminal
For use during servicing.
- 6** TALLY terminal
Used for TALLY connection.
- 7** SETTING switch
1 to 4 : For switching TALLY IN and OUT.
5 to 8 : Used for servicing only.
- 8** SERIAL terminal
Not used.
- 9** Rating label
- 10** MAC address label

| Installing the Wire Clamp

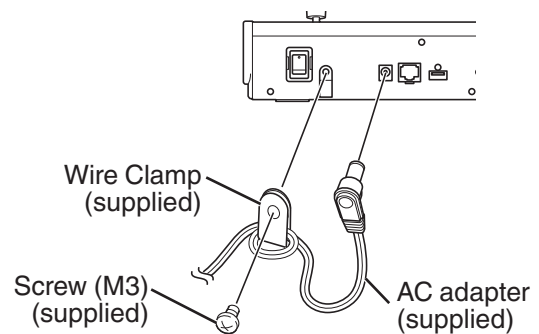

Camera Operation Screen

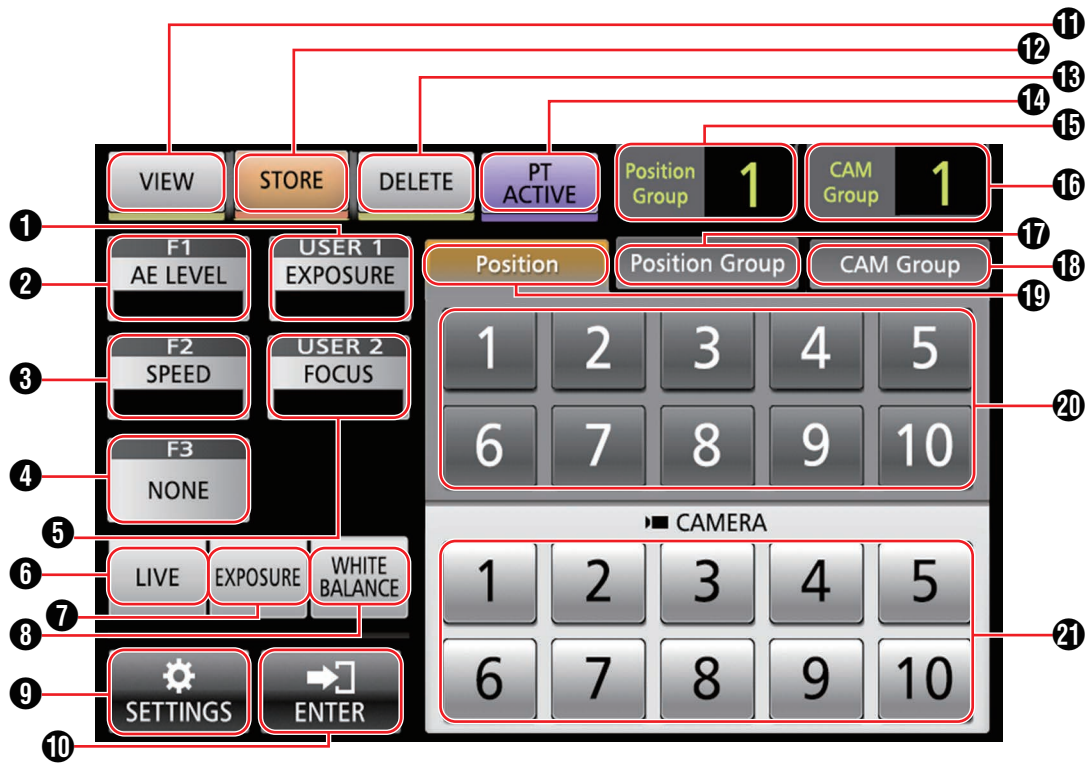

- 1 [USER1]**
The function assigned to the [USER1] button can be configured.
The default function assigned is "EXPOSURE".
- 2 [F1]**
The function assigned to the [F1] knob can be configured.
The default function assigned is "AE LEVEL".
- 3 [F2]**
The function assigned to the [F2] knob can be configured.
The default function assigned is "SPEED".
- 4 [F3]**
The function assigned to the [F3] lever can be configured.
The default function assigned is "NONE".
- 5 [USER2]**
The function assigned to the [USER2] button can be configured.
The default function assigned is "FOCUS".
- 6 [LIVE]**
Tap the button to activate the presets for LIVE.
F1:AE LEVEL, F2:SPEED, F3:NONE, USER1:FOCUS, USER2:REC
- 7 [EXPOSURE]**
Tap the button to activate the presets for EXPOSURE.
F1:GAIN, F2:SHUTTER, F3:IRIS, USER1:EXPOSURE, USER2:STREAMING
- 8 [WHITE BALANCE]**
Tap the button to activate the presets for WHITE BALANCE.
F1:WB R, F2:WB B, F3:NONE, USER1:WB, USER2:AWB TRIGGER
- 9 [SETTINGS]**
Tap the button to display the SETTINGS screen.
- 10 [ENTER]**
Appears when the unit goes into [STORE] mode or [DELETE] mode. Can be used to confirm and delete the position number.
- 11 [VIEW]**
Tap the button to enter [VIEW] mode.
- 12 [STORE]**
Tap the button to enter [STORE] mode.
- 13 [DELETE]**
Tap the button to enter [DELETE] mode.
- 14 [PT ACTIVE]**
Tap the button to switch [PT ACTIVE] on and off. Switching to off disables the pan/tilt operation by the control lever.
- 15 [Position Group] display**
Displays the number of the position group currently selected.
- 16 [CAM Group] display**
Displays the number of the camera group currently selected.
- 17 [Position Group] tab**
Tap to switch to the selection of position group number.
- 18 [CAM Group] tab**
Tap to switch to the selection of camera group number.
- 19 [Position] tab**
Tap to switch to the selection of position number.
- 20 Position/ position group/ camera group number buttons**
Allows you to select the position/ position group/ camera group number.
- 21 Camera number button**
Allows you to select the camera number.

Preparations

1 Set the power switch to “On”.

- The power is turned on and the POWER lamp lights up.
- The start screen is displayed on the operation panel. The ALARM lamp lights up at the same time. During which, this unit cannot be operated.
- The start screen disappears after about 10 seconds and the home screen is displayed.

2 Configure the settings of this unit.

- Set the IP address of this unit as follows.
 - ① Select [SETTINGS] on the home screen of the operation panel.
 - If the home screen does not appear, select [HOME] to display the home screen.
 - ② Select [Network].
 - ③ Select [CONTROLLER].
 - The IP address setting screen appears.
 - ④ Enter the IP address and tap [ENTER].

3 Configure the camera settings.

- Configure the camera to be operated as follows.
 - ① Select [SETTINGS] on the home screen of the operation panel.
 - If the home screen does not appear, select [HOME] to display the home screen.
 - ② Select [Network].
 - ③ Select [CAMERA REGISTRATION].
 - ④ Select [AUTO] to register the camera.

Memo : _____

- For details on configuring using the [MANUAL] setting, please refer to “Registering the IP Address” (P 22).

- To add or change the camera to be operated, perform the above procedures again.

Selecting and Operating a Camera

Selecting a Camera

Specify the camera number to display the video on the monitor.



- 1 Display the home screen.**
If the home screen does not appear, tap the [HOME] button on the screen.
- 2 Tap the number button corresponding to the number of the camera group to be operated.**
The number of the camera group selected is displayed at the upper right corner of the screen.
- 3 Tap the number button corresponding to the number of the camera to be operated.**
 - The number button of the camera selected changes color.
 - The digit of the number with non-existent camera within the camera group is displayed in white.

Memo : _____

- Up to 10 cameras can be configured to one camera group.
- Up to 10 camera groups can be registered and a total of up to 100 cameras can be configured.

Operating a Camera

Operating the PTZ (pan/ tilt/ zoom)

- 1 Select a camera to operate.**
(☞ P13 “Selecting a Camera”)
- 2 Tilt the control lever toward the direction you want the camera to move (pan/ tilt operation).**
 - Tilt the lever to the left and right to move horizontally (pan) and tilt it up and down to move vertically (tilt).
 - To change the camera movement speed, operate the [F1]/[F2] knobs.
(☞ P14 “Changing an Assigned Function”)
 - The movement speed changes depending on the tilt angle of the lever.
- 3 Operate the zoom lever to adjust the size of the field of view (zoom operation).**
 - Press the T-end of the lever to magnify the subject (Telephoto) and press the W-end to make the subject appear smaller (Wide-angle).
 - The zoom speed changes according to the extent the zoom lever is being pushed.
 - By configuring “ZOOM” to the F3 function, the control lever can be rotated to perform zoom operation.
(☞ P14 “Changing an Assigned Function”)
 - The zoom movement speed changes depending on the angle of rotation of the lever.

Performing focus operation

- 1 Turn the focus knob.**
 - To adjust the focus by turning the focus knob, set focus to “MANUAL” using the [USER1]/ [USER2] buttons.
Turn counterclockwise: Focus on near objects.
Turn clockwise : Focus on distant objects.

One push focus

Focus is automatically adjusted when you press the focus knob while focus has been set to “MANUAL”.

Recording Video to the Camera

- 1 Select USER1 on the operation panel.**
- 2 Select “REC” in function select and tap the [ENTER] button.**
- 3 Tap the USER1 button to start the recording on the camera.**
- 4 Tap the USER1 button during recording to stop the recording on the camera.**

Memo : _____

- You can also configure “REC” to the USER2 button.
- “RECORDING” appears on the operation panel during recording.
- If the recording does not start even after tapping the USER1 button, check the camera setup.

Changing an Assigned Function



Functions assigned to F1/ F2/ F3/ USER1/ USER2 can be changed.

The following procedure is to assign “FOCUS” to F1 knob.

- 1 Select F1 on the operation panel.
- 2 Select “FOCUS” in function select.
- 3 Select USER1 on the operation panel.
- 4 Select “FOCUS (AUTO/MANU)” in function select. You can switch between “AUTO” and “MANUAL” focus using the USER1 button. Setting focus to “MANUAL” allows you to adjust the focus using the F1 knob.
- 5 Tap the [ENTER] button. Tapping the [ENTER] button confirms the selected setting and returns the display to HOME screen. Tapping the [HOME] button cancels the selected setting and returns the display to HOME screen.

Memo :

- The assignable functions to each button are as follows.

	F1/F2	F3	USER1/ USER2
WB R/B	✓		
AE level	✓		
SPEED	✓		
SHUTTER	✓		
GAIN	✓		
IRIS	✓	✓	
FOCUS	✓	✓	✓
DETAIL	✓		
NONE		✓	
ZOOM		✓	
EXPOSURE			✓
WHITE BALANCE			✓
AWB TRIGGER			✓
STREAMING			✓
REC			✓

Selecting the Position

Position

This system allows you to configure multiple shooting positions on one camera. This shooting position is referred to as “position”. The JVC HD PTZ REMOTE CAMERA KY-PZ100 network camera allows you to configure 10 groups by 10 patterns, a total of 100 shooting positions. The shooting positions configured are registered as “preset positions” and can be called up any time.

Selecting a preset position

Specify a preset number to display the video of the preset position.

- 1 Select the Position Group tab and tap a group number.
- 2 Select the Position tab and tap a preset number.
- 3 Display the video of the preset number selected.

Registering a position

- 1 Display the home screen. If the home screen does not appear, tap the [HOME] button on the screen.
- 2 Tap the [STORE] button.
- 3 Tap the Position Group tab and select a group number.
- 4 Tap the Position tab.
- 5 Select the number to be registered and tap the [ENTER] button. The current camera status is registered to the selected position number of the position group.

Memo :

- The digit of the button registered with a position turns yellow.
- The digit of the position group turns yellow if positions are registered.

Deleting a registered position

- 1 Display the home screen. If the home screen does not appear, tap the [HOME] button on the screen.
- 2 Tap the [DELETE] button.
- 3 Tap the Position Group tab and select a group number.
- 4 Tap the Position tab.
- 5 Select the position number to be deleted and tap the [ENTER] button. The registration information of the selected position number of the position group is deleted.

Memo :

- The digit of the button with the position deleted turns white.
- The digit of the position group turns white when all positions are deleted.

Adjusting the Camera Functions

Adjusting the White Balance (R/B Gain)

Changing the white balance setting

You can switch among “FAW”/ “AWB”/“3200K”/ “5600K”/ “MANUAL” using the USER1 button.

- FAW : Activates automatic white balance mode.
- AWB : Automatically adjusts the white balance by tapping the AWB Trigger button.
- 3200K : Sets the color temperature to 3200K.
- 5600K : Sets the color temperature to 5600K.
- MANUAL : Manually adjust the R gain and B gain.

- 1 Select USER1 on the operation panel.
- 2 Select “WHITE BALANCE” in function select and tap the [ENTER] button.
F1 knob can be used for WB R (R gain), F2 knob for WB B (B gain), USER1 button for WB and USER2 button for AWB TRIGGER.

Executing AWB Trigger

Effective if white balance mode is set to “AWB”.
The white balance is automatically adjusted when the AWB Trigger button is tapped.

Adjusting the R/B gain

Adjust the AWB Gain within the ± 32 range if white balance mode is set to “AWB”.
Adjust the R/B GAIN in the 0 to 255 range if white balance mode is set to “MANUAL”.

Adjusting Exposure Mode (EXPOSURE)

Select method for controlling the brightness.

- AUTO : Adjusts the brightness automatically.
- SHUTTER : Switches to shutter priority (manual for shutter and auto for all others) operation.
- IRIS : Switches to iris priority (manual for iris and auto for all others) operation.
- MANUAL : Switches iris, gain and shutter to manual operation.

Adjusting the iris

- Auto iris (automatic adjustment) mode
Auto iris (automatic adjustment) mode is activated by setting EXPOSURE to “AUTO” or “SHUTTER”.

- 1 Select USER1 on the operation panel.
- 2 Select [EXPOSURE] in function select and tap the [ENTER] button.
- 3 Tap the USER1 button and select “AUTO” or “SHUTTER”.

- Manual iris (manual adjustment) mode
Manual iris (manual adjustment) mode is activated by setting EXPOSURE to “IRIS” or “MANUAL”.

- 1 Select USER1 on the operation panel.
- 2 Select [EXPOSURE] in function select and tap the [ENTER] button.
- 3 Tap the USER1 button and select “IRIS” or “MANUAL”.
- 4 Select F1 on the operation panel.
- 5 Select [IRIS] in function select and tap the [ENTER] button.
The F1 knob can be used to adjust the iris.

Setting the electronic shutter

- Automatic shutter mode (automatic shutter adjustment)
Automatic shutter mode (automatic shutter adjustment) is activated by setting EXPOSURE to “AUTO” or “IRIS”.

- 1 Select USER1 on the operation panel.
- 2 Select [EXPOSURE] in function select and tap the [ENTER] button.
- 3 Tap the USER1 button and select “AUTO” or “IRIS”.

- Manual shutter mode (manual shutter switching)
Manual shutter mode (manual shutter switching) is activated by setting EXPOSURE to “SHUTTER” or “MANUAL”.

- 1 Select USER1 on the operation panel.
- 2 Select [EXPOSURE] in function select and tap the [ENTER] button.
- 3 Tap the USER1 button and select “SHUTTER” or “MANUAL”.
- 4 Select F1 on the operation panel.
- 5 Select [SHUTTER] in function select and tap the [ENTER] button.
The F1 knob can be used to adjust the shutter.

Setting the gain

- Automatic gain mode (automatic gain adjustment)
Automatic gain mode (automatic gain adjustment) is activated by setting EXPOSURE to "AUTO".

- 1 Select **USER1** on the operation panel.
- 2 Select **[EXPOSURE]** in function select and tap the **[ENTER]** button.
- 3 Tap the **USER1** button and select "AUTO".

- Manual gain mode (manual gain switching)
Manual gain mode (manual gain switching) is activated by setting EXPOSURE to "MANUAL".

- 1 Select **USER1** on the operation panel.
- 2 Select **[EXPOSURE]** in function select and tap the **[ENTER]** button.
- 3 Tap the **USER1** button and select "MANUAL".

| Adjusting the Brightness

- Adjusting the brightness automatically (automatic brightness adjustment (AE) mode)
Automatic brightness adjustment (AE) mode is activated by setting EXPOSURE to "AUTO".

- 1 Select **F1** on the operation panel.
- 2 Select "AE LEVEL" in function select and tap the **[ENTER]** button.
- 3 Adjust the brightness for automatic brightness adjustment mode using the **F1** knob.

- Adjusting the brightness manually
Manual adjustment mode is activated by setting EXPOSURE to "MANUAL".

- 1 Select **F1** on the operation panel.
- 2 Select "AE LEVEL" in function select and tap the **[ENTER]** button.
- 3 Adjust the shutter speed using the **F1** knob.

- Memo : _____
- You can also configure "GAIN" and "IRIS" to the F1 knob.
 - "SHUTTER", "GAIN" and "IRIS" can be configured to F2 knob.
 - "IRIS" can be configured to F3 (control lever).
 - If EXPOSURE is set to "SHUTTER", only the shutter speed can be adjusted manually.
 - If EXPOSURE is set to "IRIS", only the iris can be adjusted manually.
-

| Setting the Camera Image Quality (Detail)

- 1 Select **F1** on the operation panel.
- 2 Select "DETAIL" in function select and tap the **[ENTER]** button.
- 3 Adjust the camera image quality (contour enhancement level) using the **F1** knob.

- Memo : _____
- You can also configure "DETAIL" to the F2 knob.
-

Starting the Streaming

- 1 Select **USER1** on the operation panel.
- 2 Select "STREAMING" in function select and tap the **[ENTER]** button.
- 3 Tap the **USER1** button to start streaming.
- 4 Tap the **USER1** button during streaming to stop streaming.

- Memo : _____
- You can also configure "STREAMING" to the USER2 button.
 - A streaming icon is displayed on the operation panel during streaming.
 - If streaming does not start even after tapping the USER1 button, check the camera setup.
-

Setup Flow

When setting up the system for the first time, or when new cameras are added, set up in the manner as follows. Be sure to perform an operation check after the setup.

1 IP address settings

Configure the IP address of the connected device.
(☞ P22 “IP Setup”)

2 Camera setup

Set up the connected camera.
(☞ P23 “Camera Settings Menu”)

3 Remote control settings

Configure the functions assigned to the customized buttons of this unit.
(☞ P14 “Changing an Assigned Function”)

Basic Operations of Menu Screen

- 1 Tap the [SETTINGS] button on the home screen.
The settings menu appears.
- 2 Select the item to be configured.

| Settings Menu

- VIDEO
Allows you to switch the video outputs of the connected cameras on or off.
(☞ P21 “Switching the Camera Video Output On/Off”)
 - MENU Control
Allows you to display and operate the settings menu of the selected camera.
(☞ P23 “Camera Settings Menu”)
 - Function
Allows you to configure the settings for this unit.
 - Touch Screen Volume
Allows you to configure the operation sound of the operation panel.
 - Brightness
Allows you to configure the brightness of the operation panel.
 - Power Save
Allows you to configure the duration of time before this unit enters into power save mode.
Power save mode is disabled while the settings menu is displayed.
 - Default Setting
Allows you to restore the default settings of this unit.
When the [Default Setting] button is tapped, the color of the button changes to yellow. Tap the [ENTER] button in this condition and then turn off the power to restore the default settings.
 - Setting Data<->USB
Allows you to write the settings of this unit to a USB drive and vice versa.
Connect the USB drive to the SERVICE terminal on the rear panel of this unit.
- Memo : _____
- Format the USB drive with FAT32/16 in advance. This unit does not support formatting.
-
- Version Information
The version of this unit is displayed at the bottom right of the Function screen.
- Network
Allows you to configure settings related to the network.
(☞ P22 “Network Settings on This Controller”)
 - Touch Screen
Allows you to calibrate the operation panel.
Tapping the [Touch Screen] button displays the adjustment screen. Operate according to the on-screen instructions.

Menu Screen Flow

■ The menu screens consist of normal menu screen and settings menu screen. The flow of the each screen is as shown in the figures below.

| Normal Menu Screen

VIEW Screen

Allows you to select the camera and the preset position of the camera.

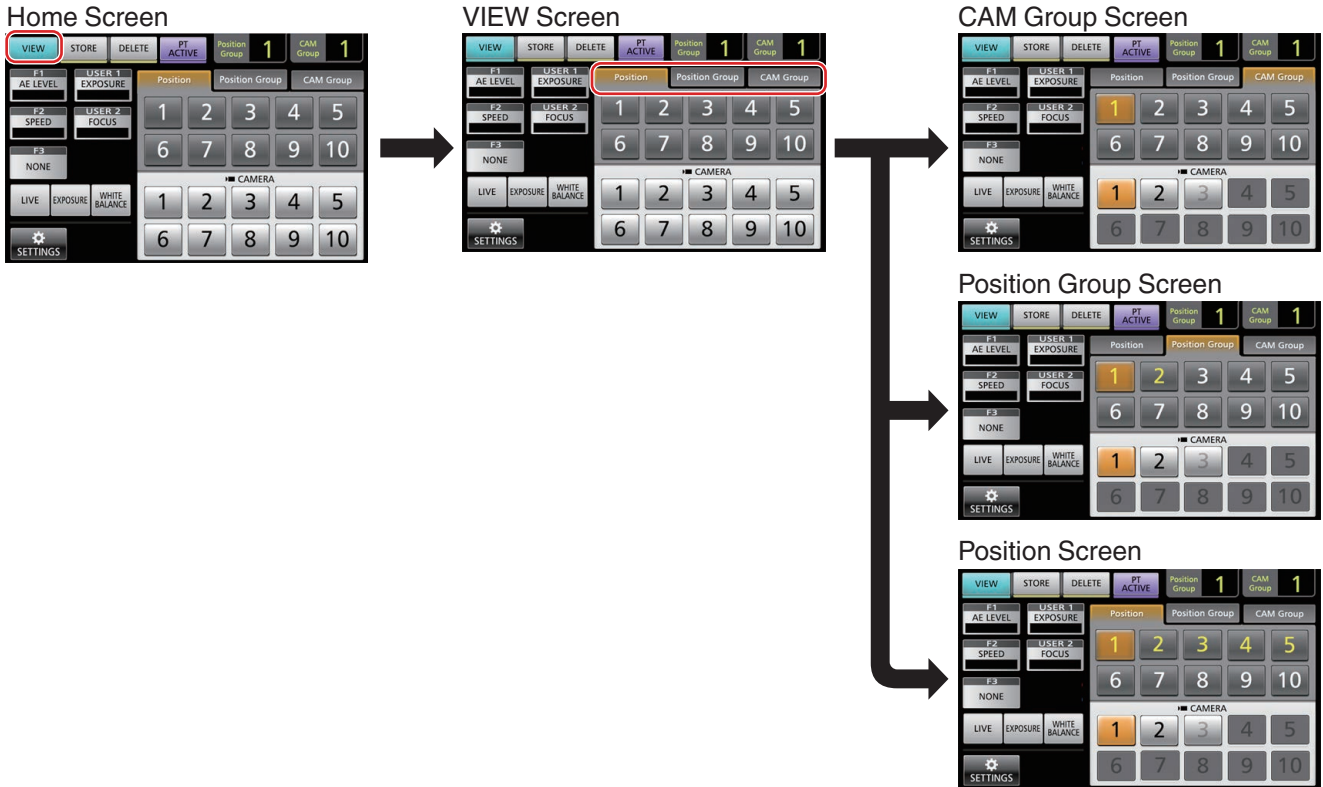

STORE Screen

Allows you to register the preset position of the camera.

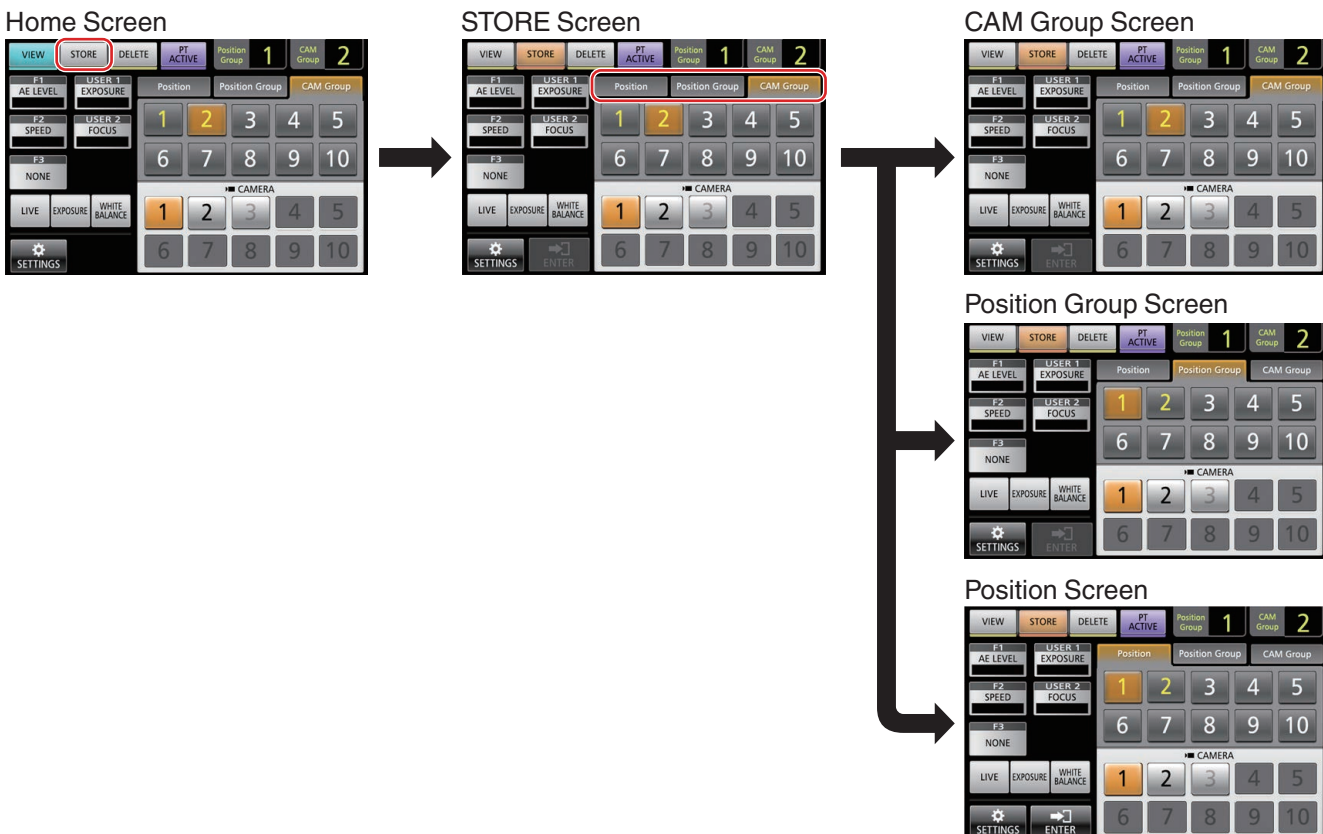

DELETE Screen

Allows you to delete the preset position of the camera.

Home Screen



DELETE Screen



CAM Group Screen



Position Group Screen



Position Screen



F1/F2/F3/USER1/USER2 Screen

For assigning functions to the buttons and knobs of this unit.

Home Screen



F1/F2 Screen (*)



F3 Screen (*)

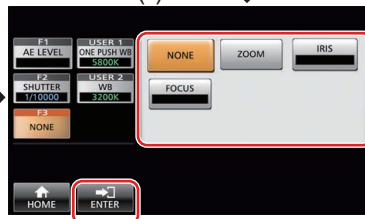

USER1/USER2 Screen (*)

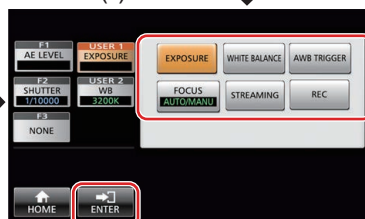

Home Screen



* You can adjust the function that is highlighted without tapping [ENTER] while the screen is displayed.

| Settings Menu Screen

SETTINGS Screen

For configuring the settings of this unit.
(P17 "Settings Menu")

Settings

Home Screen



SETTINGS Screen

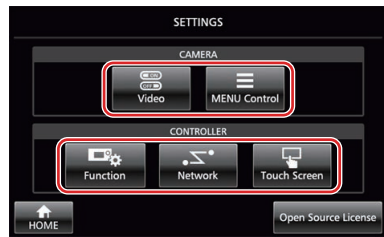

Video Screen

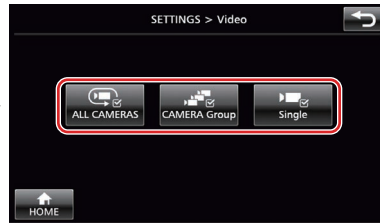

MENU Control Screen

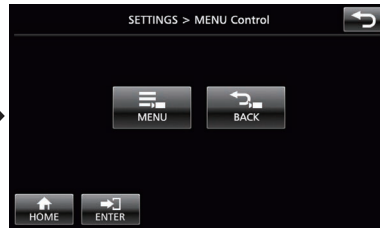

Function Screen

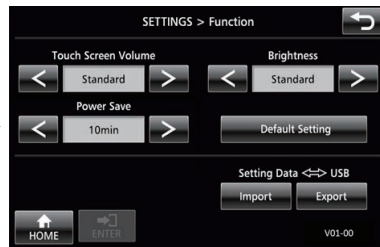

Network Screen

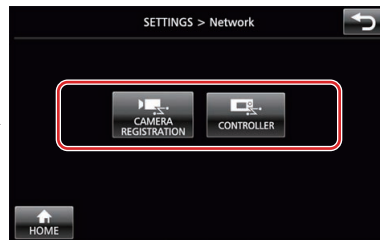

Touch Panel Screen

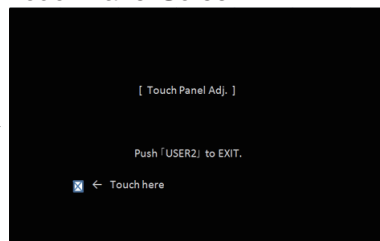

ALL CAMERAS Screen

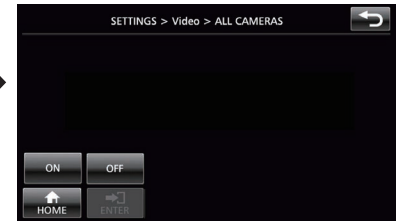

CAMERA Group Screen



Single Screen



CAMERA Screen



CONTROLLER Screen

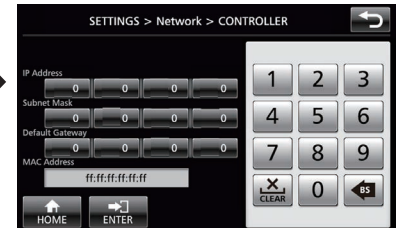

System Setup

| Switching the Camera Video Output On/Off

Setting the video outputs of all cameras on/off

- 1 Display the home screen.**
If the home screen does not appear, tap the [HOME] button on the screen.
- 2 Tap the [SETTINGS] button.**
The settings menu screen appears.
- 3 Tap the [Video] button.**
- 4 Tap the [ALL CAMERAS] button.**
- 5 Tap the [ON] or [OFF] button.**
 - Tapping the button changes the button color.
 - Tap the [ON] button to set the video output of the camera to on.
Tap the [OFF] button to set the video output of the camera to off.
- 6 Tap the [ENTER] button to confirm the setting.**

Setting the video outputs of camera groups on/off

- 1 Display the home screen.**
If the home screen does not appear, tap the [HOME] button on the screen.
- 2 Tap the [SETTINGS] button.**
The settings menu screen appears.
- 3 Tap the [Video] button.**
- 4 Tap the [CAMERA Group] button.**
- 5 Tap the number button of the camera group and the number button of the camera to be configured.**
 - Multiple camera groups can be selected.
 - The digit of the number with non-existent camera within the camera group is displayed in white.
- 6 Tap the [ON] or [OFF] button.**
 - Tapping the button changes the button color.
 - Tap the [ON] button to set the video output of the camera to on.
Tap the [OFF] button to set the video output of the camera to off.
- 7 Tap the [ENTER] button to confirm the setting.**

Setting the video output of individual camera on/off

- 1 Display the home screen.**
If the home screen does not appear, tap the [HOME] button on the screen.
- 2 Tap the [SETTINGS] button.**
The settings menu screen appears.
- 3 Tap the [Video] button.**
- 4 Tap the [Single] button.**
- 5 Tap the number button of the camera group and the number button of the camera to be configured.**
- 6 Tap the [ON] or [OFF] button.**
 - Tapping the button changes the button color.
 - Tap the [ON] button to set the video output of the camera to on.
Tap the [OFF] button to set the video output of the camera to off.
- 7 Tap the [ENTER] button to confirm the setting.**

Memo : _____

- Only cameras in the selected camera group can be configured.
- [ALL CAMERAS] can be configured to "ON"/"OFF" only for cameras within the same network.
- To control the Video output of a camera that is not within the same network, use CAMERA Group or Single.
- When the video output of a camera is turned off, you will not be able to control the camera.

IP Setup

Registering the IP Address



- 1 Display the home screen.**
If the home screen does not appear, tap the [HOME] button on the screen.
- 2 Tap the [SETTINGS] button.**
The settings menu screen appears.
- 3 Tap the [Network] button.**
- 4 Tap the [CAMERA REGISTRATION] button.**
- 5 Tap the [AUTO] or [MANUAL] button.**
 - Tapping the [AUTO] button automatically configures the camera network settings. (Recommended)
After the "Completed" message is displayed, tap the [CLOSE] button to complete the configuration.
The subsequent operation procedures are not required.Tapping the [MANUAL] button displays the manual settings screen for IP address.
- 6 Register the IP address manually.**
 - Change the [CAM Group] and [CAM No] to select the camera that you want to register the IP address.
 - Enter the IP address using the numeric keypad.
 - Tap the [ENTER] button to confirm the numbers entered.
 - Configure all the cameras to be registered using the same procedures.

Memo : _____

- This is a function to register the IP address of the camera to this unit. The IP address of the camera unit cannot be changed even when performing manual registration by selecting [MANUAL].
- Use the same Port No. and Password as configured on the connected camera.
The factory default is configured according to the factory default setting of the JVC "KY-PZ100" network camera.
- If configuring using "AUTO", this unit assigns IP addresses to the connected devices within the network in sequence from "****.***.***.100". And there are no functional problems even when the IP address of the device is duplicated.
- If more than one of this unit is connected within the same network, only up to five units can assign IP address using "AUTO".
- Configuring the IP address to "0.0.0.0" deletes the registration of that camera.

Network Settings on This Controller



- 1 Display the home screen.**
If the home screen does not appear, tap the [HOME] button on the screen.
- 2 Tap the [SETTINGS] button.**
The settings menu screen appears.
- 3 Tap the [Network] button.**
- 4 Tap the [CONTROLLER] button.**
The network settings screen of this unit appears.
- 5 Enter each item and tap the [ENTER] button.**

Memo : _____

- The default IP address of this unit is 192.168.0.2.

Tally Setup

Tally Control Interface

Configure the pin 4 and pin 5 functions of the tally terminal using the SETTING switch on the rear panel. Other than pin 4 and pin 5, the remaining pin functions cannot be changed.

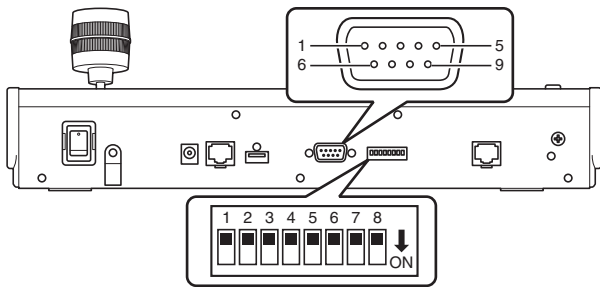

Memo :

- If a camera has been selected to receive tally signals, the button corresponding to the camera appears like **1**.

Configuration method

Tally terminal pin number	Function	SETTING switch
1	INPUT-1	-
2	INPUT-2	-
3	INPUT-3	-
4	INPUT-4	
	OUTPUT-5	
5	INPUT-5	
	OUTPUT-4	
6	GND	-
7	OUTPUT-1	-
8	OUTPUT-2	-
9	OUTPUT-3	-

Memo :

- The tally input or tally output supports camera number 1 to 5 of camera group 1. To use the tally input or tally output, assign the cameras to these numbers. For details on the tally input and tally output, refer to the "Function" column of "Configuration method".
- Inserting and removing of the tally terminal should be performed while the power is turned off.

Connection example for TALLY OUT

Please ensure the following conditions are met.

Voltage : Maximum DC 24 V

Current : Maximum 50 mA

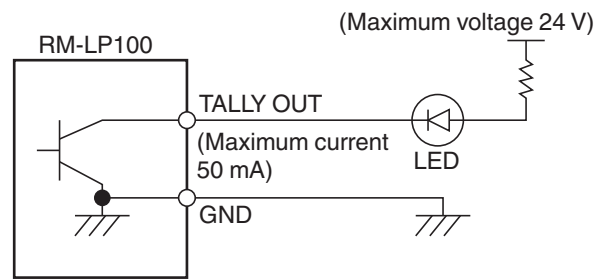

Connection example for TALLY IN

Set up the contact input.

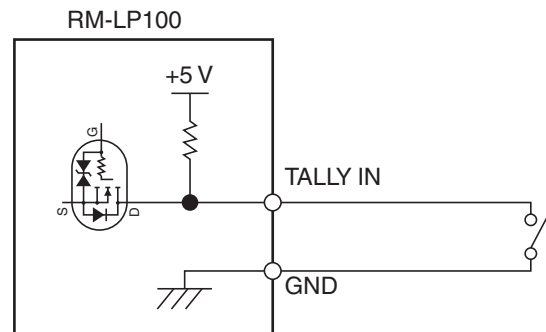

Camera Settings Menu

Making changes to the settings menu of the camera

- 1 Tap the [SETTINGS] button on the home screen of the operation panel.
 - The settings screen appears.
 - If the home screen does not appear, select [HOME] to display the home screen.
- 2 Tap the [MENU Control] button on the settings screen.
- 3 Tap the [MENU] button.
 - The settings menu of the selected camera is displayed on the video output from the camera.
 - Use the control lever and the [ENTER] button to change the settings.
- 4 Tap the [HOME] button.
 - After changing the settings, tap the [HOME] button to return to the home screen.

Memo :

- For details on making changes to the settings menu of the camera, please refer to the instruction manual of the camera.
- When removing the camera from the network, delete the camera registration as well.
- If the IP address of the camera is changed, communication may fail for a while even when the IP address has been changed through the camera registration of this unit. In that case, turn off the power.

Troubleshooting

Problem	Symptom	Action
Power does not turn on.	No response even after tapping the operation panel on the unit.	Turn off the power switch at the back of the unit and power on again. If it still does not start up, stop using the unit, disconnect the power cord from the power outlet and consult a dealer or our service center.

Others

Confirming the “OPEN SOURCE LICENSE”

- 1 **Select [SETTINGS] on the home screen of the operation panel.**
 - Tapping the button displays the [SETTINGS] screen.
 - If the home screen does not appear, select [HOME] to display the home screen.
- 2 **Select “Open Source License” on the “SETTING” screen.**
 - The “Open Source License” screen appears.

Connection Diagram

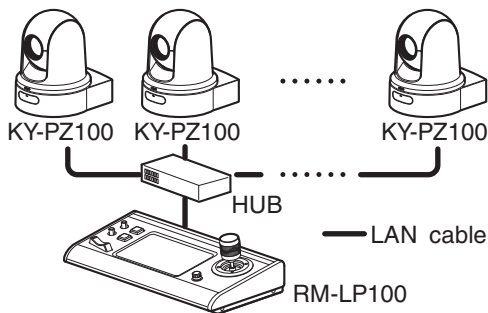

- * Up to 100 cameras can be connected concurrently.
- * Communication system of this unit
 - Normal : The TCP/destination port number is dependent on the menu settings
 - ALL CAMERAS : Multicast (239.0.255.255)/ UDP/ destination port number 80
 - CAMERA Group/ Single : UDP/ destination port number 80

Memo : _____

- “ALL CAMERAS”/“CAMERA Group”/“Single” are options for [SETTINGS] in the [Video] screen.

Specifications

| General

Item	Description
Power	DC 12 V
Current consumption	0.6 A
Mass	Approx. 2.1 kg
Surrounding temperature	0 °C to 40 °C (32 °F to 104 °F) (operation)
Allowable operating humidity	20 %RH to 90 %RH (No condensation)

| Terminal Section

Item	Description
TALLY terminal	D-sub 9-pin
LAN terminal	10BASE-T/100BASE-TX
[DC] terminal	DC jack (for the supplied AC adapter)

| Dimensional Outline Drawing (Unit: mm)

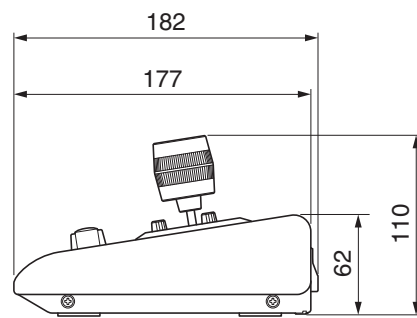
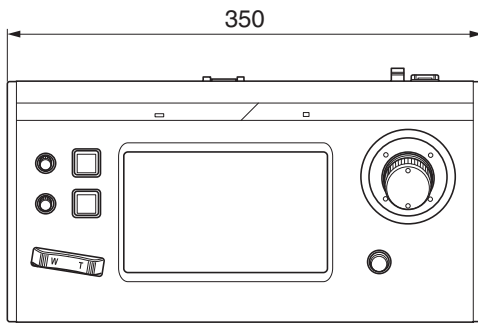

* The specifications and appearance of this product are subject to changes for further improvement without prior notice.

| Accessories

Accessories	
Warranty Card (U model only)	1
INSTRUCTIONS (BASIC)	1
AC Adapter	1
Power Cord (U model: 1, E model: 2)	
Wire Clamp	1
Screw (M3)	1

RM-LP100U/RM-LP100E
REMOTE CAMERA CONTROLLER

JVC