



USER MANUAL

MODEL:

SWT3-31-HU

3x1 4K60 USB-C/HDMI Switcher



Contents

Introduction	1
Getting Started	1
Overview	2
Typical Applications	4
Defining SWT3-31-HU 3x1 4K60 USB-C/HDMI Switcher	5
Mounting SWT3-31-HU	7
Connecting SWT3-31-HU	8
Connecting the Output to a Balanced/Unbalanced Stereo Audio Acceptor	9
Connecting to SWT3-31-HU via RS-232	10
Operating and Controlling SWT3-31-HU	11
Principles of Operation	11
Using Front and Rear Panel Buttons	14
Operating via Ethernet	14
Using Embedded Web Pages	18
Routing Signals	21
Setting AV Properties	23
Setting Device Properties	27
Setting Control Gateway Properties	34
Viewing Device Status	44
Setting Security Properties	45
Viewing the About Page	49
Upgrading Firmware	50
Technical Specifications	51
Default Communication Parameters	52
Protocol 3000	53
Understanding Protocol 3000	53
Protocol 3000 Commands	54
Result and Error Codes	68

Introduction

Welcome to Kramer Electronics! Since 1981, Kramer Electronics has been providing a world of unique, creative, and affordable solutions to the vast range of problems that confront the video, audio, presentation, and broadcasting professional on a daily basis. In recent years, we have redesigned and upgraded most of our line, making the best even better!

Getting Started

We recommend that you:

- Unpack the equipment carefully and save the original box and packaging materials for possible future shipment.
- Review the contents of this user manual.



Go to www.kramerav.com/downloads/SWT3-31-HU to check for up-to-date user manuals, application programs, and to check if firmware upgrades are available (where appropriate).

Achieving Best Performance

- Use only good quality connection cables (we recommend Kramer high-performance, high-resolution cables) to avoid interference, deterioration in signal quality due to poor matching, and elevated noise levels (often associated with low quality cables).
- Do not secure the cables in tight bundles or roll the slack into tight coils.
- Avoid interference from neighboring electrical appliances that may adversely influence signal quality.
- Position your Kramer **SWT3-31-HU** away from moisture, excessive sunlight and dust.

Safety Instructions



Caution:

- This equipment is to be used only inside a building. It may only be connected to other equipment that is installed inside a building.
- For products with relay terminals and GPIO ports, please refer to the permitted rating for an external connection, located next to the terminal or in the User Manual.
- There are no operator serviceable parts inside the unit.



Warning:

- Use only the power cord that is supplied with the unit.
- To ensure continuous risk protection, replace fuses only according to the rating specified on the product label which is located on the bottom of the unit.

Recycling Kramer Products

The Waste Electrical and Electronic Equipment (WEEE) Directive 2002/96/EC aims to reduce the amount of WEEE sent for disposal to landfill or incineration by requiring it to be collected and recycled. To comply with the WEEE Directive, Kramer Electronics has made arrangements with the European Advanced Recycling Network (EARN) and will cover any costs of treatment, recycling and recovery of waste Kramer Electronics branded equipment on arrival at the EARN facility. For details of Kramer's recycling arrangements in your particular country go to our recycling pages at www.kramerav.com/il/quality/environment.

Overview

Congratulations on purchasing your Kramer **SWT3-31-HU 3x1 4K60 USB-C/HDMI Switcher**. **SWT3-31-HU** is a high-performance auto-switcher with one USB-C and two HDMI/USB inputs and HDMI output. The connected USB peripherals, such as a room camera and microphone, are switchable for use of the active USB host, for convenient hybrid meeting operation with both room and online participants.

SWT3-31-HU provides exceptional quality, advanced and user-friendly operation, and flexible control.

Exceptional Quality

- Hybrid-meeting Collaborative Switching – Controllable coupled-signals switching of both AV and USB host inputs, for concurrent connection with AV output and space USB devices, allows collaborative hybrid meeting where multiple meeting participants are switched to share their content with both room and online meeting participants.
- HDMI Signal Switching – 4K60 4:4:4 HDMI resolution and HDCP 2.3 compliant, supporting deep color, x.v.Color™, CEC, HDMI uncompressed audio channels, Dolby TrueHD, DTS-HD, 2K, 4K, and 3D as specified in HDMI 2.0.
- USB 3.2 Switching – USB 3.2 signals switching, enables high data-rate connection between active USB host and space USB devices, such as 4K camera, high-quality audio devices, and HID (Human Interface Devices) mouse or keyboard devices.
- HDMI Mirroring – Active USB-C or HDMI input signal is mirrored to loop output port for connecting a local monitor or adding an additional unit in a daisy chain.
- I-EDIDPro™ Kramer Intelligent EDID Processing™ – Intelligent EDID handling, processing and pass-through algorithm that ensures Plug and Play operation.

Advanced and User-friendly Operation

- BYOD Ease and Convenience – Connect any DP-Alt-Mode-capable USB-C device as an AV presentation source, while providing the connected device with USB 2.0 and Ethernet connection, and (if PD-2.0-capable) up to 60 watts of power, via a single USB-C cable connection only.
- Auto Switcher Ease of Use – Automatically plays signal of the plugged source on the connected display, according to user-configured preferences, such as last-connected input.

- Display Power On/Off Control with Ease: Simply press the DISPLAY ON button to toggle on / off the power of the connected CEC-enabled display. The button's LED indicator shows you whether the display is currently powered on / off.
- Simple Control – Remote IP-controller connection, browser operation webpage, local panel buttons, or remotely connected contact-closure buttons, for easy and fully flexible user ports selection, signals routing, and switcher control.
- Comprehensive Management – Local panel status LED, remote IP-driven firmware upgrade and management via user-friendly embedded web pages, and remote IP or local serial service and management via API commands and responses communication, for flexible service options and ensure lasting, field proven deployment.

Flexible Connectivity

- Easy Online Meeting System Integrated Connectivity – Built-in flexible auto-disconnection operation of USB devices, such as room cameras and soundbars, enable detection of BYOD presenter disconnection by online meeting systems for their auto-activation, convenient integration, and ease of end-user operation according to space changing hybrid sessions needs.
- Built-in Intelligent Control Gateway - Remote IP-driven intelligent control of connected AV, USB and sensor devices via CEC, RS-232, IR or I/O. Eliminating the need for an external control gateway, this feature reduces installation complexity and costs, to enable easy integration with control systems, such as Kramer Control.
- Secured Network Connection – Standard IT-grade 802.1x authentication for secured IT LAN connectivity.
- HDMI Mirroring – Active USB-C or HDMI input signal is mirrored to loop output port for connecting a local monitor or adding an additional unit in a daisy chain.
- Audio De-embedding – The digital audio signal passing-through to the output, is de-embedded, converted to an analog signal and sent to the stereo balanced analog audio output. This enables playing the audio on a locally connected professional audio system (such as DSP) and speakers, in parallel to playing it on the speakers connected to the AV acceptor device (such as TVs with speakers).
- Easy and Elegant Installation – PoE powering via LAN port connection, and MegaTOOLS™ fan-less enclosure for dropped-ceiling mounting, or side-by-side mounting of 2 units in a 1U rack space with the recommended rack adapter, for easy switcher deployment.

Typical Applications

SWT3-31-HU is ideal for the following typical applications:

- Enterprise and education hybrid huddle spaces.
- Hybrid user connection element in advanced hybrid meeting solutions.

Controlling your SWT3-31-HU

Control your **SWT3-31-HU** directly via the front panel push buttons, or:

- Via the IP commands transmitted by a controller and touch screen system, or a browser using built-in user-friendly Web pages.
- By RS-232 serial commands transmitted by a touch screen system, PC, or a serial controller.

Defining SWT3-31-HU 3x1 4K60 USB-C/HDMI Switcher

This section defines SWT3-31-HU.

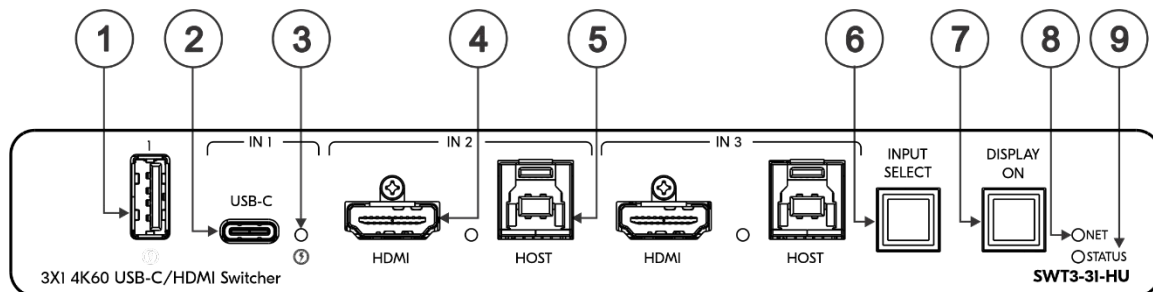

Figure 1: Figure 2: SWT3-31-HU 3x1 4K60 USB-C/HDMI Switcher Front Panel

#	Feature	Function										
①	USB Type A Port	Connect to the USB local devices (for example, a USB PTZ camera).										
②	USB-C IN 1 Port	<p>Connect to USB-C AV sources:</p> <ul style="list-style-type: none"> that support DisplayPort Alternate Mode, for example, a laptop) to share content. to communicate with the USB devices (for example, a PTZ camera) that are connected to the device, to connect to the LAN to charge the connected sources (that supports USB Power Delivery 2.0). <p>i While charging, the charging icon (to the right of the connector) becomes visible and lights orange.</p>										
③	IN Status LED 1 to 3 (per input port)	<table border="1"> <thead> <tr> <th>LED Status</th> <th>Indicates</th> </tr> </thead> <tbody> <tr> <td>Lights blue</td> <td>An input is selected and connected with an active AV or USB source.</td> </tr> <tr> <td>Flashes blue</td> <td>An input is selected and has no active AV signal.</td> </tr> <tr> <td>Off</td> <td>An input is not selected and has an active AV signal.</td> </tr> </tbody> </table>	LED Status	Indicates	Lights blue	An input is selected and connected with an active AV or USB source.	Flashes blue	An input is selected and has no active AV signal.	Off	An input is not selected and has an active AV signal.		
		LED Status	Indicates									
		Lights blue	An input is selected and connected with an active AV or USB source.									
		Flashes blue	An input is selected and has no active AV signal.									
Off	An input is not selected and has an active AV signal.											
④	HDMI	Connect to an HDMI source.										
⑤	HOST USB B 3.2 Connector	Connect to a USB host (for example, a room PC) to communicate with the USB devices (for example, a PTZ camera) connected on this device.										
⑥	INPUT SELECT Button	Press to select an input.										
⑦	DISPLAY ON Button	Press to turn display On/Off. Button LED lights on sending Display On message. Button LED turns off on sending Display Off message.										
⑧	NET LED	<table border="1"> <thead> <tr> <th>LED Status</th> <th>Indicates</th> </tr> </thead> <tbody> <tr> <td>Dark</td> <td>No IP address acquired.</td> </tr> <tr> <td>Lights green</td> <td>A valid IP address has been acquired.</td> </tr> <tr> <td>Flashes green for 60s</td> <td>A means to identify the device in a system, using command #IDV.</td> </tr> <tr> <td>Flashes red/green</td> <td>IP fallback address has been acquired.</td> </tr> </tbody> </table>	LED Status	Indicates	Dark	No IP address acquired.	Lights green	A valid IP address has been acquired.	Flashes green for 60s	A means to identify the device in a system, using command #IDV.	Flashes red/green	IP fallback address has been acquired.
		LED Status	Indicates									
		Dark	No IP address acquired.									
		Lights green	A valid IP address has been acquired.									
		Flashes green for 60s	A means to identify the device in a system, using command #IDV.									
Flashes red/green	IP fallback address has been acquired.											
⑨	STATUS LED	<table border="1"> <thead> <tr> <th>LED Status</th> <th>Indicates</th> </tr> </thead> <tbody> <tr> <td>Dark</td> <td>Power is off</td> </tr> <tr> <td>lights white</td> <td>PSU-powered on (only). Note: This is applicable when power supply is PoE mode.</td> </tr> </tbody> </table>	LED Status	Indicates	Dark	Power is off	lights white	PSU-powered on (only). Note: This is applicable when power supply is PoE mode.				
		LED Status	Indicates									
		Dark	Power is off									
lights white	PSU-powered on (only). Note: This is applicable when power supply is PoE mode.											

#	Feature	Function
		Lights blue
		Lights green

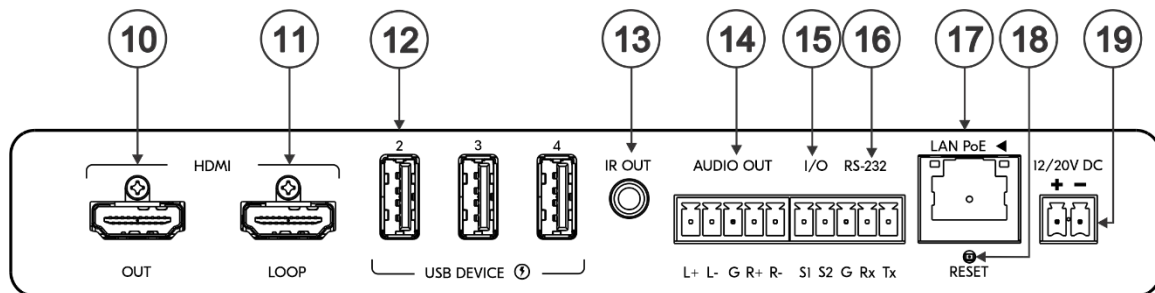

Figure 3: SWT3-31-HU 3x1 4K60 USB-C/HDMI Switcher Front Panel

#	Feature	Function
⑩	HDMI OUT Connector	Connect to an HDMI acceptor.
⑪	HDMI LOOP Connector	Connect to a local acceptor.
⑫	USB DEVICE Type A Port (2 to 4)	Connect to the USB local devices (for example, a USB camera, a soundbar, microphone and so on).
⑬	IR OUT 3.5mm Mini Jack	Outputs an IR signal, per command from LAN-connected controller (for example, from KC-VB1), to a connected IR emitter.
⑭	AUDIO OUT 5-pin Terminal Block Connector	Connect to a balanced stereo analog audio acceptor.
⑮	I/O 2-pin Terminal Block (S1 to S2)	Connect to: <ul style="list-style-type: none"> • Input-triggering devices (for example, remote buttons or sensors), OR • Output-triggered devices (for example, remote alarm LED indication). These GPIO ports may be configured as a digital input, digital output, or analog input ports.
⑯	RS-232 3-pin Terminal Block	Connect to an RS-232 controlled device (for example, the connected PTZ USB camera) to be controlled via an IP-connected controller (for example, SL-240C).
⑰	LAN PoE RJ-45 Connector	Connect to LAN. The device accepts power from the LAN port.
⑱	RESET Recessed Button	For restoring factory default settings, press the RESET button and connect power to device (keep pressing longer than 6sec after power connection)
⑲	12/20V DC Power Connector	Use the included +20V 6A power supply for powering the unit and charging the source device connected to the USB-C port, or For powering the unit, without USB-C charging support, use PoE powering or an optional +12V DC 5A power adapter (purchased separately).

Mounting SWT3-31-HU

This section provides instructions for mounting **SWT3-31-HU**. Before installing, verify that the environment is within the recommended range:



- Operation temperature – 0° to 40°C (32 to 104°F).
- Storage temperature – -40° to +70°C (-40 to +158°F).
- Humidity – 10% to 90%, RHL non-condensing.

**Caution:**

- Mount **SWT3-31-HU** before connecting any cables or power.

**Warning:**

- Ensure that the environment (e.g., maximum ambient temperature & air flow) is compatible for the device.
- Avoid uneven mechanical loading.
- Appropriate consideration of equipment nameplate ratings should be used for avoiding overloading of the circuits.
- Reliable earthing of rack-mounted equipment should be maintained.
- Maximum mounting height for the device is 2 meters.

Mount SWT3-31-HU in a rack:

- Use the recommended rack adapter
(see www.kramerav.com/product/SWT3-31-HU).

Mount SWT3-31-HU on a surface using one of the following methods:

- Attach the rubber feet and place the unit on a flat surface.
- Mount the unit in a rack using the recommended rack adapter
www.kramerav.com/downloads/SWT3-31-HU.

Connecting SWT3-31-HU

i Always switch off the power to each device before connecting it to your **SWT3-31-HU**. After connecting your **SWT3-31-HU**, connect its power and then switch on the power to each device.

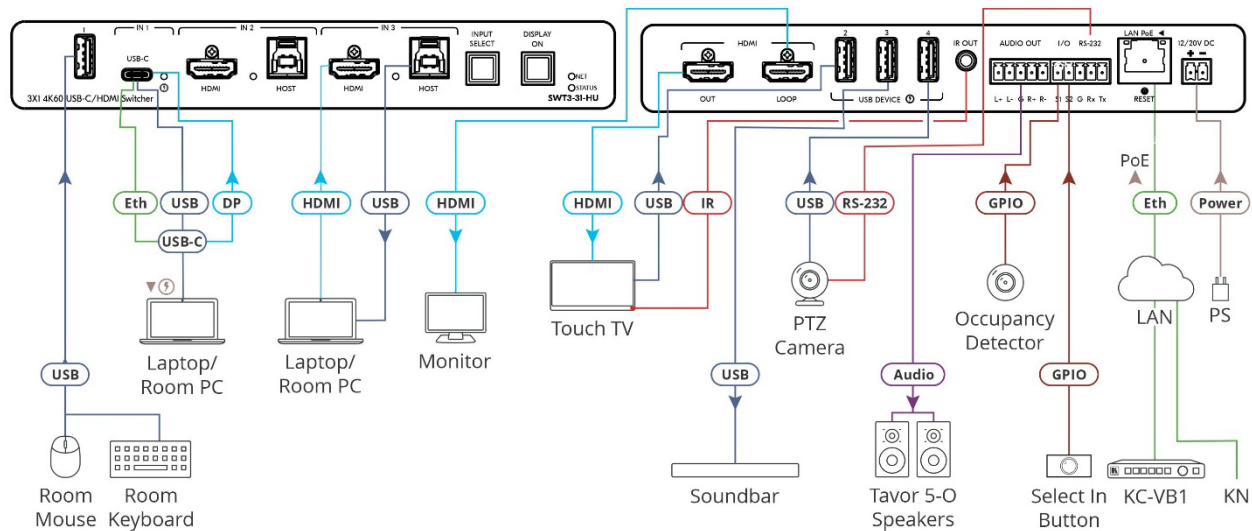

Figure 4: Connecting to the SWT3-31-HU Rear Panel

To connect SWT3-31-HU as illustrated in the example in [Figure 4](#):

1. Connect a USB-C source (for example, a laptop that supports Display Port Alternate Mode) to the USB-C IN connector (2).
2. Connect a source (for example, a room PC) to the IN 2 HDMI (4) and USB Host (5) connectors. Same for IN 3.
3. Connect the HDMI OUT port (10) to an HDMI acceptor (for example, a touch TV).
3. Connect the HDMI LOOP connector (11) to an HDMI acceptor (for example, a local monitor).
5. Connect USB DEVICE ports:

i USB devices that consume power greater than the power supplied by connected port (see Technical Specifications), should be powered by an external power supply.

- Connect the room keyboard and mouse to the USB 1 type A port (1) on the front panel.
 - Connect the touch TV to the USB 2 port (12) on the rear panel.
 - Connect a soundbar to the USB 3 port (12) on the rear panel.
 - Connect a PTZ camera to the USB 4 port (12) on the rear panel.
4. To control the touch TV via IR, connect IR OUT 3.5mm mini jack (13) to an IR emitter cable and attach the cable emitter side to the IR sensor of the touch TV.
 5. To control the PTZ camera, connect the RS-232 3-pin terminal block connector (16) to the PTZ camera.

- Connect a room controller (for example, the Kramer **KC-VB1**) via LAN to the LAN PoE Ethernet RJ-45 port (17).

Send from the room controller via LAN:

- IR commands via the room controller to control the smart TV.
 - Serial commands to control the camera.
- Connect the AUDIO OUT 5-pin terminal block connector (14) to a balanced stereo audio acceptor (for example, Kramer **Tavor 5-O** speakers).
 - Connect the IO 2-pin terminal block (15):
 - To an occupancy detector.
 - To a selector button.
 - Connect LAN connector (17) to IT switch for LAN connection and PoE powering. Optionally, connect the power adapter to **SWT3-31-HU** (19) and to the mains electricity.



To charge the device that is connected to the USB-C port, you need to use a chargeable power adapter (purchased separately) for powering the **SWT3-31-HU** switcher.

Connecting the Output to a Balanced/Unbalanced Stereo Audio Acceptor

The following are the pinouts for connecting the output to a balanced or unbalanced stereo audio acceptor:

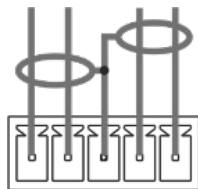

L+ L- G R+ R-

Figure 5: Connecting to a Balanced Stereo Audio Acceptor

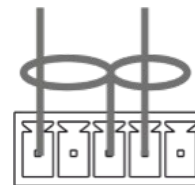

L+ L- G R+ R-

Figure 6: Connecting to an Unbalanced Stereo Audio Acceptor

Connecting to SWT3-31-HU via RS-232

You can connect to **SWT3-31-HU** via an RS-232 connection ⁽¹³⁾ using, for example, a PC.

SWT3-31-HU features an RS-232 3-pin terminal block connector allowing the RS-232 to control **SWT3-31-HU**.

Connect the RS-232 terminal block on the rear panel of **SWT3-31-HU** to a PC/controller, as follows:

From the RS-232 9-pin D-sub serial port connect:

- Pin 2 to the TX pin on the **SWT3-31-HU** RS-232 terminal block
- Pin 3 to the RX pin on the **SWT3-31-HU** RS-232 terminal block
- Pin 5 to the G pin on the **SWT3-31-HU** RS-232 terminal block

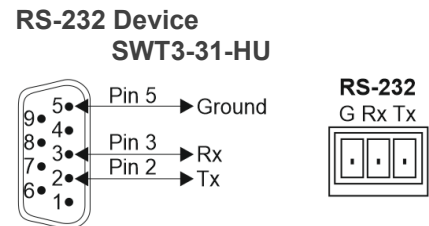

Operating and Controlling SWT3-31-HU



Principles of Operation

This section covers the following topics:

- [Coupled or Individual AV+USB Switching](#) on page [11](#).
- [Flexible SWT3-31-HU Auto Switching Policy](#) on page [11](#).
- [Flexible USB-C Mix of Signals](#) on page [12](#).
- [Online Meeting Systems Integration](#) on page [12](#).
- [Routing IP-Driven Control Signals via Built-in Control Gateway](#) on page [13](#).
- [Flexible Remote Buttons Control](#) on page [14](#).

Coupled or Individual AV+USB Switching

SWT3-31-HU multi-signal switching of any of the inputs to the AV output and connected USB devices, is configurable to use one of the following operation modes:

- USB follows AV coupled routing () – Selecting an AV input, routes the AV signal to the AV output and connects, in parallel, the input-associated USB host with the connected USB devices.
- USB signal individual routing () – Selecting an AV input, routes the AV signal to the AV output only. The USB host can be independently selected to connect with the connected USB devices (see Individual USB Host Routing).

See [Routing AV and USB Host Signals](#) on page [22](#).

This is very useful in hybrid sessions, for convenient switching between multiple presenters using either their BYOD laptops and/or connected space PC devices.

Flexible SWT3-31-HU Auto Switching Policy

Set the switching policy to:

- Manual – Select an input manually and switching occurs whether a live signal is present on the input or not.
- Auto – Auto Switching selection is performed according to either the Last Connected or the Priority policy.

In Last Connected policy:

- If a signal is plugged in this mode, **SWT3-31-HU will switch to it.**
- If the signal on the current input is lost, **SWT3-31-HU** automatically selects the last connected input.



The auto-switching delay depends on the configurable signal-lost timeout

In Priority policy:

- If a signal with a higher priority than the current one is plugged in this mode, **SWT3-31-HU** will switch to it.
- When the input sync signal is lost for any reason, the input with a live signal and next in priority is selected automatically.



The auto-switching delay depends on the configurable signal-lost timeout. Inputs priority is configurable; the default setting is HDMI 1 → HDMI 2 → HDMI 3 → HDMI 4



In both Last Connected and Priority modes, manually selecting an input (using the front panel, remote or web UI input select button) overrides automatic selection

See [Setting the Auto-Switching Policy](#) on page [23](#).

Flexible USB-C Mix of Signals

AV and USB signals mix, and their data rate level, of the USB-C host port, can be flexibly set to either one of:

- High USB 3.0 data rate and lower 4K60 4:2:0 AV resolution mix, or
- High 4K60 4:4:4 AV resolution and lower USB 2.0 data rate mix

See [Setting USB-C Host Port Signals Mix](#) on page [31](#).

Online Meeting Systems Integration

USB device ports can be set to auto-disconnect following presenter disconnection, to allow smooth integration and auto-activation of connected online meeting room systems.

See [Auto-disconnecting a USB Device on Inactive Host](#) on page [32](#).

Routing IP-Driven Control Signals via Built-in Control Gateway

Remote IP connected clients can send from the LAN, via the **SWT3-31-HU** built-in control gateway, CEC, RS-232, I/O and IR commands, and receive responses and notifications, to control devices connected to **SWT3-31-HU** HDMI-CEC, RS-232, I/O and IR control ports. The built-in control gateway sends the control commands (converted from the client received IP messages) to the connected controlled devices, and distributes the responses received from the connected controlled devices to all connected clients.

[Figure 7](#) shows the **SWT3-31-HU** built-in control gateway connection. The Kramer Control controller is connected to the switcher via LAN, sends IP commands to the switcher control gateway over the LAN connection, to send control messages to, and receive control responses from:

- The touch TV connected to the switcher via the IR and/or HDMI (CEC) ports.
- The PTZ Camera connected to the receiver via the RS-232 port.
- The Occupancy Detector & Select In Button connected to the receiver via the I/O ports.

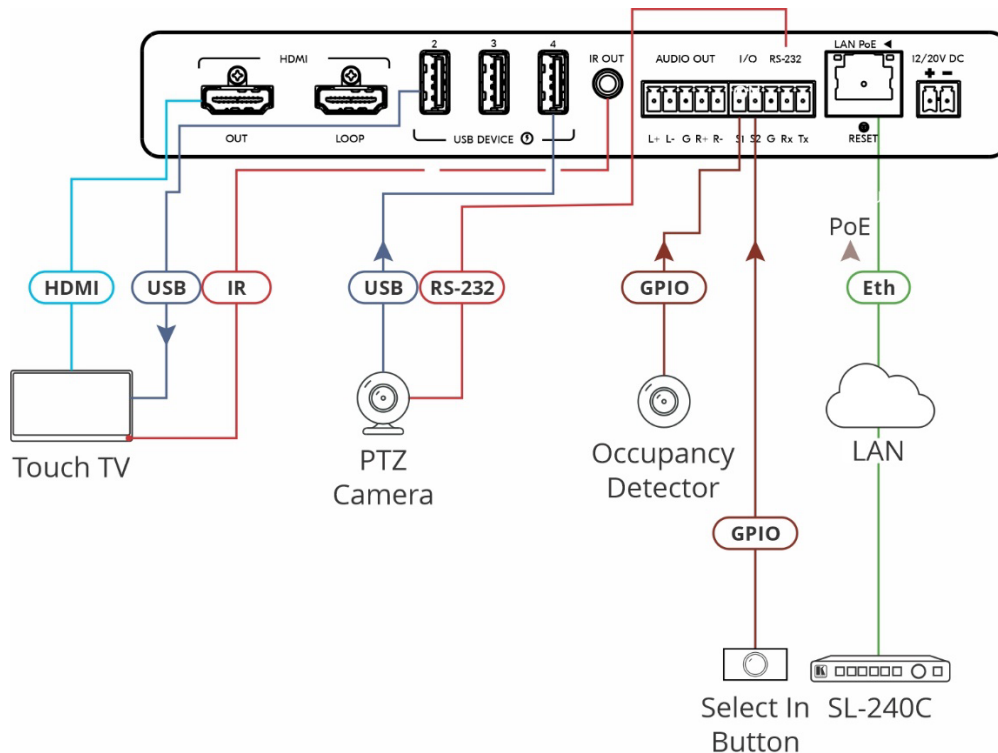

Figure 7: Controlling remotely via Control Gateway

Built-in control gateway activation, activation of the associated control ports and their attributes (such as the CEC logical address of the control gateway), as well as manual commands testing operation, is done via SWT3-31-HU control gateway webpages (see [Setting Control Gateway Properties](#) on page 34).

Flexible Remote Buttons Control

Remote contact-closure buttons can be connected to the I/O ports, for easy end user control of device functions by button press and release operation. Flexible configuration of button press/release actions and latching (default) or momentary operation mode, enable simple and custom control according to user needs.

(see [Configuring Remote Buttons](#) on page [42](#)).

Using Front and Rear Panel Buttons

SWT3-31-HU front and rear panel buttons enable the following actions:

- Selecting an INPUT.
- Turning the display on or off via the DISPLAY ON or sending on or off commands that are configured via the UI (see [Defining and Testing Commands via Action Editor](#) on page [41](#)).
- Resetting device to its factory settings (for additional instructions on resetting and resetting device (see [Resetting and Restarting Device](#) on page [28](#)).

Operating via Ethernet

You can connect to **SWT3-31-HU** via Ethernet using either of the following methods:

- Directly to the PC using a crossover cable (see [Connecting Ethernet Port Directly to a PC](#) on page [14](#)).
- Via a network switch or router, using a straight-through cable (see [Connecting Ethernet Port via a Network Switch](#) on page [16](#)).



If you want to connect via a router and your IT system is based on IPv6, speak to your IT department for specific installation instructions.

Connecting Ethernet Port Directly to a PC

You can connect the Ethernet port of **SWT3-31-HU** directly to the Ethernet port on your PC using a crossover cable with RJ-45 connectors.



This type of connection is recommended for identifying **SWT3-31-HU** with the factory configured default IP address.

After connecting **SWT3-31-HU** to the Ethernet port, configure your PC as follows:

1. Click **Start > Control Panel > Network and Sharing Center**.
2. Click **Change Adapter Settings**.

- Highlight the network adapter you want to use to connect to the device and click **Change settings of this connection**.

The Local Area Connection Properties window for the selected network adapter appears as shown in [Figure 8](#).

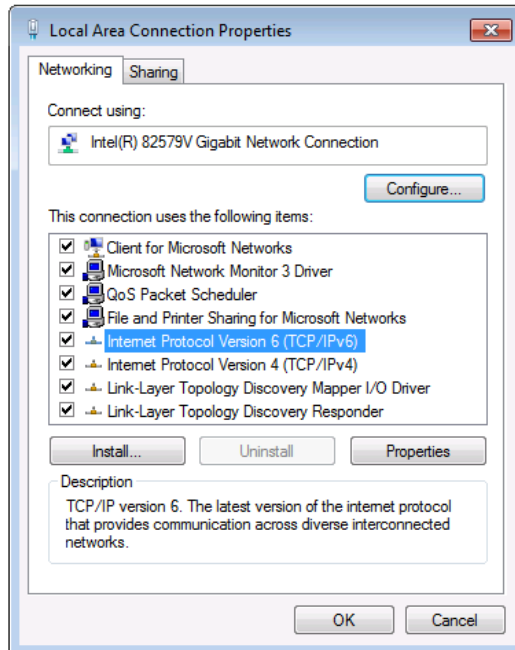

Figure 8: Local Area Connection Properties Window

- Highlight either **Internet Protocol Version 6 (TCP/IPv6)** or **Internet Protocol Version 4 (TCP/IPv4)** depending on the requirements of your IT system.
- Click **Properties**.

The Internet Protocol Properties window relevant to your IT system appears as shown in [Figure 9](#) or [Figure 10](#).

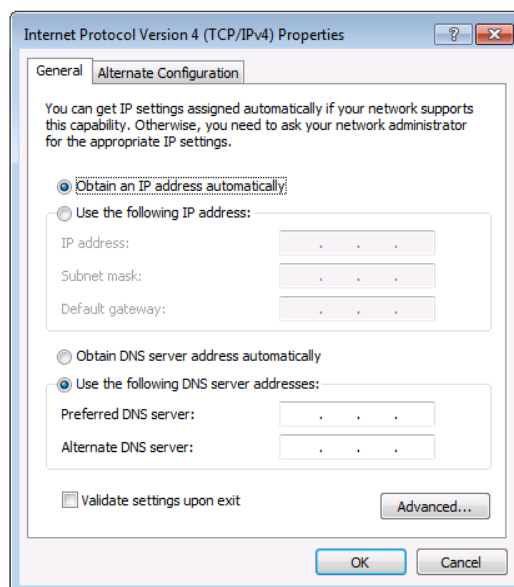

Figure 9: Internet Protocol Version 4 Properties Window

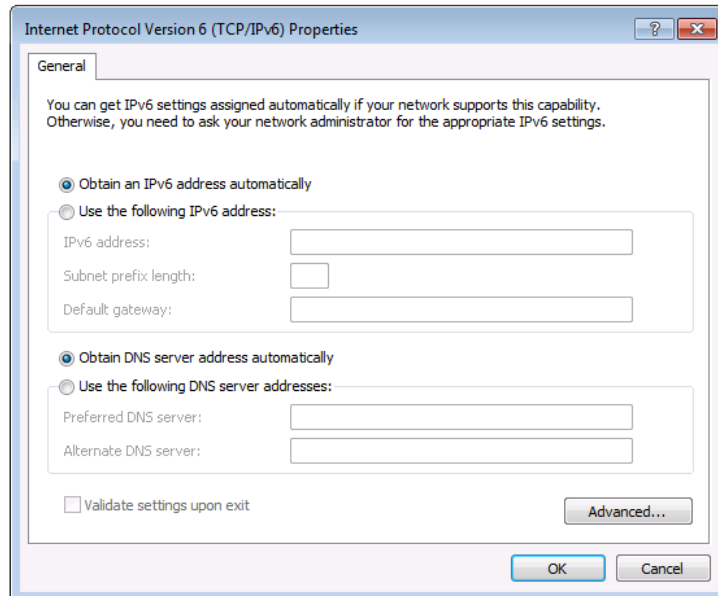

Figure 10: Internet Protocol Version 6 Properties Window

6. Select **Use the following IP Address** for static IP addressing and fill in the details as shown in [Figure 11](#).

For TCP/IPv4 you can use any IP address in the range 192.168.1.1 to 192.168.1.255 (excluding default 192.168.1.39 fallback address) that is provided by your IT department.

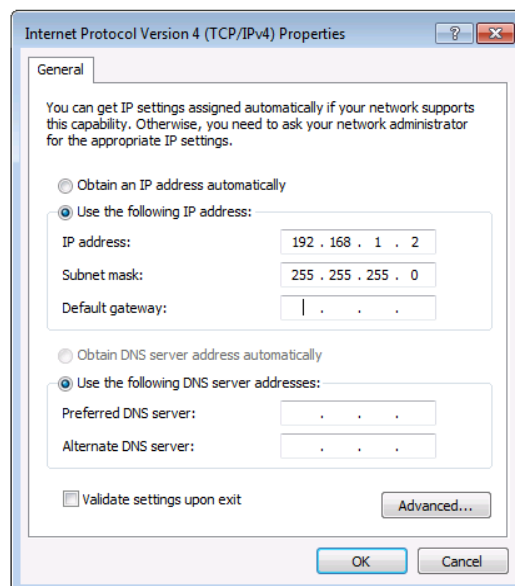

Figure 11: Internet Protocol Properties Window

7. Click **OK**.
8. Click **Close**.

Connecting Ethernet Port via a Network Switch

You can connect the Ethernet port of **SWT3-31-HU** to the Ethernet port on a network switch or router using a straight-through cable with RJ-45 connectors.

Configuring Ethernet Port

You can set the Ethernet parameters via the embedded Web pages.



Discovering and acquiring IP address

SWT3-31-HU includes IP address auto-acquiring policy via LAN-connected DHCP server by default. When no DHCP server is detected, a fallback static IP address of 192.168.1.39, and 255.255.255.0 subnet mask (class C), is assigned until an IP address is acquired via the DHCP server.

For more information, refer to Product Page Technical Note in www.kramerav.com/product/SWT3-31-HU.

Using Embedded Web Pages

SWT3-31-HU enables you to configure settings via Ethernet using built-in, user-friendly web pages. The Web pages are accessed using a Web browser and an Ethernet connection.



-  To apply the USB-C type change, device power cycle must be performed.
-  USB-C ethernet connection is disabled by default and is enabled only by API command. (see [Protocol 3000 Commands](#) on page 54).

Before attempting to connect:

- Perform the procedure in (see [Operating via Ethernet](#) on page 14).
- Ensure that your browser is supported.

The following operating systems and Web browsers are supported:

Operating Systems	Browser
Windows 10 and higher	Edge
	Chrome
Mac	Safari
iOS	Safari
Android	N/A

-  If a web page does not update correctly, clear your Web browser's cache.
-  Check that Security/firewalls are not blocking HTTP traffic between the device and the user PC.

To access the web pages:

1. Enter the IP address of the device in the address bar of your internet browser (default = 192.168.1.39).

If security is enabled, the Login window appears.

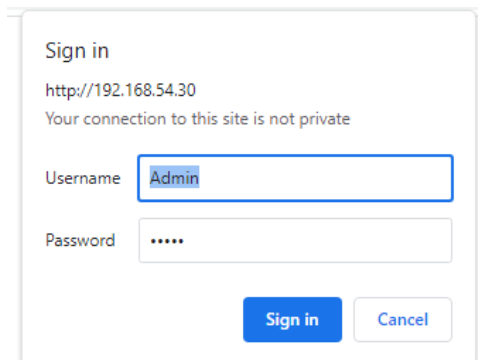

Figure 12: Embedded Web Pages Login Window

- 2. Enter the Username (default = Admin) and Password (default = Admin) and click **Sign in**. The default web page appears.

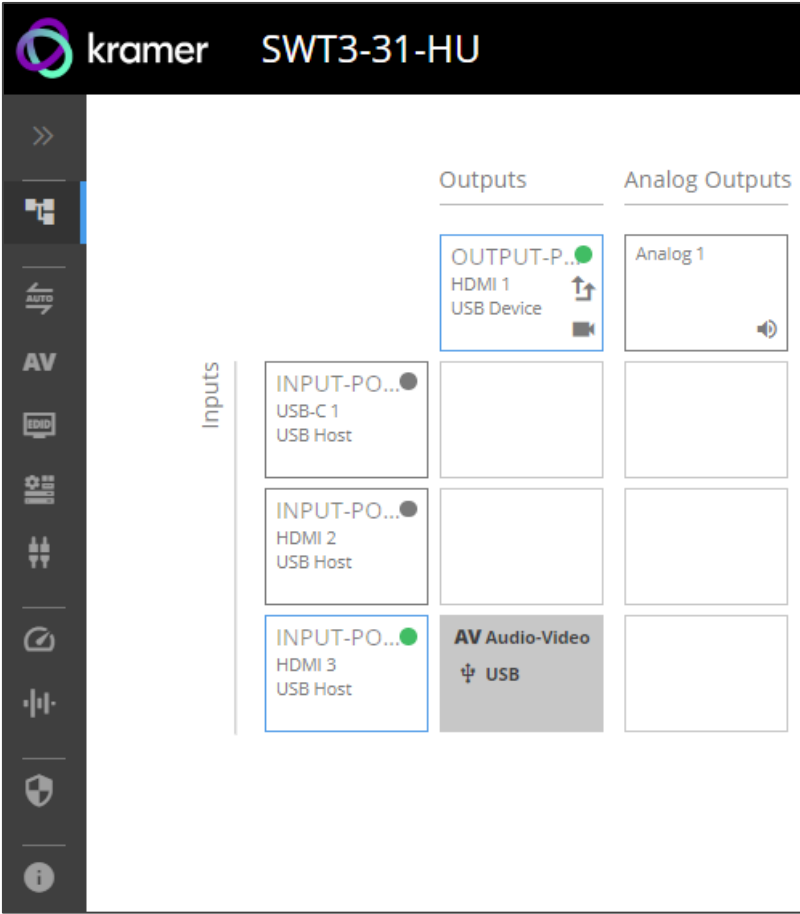

Figure 13: AV Settings Page

- Click the arrow at the top of the navigation list to view the menu items in detail.

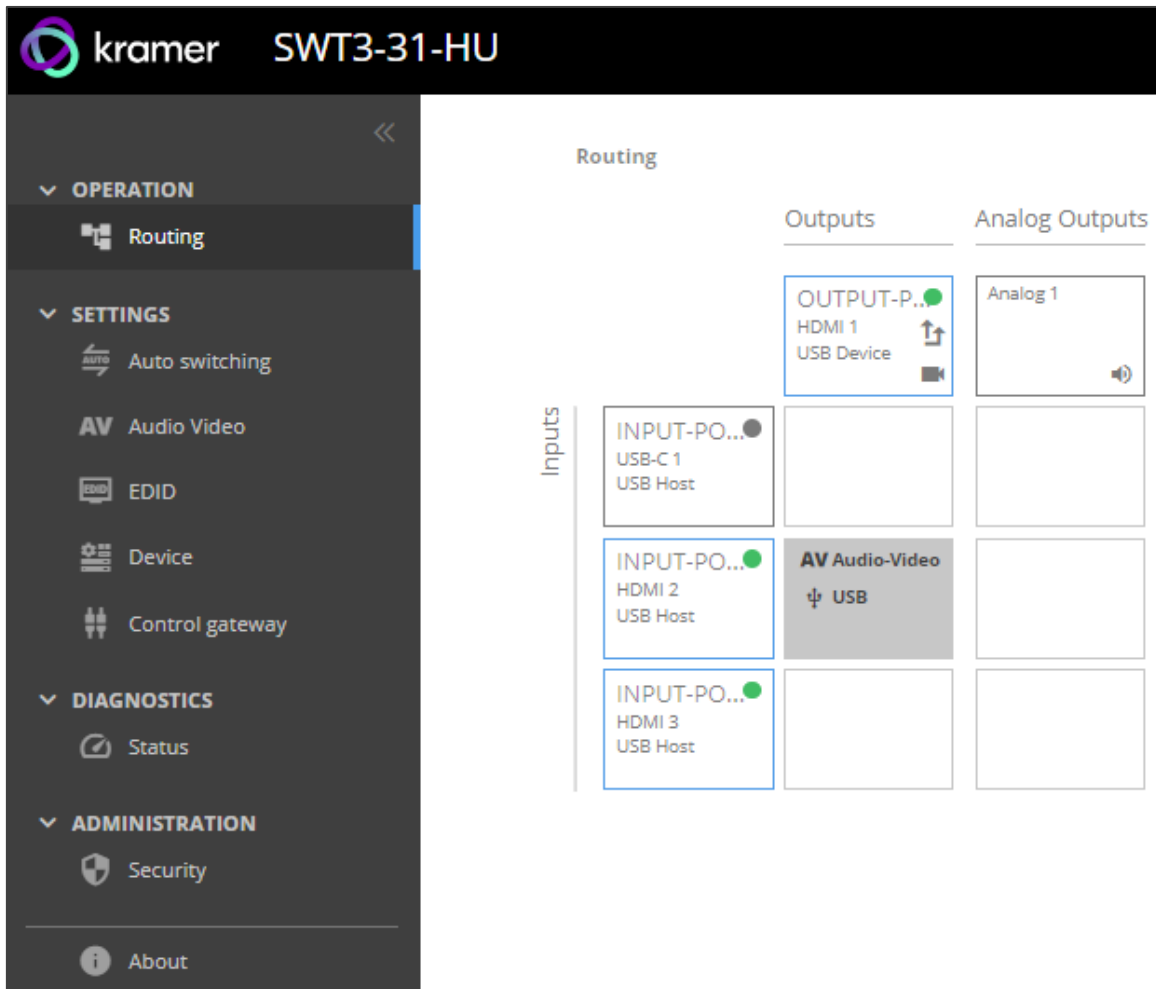

Figure 14: Navigation pane in Detail

- Click the Navigation Pane on the left side of the screen to access the relevant web page.

SWT3-31-HU web pages enable performing the following actions:

- [Routing Signals](#) on page [21](#).
- [Setting AV Properties](#) on page [23](#).
- [Setting Device Properties](#) on page [27](#).
- [Setting Control Gateway Properties](#) on page [34](#).
- [Viewing Device Status](#) on page [44](#).
- [Setting Security Properties](#) on page [45](#).
- [Viewing the About Page](#) on page [49](#).

Routing Signals

This section details the following actions:

- [Routing a Video Input to an Output](#) on page 21.
- [Setting Analog Audio Output Level](#) on page 23.

Routing a Video Input to an Output

When routing any of the inputs to the output, you can set all 3 inputs to route the AV signal together with the USB signal (USB follows video coupled routing) or to independently route each individual signal.

To route the video inputs to the outputs:

1. Go to the Routing Settings page.

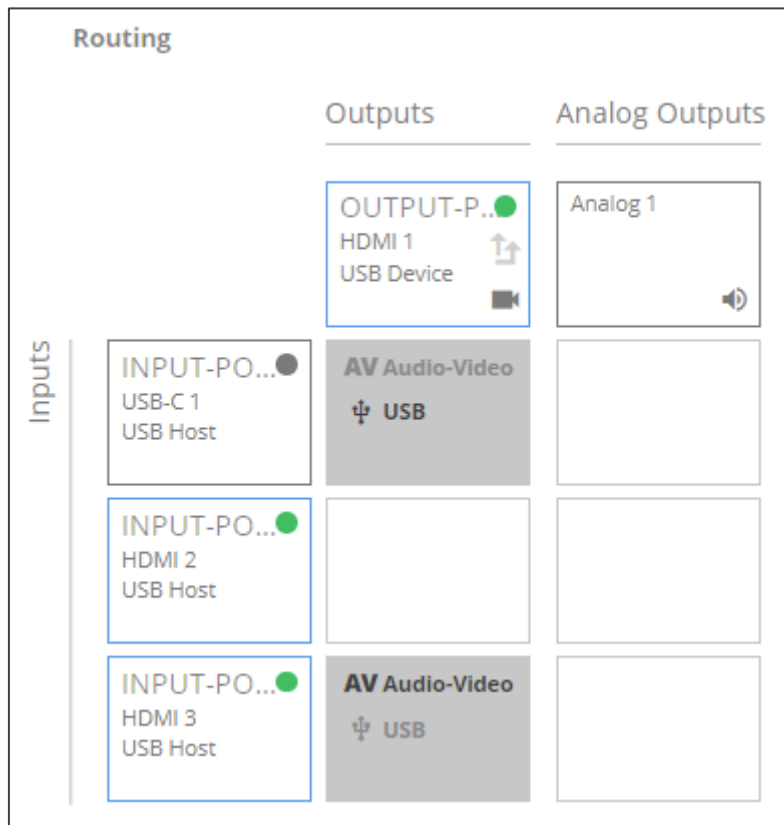



Figure 15: Routing Page

2. Perform the following functions:

- Click an Input/Output cross-point (see [Routing AV and USB Host Signals](#) on page 22).





A green light on a button indicates a connected source/acceptor.

- Click  to activate USB following video coupled routing.
- Click  to stop/play the video.

An input is routed to the output.

Routing AV and USB Host Signals

SWT3-31-HU enables switching any of the inputs to the output in one of the following operation modes:

- USB follows AV coupled routing () – Selecting an input, routes the HDMI signal to the output and associates the USB devices to that selected USB host.
- USB signal individual routing () – Selecting an input, routes the HDMI signal to the output. The USB host can be selected separately from any of the other inputs.

Individual USB Host Routing

In the following example, USB routing does not follow video, so you can individually select the AV signal on input 3 and the USB signal on input 1. This means that the HDMI input 3 AV signal is routed to the output and the USB devices are associated with the USB-C host (Input 1).

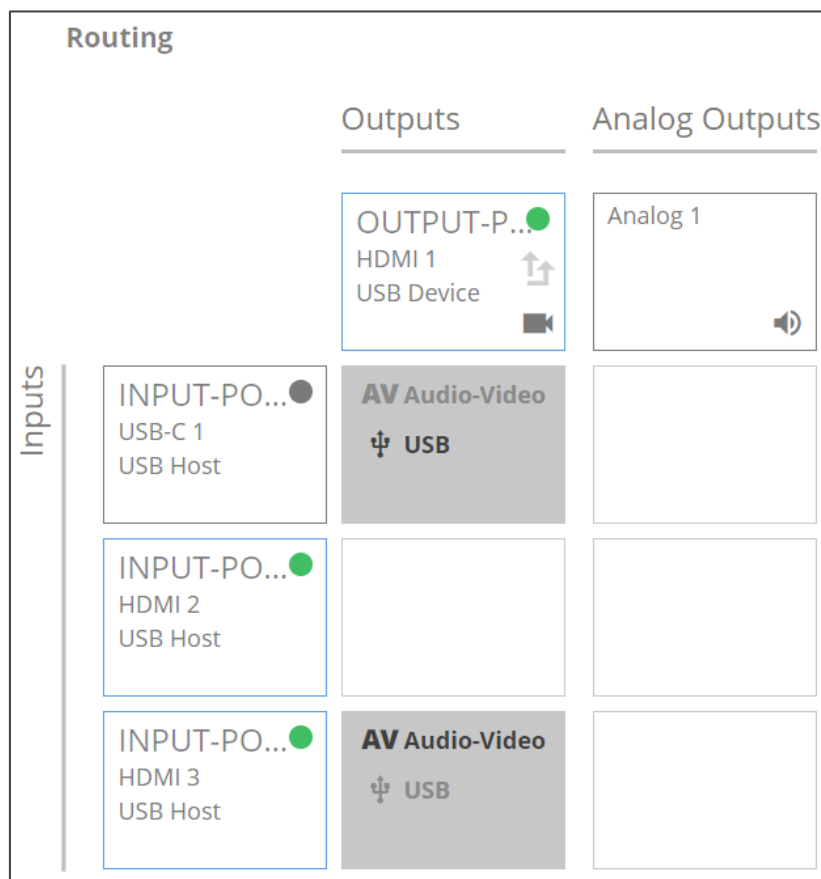



Figure 16: Individual routing of USB Host and AV Signal

Setting Analog Audio Output Level

To set the audio output level:

1. Go to the Routing Settings page.
2. Under Analog Outputs click .
3. Set the audio level using the slider next to Analog output volume (dB, from -100 to 15).

Audio level is set.

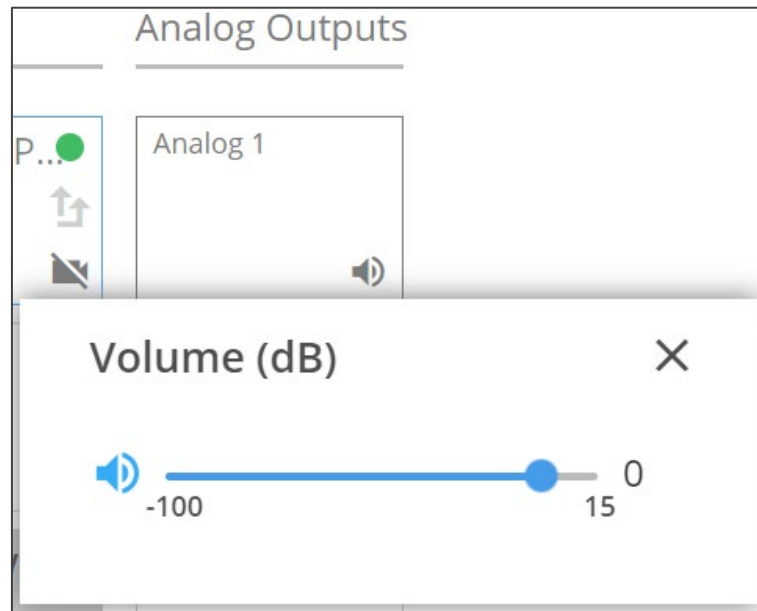

Figure 17: Setting Audio Output Level

Video inputs are routed to the outputs.

Setting AV Properties

This section details the following actions:

- [Setting the Auto-Switching Policy](#) on page [23](#).
- [Configuring AV Settings](#) on page [25](#).
- [Managing EDID](#) on page [26](#).

Setting the Auto-Switching Policy

To set the auto-switching policy:

1. Go to the Auto switching page.
2. Next to the Selection Mode drop-down box, select the auto switching policy: **Manual**, **Last Connected** or **Priority**.

Switching policy is set.

To change input priorities:

1. Go to the Auto switching page.
2. Next to the Selection Mode drop-down box, select **Priority**.
3. Click and drag an input between high and low to change the priorities.

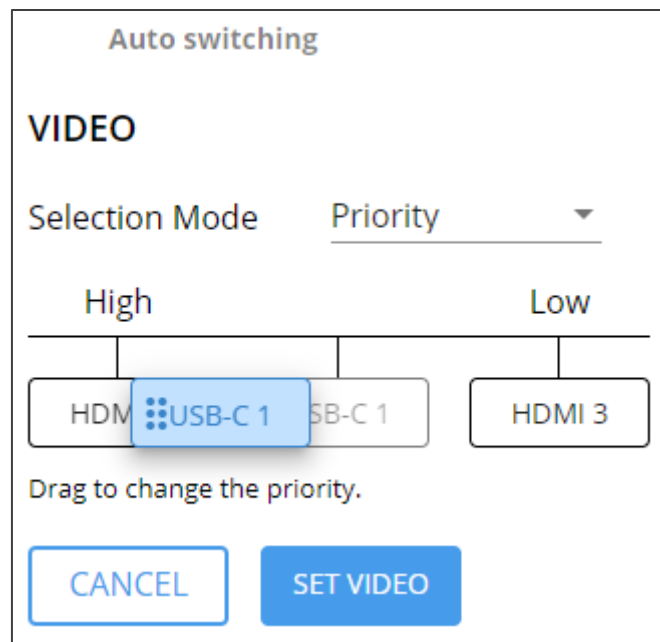

Figure 18: Changing Input Priorities

4. Click **SET VIDEO**.
Input priorities are set.

Configuring AV Settings

SWT3-31-HU enables configuring the device audio and video settings.

To configure audio and video settings:

1. Go to the Audio Video Settings page. The Audio Video Settings page appears.

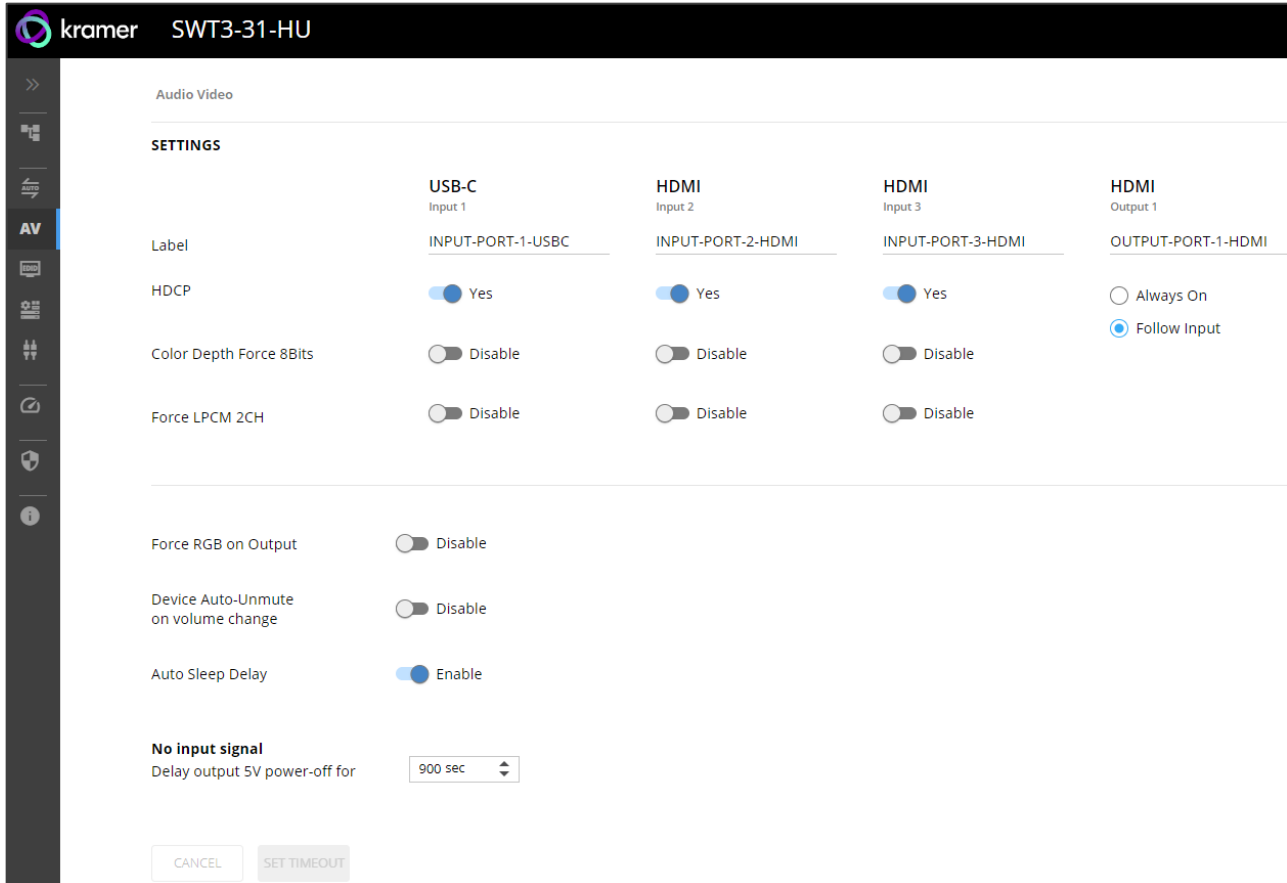

Figure 19: Audio Video Settings

2. Perform the following actions:

- Label – Change the name of an input or the output as it appears on the Routing page and EDID management page.
- HDCP – For the inputs, select the **Yes** (default) /**No** switch to enable/disable HDCP for that input. For the output, select **Always On** keep HDCP enabled or **Follow Input** (default) to define the output HDCP setting according to the active input.
- Color Depth Force 8Bits – **Enable** or **Disable** (default) on each input.
- Force LPCM 2CH – **Enable** or **Disable** (default) on each input.
- Force RGB on Output – **Enable** or **Disable** (default).
- Device Auto-Unmute on volume change – When enabled changing the volume will auto-unmute the audio output.
- Auto Sleep Delay – When no input signal is detected, the display automatically goes into sleep mode, and output is set to off. When this setting is enabled (default), it delays sleep mode for an amount of time specified in the next setting.

- No input signal (active when Auto Sleep Delay is enabled) – Set the number of seconds (30 to 60,000 seconds; default = 900 seconds) after there is no signal detected, until the display goes into sleep mode. Click **SET TIMEOUT** after defining this setting.

Audio and video settings are configured.

Managing EDID

SWT3-31-HU enables you to copy an EDID from one of several different sources to the inputs.

To copy the EDID to the inputs:

1. Go to the EDID Management page.

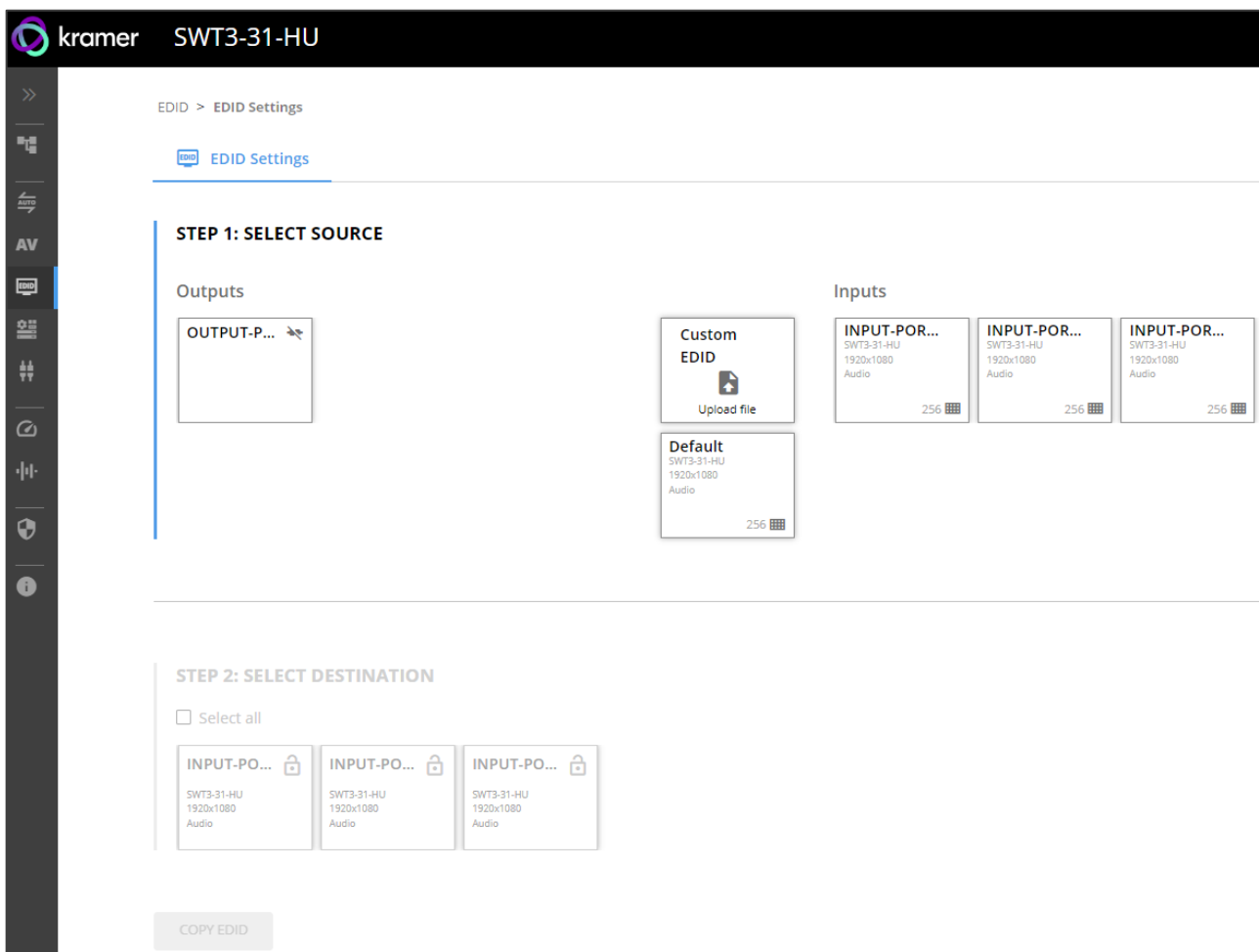

Figure 20: EDID Management Page

2. Under Step 1, select the EDID source (the output, any of the inputs, default or custom EDID).
3. Under Step 2, select one or more inputs as the destination for copying the EDID.
4. Click **COPY EDID**.

The EDID is copied.

Setting Device Properties

This section details the following actions:

- [Device Profile and Maintenance](#) on page [27](#).
- [Settings Networking Properties](#) on page [30](#).
- [Setting Time and Date](#) on page [33](#).

Device Profile and Maintenance

Changing Device Name

SWT3-31-HU enables you to change the DNS name of the device.

To change the device name:

1. Go to the Device > General page.

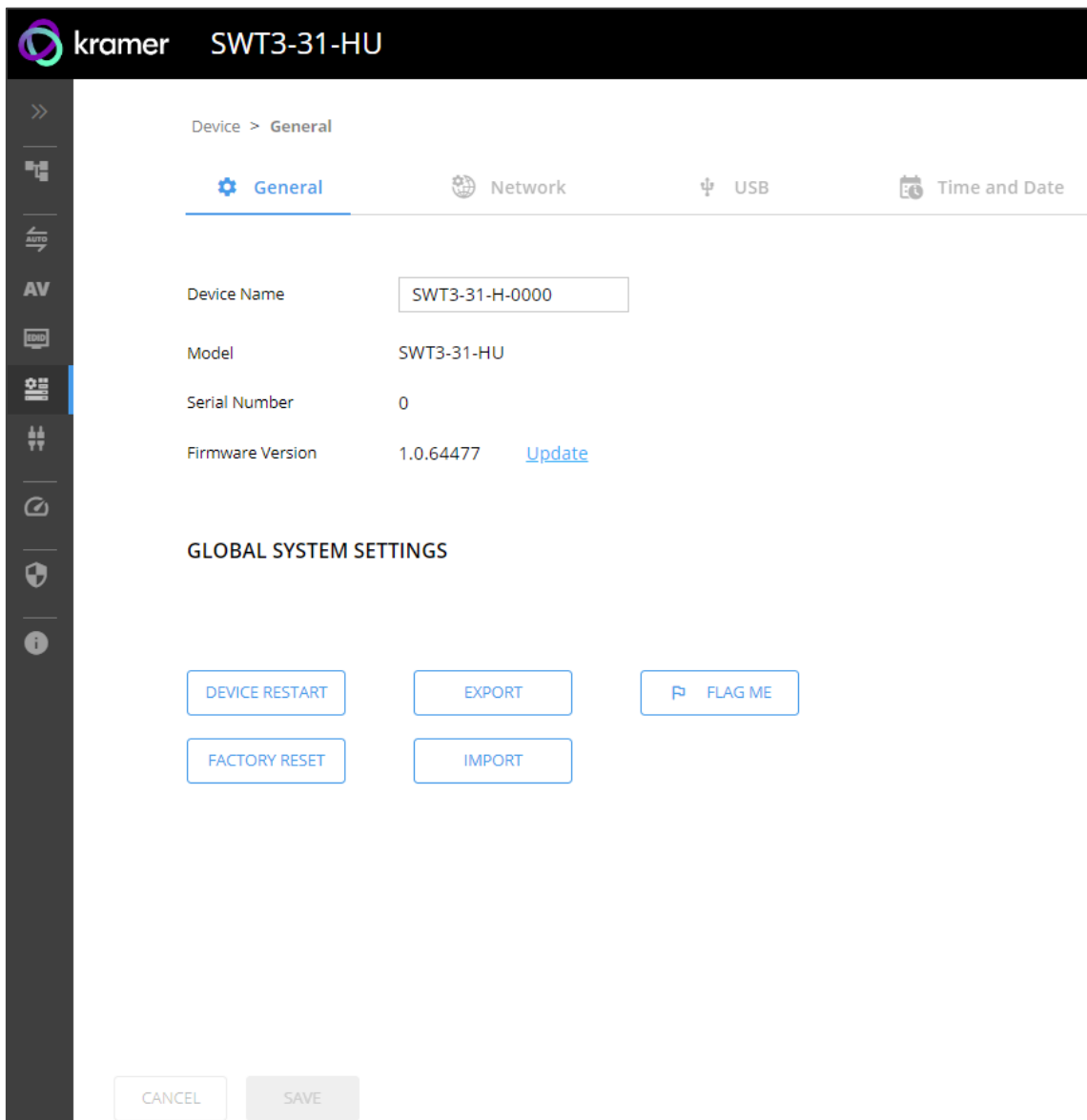

Figure 21: Device > General Page

2. Under General Preferences, change the device name and click **SAVE**.

The device name is changed.

Upgrading Firmware

To upgrade the device firmware:

1. Go to the **Device > General** page ([Figure 21](#)).
2. Under General, click **Update**, open the relevant firmware file, and follow the instructions. The upgrade takes approximately 30-60 seconds.



- During FW upgrade, the device continues to operate, but the device UI and protocol 3000 communication are inactive. When device restarts, the status LED is lit, and HDMI output signal is disconnected until restart completes.

Firmware is updated.

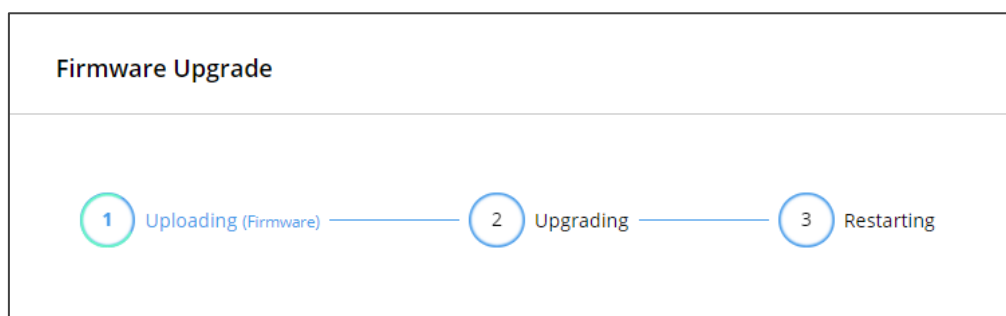

Figure 22:Firmware Upgrade Process

Resetting and Restarting Device

Two types of resets can be performed:

- **Restart** – Reboots your device and keeps all your device settings, including the IP address and password.
- **Reset** – Reboots your device and restores all factory settings including input/output definitions, switching configuration, IP address and password (a DHCP-acquired IP address is retained).

To restart the device:

- Click **DEVICE RESTART** on the **Device > General** page ([Figure 21](#)).

To perform a factory reset on the device, use one of the following actions:

- Click **FACTORY RESET** on the **Device > General** page ([Figure 21](#)).
- Using protocol 3000 commands, send **FACTORY** command then **RESET** commands.
- On the rear panel, press and hold the **RESET** button while connecting the power for several seconds.

Exporting and Importing a Configuration File

SWT3-31-HU enables you to export and store (in connected browsing PC storage) a configuration file, that records all current device settings except the routing operation setup. The stored file can then be imported to the same or different **SWT3-31-HU** device to load the recorded settings, for configuration backup and/or solution-replication purposes.

Exporting a Configuration File

To export a configuration file of the current device settings:

1. Go to the **Device > General** page ([Figure 21](#)).
2. Under Global System Settings, click **EXPORT**.
3. Select the storage location on your computer to save the configuration file and click **SAVE**.

The configuration file is exported and saved.

Importing a Configuration File

To import a configuration file of the current device settings:

1. Go to the **Device > General** page ([Figure 21](#)).
2. Under Global System Settings, click **IMPORT**.
3. Select the relevant configuration file from your computer storage and click **SAVE**.

The configuration file is imported and the device restarts with the settings from the configuration file.

Identifying Your Device

To identify the device:

1. Go to the **Device > General** page ([Figure 21](#)).
2. Under Global System Settings, click **FLAG ME**. NET LED flashes.



FLAG ME indication turns off after 60 seconds.

The device is identified by the discovery system.

Settings Networking Properties



By default, DHCP is set to on. The IP address shows the actual IP address acquired from the DHCP server, or the auto-acquired fallback IP address when there is no DHCP server detection.

To configure network settings:

1. Go to the **Device > General** page ([Figure 21](#)).
2. Select the **Network** tab.

The network page appears.

Setting	DHCP On	DHCP Off
DHCP	On	Off
MAC Address	00-1d-56-09-20-49	00-1d-56-09-20-49
IP Address	192,168,1,39	192,168,1,39
Mask Address	255,255,255,0	255,255,0,0
Gateway Address	192,168,0,1	192,168,0,1

Figure 23: Device Settings > Network Page (DHCP On/DHCP Off)

3. Change settings as needed.
If required, Set to **DHCP** (default) or static IP address resolution modes.
4. When in Static IP mode, perform the following actions:
 - Change the IP address.
 - Change the Mask address.
 - Change the Gateway address.

Network settings are defined.

Setting USB-C/B Host Port Signals Mix

AV and USB combined signals mix, and their data rate levels, of the USB-C/B host port, can be flexibly set.



To apply the USB-C type change, device power cycle must be performed.



USB-C/B ethernet connection is disabled by default and is enabled only by API command (see [Protocol 3000 Commands](#) on page 54).

To select USB-C/B host port signals mix:

1. Go to the **Device** > **General** page ([Figure 21](#)).
2. Select the USB tab.

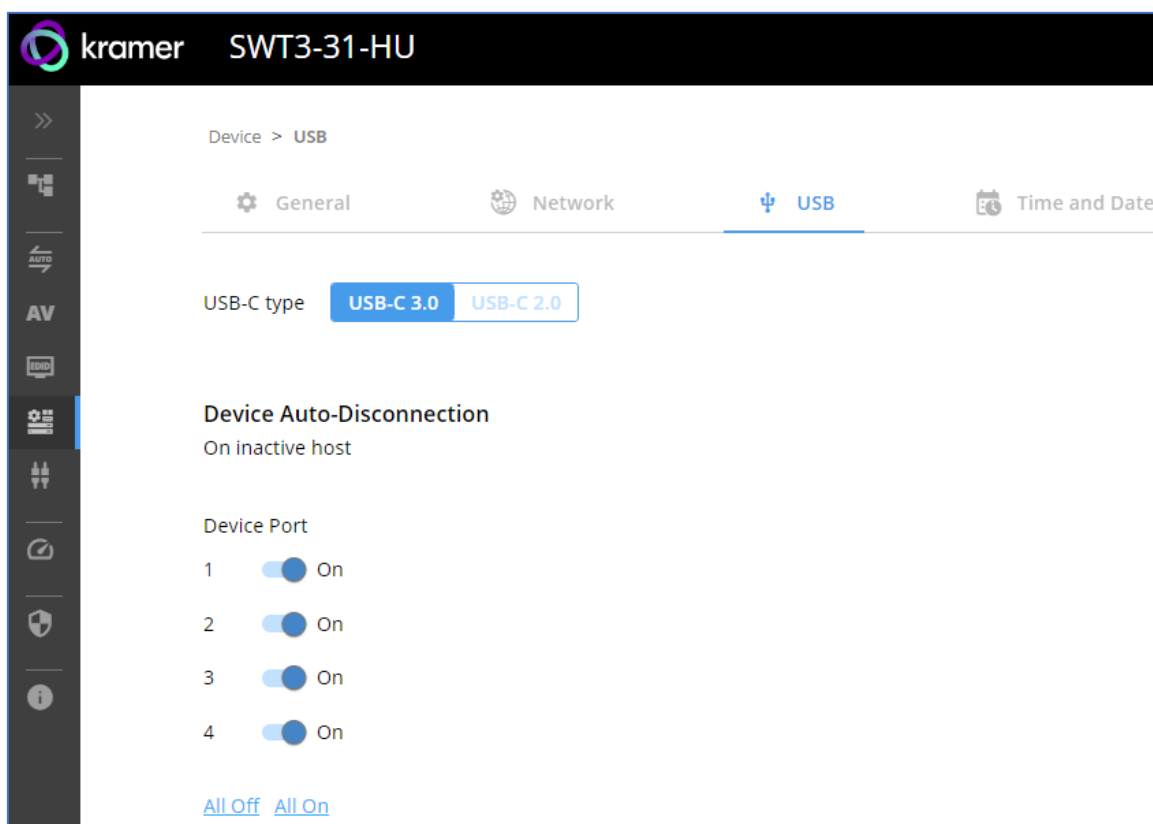

Figure 24: USB Page – USB-C Host Port Data Range Level Selection

3. Next to USB-C/B type, select one of the following:
 - **USB-C/B 3.0** - High USB 10Gbps data rate and lower 4K60 4:2:0 AV resolution mix.
 - **USB-C/B 2.0** - High 4K60 4:4:4 AV resolution and lower USB 480Mbps data rate mix.
4. Click **SAVE**.

USB-C/B host signals mix is set.

Auto-disconnecting a USB Device on Inactive Host

When a host becomes inactive, you can automatically disconnect one or multiple USB devices.

To define auto-disconnection:

1. Go to the **Device > General** page ([Figure 21](#)).
2. Select the USB tab.

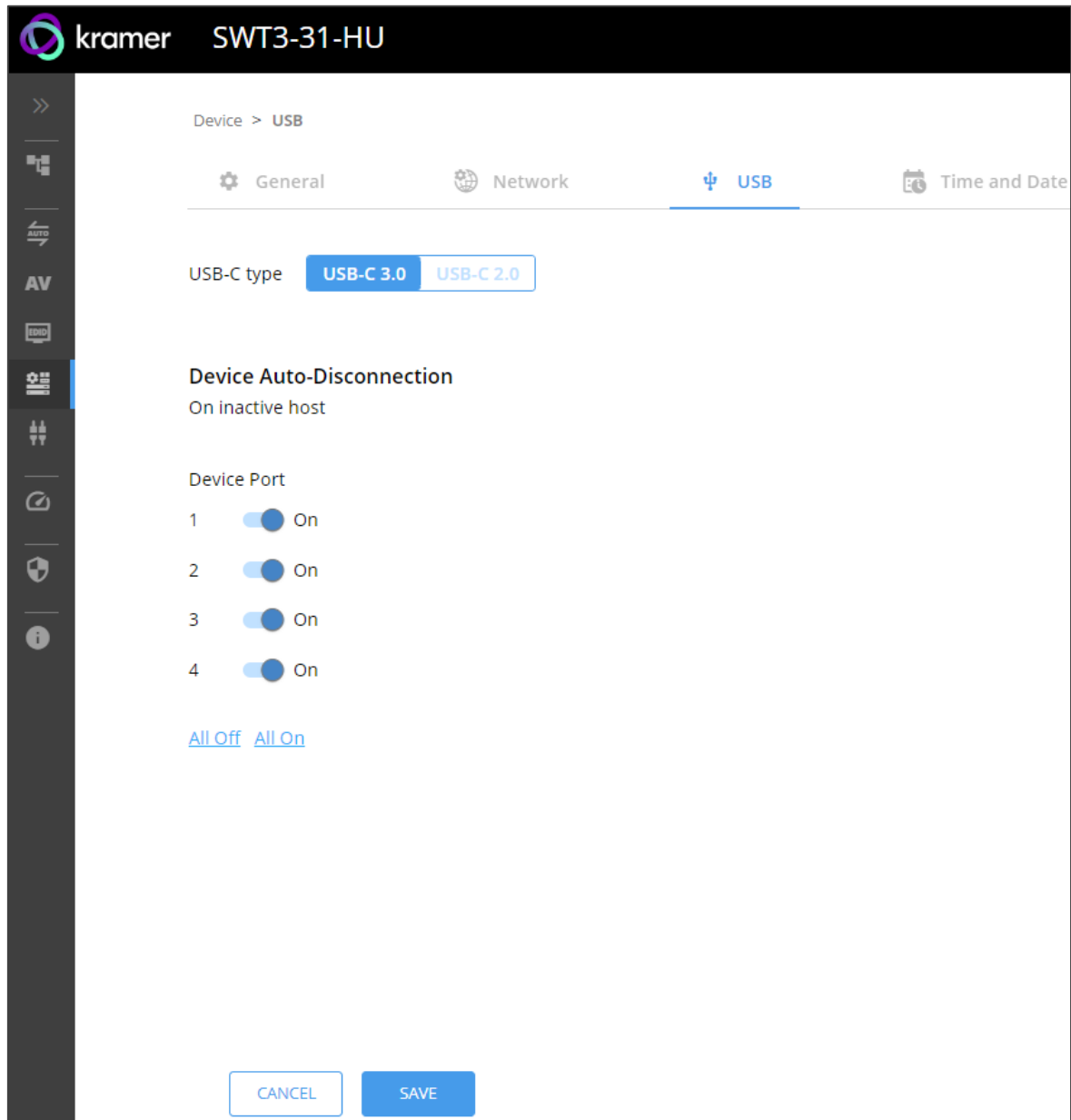

Figure 25: USB Page – USB Device Auto-Disconnection

3. For each USB Device Port, set the auto disconnection status to **On** or **Off**. You can also Select **All Off** or **All On** to set all device ports to off or on, respectively.
4. Click **SAVE**.

USB devices are set.

Setting Time and Date

You can sync the device time and date to any server around the world.

To sync device time and date to a server:

1. In the Navigation pane, click **Device**. The General tab in the Device page appears.
2. Select the **Time and Date** tab. The Time and Date tab appears.

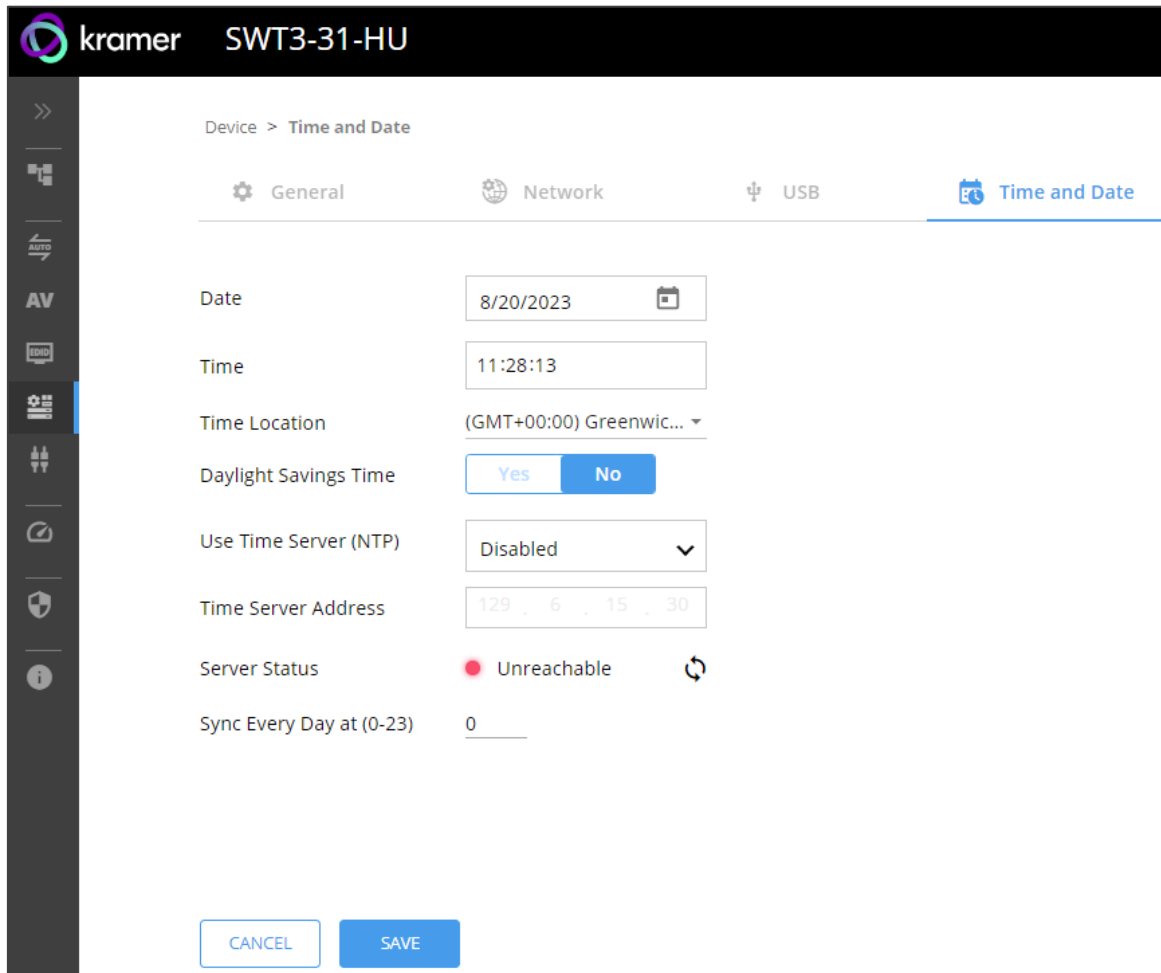

Figure 26: Device Settings – Time and Date Tab

3. Set the Date and Time.
4. Select the Time Location.
5. In the Use Time Server (NTP) drop-down box, click:
 - **Disabled** to disable the time server.
 - **Manual** to enable time server (NTP).
6. If enabled, type in server information:
 - Enter the time server address.
 - Set sync frequency (every 0 to 23 days).
7. Click **SAVE** for any change.

The devices date and time are synchronized to the server address entered.

Setting Control Gateway Properties

This section details the following actions:

- [Setting Serial Port Properties](#) on page [34](#).
- [Configuring I/O \(GPIO\) Ports](#) on page [37](#).
- [Defining and Testing Commands via Action Editor](#) on page [41](#).
- [Configuring Remote Buttons](#) on page [42](#).
- [Associating CEC Commands to DISPLAY ON/OFF](#) on page [43](#).

Setting Serial Port Properties

SWT3-31-HU enables configuring the RS-232 port in one of the following ways:

- [Controlling the SWT3-31-HU](#) on page [34](#).
- [Controlling an External Device](#) on page [35](#).
- [Controlling SWT3-31-HU Connected Display](#) on page [36](#).

Controlling the SWT3-31-HU

To set the RS-232 port to control the device:

1. Go to the Control Gateway page. The Serial Ports tab appears.

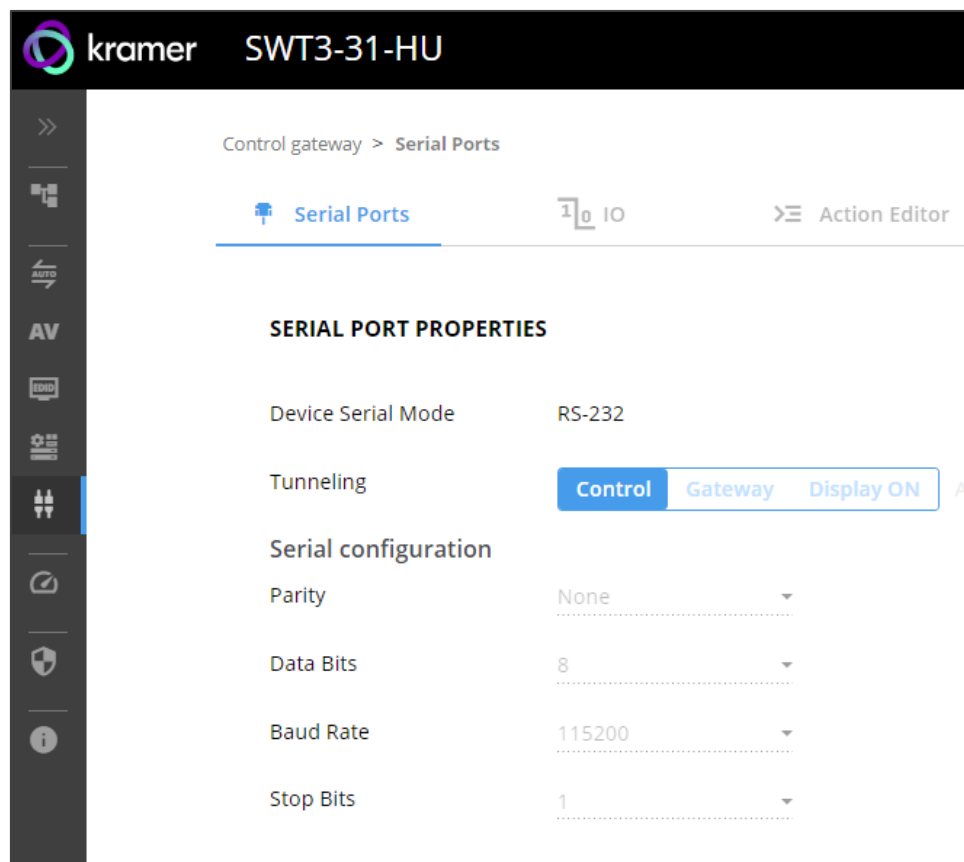

Figure 27: RS-232 Device Control

2. Next to Tunneling, select **Control**.
3. Click **SAVE**.

RS-232 port controls the **SWT3-31-HU**.

Controlling an External Device

Control an external device via an IP-connected Controller (for example **SL-240C** that is connected via LAN)

To set the RS-232 port to control an external device:

1. Go to the Control Gateway page. The Serial Ports tab appears.
2. Next to Tunneling, select **Gateway**.

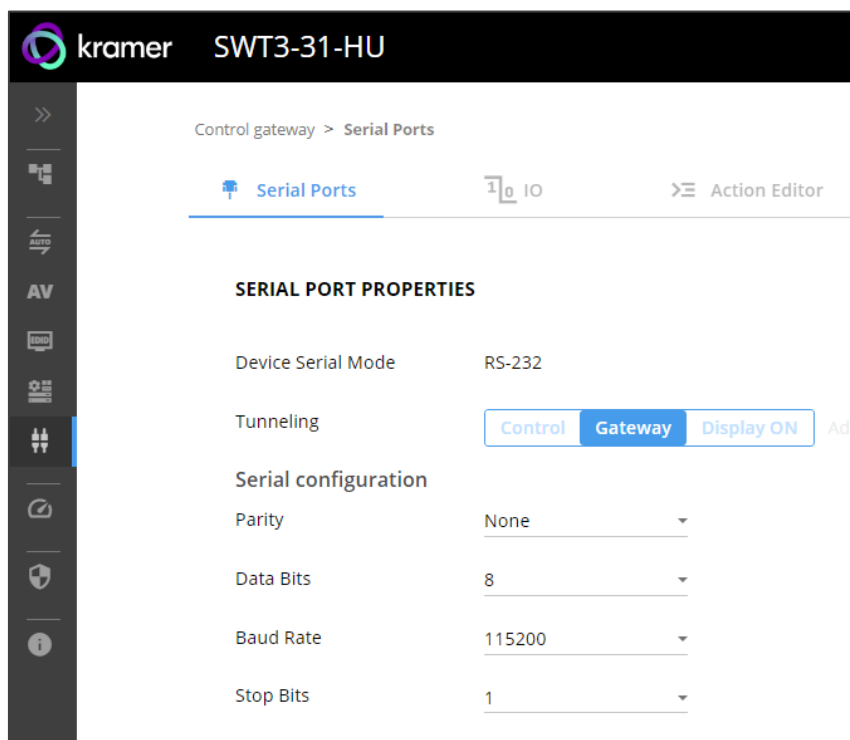

Figure 28: RS-232 as Gateway

3. Define the external device RS-232 settings (Parity, Data Bits, Baud Rate and Stop Bits).
4. Click **Save**.

The TUNNELING ADVANCED PROPERTIES screen appears.



Figure 29: Setting Tunneling Advanced Properties

5. Select either TCP or UDP port.
6. Click up/down arrows to select IP Port for sending commands to RS-232.
7. Click up/down arrows to select desired seconds for TCP Keep alive.
8. Press to toggle ON Send replies to new clients by default Bits.
9. Click **CLOSE**.
10. Click **SAVE**.

RS-232 port controls an external device.

Controlling SWT3-31-HU Connected Display

Control an external device (for example a display), connected to **SWT3-31-HU**.

The **SWT3-31-HU** sends serial, CEC or IT commands, defined by the user in the Action Editor (see [Defining and Testing Commands via Action Editor](#) on page 41) and then linked to the DISPLAY ON button (see [Associating CEC Commands to DISPLAY ON/OFF](#) on page 43).

To set the RS-232 port to control an external device:

1. Go to the Control Gateway page. The Serial Ports tab appears.
2. Next to Tunneling, select **Display ON**.

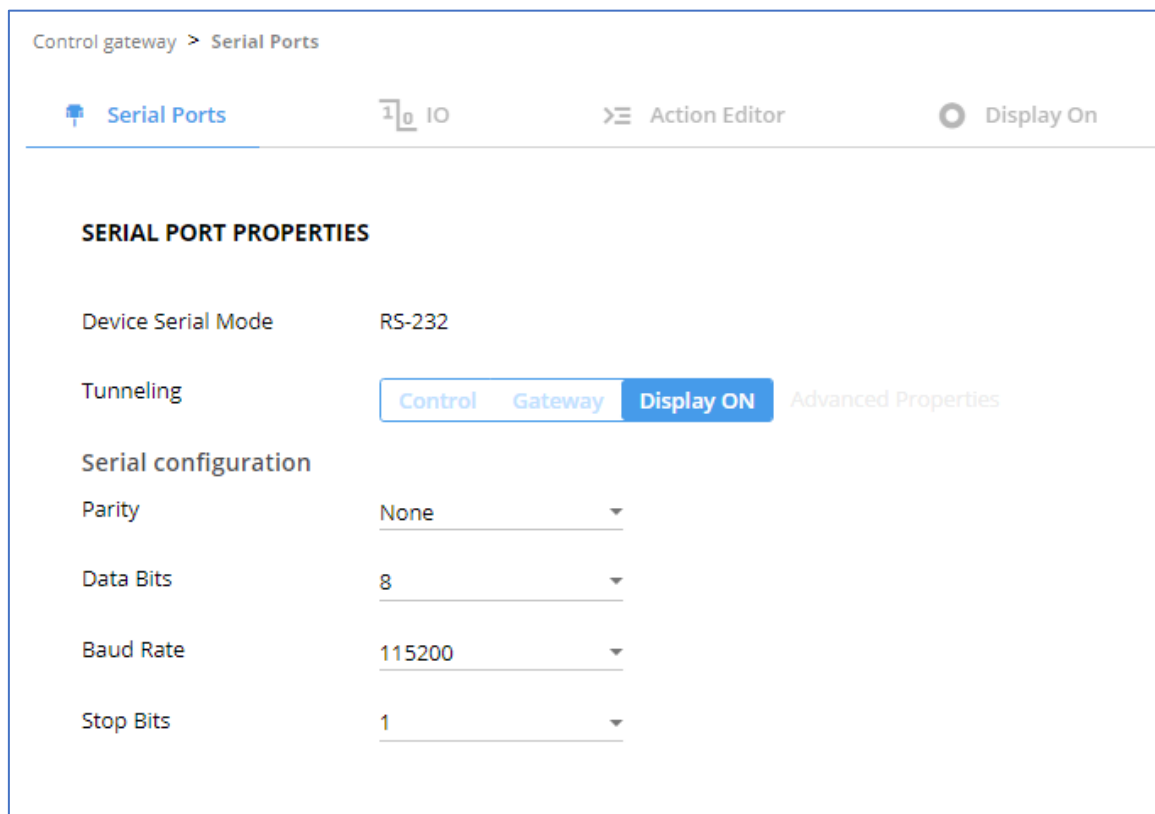



Figure 30: RS-232 Control for Display on/off

3. Define the display RS-232 settings (Parity, Data Bits, Baud Rate and Stop Bits).
4. Click **SAVE**.

RS-232 port controls the DISPLAY ON/OFF.

Configuring I/O (GPIO) Ports

The 2 I/O ports can control devices such as sensors, door locks, remote contact-closure buttons, audio volume and lighting control devices and can be configured via the webpages.

 To enable I/O operations, Remote Button must be set to Off.

To configure an I/O port:

1. In the Navigation pane, click **Control Gateway**. The Serial Ports tab in the Device Settings page appears.
2. Select the IO tab. The IO tab appears.

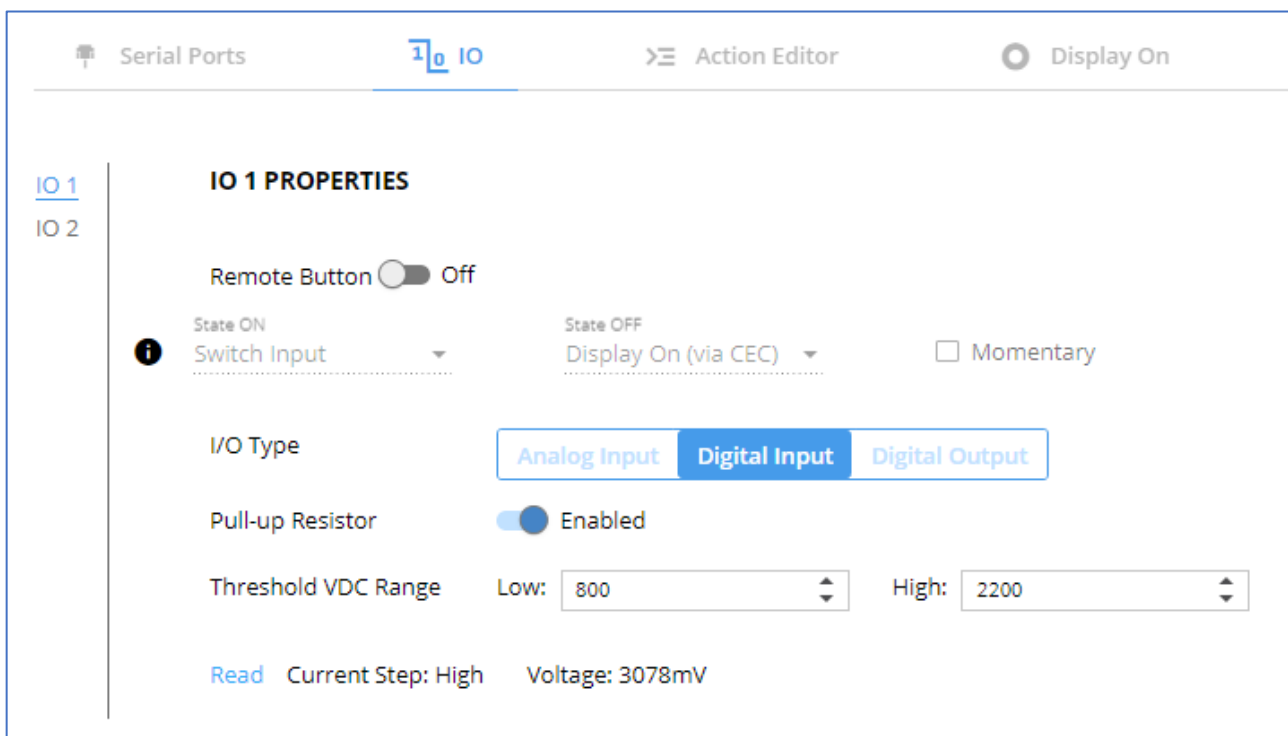

The screenshot shows the 'IO 1 PROPERTIES' configuration page. At the top, there are tabs for 'Serial Ports', 'IO', 'Action Editor', and 'Display On'. The 'IO' tab is active. On the left, there are links for 'IO 1' and 'IO 2'. The main content area is titled 'IO 1 PROPERTIES'. It includes a 'Remote Button' toggle set to 'Off'. Below this, there are two sections: 'State ON' with a dropdown menu set to 'Switch Input' and an information icon, and 'State OFF' with a dropdown menu set to 'Display On (via CEC)'. A 'Momentary' checkbox is present and unchecked. The 'I/O Type' section has three buttons: 'Analog Input', 'Digital Input' (which is highlighted), and 'Digital Output'. The 'Pull-up Resistor' is a toggle set to 'Enabled'. The 'Threshold VDC Range' section has two input fields: 'Low: 800' and 'High: 2200'. At the bottom, there is a 'Read' button and a status display showing 'Current Step: High' and 'Voltage: 3078mV'.

Figure 31: I/O Ports Settings Page

3. Select the I/O port to be configured (IO 1 or IO 2).
4. Select one of the following I/O types:
 - **Digital Input (default setting)** (see [Configuring a Digital Input I/O Type](#) on page 38).
 - **Digital Output** (see [Configuring a Digital Output I/O Type](#) on page 38).
 - **Analog Input** (see [Configuring an Analog Input I/O Type](#) on page 40).

 The settings available on the page change depending on which trigger type is selected.

5. Click **SAVE** after setting the selected I/O type.

Configuring a Digital Input I/O Type

The Digital Input trigger mode reads the digital input of an external sensor device that is connected to the I/O port. It detects High (upon passing Max threshold from Low state) or Low (upon passing Min threshold from High state) port states according to the user defined voltage threshold levels.

To configure a digital input I/O type:

1. On the GPIO page, select **Digital Input** next to I/O Type.
The Digital Input options appear ([Figure 31](#)).
2. Select one of the following for the Pull-up resistor setting:
 - **Disabled**
Suitable, for example, for a high temperature alarm that exceeds the maximum voltage threshold. When the pull-up resistor is disabled, the port state is low and to be triggered it must be pulled high by the externally connected sensor.
 - **Enabled** – Detection of an open circuit as High, or a short to ground as Low.
This is suitable for example, for a pushbutton switch (connecting one terminal of the switch to ground, and the other to the input) or for an alarm closing a circuit that activates a series of actions. When the pull-up resistor is enabled, the port state is high, and to be triggered it must be pulled low by the externally connected sensor.
3. Set the Threshold VDC Low and High Range (threshold voltage at which the port changes state).
4. Click **Read** to refresh port status information.
5. Click **SAVE**.

Digital input I/O type is configured.

Configuring a Digital Output I/O Type

To configure a digital output I/O type:

1. On the GPIO page, select Digital Output next to I/O type.
A warning message appears.

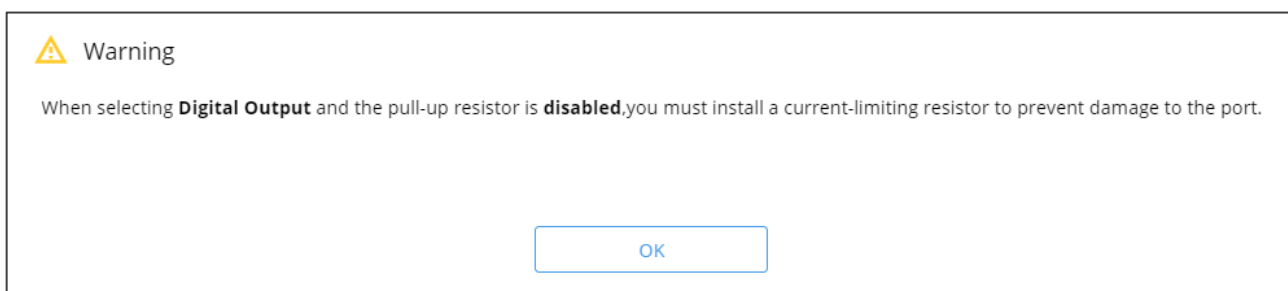

Figure 32: Digital Output Warning

2. Make sure to follow the instructions in this warning.

3. Click **OK**. The Digital Output options appear.

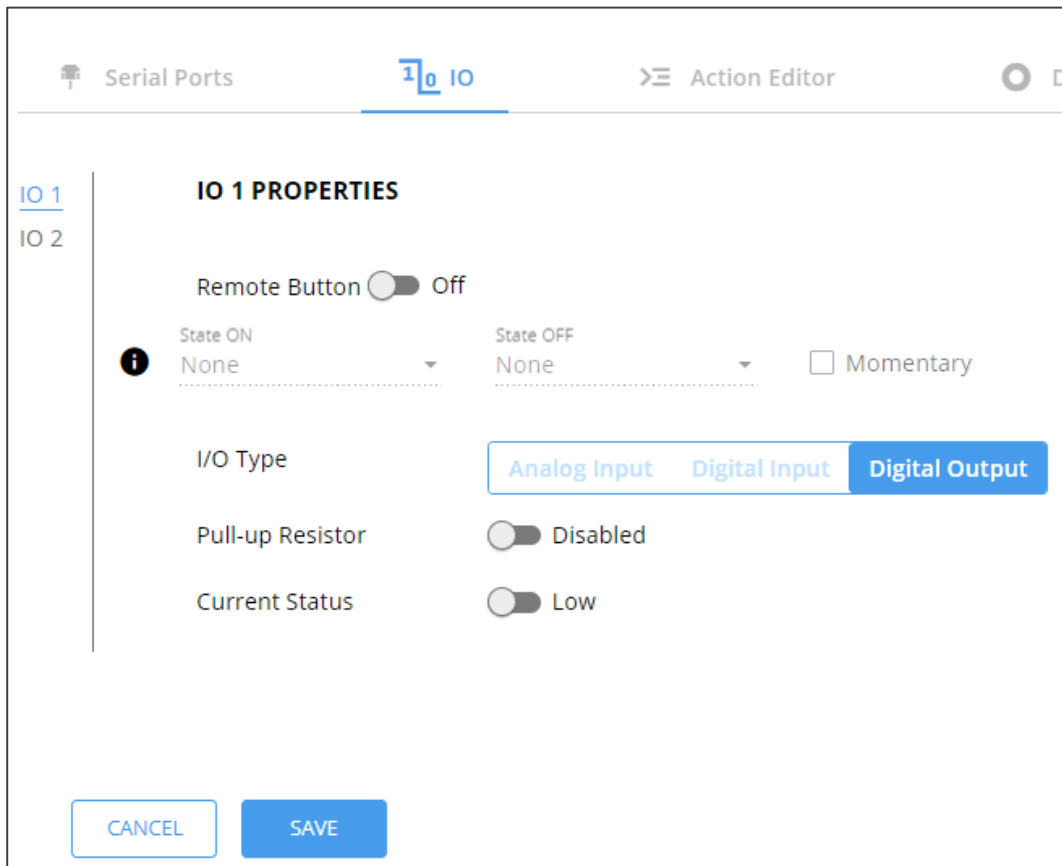



Figure 33: GPIO Settings Page – Digital Output I/O Type

4. Select one of the following for the Pull-up resistor setting:

- Pullup resistor set to **Enabled**:
The port can be used for controlling devices that accept a TTL signal such as for powering LEDs. The voltage output is TTL positive logic: high: >2.4V; low: < 0.5V. When the pull-up resistor is enabled, the port state is high. For the state to be low, you must select **Low** for the Current Status.
- Pullup resistor **Disabled**:
The port is used for controlling external devices such as room or light switches. The external source device determines the voltage output; the maximum voltage is 30V DC and the maximum current is 100mA. When the pull-up resistor is disabled, the port state is low. For the state to be high, select **High** for the Current Status.

 Make sure that the current in this configuration does not exceed 100mA.

5. Click **SAVE**.

Digital Output I/O type is configured.

Configuring an Analog Input I/O Type

When selecting the Analog Input I/O type, the port is triggered by an external analog device, such as a volume control device. The trigger is activated once when the detected voltage is within the 0 to 30V DC voltage range.

To configure an analog input I/O type:

1. On the GPIO page, select Analog Input next to I/O type.

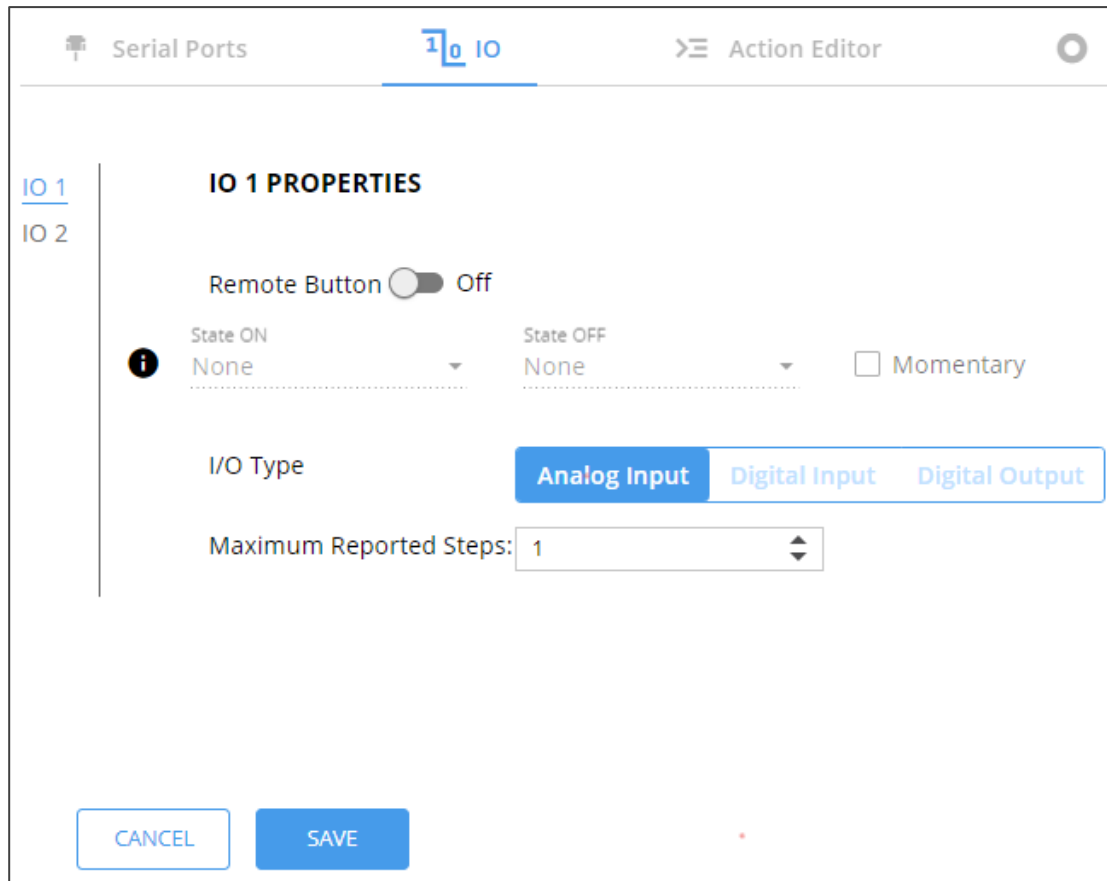

Figure 34: GPIO Port Settings Page Analog Input

2. Enter or use the arrows to scroll to a value (1–100) for the Maximum reported steps. This value is the number of steps that the analog input signal is divided into. To calculate the voltage of each step, use the following formula:
Voltage of one step = $30V / \text{number of steps}$.
3. Click **SAVE**.

Analog input I/O type is configured.

Defining and Testing Commands via Action Editor

Use action editor to create and test control commands via CEC, UART or IR control interfaces. You can create up to 5 commands.

To add an action:

1. In the navigation pane, select **Control Gateway**. The Serial Ports tab opens.
2. Select the **Action Editor** tab. The Action Editor appears.

Figure 35: Action Editor Tab

3. Select a command name on the left side of the window.
4. Change the command name, if required.
5. Select the port (CEC, UART or IR).
6. Enter the appropriate command line, such as one of the following Display On sample commands:

- For CEC - 1,1,tv-on,2,E004



The command to power on a TV can vary depending on the specific TV model and manufacturer. However, above is a common example of a standard command to power on a TV.

- For RS232 - PON

- For IR -

```
1,1,TVON,1,1,1,0000,006f,0022,0002,014d,00a6,0015,0015,0014,0015,0013,0014,00
15,0015,0014,0014,0014,0014,0015,0015,0014,003e,0016,003d,0014,003f,0014,003
e,0015,003f,0013,003f,0014,003e,0015,003f,0013,0016,0013,0015,0014,0015,0013,0
016,0013,003f,0013,003e,0015,0015,0013,003e,0015,003f,0013,003f,0013,003e,001
5,003e,0015,0015,0014,0015,0013,003f,0014,0015,0013,0014,0015,05c9,014d,0053,
0015,0e0a
```

7. Click **SAVE**.
8. Click **RUN COMMAND** to run the command test.

An action is entered and can be run.

Configuring Remote Buttons

Remotely operate, by I/O-connected remote buttons, configured control actions (see (see [Defining and Testing Commands via Action Editor](#) on page 41).

To Configure Remote Buttons:

1. In the Navigation pane, click **Control Gateway**. The Serial Ports tab in the Device Settings page appears.
2. Select the IO tab. The IO tab appears.
3. Press to toggle **Remote Button** to On.
4. Configure defined control actions, for button on/off states, using the **State ON**, **State OFF** drop-down boxes.
 - Button default operation mode is latching. For momentary mode, check the Momentary checkbox.

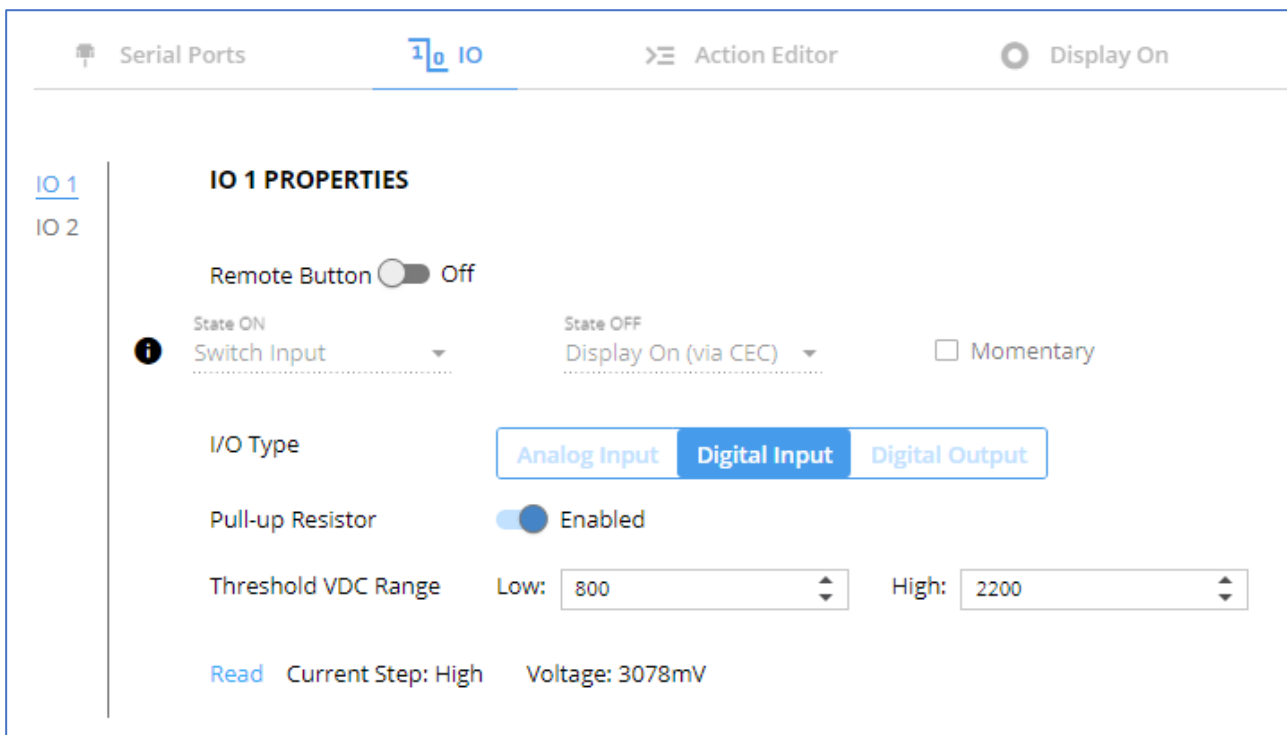

Figure 36: I/O ports settings tab – Configuring Remote Buttons

5. Click **SAVE**.

A control actions remote button can now be remotely operated.

Associating CEC Commands to DISPLAY ON/OFF

Configure CEC commands to send via DISPLAY ON button.

To add an action:

1. In the navigation pane, select **Control Gateway**. The Serial Ports tab opens.
2. Select the **Display On** tab. The Display ON settings appears.

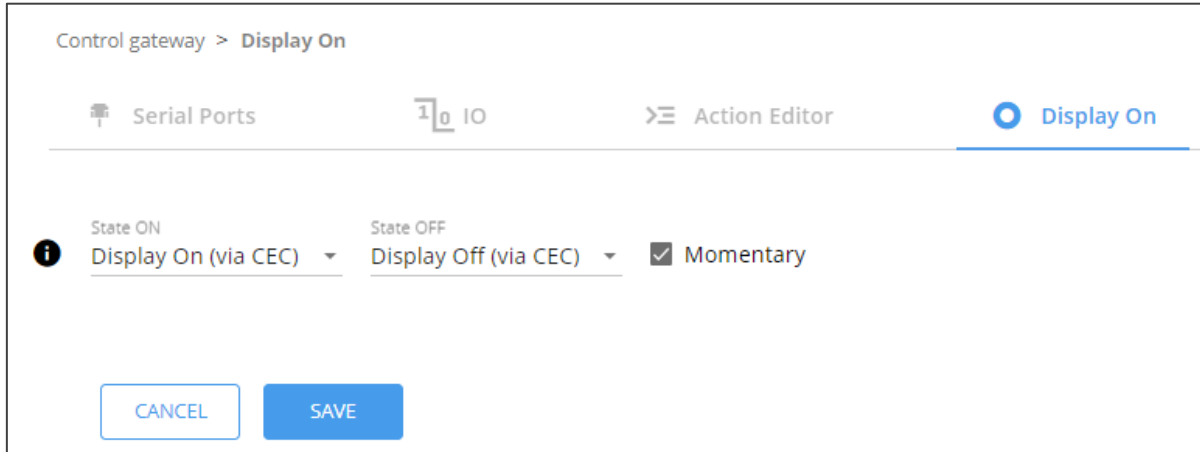

Figure 37: Action Editor Tab

3. Define the State On and State Off commands.
4. Check **Momentary** for the button to send a command on the press of a button.
5. Click **SAVE**.

DISPLAY ON button is configured.

Viewing Device Status

View the device status.

To view the device status:

1. In the navigation pane, select **Status**.
2. Select the **Devices** tab. The Devices Status appears.

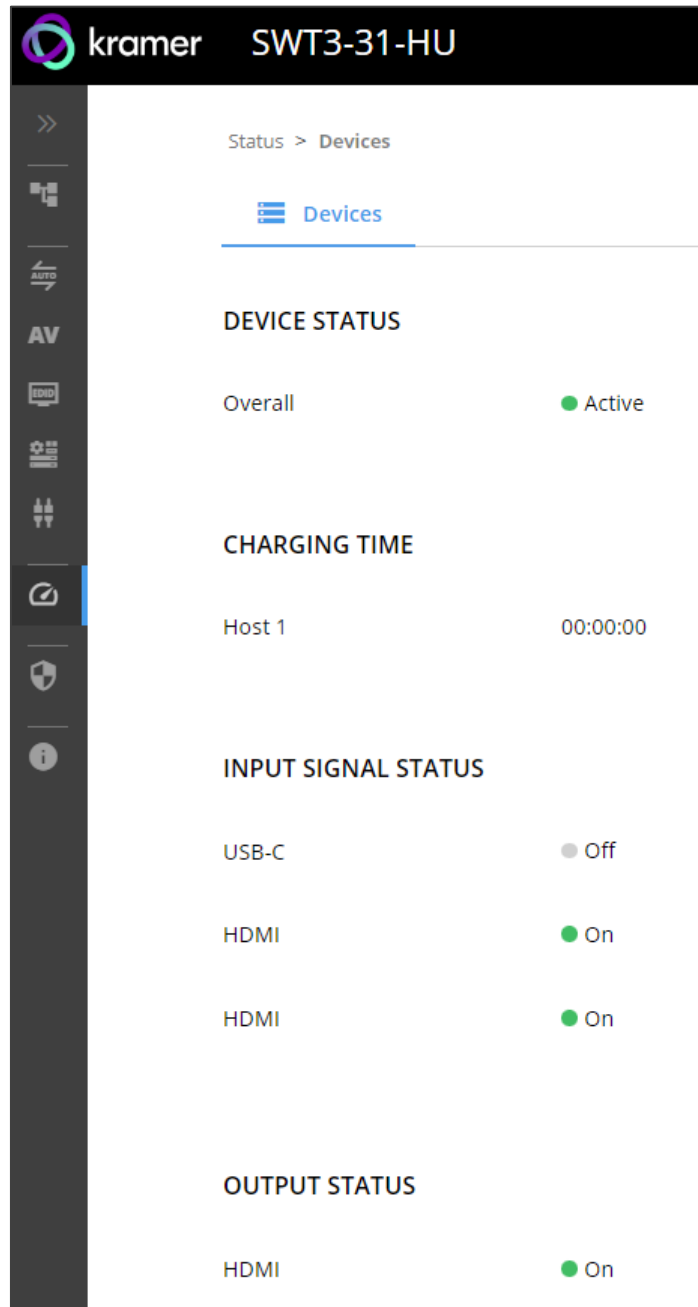

Figure 38: Device Status Page

3. View device status.

Device status can be viewed.

Setting Security Properties

This section details the following actions:

- [Changing Security Status](#) on page [45](#).
- [Defining 802.1X Authentication](#) on page [47](#).

Changing Security Status

By default, security status is set to On.

Setting Security Status to Off

To set security status to Off:

1. Go to the Security page ([Figure 39](#)).
2. Select the Security tab. The Security settings appears.

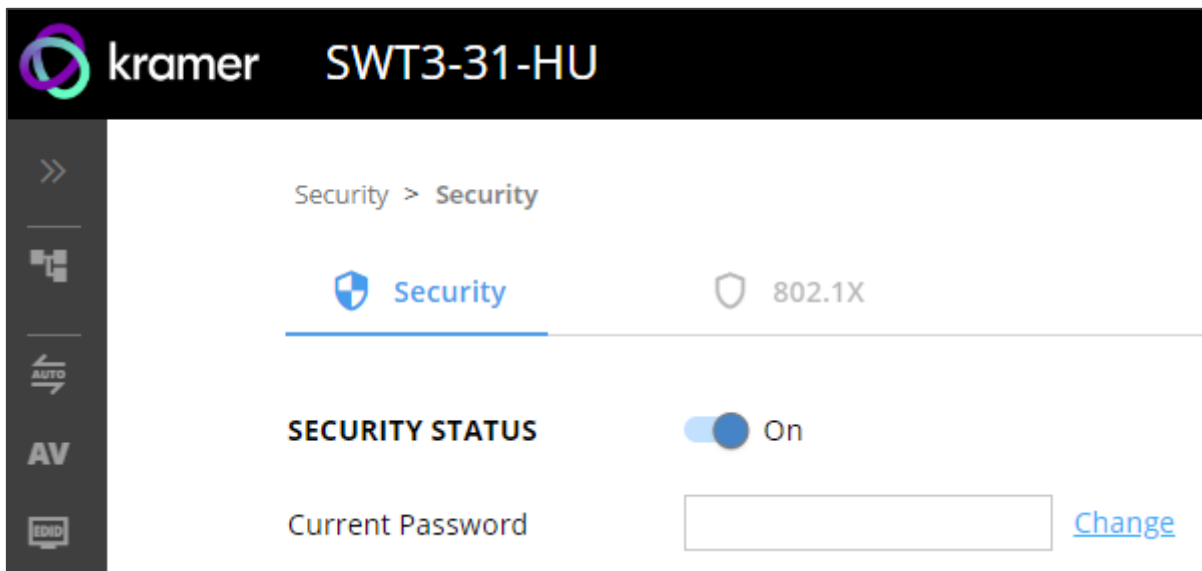

Figure 39: Security – Security Tab

3. Set **SECURITY STATUS** to **Off**. The Security Status window appears.

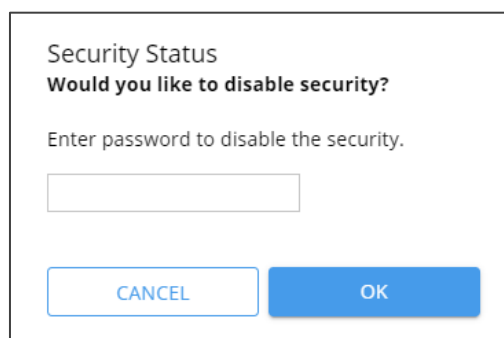

Figure 40: Security Status Message

4. Enter the current password.
5. Click **OK**.

Security status is set to Off.

Setting Security Status to On

To set security status to on:

1. Go to the Security > Security ([Figure 39](#)).
2. Set SECURITY STATUS to **On**.

Security status is set to On.

Changing Web Pages Access Password

To change the password for accessing the embedded web pages:

1. Go to the Security page ([Figure 21](#)).
2. Select the Security Tab. The Security settings appear ([Figure 41](#)).
3. Enter the Current Password and click **Change**. The new password settings appear.

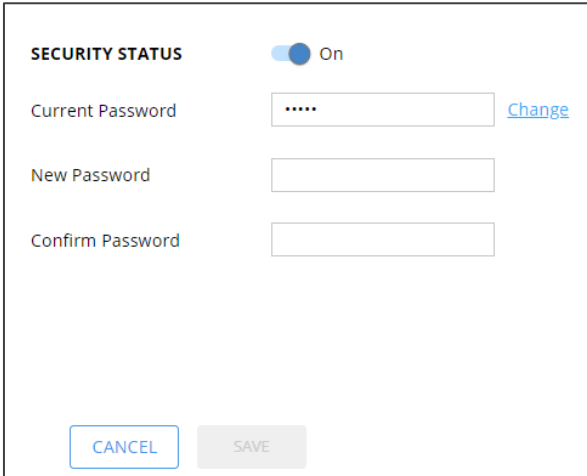

The screenshot shows a settings panel for security. At the top, 'SECURITY STATUS' is followed by a blue toggle switch labeled 'On'. Below this are three input fields: 'Current Password' (containing five dots), 'New Password', and 'Confirm Password'. To the right of the 'Current Password' field is a blue 'Change' link. At the bottom of the panel are two buttons: 'CANCEL' and 'SAVE'.

Figure 41: Device Settings – Changing the Password

4. Enter the new password and confirmation password and click **SAVE**.

The password is changed.

Defining 802.1X Authentication

802.1x security standard supports IT networking authentication based on LAN port and MAC address.

To configure security:

1. In the Navigation pane, click **Security**. The Security settings tab in the Security page appears.
2. Select **802.1X** tab. The 802.1X settings tab appears (see [Figure 42](#)).

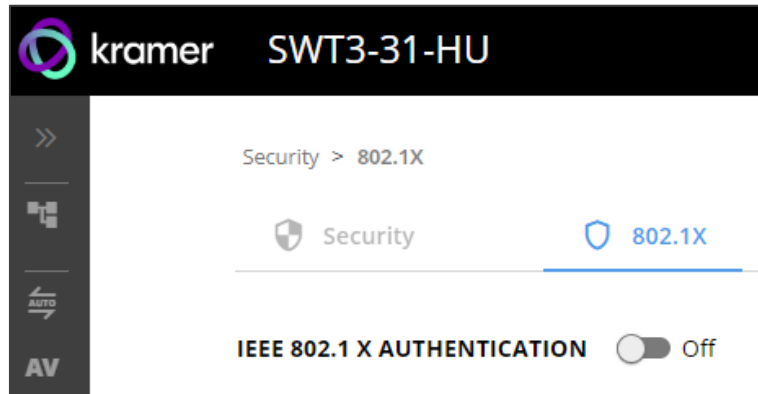

Figure 42: 802.1X Tab

3. For 802.1x authentication, click **ON** to enable 802.1x authentication service. 802.1x supports authentication based on port and MAC address.
4. When set to ON check one standard authentication method to set its security attributes.
 - **PEAP-MSCHAP V2** (Figure 43) – Enter:
 - Username - up to 24 alphanumeric characters, including “_” and “-“ characters within the username, and
 - Password - up to 24 ASCII characters

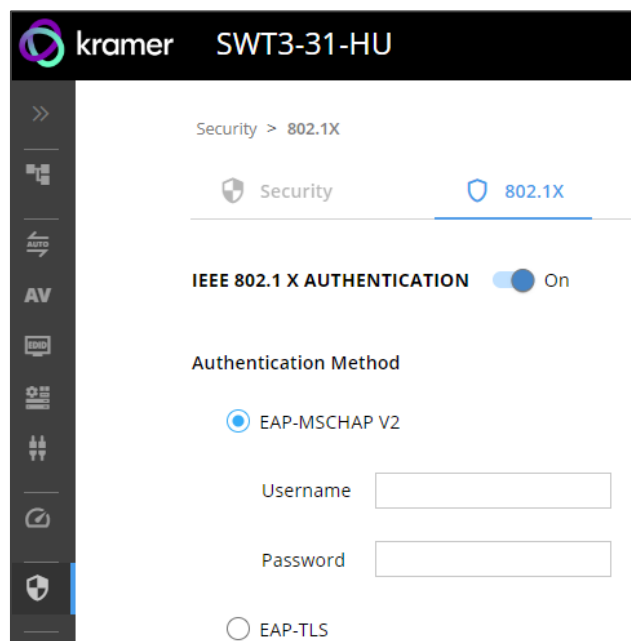

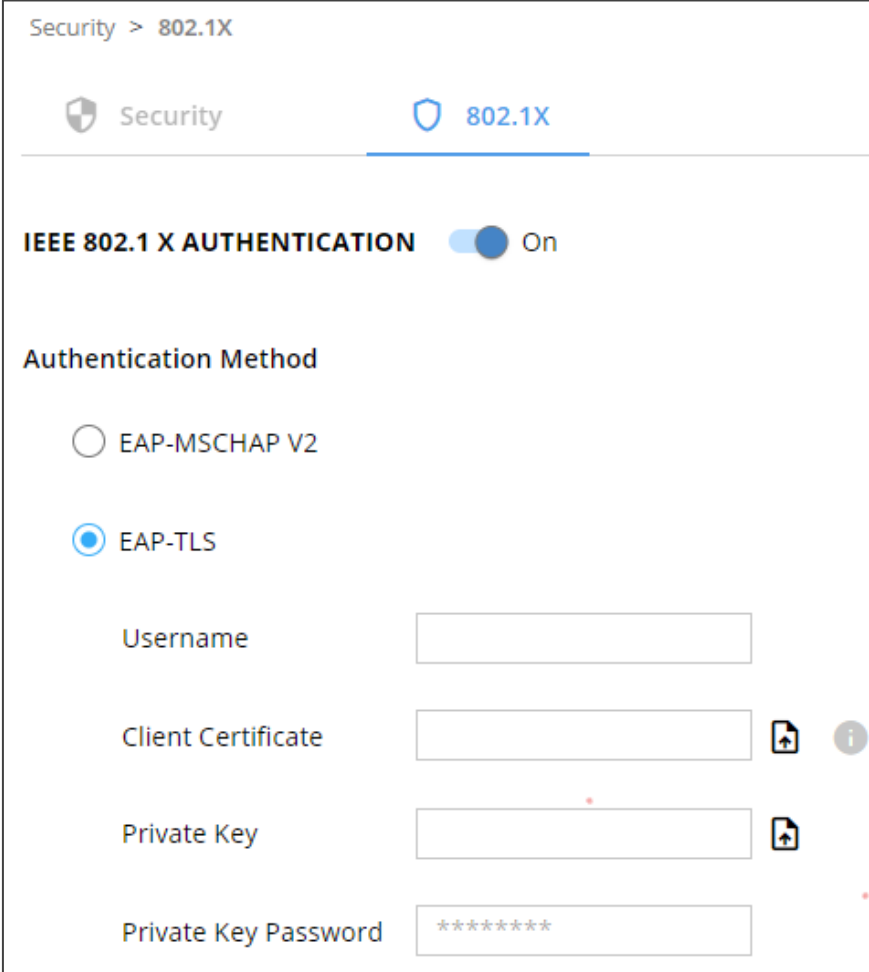

Figure 44: Security Tab – EAP-MSCHAP V2 Authentication

- **EAP-TLS** (Figure 45) – To submit certificate from the server for authentication:
 - Enter Username,
 - Click  to upload the certificates and keys.
-  File format must be pem.
- Enter the private key password (assigned by IT administrator),
 - Set Server Certificate **On**



Security > 802.1X

Security 802.1X



IEEE 802.1 X AUTHENTICATION On

Authentication Method

EAP-MSCHAP V2

EAP-TLS

Username

Client Certificate  

Private Key 

Private Key Password

Figure 46: EAP-TLS – Certificates and Password

5. Click **APPLY**.

802.1x authentication security is configured.

Viewing the About Page

View the firmware version and Kramer Electronics Ltd details in the About page.

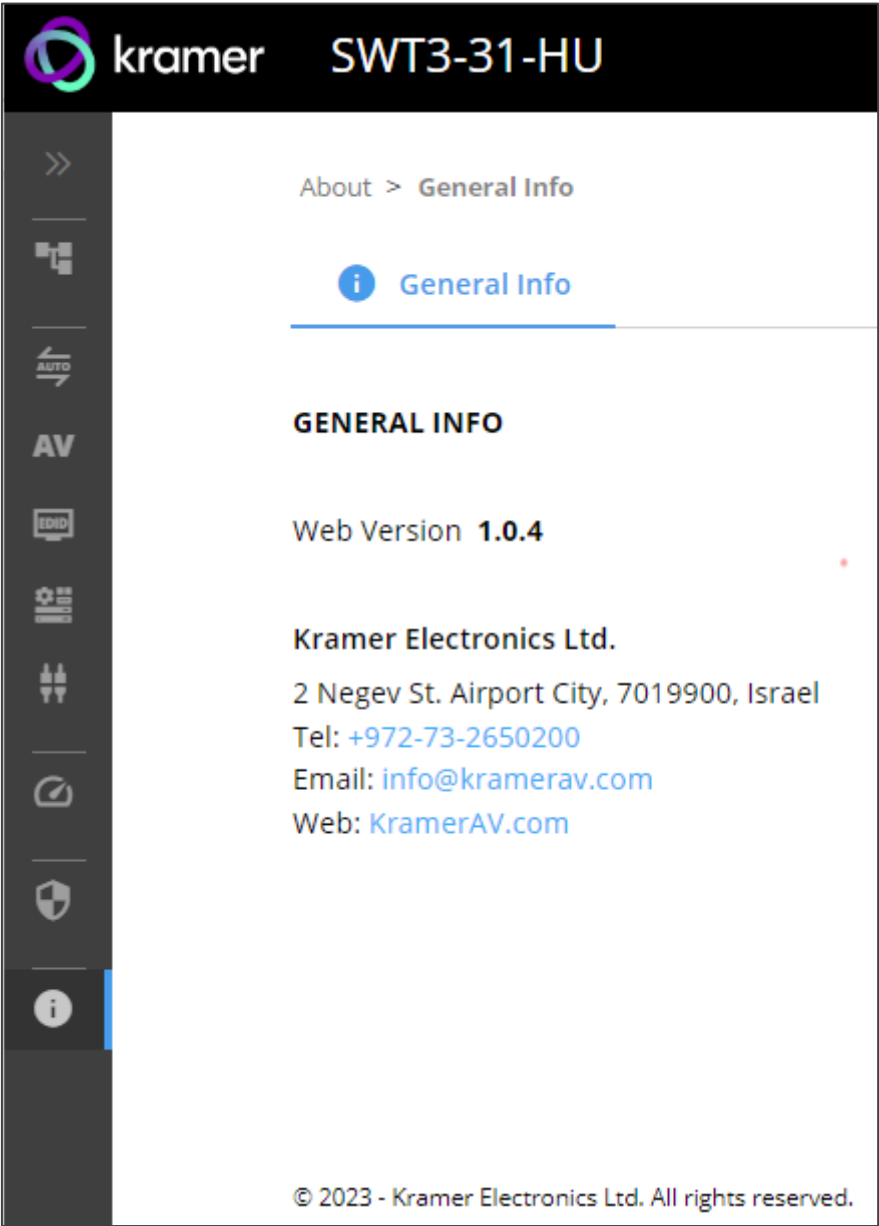

Figure 47: About Page

Upgrading Firmware



Use the Kramer **K-UPLOAD** software to upgrade the firmware via ethernet or the RS-232 port, allowing RS-232 to control/program the device). The device continues to operate and once FW upload complete, you are asked to Restart no or later.

The latest version of **K-UPLOAD** and installation instructions can be downloaded from our website at: www.kramerav.com/support/product_downloads.asp.



Note that in order to use the micro USB port, you need to install the Kramer USB driver, available at: www.kramerav.com/support/product_downloads.asp.

Technical Specifications

Inputs	2 HDMI	On HDMI female connectors
	1 DP Alt Mode & PD 3.0 USB-C	On a USB type-C female connector
Outputs	1 HDMI	On an HDMI connector
	1 HDMI Loop	On an HDMI connector
	1 Balanced Stereo Line Level	On a 5-pin terminal block connector
	1 IR	On a 3.5mm mini jack
Ports	1 USB 3.2 Host	On a USB-C female connector
	2 USB 3.2 Host	On USB-B female connectors
	4 USB 3.2 Device	On female USB-B connectors
	1 LAN PoE	On an RJ-45 female connector
	1 RS-232	On a 3-pin terminal block
	2 GPI/O	On 2-pin terminal block connectors
USB Features	USB 3.2 Data Rate	Up to 10Gbps
	Integrated USB Hubs	1
	Standards Compliance	USB 3.2 GEN 2, 2.0 and 1.1
Video	Max Data Rate	18Gbps bandwidth (6Gbps per graphic channel)
	Max Resolution	4K@60Hz (4:4:4) resolution
	Content Protection	HDCP 2.3
	HDMI Support	Deep Color, 3D, HDR as specified in HDMI 2.0b
Analog Audio Output	Impedance Balanced	500Ω
	THD + Noise: (Non-weighted)	-84dB (0.0065%)
	Crosstalk	<-85dB
	Max Output Signal Level	4.2Vrms
	Coupling	DC
	Impedance Balanced	500Ω
Power	Included Power Adapter  For HW Rev 02 and higher, 20V PSU (power supply unit) is included (replacing the 12V PSU).	Source: 20V DC, 6A
		Consumption: 4.4A
		Max. Power: 84W
	Optional Power Adapter	Source: 12V DC, 2A
		Consumption: 1.8A
		Max. Power: 22W
	LAN PoE	Consumption: 144mA
		Max. Power: 7.8W
	USB Charging	Max. Power: 60W
		 When powered with 20V power supply only
Compliance: PD 3.0		
USB Device Charging	Max. Total Current: 2A	
Controls	Front Panel	INPUT SELECT and DISPLAY ON buttons
Indication LEDs	Front Panel	1 NET LED
		1 STATUS LED
Environmental Conditions	Operating Temperature	0° to +40°C (32° to 104°F)
	Storage Temperature	-40° to +70°C (-40° to 158°F)
	Humidity	10% to 90%, RHL non-condensing

Regulatory Compliance	Safety	CE, UL, UKCA
	Environmental	RoHs, WEEE
Enclosure	Size	Mega Tool
	Type	Aluminum
	Cooling	Convection Ventilation
General	Net Dimensions (W, D, H)	19cm x 11.6cm x 2.7cm (7.5" x 4.6" x 1.1")
	Shipping Dimensions (W, D, H)	34.5cm x 16.5cm x 5.2cm (13.6" x 6.5" x 2")
	Net Weight	0.56kg (1.24lbs)
	Shipping Weight	1.15kg (2.5lbs) approx.
Accessories	Included	20V DC 6A Power adapter and cord, USB-C multi-signal cable
Specifications are subject to change without notice at www.kramerav.com		

Default Communication Parameters

RS-232	
Baud Rate:	115,200
Data Bits:	8
Stop Bits:	1
Parity:	None
Command Format:	ASCII
Example (Route video input 2 to the output):	#ROUTE_1,1,2<CR>
Ethernet	
To reset the IP settings to the factory reset values go to: Menu->Setup -> Factory Reset-> press Enter to confirm	
Fallback IP Address:	192.168.1.39
Fallback Subnet mask:	255.255.255.0
Fallback gateway:	192.168.0.1
Default username:	Admin
Default password:	Admin
Full Factory Reset	
P3K	<p>"#FACTORY" command.</p> <p>After receiving "FACTORY OK" perform one of the following to restart the device and complete the procedure:</p> <ul style="list-style-type: none"> • Power cycle • Send command "#RESET"
Embedded webpages	Go to: Device>General and click FACTORY RESET

Protocol 3000

Kramer devices can be operated using Kramer Protocol 3000 commands sent via serial or Ethernet ports.

Understanding Protocol 3000

Protocol 3000 commands are a sequence of ASCII letters, structured according to the following.

- **Command format:**

Prefix	Command Name	Constant (Space)	Parameter(s)	Suffix
#	Command	_	Parameter	<CR>

- **Feedback format:**

Prefix	Device ID	Constant	Command Name	Parameter(s)	Suffix
~	nn	@	Command	Parameter	<CR><LF>

- **Command parameters** – Multiple parameters must be separated by a comma (,). In addition, multiple parameters can be grouped as a single parameter using brackets ([and]).
- **Command chain separator character** – Multiple commands can be chained in the same string. Each command is delimited by a pipe character (|).
- **Parameters attributes** – Parameters may contain multiple attributes. Attributes are indicated with pointy brackets (<...>) and must be separated by a period (.).

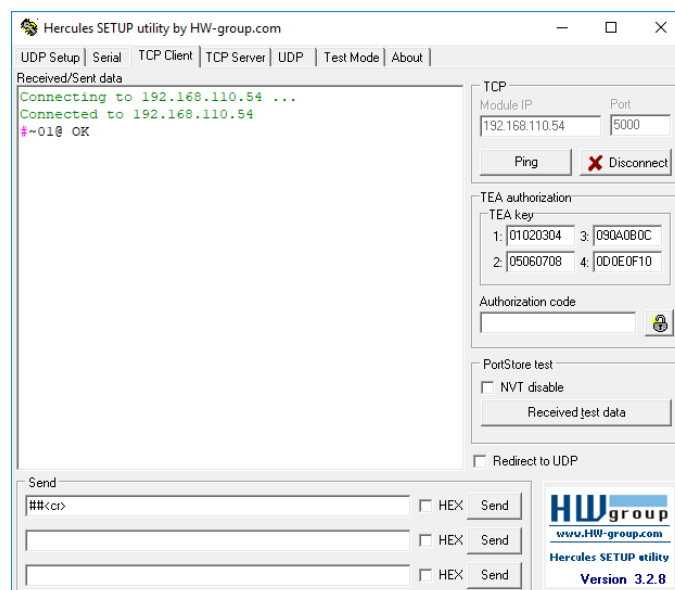

The command framing varies according to how you interface with **SWT3-31-HU**. The following figure displays how the # command is framed using terminal communication software (such as Hercules):



Protocol 3000 Commands

Function	Description	Syntax	Parameters/Attributes	Example
#	Protocol handshaking. ① Validates the Protocol 3000 connection and gets the machine number. Step-in master products use this command to identify the availability of a device.	COMMAND #<CR> FEEDBACK ~nn@_ok<CR><LF>		#<CR>
AUD-LVL	Set volume level.	COMMAND #AUD-LVL_ io_mode,io_index,vol_level<CR> FEEDBACK ~nn@AUD-LVL_ io_mode,io_index,vol_level<CR><LF>	io_mode – 1 – Output io_index – 1 vol_level – Volume level -100db to 15dB; ++ (increase current value by 1dB); -- (decrease current value by 1dB)	Set AUDIO OUT level to -50.0dB: #AUD-LVL_1,1,-50.0<CR>
AUD-LVL?	Get volume level.	COMMAND #AUD-LVL?_ io_mode,io_index<CR> FEEDBACK ~nn@AUD-LVL_ io_mode,io_index,vol_level<CR><LF>	io_mode – 1 – Output io_index – 1 vol_level – Volume level -100db to 15dB;	Get AUDIO OUT level: #AUD-LVL?_1,1,1<CR>
AUD-LVL-RANGE?	Get volume level min and max range.	COMMAND #AUD-LVL-RANGE?_ io_mode,io_index<CR> FEEDBACK ~nn@AUD-LVL-RANGE_ io_mode,io_index,min_val,max_val<CR><LF>	io_mode – 1 – Output io_index – 1 min_val – -100db max_val – 15dB	Get AUDIO OUT level range: #AUD-LVL-RANGE?_1,1,1<CR>
AUD-MUTE	Set audio mute state for Audio ports	COMMAND #AUD-MUTE_ in_out,channel,mute_type,mute_state<CR> FEEDBACK ~nn@AUD-MUTE_ in_out,channel,mute_type,mute_state<CR><LF>	in_out : Port Direction 0 – In 1 – Out Channel : audio channel ID ChannelID for input 1 Front input 3.5 LEFT or output Analog LEFT 2 Front input 3.5 RIGHT or output Analog RIGHT 3 Analog in 2 4 Analog in 3 RIGHT 5 Analog in 4 6 Analog in 5 7 USB LEFT 8 USB RIGHT 9 HDMI LEFT 10 HDMI RIGHT 11 ARC LEFT 12 ARC RIGHT 13 Generator Channel ID for Output: 1 output Analog LEFT 2 output Analog LEFT 3 USB output LEFT 4 USB Output RIGHT mute_type : Audio Mute 0 – INPUT MUTE 1 – INPUT post mute or output mute mute_state : Mute State 0 – UNUTE 1 – MUTE	Set Audio Mute of Analog Output one: #AUD-MUTE_1,1,1,1<CR>
AUD-MUTE?	Get Audio Mute state for Audio ports	COMMAND #AUD-MUTE_ in_out,channel,mute_type<CR> FEEDBACK ~nn@AUD-MUTE_ in_out_channel,mute_type<CR><LF>	out_index –1 in_out : Port Direction 0 – In 1 – Out Channel : audio channel ID ChannelID for input 1 Front input 3.5 LEFT or output Analog LEFT 2 Front input 3.5 RIGHT or output Analog RIGHT 3 Analog in 2 4 Analog in 3 RIGHT 5 Analog in 4 6 Analog in 5 7 USB LEFT 8 USB RIGHT 9 HDMI LEFT 10 HDMI RIGHT 11 ARC LEFT 12 ARC RIGHT 13 Generator Channel ID for Output: 1 output Analog LEFT 2 output Analog LEFT 3 USB output LEFT 4 USB Output RIGHT mute_type : Audio Mute 0 – INPUT MUTE 1 – INPUT post mute or output mute	Get Audio Mute state of Analog Output one #AUD-MUTE?_1,1,1,1<CR>

Function	Description	Syntax	Parameters/Attributes	Example
AUD-MUTE-PERSIST	Set the auto audio unmute status upon volume change.	COMMAND #AUD-MUTE-PERSIST_unmute_status<CR> FEEDBACK ~nn@AUD-MUTE-PERSIST_unmute_status<CR><LF>	unmute_status – 0 – Mute state is not persistent and changes upon volume change 1 – Mute state is persistent upon volume change	Set mute mode to be persistent and not change upon volume change: #AUD-MUTE-PERSIST_1<CR>
AUD-MUTE-PERSIST?	Get the auto audio unmute status.	COMMAND #AUD-MUTE-PERSIST?_<CR> FEEDBACK ~nn@AUD-MUTE-PERSIST_unmute_status<CR><LF>	unmute_status – 0 – Mute state is not persistent and changes upon volume change 1 – Mute state is persistent upon volume change	Get auto unmute status upon volume change: #AUD-MUTE-PERSIST?_<CR>
AUTH-802-1X-ENABLE	Set authentication 802.1X feature for the specific interface.	COMMAND #AUTH-802-1X-ENABLE_interface,enable_status<CR> FEEDBACK ~nn@AUTH-802-1X-ENABLE_interface,enable_status<CR><LF>	interface – Interface ID – 0 enable_status – 0 – Off 1 – On	Set the authentication 802.1X feature on: #AUTH-802-1X-ENABLE_0,1<CR>
AUTH-802-1X-ENABLE?	Get authentication 802.1X feature for the specific interface.	COMMAND #AUTH-802-1X-ENABLE?_interface<CR> FEEDBACK ~nn@AUTH-802-1X-ENABLE_interface,enable_status<CR><LF>	interface – Interface ID – 0 enable_status – 0 – Off 1 – On	Get the authentication 802.1X feature status: #AUTH-802-1X-ENABLE?_0<CR>
AV-SW-MODE	Set input auto switch mode (per output).	COMMAND #AV-SW-MODE_layer_type,out_index,connection_mode<CR> FEEDBACK ~nn@AV-SW-MODE_layer_type,out_index,connection_mode<CR><LF>	layer_type – Number that indicates the signal type: 1 – Video 2 – Audio out_index – 1 connection_mode – Connection mode 0 – manual 1 – priority switch 2 – last connected switch	Set the input audio switch mode to Manual for HDMI OUT: #AV-SW-MODE_1,1,0<CR>
AV-SW-MODE?	Get input auto switch mode (per output).	COMMAND #AV-SW-MODE?_layer_type,out_index<CR> FEEDBACK ~nn@AV-SW-MODE_layer_type,out_index,connection_mode<CR><LF>	layer_type – Number that indicates the signal type: 1 – Video 2 – Audio out_index – 1 connection_mode – Connection mode 0 – manual 1 – priority switch 2 – last connected switch	Get the input audio switch mode for HDMI OUT: #AV-SW-MODE?_1,1<CR>
AV-SW-TIMEOUT	Set auto switching timeout.	COMMAND #AV-SW-TIMEOUT_switching_mode,time_out<CR> FEEDBACK ~nn@AV-SW-TIMEOUT_switching_mode,time_out<CR><LF>	switching_mode – Switching mode 0 – Video signal lost 1 – New video signal detected 4 – Disable 5V on video output if no input signal detected 5 – Video cable unplugged 7 – Video signal lost for signal routed as a result of a manual override action time_out – Timeout in seconds 0 - 60000	Set the auto switching timeout to 5 seconds in the event of 5V disable when no input signal is detected: #AV-SW-TIMEOUT_4,5<CR>
AV-SW-TIMEOUT?	Set auto switching timeout.	COMMAND #AV-SW-TIMEOUT?_switching_mode<CR> FEEDBACK ~nn@AV-SW-TIMEOUT_switching_mode,time_out<CR><LF>	switching_mode – Switching mode 0 – Video signal lost 1 – New video signal detected 4 – Disable 5V on video output if no input signal detected 5 – Video cable unplugged 7 – Video signal lost for signal routed as a result of a manual override action time_out – Timeout in seconds 0 - 60000	Get the auto switching timeout in the event of 5V disable when no input signal is detected: #AV-SW-TIMEOUT?_4<CR>
BEACON-INFO?	Get beacon information, including IP address, UDP control port, TCP control port, MAC address, model, name.	COMMAND #BEACON-INFO?_<CR> FEEDBACK ~nn@BEACON-INFO_port_id,ip_string,udp_port,tcp_port,mac_address,model,name<CR><LF>	port_id – ID of the Ethernet port ip_string – Dot-separated representation of the IP address udp_port – UDP control port tcp_port – TCP control port mac_address – Dash-separated mac address model – Device model name – Device name	Get beacon information: #BEACON-INFO?_<CR>
BUILD-DATE?	Get device build date.	COMMAND #BUILD-DATE?_<CR> FEEDBACK ~nn@BUILD-DATE_date,time<CR><LF>	date – Format: YYYY/MM/DD where YYYY = Year MM = Month DD = Day time – Format: hh:mm:ss where hh = hours mm = minutes ss = seconds	Get the device build date: #BUILD-DATE?<CR>
CEC-GW-PORT-ACTIVE	Set the CEC activation state.	COMMAND #CEC-GW-PORT-ACTIVE_direction_type,port_format,port_index,state<CR> FEEDBACK ~nn@CEC-GW-PORT-ACTIVE_direction_type,port_format,port_index,state<CR><LF>	direction_type – Direction of the port: out port_format – Type of signal on the port: hdbt port_index – The port number: 1 state – Global gateway activation state: o 0 – as a passthrough o 1 – as a gateway	Activate CEC for the HDBaseT port as a passthrough: #CEC-GW-PORT-ACTIVE_in,hdbt,1,0<CR>

Function	Description	Syntax	Parameters/Attributes	Example
CEC-GW-PORT-ACTIVE?	Get the CEC activation state.	COMMAND #CEC-GW-PORT-ACTIVE?_direction_type,port_format,port_index<CR> FEEDBACK ~nn@CEC-GW-PORT-ACTIVE_direction_type,port_format,port_index,state<CR><LF>	direction_type – Direction of the port: out port_format – Type of signal on the port: hdbt port_index – The port number: 1 state – Global gateway activation state: o 0 – as a passthrough o 1 – as a gateway	Get the Activate CEC status for the HDBaseT port as a passthrough: #CEC-GW-PORT-ACTIVE_1,hdmi,1<CR>
CEC-MEMBERS?	Get list of CEC logical addresses.	COMMAND #CEC-MEMBERS?_port_index<CR> FEEDBACK ~nn@CEC-MEMBERS_port_index,<la1>,<la2>...<CR><LF>	port_index – 1 la – 1 to 15	Set gateway members: #CEC-MEMBERS?_1<CR>
CEC-NTFY-ACTIVE	Set CEC notification activity (valid until the next power up).	COMMAND #CEC-NTFY-ACTIVE_cec_ntf<CR> FEEDBACK ~nn@CEC-NTFY-ACTIVE_cec_ntf<CR><LF>	cec_ntf – 0 – Inactive 1 – Active	Enable CEC notification: #CEC-NTFY-ACTIVE_1<CR>
CEC-NTFY-ACTIVE?	Get CEC notification activity status.	COMMAND #CEC-NTFY-ACTIVE?_<CR> FEEDBACK ~nn@CEC-NTFY-ACTIVE_cec_ntf<CR><LF>	cec_ntf – 0 – Inactive 1 – Active	Get CEC notification activity status: #CEC-NTFY-ACTIVE?_<CR>
CEC-SND	Send CEC command to port.	COMMAND #CEC-SND_port_index,sn_id,cmd_name,cec_len,cec_command<CR> FEEDBACK ~nn@CEC-SND_port_index,sn_id,cmd_name,cec_mode<CR><LF>	port_index – CEC port transmitting the command: 1 sn_id – 1 cmd_name – command name cec_len – 1-16 cec_command – CEC format command (in HEX format, no leading zeros, no '0x' prefix) cec_mode – CEC mode 0 – Sent 1 – Gateway disabled 2 – Inactive CEC-Master 3 – Busy 4 – Illegal Message Parameter 5 – Illegal CEC Address Parameter 6 – Illegal CEC Command 7 – Timeout 8 – Error	Send TV-OFF CEC command to the HDBaseT port: #CEC-SND_1,1,TV-OFF,2,e004<CR>
COM-ROUTE?	Get tunneling port routing.  This command sets tunneling port routing. Every com port can send or receive data from the ETH port. Set command can edit an existing configuration.	COMMAND #COM-ROUTE?_com_id<CR> FEEDBACK ~nn@COM-ROUTE_com_id,port_type,port_id,eth_rep_en,ping_val<CR><LF>	com_id – Machine dependent, * (get all route tunnels) port_type – TCP/UDP 0 – TCP 1 – UDP port_id – TCP/UDP port number eth_rep_en – Ethernet Reply 0 – COM port does not send replies to new clients 1 – COM port sends replies to new clients. ping_val – Send an empty string to TCP client every 0 to 3600 seconds. 0 - 3600	Get tunneling port routing for all route tunnels: #COM-ROUTE?_*<CR>
COUNTER?	Get the sent or received CEC messages count.	COMMAND #COUNTER?_category_id,sub_category_id<CR> FEEDBACK ~nn@COUNTER_category_id,sub_category_id,count<CR><LF>	category_id – CEC messages: 0 Sub_category_id – Type of message: 0 – Sent message 1 – Received message count – Number range: 0-65535	Get the number of sent messages: #COUNTER?_0,0<CR>
COUNTER-CLR	Clear CEC messages.	COMMAND #COUNTER-CLR?_category_id,sub_category_clr<CR> FEEDBACK ~nn@COUNTER-CLR_category_id,sub_category_id,count<CR><LF>	category_id – CEC messages: 0 Sub_category_clr – Type of message to clear: 0 – Clear sent messages 1 – Clear received messages * – Clear all CEC messages	Clear all CEC messages: #COUNTER-CLR?_0,*<CR>
CPEDID	Copy EDID data from the output to the input EEPROM.  Destination bitmap size depends on device properties (for 64 inputs it is a 64-bit word). Example: bitmap 0x0013 means inputs 1,2 and 5 are loaded with the new EDID. In certain products Safe_mode is an optional parameter. See the HELP command for its availability.	COMMAND #CPEDID_edid_io,src_id,edid_io,dest_bitmap<CR> or #CPEDID_edid_io,src_id,edid_io,dest_bitmap,safe_mode<CR> FEEDBACK ~nn@CPEDID_edid_io,src_id,edid_io,dest_bitmap<CR><LF> ~nn@CPEDID_edid_io,src_id,edid_io,dest_bitmap,safe_mode<CR><LF>	edid_io – EDID source type (usually output) 0 – Input 1 – Output 2 – Default EDID 3 – Custom EDID src_id – Number of chosen source stage 0 – Default EDID source 1 – HDBaseT OUT or USB-C IN 2 – HDMI IN edid_io – EDID destination type 0 – Input dest_bitmap – Bitmap representing destination IDs. Format: XXXX...X, where X is hex digit. The binary form of every hex digit represents corresponding destinations. 0 – indicates that EDID data is not copied to this destination. 1 – indicates that EDID data is copied to this destination. safe_mode – Safe mode (optional parameter) 0 – device accepts the EDID as is without trying to adjust (default value if no parameter is sent) 1 – device tries to adjust the EDID	Copy the EDID data from the HDBaseT Output to the HDMI Input: #CPEDID_1,1,0,0x1<CR>

Function	Description	Syntax	Parameters/Attributes	Example
CS-CONVERT	Set the "force RGB color space" convert mode.	COMMAND #CS-CONVERT_<out_index>,cs_mode<CR> FEEDBACK ~nn@CS-CONVERT_<out_index>,cs_mode<CR><LF>'	out_index – The port number: 1 cs_mode – color space mode: o 0 – Color space pass (default) o 1 – Enable "force RGB color space" convert mode	Enable force RGB color space: #CS-CONVERT_1,1<CR>
CS-CONVERT?	Get the "force RGB color space" convert mode.	COMMAND #CS-CONVERT?_<out_index><CR> FEEDBACK ~nn@CS-CONVERT_<out_index>,cs_mode<CR><LF>'	out_index – The port number: 1 cs_mode – color space mode: o 0 – Color space pass (default) o 1 – Enable "force RGB color space" convert mode	Get force RGB color space mode: #CS-CONVERT?_1<CR>
DEV-STATE?	Get the device state.	COMMAND #DEV-STATE?_<CR> FEEDBACK ~nn@DEV-STATE_<dev_state><CR><LF>'	dev_state – device state 0 – Active 1 – Power-on and no connected AV I/O ports (detecting cable connection faults) 2 – Power-on and standby (low power; cables are either connected or not)	Get device status: #DEV-STATE?_<CR>
DISPLAY?	Get output HPD status.	COMMAND #DISPLAY?_<out_index><CR> FEEDBACK ~nn@DISPLAY_<out_index>,status<CR><LF>	out_index – Number that indicates the specific output: 1 status – HPD status according to signal validation 0 – Signal or sink is not valid 1 – Signal or sink is valid 2 – Sink and EDID is valid	Get the output HPD status of Output 1: #DISPLAY?_1<CR>
EDID-AUDIO	Set audio capabilities for EDID.	COMMAND #EDID-AUDIO_<direction_type>.<port_format>.<port_index>.<signal_type>.<index>,audio_format<CR> FEEDBACK ~nn@EDID-AUDIO_<direction_type>.<port_format>.<port_index>.<signal_type>.<index>,audio_format<CR><LF>	The following attributes comprise the signal ID: <ul style="list-style-type: none"> ▪ <direction_type> – Direction of the port: o IN – Input o OUT – Output ▪ <port_format> – Type of signal on the port: o HDMI o ANALOG_AUDIO o USB_C ▪ <port_index> – The port number as printed on the front or rear panel ▪ <signal_type> – Signal ID attribute: o AUDIO ▪ <index> – Indicates a specific channel number when there are multiple channels of the same type audio_format – Audio block added to EDID: 0 – Auto 1 – LPCM 2CH 2 – LPCM 6CH 3 – LPCM 8CH 4 – Bitstream 5 – HD	Set HDMI IN 2 audio capabilities for EDID (LPCM 6CH): #EDID-AUDIO_in.hdmi.2.audio.1,2<CR>
EDID-AUDIO?	Get audio capabilities for EDID.	COMMAND #EDID-AUDIO?_<direction_type>.<port_format>.<port_index>.<signal_type>.<index><CR> FEEDBACK ~nn@EDID-AUDIO_<audio_format><CR><LF>	The following attributes comprise the signal ID: <ul style="list-style-type: none"> ▪ <direction_type> – Direction of the port: o IN – Input o OUT – Output ▪ <port_format> – Type of signal on the port: o HDMI o ANALOG_AUDIO o USB_C ▪ <port_index> – The port number as printed on the front or rear panel ▪ <signal_type> – Signal ID attribute: o AUDIO ▪ <index> – Indicates a specific channel number when there are multiple channels of the same type audio_format – Audio block added to EDID: 0 – Auto 1 – LPCM 2CH 2 – LPCM 6CH 3 – LPCM 8CH 4 – Bitstream 5 – HD	Get HDMI IN 2 audio capabilities for EDID: #EDID-AUDIO?_in.hdmi.2.audio.1,2<CR>
EDID-DC	Force removal of deep color on EDID or leaving it as in the original EDID.	COMMAND #EDID-DC_<in_index>,deep_color_state<CR> FEEDBACK ~nn@EDID-DC_<in_index>,deep_color_state<CR><LF>	in_index – Number that indicates the specific input: 1 – Input 1 2 – Input 2 deep_color_state – 0 – Don't change 1 – Remove deep color	Remove deep color on EDID for input 1. #EDID-DC_1,1<CR>

Function	Description	Syntax	Parameters/Attributes	Example
EDID-DC?	Get deep color status on EDID.	COMMAND #EDID-DC?_in_index <CR> FEEDBACK ~nn@EDID-DC_in_index,deep_color_state<CR><LF>	in_index – Number that indicates the specific input: 1 – Input 1 2 – Input 2 deep_color_state – 0 – Don't change 1 – Remove deep color	Get deep color state on EDID for input 2. #EDID-DC?_2<CR>
ETH-PORT	Set Ethernet port protocol. ⓘ If the port number you enter is already in use, an error is returned. The port number must be within the following range: 0-(2 ¹⁶ -1).	COMMAND #ETH-PORT_port_type,port_id<CR> FEEDBACK ~nn@ETH-PORT_port_type,port_id<CR><LF>	port_type – TCP/UDP port_id – TCP/UDP port number (0 – 65535)	Set the Ethernet port protocol for TCP to 12457: #ETH-PORT_TCP,12457<CR>
ETH-PORT?	Get Ethernet port protocol. ⓘ If the port number you enter is already in use, an error is returned. The port number must be within the following range: 0-(2 ¹⁶ -1).	COMMAND #ETH-PORT?_port_type<CR> FEEDBACK ~nn@ETH-PORT?_port_type,port_id<CR><LF>	port_type – TCP/UDP port_id – TCP/UDP port number (0 – 65535)	Get the Ethernet port protocol for UDP: #ETH-PORT?_UDP<CR>
ETH-TUNNEL?	Get an open tunnel parameters.	COMMAND #ETH-TUNNEL?_tunnel_id<CR> FEEDBACK ~nn@ETH-TUNNEL_tunnel_id,cmd_name,port_type,port_id,eth_ip,remote_port_id,eth_rep_en,connection_type<CR><LF>	tunnel_id – Tunnel ID number, * (get all open tunnels) cmd_name – UART number port_type – TCP/UDP 0 – TCP 1 – UDP port_id – TCP/UDP port number eth_ip – Client IP address remote_port_id – Remote port number eth_rep_en – Ethernet Reply 0 – COM port does not send replies to new clients 1 – COM port sends replies to new clients connection_type – Connection type 0 – not wired connection 1 – wired connection	Set baud rate to 9600, 8 data bits, parity to none and stop bit to 1: #ETH-TUNNEL?*<CR>
FACTORY	Reset device to factory default configuration. ⓘ This command deletes all user data from the device. The deletion can take some time. Your device may require powering off and powering on for the changes to take effect.	COMMAND #FACTORY<CR> FEEDBACK ~nn@FACTORY_ok<CR><LF>		Reset the device to factory default configuration: #FACTORY<CR>
FW-TYPE?	Get the current FW type status. Used by Kramer Network and KUpload to identify recovery process.	COMMAND #FW-TYPE?_<CR> FEEDBACK ~nn@FEATURE-LIST_fw_type<CR><LF>	Fw_type – 0 – Application 1 – Safe mode (kboot)	Get the current FW type status: #FW-TYPE?_<CR>
GLOBAL-GW-ACTIVE	Set global gateway to active / inactive.	COMMAND #GLOBAL-GW-ACTIVE_status<CR> FEEDBACK ~nn@GLOBAL-GW-ACTIVE_status<CR><LF>	status – On/Off ON – Active Off – Inactive	Set global gateway off: #AUDIO-BYPASS_OFF<CR>
GLOBAL-GW-ACTIVE?	Set global gateway to active / inactive.	COMMAND #GLOBAL-GW-ACTIVE?<CR> FEEDBACK ~nn@GLOBAL-GW-ACTIVE_status<CR><LF>	status – On/Off ON – Active Off – Inactive	Get global gateway off: #AUDIO-BYPASS?<CR>
GPIO-CFG	Set HW GPIO configuration.	COMMAND #GPIO-CFG_gpio_id,gpio_type,gpio_dir,pullup<CR> FEEDBACK ~nn@GPIO-CFG_gpio_id,gpio_type,gpio_dir<CR><LF>	gpio_id – Hardware GPIO number (1-2) gpio_type – Hardware GPIO type 0 – analog 1 – digital gpio_dir – Hardware GPIO direction 0 – input 1 – output pullup – Enable/Disable pull-up 0 – disable 1 – enable	Set HW GPIO 1 configuration: #GPIO-CFG_1,1,1,1<CR>
GPIO-CFG?	Get HW GPIO configuration.	COMMAND #GPIO-CFG?_gpio_id<CR> FEEDBACK ~nn@GPIO-CFG_gpio_id,gpio_type,gpio_dir<CR><LF>	gpio_id – Hardware GPIO number (1-2) gpio_type – Hardware GPIO type 0 – analog 1 – digital gpio_dir – Hardware GPIO direction 0 – input 1 – output pullup – Enable/Disable pull-up 0 – disable 1 – enable	Get HW GPIO configuration: #GPIO-CFG?_1<CR>

Function	Description	Syntax	Parameters/Attributes	Example
GPIO-STATE	<p>Set HW GPIO state.</p> <p>i GPIO-STATE? can only be set in digital out mode and the answer is 0=Low, 1=High. In all other modes an error message is sent.</p> <p>The device uses this command to notify the user of any change regarding the step and voltage in:</p> <p>In digital mode the answer is 0 (low), 1 (high).</p> <p>In analog mode the answer is 0 to 100.</p>	<p>COMMAND</p> <pre>#GPIO-STATE_gpio_id, gpio_mode<CR></pre> <p>FEEDBACK</p> <pre>~nn@GPIO-STATE_gpio_id, gpio_mode<CR><LF></pre>	<p>gpio_id – Hardware GPIO number (1-2)</p> <p>gpio_mode – Hardware GPIO state</p> <p>0 – Low</p> <p>1 – High</p>	<p>Set GPIO 2 to High:</p> <pre>#GPIO-STATE_2, 1<CR></pre>
GPIO-STATE?	<p>Get HW GPIO state.</p> <p>i GPIO-STATE? can only be set in digital out mode and the answer is 0=Low, 1=High. In all other modes an error message is sent.</p> <p>The device uses this command to notify the user of any change regarding the step and voltage in:</p> <p>In digital mode the answer is 0 (low), 1 (high).</p> <p>In analog mode the answer is 0 to 100.</p>	<p>COMMAND</p> <pre>#GPIO-STATE?_gpio_id<CR></pre> <p>FEEDBACK</p> <pre>~nn@GPIO-STATE_gpio_id, gpio_mode<CR><LF></pre>	<p>gpio_id – Hardware GPIO number (1-2)</p> <p>gpio_mode – Hardware GPIO state</p> <p>0 – Low</p> <p>1 – High</p>	<p>Get GPIO 2 state:</p> <pre>#GPIO-STATE?_2<CR></pre>
GPIO-STEP	<p>Set HW GPIO step.</p> <p>i In digital mode the response is 2.</p> <p>In analog mode the response is 1 to 100.</p> <p>In other modes an error is returned.</p>	<p>COMMAND</p> <pre>#GPIO-STEP_gpio_id, step_id<CR></pre> <p>FEEDBACK</p> <pre>~nn@GPIO-STEP_gpio_id, step_id, currentstep<CR><LF></pre>	<p>gpio_id – HW GPIO number (1-2)</p> <p>step_id – The configuration step – See note in description.</p> <p>currentstep – The actual step depending on the measured voltage</p>	<p>Set GPIO 2 (set to Analog In) configuration step to 38mV:</p> <pre>#GPIO-STEP_2, 38<CR></pre>
GPIO-STEP?	<p>Get HW GPIO step.</p> <p>i In digital mode the response is 2.</p> <p>In analog mode the response is 1 to 100.</p> <p>In other modes an error is returned.</p>	<p>COMMAND</p> <pre>#GPIO-STEP?_gpio_id<CR></pre> <p>FEEDBACK</p> <pre>~nn@GPIO-STEP_gpio_id, step_id, currentstep<CR><LF></pre>	<p>gpio_id – HW GPIO number (1-2)</p> <p>step_id – The configuration step – See note in description.</p> <p>currentstep – The actual step depending on the measured voltage</p>	<p>Get GPIO 2 configuration:</p> <pre>#GPIO-STEP?_2<CR></pre>
GPIO-THR	<p>Set HW GPIO voltage levels.</p>	<p>COMMAND</p> <pre>#GPIO-THR_gpio_id, low_level, high_level<CR></pre> <p>FEEDBACK</p> <pre>~nn@GPIO-THR_gpio_id, low_level, high_level<CR><LF></pre>	<p>gpio_id – Hardware GPIO number (1-2)</p> <p>low_level – Voltage 500 to 28000 millivolts</p> <p>high_level – Voltage 2000 to 30000 millivolts</p>	<p>Set GPIO 2 to a low level of 800mV and a high level of 2200mV:</p> <pre>#GPIO-THR_2, 800, 2200<CR></pre>
GPIO-THR?	<p>Get HW GPIO voltage levels that were set.</p>	<p>COMMAND</p> <pre>#GPIO-THR?_gpio_id<CR></pre> <p>FEEDBACK</p> <pre>~nn@GPIO-THR_gpio_id, low_level, high_level<CR><LF></pre>	<p>gpio_id – Hardware GPIO number (1-2)</p> <p>low_level – Voltage 500 to 28000 millivolts</p> <p>high_level – Voltage 2000 to 30000 millivolts</p>	<p>Get GPIO 2:</p> <pre>#GPIO-THR?_2<CR></pre>
GPIO-VOLT?	<p>Get active voltage levels of HW GPIO.</p> <p>i This command is not available in digital out mode.</p>	<p>COMMAND</p> <pre>GPIO-VOLT?_gpio_id<CR></pre> <p>FEEDBACK</p> <pre>~nn@GPIO-VOLT_gpio_id, voltage<CR><LF></pre>	<p>gpio_id – Hardware GPIO number (1-2)</p> <p>voltage – Voltage 0 to 30000 millivolts</p>	<p>Get GPIO 1 voltage:</p> <pre>#GPIO-VOLT?_1<CR></pre>
HDCP-MOD	<p>Set HDCP mode.</p> <p>i Get HDCP working mode on the device input:</p> <p>HDCP supported – HDCP ON [default].</p> <p>HDCP not supported - HDCP OFF.</p> <p>HDCP support changes following detected sink - MIRROR OUTPUT.</p>	<p>COMMAND</p> <pre>#HDCP-MOD_in_index, mode<CR></pre> <p>FEEDBACK</p> <pre>~nn@HDCP-MOD_in_index, mode<CR><LF></pre>	<p>in_index – Number that indicates the specific input:</p> <p>1 – USB-C IN</p> <p>2 – HDMI IN</p> <p>mode – HDCP mode:</p> <p>0 – HDCP Off</p> <p>1 – HDCP On</p> <p>2 – Follow Input</p> <p>3 – HDCP defined according to the connected output</p>	<p>Set the input HDCP-MODE of HDMI IN to off:</p> <pre>#HDCP-MOD_2, 0<CR></pre>

Function	Description	Syntax	Parameters/Attributes	Example
HDCCP-MOD?	<p>Get HDCP mode.</p> <p>ⓘ Get HDCP working mode on the device input:</p> <p>HDCP supported – HDCP ON [default].</p> <p>HDCP not supported - HDCP OFF.</p> <p>HDCP support changes following detected sink - MIRROR OUTPUT.</p>	<p>COMMAND</p> <pre>#HDCCP-MOD?_in_index<CR></pre> <p>FEEDBACK</p> <pre>~nn@HDCCP-MOD_in_index,mode<CR><LF></pre>	<p>in_index – Number that indicates the specific input:</p> <ul style="list-style-type: none"> 1 – USB-C IN 2 – HDMI IN <p>mode – HDCP mode:</p> <ul style="list-style-type: none"> 0 – HDCP Off 1 – HDCP On 2 – Follow Input 3 – HDCP defined according to the connected output 	<p>Get the input HDCP-MODE of HDMI IN :</p> <pre>#HDCCP-MOD?_2<CR></pre>
HDCCP-OUT	<p>Set HDCP mode.</p> <p>ⓘ Get HDCP working mode on the device input:</p> <p>HDCP supported – HDCP ON [default].</p> <p>HDCP not supported - HDCP OFF.</p> <p>HDCP support changes following detected sink - MIRROR OUTPUT.</p>	<p>COMMAND</p> <pre>#HDCCP-OUT_out_index,mode<CR></pre> <p>FEEDBACK</p> <pre>~nn@HDCCP-OUT_out_index,mode<CR><LF></pre>	<p>out_index – Number that indicates the specific input:</p> <ul style="list-style-type: none"> 1 – HDBaset OUT <p>mode – HDCP mode:</p> <ul style="list-style-type: none"> 0 – Follow Input 1 – HDCP always ON (i.e. output signal is always HDCP-encrypted, regardless of input HDCP) 	<p>Set the output HDCP mode of HDBaset OUT to follow input:</p> <pre>#HDCCP-OUT_1,0<CR></pre>
HDCCP-OUT?	<p>Get HDCP mode.</p> <p>ⓘ Get HDCP working mode on the device input:</p> <p>HDCP supported – HDCP ON [default].</p> <p>HDCP not supported - HDCP OFF.</p> <p>HDCP support changes following detected sink - MIRROR OUTPUT.</p>	<p>COMMAND</p> <pre>#HDCCP-OUT?_out_index<CR></pre> <p>FEEDBACK</p> <pre>~nn@HDCCP-OUT_out_index,mode<CR><LF></pre>	<p>out_index – Number that indicates the specific input:</p> <ul style="list-style-type: none"> 1 – HDBaset OUT <p>mode – HDCP mode:</p> <ul style="list-style-type: none"> 0 – Follow Input 1 – HDCP always ON (i.e. output signal is always HDCP-encrypted, regardless of input HDCP) 	<p>Get the output HDCP-MODE of HDBaset OUT :</p> <pre>#HDCCP-OUT?_1<CR></pre>
HDCCP-STAT?	<p>Get HDCP signal status of a connected device.</p> <p>ⓘ io_mode =1 – get the HDCP signal status of the sink device connected to the specified output.</p> <p>io_mode =0 – get the HDCP signal status of the source device connected to the specified input.</p>	<p>COMMAND</p> <pre>#HDCCP-STAT?_io_mode,in_index<CR></pre> <p>FEEDBACK</p> <pre>~nn@HDCCP-STAT_io_mode,in_index,status<CR><LF></pre>	<p>io_mode – Input/Output</p> <ul style="list-style-type: none"> 0 – Input 1 – Output <p>io_index – Number that indicates the specific number of inputs or outputs (based on io_mode):</p> <ul style="list-style-type: none"> 1 – HDBaset OUT or USB-C IN 2 – HDMI IN <p>status – Signal encryption status - valid values On/Off:</p> <ul style="list-style-type: none"> 0 – HDCP Off 1 – HDCP On 	<p>Get the HDCP status of the source device connected to USB-C IN:</p> <pre>#HDCCP-STAT?_0,1<CR></pre>
HELP	<p>Get command list or help for specific command.</p>	<p>COMMAND</p> <pre>#HELP<CR></pre> <pre>#HELP_cmd_name<CR></pre> <p>FEEDBACK</p> <p>1. Multi-line:</p> <pre>~nn@Device_cmd_name,_cmd_name..<CR><LF></pre> <p>To get help for command use: HELP (COMMAND_NAME)<CR><LF></p> <pre>~nn@HELP_cmd_name:<CR><LF></pre> <pre>description<CR><LF></pre> <pre>USAGE:usage<CR><LF></pre>	<p>cmd_name – Name of a specific command</p>	<p>Get the command list:</p> <pre>#HELP<CR></pre> <p>To get help for AV-SW-TIMEOUT:</p> <pre>HELP_av-sw-timeout<CR></pre>
IDV	<p>Set visual indication from device.</p> <p>ⓘ Using this command, some devices can light a sequence of buttons or LEDs to allow identification of a specific device from similar devices.</p>	<p>COMMAND</p> <pre>#IDV<CR></pre> <p>FEEDBACK</p> <pre>~nn@IDV_ok<CR><LF></pre>		<pre>#IDV<CR></pre>

Function	Description	Syntax	Parameters/Attributes	Example
IR-SND	Send IR command to port.	COMMAND #IR-SND _{ir_index,sn_id,cmd_name,repeat_amount,total_packages,package_id,<pronto command.>} <CR> FEEDBACK ~nn@IR-SND _{ir_index,sn_id,cmd_name,ir_status} <CR><LF>	ir_index – Number that indicates the specific ir port: 1-N (N= the total number of inputs) * - broadcasts to all ports sn_id – Serial number of command for flow control and response commands from device cmd_name – Command name (length limit 15 chars) repeat_amount – Of times the IR command is transmitted (limited to 50; repeats > 50 are truncated to 50), default = 1 total_packages – Number of messages the original command was divided into, default = 1 package_id – Chunk serial number (only valid when <i>Total_packages</i> >1) pronto_command – Pronto format command (in HEX format, no leading zeros, no '0x' prefix) ir_status – IR Status 0 – Sent (no error) 1 – Stop 2 – Done 3 – Busy 4 – Wrong Parameter 5 – Nothing to Stop 6 – Start 7 – Timeout 8 – Error	Send IR command to port: #IR-SND _{1,1,1,1,1,1,1} <CR>
IR-STOP	Send IR stop command to port.	COMMAND #IR-STOP _{ir_index,sn_id,cmd_name} <CR> FEEDBACK ~nn@IR-STOP _{ir_index,sn_id,cmd_name,ir_status} <CR><LF>	ir_index – Number that indicates the specific ir port: 1-N (N= the total number of inputs) * - broadcasts to all ports sn_id – Serial number of command for flow control and response commands from device cmd_name – String: IR command name limited to 15 chars. Controlling device must send the correct name (white space or commas forbidden) ir_status – IR Status 0 – Sent (no error) 1 – Stop 2 – Done 3 – Busy 4 – Wrong Parameter 5 – Nothing to Stop 6 – Start 7 – Timeout 8 – Error	Send IR stop command to IR Port 2: #IR-STOP _{2,1,power} <CR>
LABEL	Set input/output label	COMMAND #LABEL _{io_mode,io_index,switch,label_txt} <CR> FEEDBACK ~nn@LABEL _{io_mode,io_index,switch,label_txt} <CR><LF>	io_mode – Number that indicates the specific input: 0 – Input 1 – Output io_index – Number that indicates the specific input: For inputs – 1 – USB-C IN 1 2 – HDMI IN 2 3 – HDMI IN 3 For output 1 – HDMI output switch – 0 label_txt – Custom label string between 1 and 32 (at least one character and not bigger than 32).	Set the HDMI input label on: #LABEL _{0,2,0,hdmi} <CR>
LABEL?	Get input/output label	COMMAND #LABEL? _{io_mode,io_index,switch,label_txt} <CR> FEEDBACK ~nn@LABEL _{io_mode,io_index,switch,label_txt} <CR><LF>	io_mode – Number that indicates the specific input: 0 – Input 1 – Output io_index – Number that indicates the specific input: For inputs – 1 – USB-C IN 1 2 – HDMI IN 2 3 – HDMI IN 3 For output 1 – HDMI output switch – 0 label_txt – Custom label string between 1 and 32 (at least one character and not bigger than 32). label string	Get the HDMI input label: #LABEL? _{0,2,0,hdmi} <CR>
LOCK-EDID	Lock last read EDID.	COMMAND #LOCK-EDID _{in_index,lock_mode} <CR> FEEDBACK ~nn@LOCK-EDID _{in_index,lock_mode} <CR><LF>	in_index – Number that indicates the specific input: 1 – USB-C IN 2 – HDMI IN lock_mode – On/Off 0 – Off unlocks EDID 1 – On locks EDID	Lock the last read EDID from input 2: #LOCK-EDID _{2,1} <CR>

Function	Description	Syntax	Parameters/Attributes	Example
LOCK-EDID?	Get EDID Lock status.	COMMAND #LOCK-EDID?_in_index <CR> FEEDBACK ~nn@LOCK-EDID,in_index,lock_mode<CR><LF>	in_index – Number that indicates the specific input: 1 – USB-C IN 2 – HDMI IN lock_mode – On/Off 0 – Off unlocks EDID 1 – On locks EDID	Get input 2 Lock EDID status: #LOCK-EDID?_2<CR>
LOG-TAIL?	Get the list of the N last events.	COMMAND #LOG-TAIL?_last_event<CR> FEEDBACK ~nn@LOG-TAIL,last_event,ok,<list><CR><LF>	last_event – the number of last events to view <N = 1,2,3...>	Get the protocol permission level to Admin: #LOG-TAIL?_8<CR>
LOGIN	Set protocol permission. ⓘ The permission system works only if security is enabled with the "SECUR" command. LOGIN allows the user to run commands with an End User or Administrator permission level. When the permission system is enabled, LOGIN enables running commands with the User or Administrator permission level. When set, login must be performed upon each connection. It is not mandatory to enable the permission system in order to use the device. In each device, some connections allow logging in to different levels. Some do not work with security at all. Connection may logout after timeout.	COMMAND #LOGIN_login_level,password<CR> FEEDBACK ~nn@LOGIN_login_level,password_ok<CR><LF> or ~nn@LOGIN_err_004<CR><LF> (if bad password entered)	login_level – Level of permissions required (User or Admin) password – Predefined password (by PASS command). Default password is an empty string	Set the protocol permission level to Admin (when the password defined in the PASS command is 33333): #LOGIN_admin,33333<CR>>
LOGIN?	Get protocol permission state. ⓘ The permission system works only if security is enabled with the "SECUR" command. LOGIN allows the user to run commands with an End User or Administrator permission level. When the permission system is enabled, LOGIN enables running commands with the User or Administrator permission level. When set, login must be performed upon each connection. It is not mandatory to enable the permission system in order to use the device. In each device, some connections allow logging in to different levels. Some do not work with security at all. Connection may logout after timeout.	COMMAND #LOGIN_login_level <CR> FEEDBACK ~nn@LOGIN_login_level,password_ok<CR><LF> or ~nn@LOGIN_err_004<CR><LF> (if bad password entered)	login_level – Level of permissions required (User or Admin) password – Predefined password (by PASS command). Default password is an empty string or NO SECURE if authentication is removed.	Get the protocol permission level to Admin: #LOGIN?_admin<CR>
LOGOUT	Cancel current permission level. ⓘ Logs out from End User or Administrator permission levels to Not Secure.	COMMAND #LOGOUT<CR> FEEDBACK ~nn@LOGOUT_ok<CR><LF>		#LOGOUT<CR>
MODEL?	Get device model.	COMMAND #MODEL?_<CR> FEEDBACK ~nn@MODEL_model_name<CR><LF>	model_name – String of up to 19 printable ASCII chars	Get the device model: #MODEL?_<CR>

Function	Description	Syntax	Parameters/Attributes	Example
NAME	<p>Set machine (DNS) name.</p> <p>i The machine name is not the same as the model name. The machine name is used to identify a specific machine or a network in use (with DNS feature on).</p>	<p>COMMAND</p> <pre>#NAME_ machine_name<CR></pre> <p>FEEDBACK</p> <pre>~nn@NAME_ machine_name<CR><LF></pre>	<p>machine_name – String of up to 15 alpha-numeric chars (can include hyphen, not at the beginning or end)</p>	<p>Set the DNS name of the device to room-442:</p> <pre>#NAME_ room-442<CR></pre>
NAME?	<p>Get machine (DNS) name.</p> <p>i The machine name is not the same as the model name. The machine name is used to identify a specific machine or a network in use (with DNS feature on).</p>	<p>COMMAND</p> <pre>#NAME?_<CR></pre> <p>FEEDBACK</p> <pre>~nn@NAME_ machine_name<CR><LF></pre>	<p>machine_name – String of up to 15 alpha-numeric chars (can include hyphen, not at the beginning or end)</p>	<p>Get the DNS name of the device:</p> <pre>#NAME?_<CR></pre>
NAME-RST	<p>Reset machine (DNS) name to factory default.</p> <p>i Factory default of machine (DNS) name is "KRAMER_" + 4 last digits of device serial number.</p>	<p>COMMAND</p> <pre>#NAME-RST<CR></pre> <p>FEEDBACK</p> <pre>~nn@NAME-RST_ok<CR><LF></pre>		<p>Reset the machine name (S/N last digits are 0102):</p> <pre>#NAME-RST_ kramer_0102<CR></pre>
NET-CONFIG	<p>Set a network configuration.</p> <p>i Parameters [DNS1] and [DNS2] are optional.</p> <p>i For Backward compatibility, the id parameter can be omitted. In this case, the Network ID, by default, is 0, which is the Ethernet control port.</p> <p>i If the gateway address is not compliant to the subnet mask used for the host IP, the command will return an error. Subnet and gateway compliancy specified by RFC950.</p>	<p>COMMAND</p> <pre>#NET-CONFIG_ netw_id,net_ip,net_mask,gateway,[dns1],[dns2]<CR></pre> <p>FEEDBACK</p> <pre>~nn@NET-CONFIG_ netw_id,net_ip,net_mask,gateway<CR><LF></pre>	<p>netw_id – 0</p> <p>net_ip – Network IP</p> <p>net_mask – Network mask</p> <p>gateway – Network gateway</p>	<p>Set the device network parameters to IP address 192.168.113.10, net mask 255.255.0.0, and gateway 192.168.0.1:</p> <pre>#NET-CONFIG_0,192.168.113.10,255.255.0.0,192.168.0.1<CR></pre>
NET-CONFIG?	<p>Get a network configuration.</p> <p>i Parameters [DNS1] and [DNS2] are optional.</p> <p>i For Backward compatibility, the id parameter can be omitted. In this case, the Network ID, by default, is 0, which is the Ethernet control port.</p> <p>i If the gateway address is not compliant to the subnet mask used for the host IP, the command will return an error. Subnet and gateway compliancy specified by RFC950.</p>	<p>COMMAND</p> <pre>#NET-CONFIG_ netw_id,net_ip,net_mask,gateway,[dns1],[dns2]<CR></pre> <p>FEEDBACK</p> <pre>~nn@NET-CONFIG_ netw_id,net_ip,net_mask,gateway<CR><LF></pre>	<p>netw_id – 0</p> <p>net_ip – Network IP</p> <p>net_mask – Network mask</p> <p>gateway – Network gateway</p>	<p>Get the device network parameters:</p> <pre>#NET-CONFIG?_0<CR></pre>
NET-DHCP?	<p>Get DHCP mode.</p> <p>i For Backward compatibility, the id parameter can be omitted. In this case, the Network ID, by default, is 0, which is the Ethernet control port.</p>	<p>COMMAND</p> <pre>#NET-DHCP?_ netw_id<CR></pre> <p>FEEDBACK</p> <pre>~nn@NET-DHCP_ netw_id,dhcp_state<CR><LF></pre>	<p>netw_id – Network ID—the device network interface (if there are more than one). Counting is 0 based, meaning the control port is '0', additional ports are 1,2,3....</p> <p>dhcp_state –</p> <p>0 – Do not use DHCP. Use the IP set by the factory or using the net-ip or net-config command.</p> <p>1 – Try to use DHCP. If unavailable, use the IP set by the factory or using the net-ip or net-config command.</p>	<p>Get DHCP mode for port 1:</p> <pre>#NET-DHCP?_1<CR></pre>

Function	Description	Syntax	Parameters/Attributes	Example
NET-GATE	Set gateway IP. ⓘ A network gateway connects the device via another network and maybe over the Internet. Be careful of security issues. For proper settings consult your network administrator.	COMMAND #NET-GATE_ <u>ip_address</u> <CR> FEEDBACK ~nn@NET-GATE_ <u>ip_address</u> <CR><LF>	<u>ip_address</u> – Format: xxx.xxx.xxx.xxx	Set the gateway IP address to 192.168.0.1: #NET-GATE_ <u>192.168.000.001</u> <CR>
NET-GATE?	Get gateway IP. ⓘ A network gateway connects the device via another network and maybe over the Internet. Be aware of security problems.	COMMAND #NET-GATE?_ <u><CR></u> FEEDBACK ~nn@NET-GATE_ <u>ip_address</u> <CR><LF>	<u>ip_address</u> – Format: xxx.xxx.xxx.xxx	Get the gateway IP address: #NET-GATE?_ <u><CR></u>
NET-IP	Set IP address. ⓘ For proper settings consult your network administrator.	COMMAND #NET-IP_ <u>ip_address</u> <CR> FEEDBACK ~nn@NET-IP_ <u>ip_address</u> <CR><LF>	<u>ip_address</u> – Format: xxx.xxx.xxx.xxx	Set the IP address to 192.168.1.39: #NET-IP_ <u>192.168.001.039</u> <CR>
NET-IP?	Get IP address.	COMMAND #NET-IP?_ <u><CR></u> FEEDBACK ~nn@NET-IP_ <u>ip_address</u> <CR><LF>	<u>ip_address</u> – Format: xxx.xxx.xxx.xxx	Get the IP address: #NET-IP?_ <u><CR></u>
NET-MAC?	Get MAC address. ⓘ For backward compatibility, the <u>id</u> parameter can be omitted. In this case, the Network ID, by default, is 0, which is the Ethernet control port.	COMMAND #NET-MAC?_ <u>id</u> <CR> FEEDBACK ~nn@NET-MAC_ <u>id,mac_address</u> <CR><LF>	<u>id</u> – Network ID—the device network interface (if there are more than one). Counting is 0 based, meaning the control port is '0', additional ports are 1,2,3... <u>mac_address</u> – Unique MAC address. Format: XX-XX-XX-XX-XX-XX where X is hex digit	#NET-MAC?_ <u>id</u> <CR>
NET-MASK	Set subnet mask. ⓘ For proper settings consult your network administrator.	COMMAND #NET-MASK_ <u>net_mask</u> <CR> FEEDBACK ~nn@NET-MASK_ <u>net_mask</u> <CR><LF>	<u>net_mask</u> – Format: xxx.xxx.xxx.xxx	Set the subnet mask to 255.255.0.0: #NET-MASK_ <u>255.255.000.000</u> <CR>
NET-MASK?	Get subnet mask.	COMMAND #NET-MASK?_ <u><CR></u> FEEDBACK ~nn@NET-MASK_ <u>net_mask</u> <CR><LF>	<u>net_mask</u> – Format: xxx.xxx.xxx.xxx	Get the subnet mask: #NET-MASK?_ <u><CR></u>
PASS	Set password for login level. ⓘ The default password is an empty string.	COMMAND #PASS_ <u>login_level,password</u> <CR> FEEDBACK ~nn@PASS_ <u>login_level,password</u> <CR><LF>	<u>login_level</u> – Level of login to set (End User or Administrator). <u>password</u> – Password for the <u>login_level</u> . Up to 15 printable ASCII chars	Set the password for the Admin protocol permission level to 33333: #PASS_ <u>admin,33333</u> <CR>
PASS?	Get password for login level. ⓘ The default password is an empty string.	COMMAND #PASS_ <u>login_level</u> <CR> FEEDBACK ~nn@PASS_ <u>login_level,password</u> <CR><LF>	<u>login_level</u> – Level of login to set (End User or Administrator). <u>password</u> – Password for the <u>login_level</u> . Up to 15 printable ASCII chars	Get the password for the Admin protocol permission: #PASS?_ <u>admin</u> <CR>
PORTS-LIST?	Get the port list of this machine. ⓘ The response is returned in one line and terminated with<CR><LF>. The response format lists port IDs separated by commas. This is an Extended Protocol 3000 command.	COMMAND #PORTS-LIST?_ <u><CR></u> FEEDBACK ~nn@PORTS-LIST_ <u>[<direction_type>.<port_format>.<port_index>,.,.]<CR><LF></u>	The following attributes comprise the port ID: ▪ <u><direction_type></u> – Direction of the port: ○ IN ○ OUT ▪ <u><port_format></u> – Type of signal on the port: ○ HDMI ○ USB_C ▪ <u><port_index></u> – The port number as printed on the front or rear panel	Get the ports list: #PORTS-LIST?_ <u><CR></u>
PRG-ACTION	Add new user command. ⓘ Programs matrix action as a response for external event (programmable button pressed).	COMMAND #PRG-ACTION_ <u>commandNum,type,name,command</u> <CR> FEEDBACK ~nn@PRG-ACTION_ <u>commandNum,type,name,command</u> <CR><LF>	<u>commandNum</u> – Command number 0 to 4 <u>type</u> – External programmable button 0 – CEC 1 – UART 2 – IR <u>name</u> – Bitmap representing <u>command</u> – External programmable button ID	Add a new user command: #PRG-ACTION_ <u>1,3,1,0</u> <CR>
PRG-ACTION?	Add new user command. ⓘ Programs matrix action as a response for external event (programmable button pressed).	COMMAND #PRG-ACTION?_ <u>commandNum</u> <CR> FEEDBACK ~nn@PRG-ACTION_ <u>commandNum,type,name,command</u> <CR><LF>	<u>commandNum</u> – Command number 0 – Input 1 – Output <u>type</u> – External programmable button ID <u>name</u> – Bitmap representing <u>command</u> – External programmable button ID	Add a new user command: #PRG-ACTION?_ <u>0,3,1,0</u> <CR>

Function	Description	Syntax	Parameters/Attributes	Example
PRG-BTN-ACTION	Set device's programmable button, link to commands On & Off, and set command to momentary or not momentary.	COMMAND #PRG-BTN- MOD_ btnNum,mode,actionOn,actionOff,btnBehavior<CR> FEEDBACK ~nn@PRG-BTN- MOD_ btnNum,mode,actionOn,actionOff,btnBehavior<CR><LF> >	btnNum – Button number 0 to 4 1 and 2 are enabled when remote button is (mode) On 1 – IO 1 button 2 – IO 2 button 3 – Display On button mode – Remote button state 0 – Off 1 – On actionOn – 100 – None 101 – Switch Input 102 – Display On (via CEC) 103 – Display Off (via CEC) 104 – Mute 105 – Unmute 106 – Volume ++ 107 – Volume -- 0 – Command_01 1 – Command_02 2 – Command_03 3 – Command_04 4 – Custom 5 actionOff – Button_mode 100 – None 101 – Switch Input 102 – Display On (via CEC) 103 – Display Off (via CEC) 104 – Mute 105 – Unmute 106 – Volume ++ 107 – Volume -- 0 – Command_01 1 – Command_02 2 – Command_03 3 – Command_04 4 – Custom 5 btnBehavior – Button_mode 0 – Momentary mode disabled 1 – Momentary mode enabled	Set the DISPLAY ON button to mute/unmute with the press of a button: #PRG-BTN- MOD_3,1,104,105,0<CR>
PRG-BTN-MOD?	Get device's programmable button, link to commands On & Off, and set command to momentary or not momentary.	COMMAND #PRG-BTN-MOD? <CR> FEEDBACK ~nn@PRG-BTN-MOD_ button_mode<CR><LF>	btnNum – Button number 0 to 4 1 and 2 are enabled when remote button is (mode) On 1 – IO 1 button 2 – IO 2 button 3 – Display On button mode – Remote button state 0 – Off 1 – On actionOn – 100 – None 101 – Switch Input 102 – Display On (via CEC) 103 – Display Off (via CEC) 104 – Mute 105 – Unmute 106 – Volume ++ 107 – Volume -- 0 – Command_01 1 – Command_02 2 – Command_03 3 – Command_04 4 – Custom 5 actionOff – Button_mode 100 – None 101 – Switch Input 102 – Display On (via CEC) 103 – Display Off (via CEC) 104 – Mute 105 – Unmute 106 – Volume ++ 107 – Volume -- 0 – Command_01 1 – Command_02 2 – Command_03 3 – Command_04 4 – Custom 5 btnBehavior – Button_mode 0 – Momentary mode disabled 1 – Momentary mode enabled	Get the mode of button 3: #PRG-BTN-MOD?_3<CR>
PRIORITY	Set input priority.	COMMAND #PRIORITY_ layer_type,priority_1,priority_2,priority_3<CR> FEEDBACK ~nn@PRIORITY_ layer_type,priority_1,priority_2,priority_3<CR><LF>	layer_type – Layer Enumeration 1 – Video priority – Priority of inputs (1-2) 1 – USB-C 1 2 – HDMI 2 3 – HDMI 3	Set the priority to first HDMI 2, USB-C 1 second and HDMI 3 third: #PRIORITY_1,2,1,3<CR>

Function	Description	Syntax	Parameters/Attributes	Example
PRIORITY?	Set input priority.	COMMAND #PRIORITY?_layer_type<CR> FEEDBACK ~nn@PRIORITY_layer_type,priority_1,priority_2,priority_3<CR><LF>	layer_type – Layer Enumeration 1 – Video priority – Priority of inputs (1-2) 1 – USB-C 1 2 – HDMI 2 3 – HDMI 3	Get the input priority: #PRIORITY?_1<CR>
PROT-VER?	Get device protocol version.	COMMAND #PROT-VER?_<CR> FEEDBACK ~nn@PROT-VER_3000:version<CR><LF>	version – XX.XX where X is a decimal digit	Get the device protocol version: #PROT-VER?_<CR>
RESET	Reset device. i To avoid locking the port due to a USB bug in Windows, disconnect USB connections immediately after running this command. If the port was locked, disconnect, and reconnect the cable to reopen the port.	COMMAND #RESET<CR> FEEDBACK ~nn@RESET_ok<CR><LF>		Reset the device: #RESET<CR>
ROUTE	Set layer routing. i This command replaces all other routing commands.	COMMAND #ROUTE_layer_type,out_index,in_index<CR> FEEDBACK ~nn@ROUTE_layer_type,out_index,in_index<CR><LF>	layer_type Layer Enumeration 1 – Video 5 – USB out_index 1 – Output in_index – Source id for Video: 1 – USB-C 1 2 – HDMI IN 2 3 – HDMI IN 3	Route video input 2 to the output: #ROUTE_1,1,2<CR>
ROUTE?	Get layer routing state. i This command replaces all other routing commands.	COMMAND #ROUTE?_layer_type,out_index<CR> FEEDBACK ~nn@ROUTE_layer_type,out_index,in_index <CR><LF>	layer_type Layer Enumeration 1 – Video 5 – USB out_index 1 – Output in_index – Source id for Video: 1 – USB-C 1 2 – HDMI IN 2 3 – HDMI IN 3	Get video routing output: #ROUTE?_1,1<CR>
SECUR	Start/stop security. i The permission system works only if security is enabled with the "SECUR" command.	COMMAND #SECUR_security_state<CR> FEEDBACK ~nn@SECUR_security_state<CR><LF>	security_state – Security state 0 – OFF (disables security) 1 – ON (enables security)	Enable the permission system: #SECUR_1<CR>
SECUR?	Get security state. i The permission system works only if security is enabled with the "SECUR" command.	COMMAND #SECUR?_security_state<CR> FEEDBACK ~nn@SECUR_security_state<CR><LF>	security_state – Security state 0 – OFF (disables security) 1 – ON (enables security)	Enable the permission system: #SECUR?_<CR>
SIGNAL?	Get input signal status.	COMMAND #SIGNAL?_in_index<CR> FEEDBACK ~nn@SIGNAL_in_index,status<CR><LF>	in_index – Number that indicates the specific input: 1 – USB-C IN 1 2 – HDMI IN 2 3 – HDMI IN 3 status – Signal status according to signal validation: 0 – Off 1 – On	Get the input signal lock status of IN 1: #SIGNAL?_1<CR>
SN?	Get device serial number.	COMMAND #SN?_<CR> FEEDBACK ~nn@SN_serial_num<CR><LF>	serial_num – 14 decimal digits, factory assigned	Get the device serial number: #SN?_<CR>
TIME	Set device time and date. i The year must be 4 digits. The device does not validate the day of week from the date. Time format - 24 hours. Date format - Day, Month, Year.	COMMAND #TIME_day_of_week,date,data<CR> FEEDBACK ~nn@TIME_day_of_week,date,data<CR><LF>	day_of_week – One of (SUN,MON,TUE,WED,THU,FRI,SAT) date – Format: DD-MM-YYYY. data – Format: hh:mm:ss where hh = hours mm = minutes ss = seconds	Set device time and date to December 5, 2020 at 2:30pm: #TIME_mon_05-12-2020,14:30:00<CR>

Function	Description	Syntax	Parameters/Attributes	Example
TIME?	<p>Get device time and date.</p> <p>i The year must be 4 digits.</p> <p>The device does not validate the day of week from the date.</p> <p>Time format - 24 hours.</p> <p>Date format - Day, Month, Year.</p>	<p>COMMAND</p> <pre>#TIME?_<CR></pre> <p>FEEDBACK</p> <pre>~nn@TIME,_day_of_week,date,data<CR><LF></pre>	<p>day_of_week – One of {SUN,MON,TUE,WED,THU,FRI,SAT}</p> <p>date – Format: YYYY/MM/DD where YYYY = Year MM = Month DD = Day</p> <p>data – Format: hh:mm:ss where hh = hours mm = minutes ss = seconds</p>	<p>Get device time and date: #TIME?<CR></p>
TIME-LOC	<p>Set local time offset from UTC/GMT.</p> <p>i If the time server is configured, device time calculates by adding UTC_off to UTC time (that it got from the time server) + 1 hour if daylight savings time is in effect.</p> <p>TIME command sets the device time without considering these settings.</p>	<p>COMMAND</p> <pre>#TIME-LOC,_utc_off,dst_state<CR></pre> <p>FEEDBACK</p> <pre>~nn@TIME-LOC,_utc_off,dst_state<CR><LF></pre>	<p>utc_off – Offset of device time from UTC/GMT (without daylight time correction)</p> <p>dst_state – Daylight saving time state 0 – no daylight saving time 1 – daylight saving time</p>	<p>Set local time offset to 3 with no daylight-saving time: #TIME-LOC_3,0<CR></p>
TIME-LOC?	<p>Get local time offset from UTC/GMT.</p> <p>i If the time server is configured, device time calculates by adding UTC_off to UTC time (that it got from the time server) + 1 hour if daylight savings time is in effect.</p> <p>TIME command sets the device time without considering these settings.</p>	<p>COMMAND</p> <pre>#TIME-LOC?_<CR></pre> <p>FEEDBACK</p> <pre>~nn@TIME-LOC,_utc_off,dst_state<CR><LF></pre>	<p>utc_off – Offset of device time from UTC/GMT (without daylight time correction)</p> <p>dst_state – Daylight saving time state 0 – no daylight saving time 1 – daylight saving time</p>	<p>Get local time offset from UTC/GMT: #TIME-LOC?<CR></p>
TIME-SRV	<p>Set time server.</p> <p>i This command is needed for setting UDP timeout for the current client list.</p>	<p>COMMAND</p> <pre>#TIME-SRV,_mode,time_server_ip,sync_hour<CR></pre> <p>FEEDBACK</p> <pre>~nn@TIME-SRV,_mode,time_server_ip,sync_hour,server_status<CR><LF></pre>	<p>mode – On/Off 0 – Off 1 – On</p> <p>time_server_ip – Time server IP address</p> <p>sync_hour – Hour in day for time server sync</p> <p>server_status – On/Off</p>	<p>Set time server with IP address of 128.138.140.44 to ON: #TIME-SRV_1,128.138.140.44,0,1<CR></p>
TIME-SRV?	<p>Get time server.</p> <p>i This command is needed for setting UDP timeout for the current client list.</p>	<p>COMMAND</p> <pre>#TIME-SRV?_<CR></pre> <p>FEEDBACK</p> <pre>~nn@TIME-SRV,_mode,time_server_ip,sync_hour,server_status<CR><LF></pre>	<p>mode – On/Off 0 – Off 1 – On</p> <p>time_server_ip – Time server IP address</p> <p>sync_hour – Hour in day for time server sync</p> <p>server_status – On/Off</p>	<p>Get time server: #TIME-SRV?<CR></p>
UART	<p>Set com port configuration.</p> <p>i In the FC-2x the serial port is selectable to RS-232 or RS-485 (usually serial port 1).</p> <p>If Serial is configured when RS-485 is selected, the RS-485 UART port automatically changes.</p> <p>The command is backward compatible, meaning that if the extra parameters do not exist, FW goes to RS-232.</p> <p>Stop_bits 1.5 is only relevant for 5 data_bits.</p>	<p>COMMAND</p> <pre>#UART,_com_id,baud_rate,data_bits,parity,stop_bits_mode,serial_type,485_term<CR></pre> <p>FEEDBACK</p> <pre>~nn@UART,_com_id,baud_rate,data_bits,parity,stop_bits_mode,serial_type,485_term<CR><LF></pre>	<p>com_id – 1 to n (machine dependent)</p> <p>baud_rate – 9600 - 115200</p> <p>data_bits – 5-8</p> <p>parity – Parity Type 0 – No 1 – Odd 2 – Even 3 – Mark 4 – Space</p> <p>stop_bits_mode – 1/1.5/2</p> <p>serial_type – 232/485 0 – 232 1 – 485</p> <p>485_term – 485 termination state 0 – disable 1 – enable (optional - this exists only when serial_type is 485)</p>	<p>Set baud rate to 9600, 8 data bits, parity to none and stop bit to 1: #UART_9600,8,node,1<CR></p>

Function	Description	Syntax	Parameters/Attributes	Example
UART?	Get com port configuration. The command is backward compatible, meaning that if the extra parameters do not exist, FW goes to RS-232. Stop_bits 1.5 is only relevant for 5 data_bits.	COMMAND #UART?_com_id<CR> FEEDBACK ~nn@UART_com_id,baud_rate,data_bits,parity,stop_bits_mode,serial_type,485_term<CR><LF>	com_id – 1 to n (machine dependent) baud_rate – 9600 - 115200 data_bits – 5-8 parity – Parity Type 0 – No 1 – Odd 2 – Even 3 – Mark 4 – Space stop_bits_mode – 1/1.5/2 serial_type – 232/485 0 – 232 1 – 485 485_term – 485 termination state 0 – disable 1 – enable (optional - this exists only when serial_type is 485)	Set baud rate to 9600, 8 data bits, parity to none and stop bit to 1: #UART_1,9600,8,0,1<CR>
USBC-ETH	Set USBC to Ethernet connection.	COMMAND #USBC-ETH_state<CR> FEEDBACK ~nn@USBC-ETH_state<CR><LF>	state – On/Off 0 – Off 1 – On	Set USBC to Ethernet connection state to ON: #USBC-ETH_1<CR>
USB-FV	Set USB auto-switching mode.	COMMAND #USB-FV_mode<CR> FEEDBACK ~nn@USB-FV_mode<CR><LF>	mode – On/Off 0 – Off 1 – On	Set auto-switching mode to ON: #USB-FV_1<CR>
USB-FV?	Get USB auto-switching mode.	COMMAND #USB-FV?_mode<CR> FEEDBACK ~nn@USB-FV_mode<CR><LF>	mode – On/Off 0 – Off 1 – On	Set auto-switching mode to ON: #USB-FV_1<CR>
USBA-DISCONNECT-MODE	Set USB device auto-disconnection mode..	COMMAND #USBA-DISCONNECT-MODE_USBDevice,mode<CR> FEEDBACK ~nn@USBA-DISCONNECT-MODE_mode<CR><LF>	USBDevice – USB device number 1 – USB Device 1 2 – USB Device 2 3 – USB Device 3 4 – USB Device 4 mode – On/Off 0 – Off 1 – On	Set USB Device 1 polycm mode to ON: #USBA-DISCONNECT-MODE_1,1<CR>
USBA-DISCONNECT-MODE?	Get USB device auto-disconnection mode..	COMMAND #USBA-DISCONNECT-MODE?_USBDevice<CR> FEEDBACK ~nn@USBA-DISCONNECT-MODE_mode<CR><LF>	USBDevice – USB device number 1 – USB Device 1 2 – USB Device 2 3 – USB Device 3 4 – USB Device 4 mode – On/Off 0 – Off 1 – On	Get USB Device 1 polycm mode: #USBA-DISCONNECT-MODE?_1<CR>
VERSION?	Get firmware version number.	COMMAND #VERSION?_<CR> FEEDBACK ~nn@VERSION_firmware_version<CR><LF>	firmware_version – XX.XX.XXXX where the digit groups are: major.minor.build version	Get the device firmware version number: #VERSION?_<CR>
VMUTE	Set enable/disable video on output. ❗ Video mute parameter 2 (blank picture) is not supported.	COMMAND #VMUTE_out_index,flag<CR> FEEDBACK ~nn@VMUTE_out_index,flag<CR><LF>	out_index – Number that indicates the specific output – 1 flag – Video Mute 0 – Video enabled 1 – Video disabled 2 – Blank picture	Disable the video output on output: #VMUTE_1,0<CR>
VMUTE?	Get video on output status. ❗ Video mute parameter 2 (blank picture) is not supported.	COMMAND #VMUTE?_out_index<CR> FEEDBACK ~nn@VMUTE_out_index,flag<CR><LF>	out_index – Number that indicates the specific output – 1 flag – Video Mute 0 – Video enabled 1 – Video disabled 2 – Blank picture	Get video on output status: #VMUTE?_1<CR>

Result and Error Codes

Syntax

In case of an error, the device responds with an error message. The error message syntax:

- ~NN@ERR XXX<CR><LF> – when general error, no specific command
- ~NN@CMD ERR XXX<CR><LF> – for specific command
- NN – machine number of device, default = 01

- **XXX** – error code

Error Codes

Error Name	Error Code	Description
P3K_NO_ERROR	0	No error
ERR_PROTOCOL_SYNTAX	1	Protocol syntax
ERR_COMMAND_NOT_AVAILABLE	2	Command not available
ERR_PARAMETER_OUT_OF_RANGE	3	Parameter out of range
ERR_UNAUTHORIZED_ACCESS	4	Unauthorized access
ERR_INTERNAL_FW_ERROR	5	Internal FW error
ERR_BUSY	6	Protocol busy
ERR_WRONG_CRC	7	Wrong CRC
ERR_TIMEDOUT	8	Timeout
ERR_RESERVED	9	(Reserved)
ERR_FW_NOT_ENOUGH_SPACE	10	Not enough space for data (firmware, FPGA...)
ERR_FS_NOT_ENOUGH_SPACE	11	Not enough space – file system
ERR_FS_FILE_NOT_EXISTS	12	File does not exist
ERR_FS_FILE_CANT_CREATED	13	File can't be created
ERR_FS_FILE_CANT_OPEN	14	File can't open
ERR_FEATURE_NOT_SUPPORTED	15	Feature is not supported
ERR_RESERVED_2	16	(Reserved)
ERR_RESERVED_3	17	(Reserved)
ERR_RESERVED_4	18	(Reserved)
ERR_RESERVED_5	19	(Reserved)
ERR_RESERVED_6	20	(Reserved)
ERR_PACKET_CRC	21	Packet CRC error
ERR_PACKET_MISSED	22	Packet number isn't expected (missing packet)
ERR_PACKET_SIZE	23	Packet size is wrong
ERR_RESERVED_7	24	(Reserved)
ERR_RESERVED_8	25	(Reserved)
ERR_RESERVED_9	26	(Reserved)
ERR_RESERVED_10	27	(Reserved)
ERR_RESERVED_11	28	(Reserved)
ERR_RESERVED_12	29	(Reserved)
ERR_EDID_CORRUPTED	30	EDID corrupted
ERR_NON_LISTED	31	Device specific errors
ERR_SAME_CRC	32	File has the same CRC – not changed
ERR_WRONG_MODE	33	Wrong operation mode
ERR_NOT_CONFIGURED	34	Device/chip was not initialized

The warranty obligations of Kramer Electronics Inc. ("Kramer Electronics") for this product are limited to the terms set forth below:

What is Covered

This limited warranty covers defects in materials and workmanship in this product.

What is Not Covered

This limited warranty does not cover any damage, deterioration or malfunction resulting from any alteration, modification, improper or unreasonable use or maintenance, misuse, abuse, accident, neglect, exposure to excess moisture, fire, improper packing and shipping (such claims must be presented to the carrier), lightning, power surges, or other acts of nature. This limited warranty does not cover any damage, deterioration or malfunction resulting from the installation or removal of this product from any installation, any unauthorized tampering with this product, any repairs attempted by anyone unauthorized by Kramer Electronics to make such repairs, or any other cause which does not relate directly to a defect in materials and/or workmanship of this product. This limited warranty does not cover cartons, equipment enclosures, cables or accessories used in conjunction with this product.

Without limiting any other exclusion herein, Kramer Electronics does not warrant that the product covered hereby, including, without limitation, the technology and/or integrated circuit(s) included in the product, will not become obsolete or that such items are or will remain compatible with any other product or technology with which the product may be used.

How Long this Coverage Lasts

The standard limited warranty for Kramer products is seven (7) years from the date of original purchase, with the following exceptions:

1. All Kramer VIA hardware products are covered by a standard three (3) year warranty for the VIA hardware and a standard three (3) year warranty for firmware and software updates; all Kramer VIA accessories, adapters, tags, and dongles are covered by a standard one (1) year warranty.
2. Kramer fiber optic cables, adapter-size fiber optic extenders, pluggable optical modules, active cables, cable retractors, ring mounted adapters, portable power chargers, Kramer speakers, and Kramer touch panels are covered by a standard one (1) year warranty. Kramer 7-inch touch panels purchased on or after April 1st, 2020 are covered by a standard two (2) year warranty.
3. All Kramer Calibre products, all Kramer Minicom digital signage products, all HighSecLabs products, all streaming, and all wireless products are covered by a standard three (3) year warranty.
4. All Sierra Video MultiViewers are covered by a standard five (5) year warranty.
5. Sierra switchers & control panels are covered by a standard seven (7) year warranty (excluding power supplies and fans that are covered for three (3) years).
6. K-Touch software is covered by a standard one (1) year warranty for software updates.
7. All Kramer passive cables are covered by a lifetime warranty.

Who is Covered

Only the original purchaser of this product is covered under this limited warranty. This limited warranty is not transferable to subsequent purchasers or owners of this product.

What Kramer Electronics Will Do

Kramer Electronics will, at its sole option, provide one of the following three remedies to whatever extent it shall deem necessary to satisfy a proper claim under this limited warranty:

1. Elect to repair or facilitate the repair of any defective parts within a reasonable period of time, free of any charge for the necessary parts and labor to complete the repair and restore this product to its proper operating condition. Kramer Electronics will also pay the shipping costs necessary to return this product once the repair is complete.
2. Replace this product with a direct replacement or with a similar product deemed by Kramer Electronics to perform substantially the same function as the original product. If a direct or similar replacement product is supplied, the original product's end warranty date remains unchanged and is transferred to the replacement product.
3. Issue a refund of the original purchase price less depreciation to be determined based on the age of the product at the time remedy is sought under this limited warranty.

What Kramer Electronics Will Not Do Under This Limited Warranty

If this product is returned to Kramer Electronics or the authorized dealer from which it was purchased or any other party authorized to repair Kramer Electronics products, this product must be insured during shipment, with the insurance and shipping charges prepaid by you. If this product is returned uninsured, you assume all risks of loss or damage during shipment. Kramer Electronics will not be responsible for any costs related to the removal or re-installation of this product from or into any installation. Kramer Electronics will not be responsible for any costs related to any setting up this product, any adjustment of user controls or any programming required for a specific installation of this product.

How to Obtain a Remedy Under This Limited Warranty

To obtain a remedy under this limited warranty, you must contact either the authorized Kramer Electronics reseller from whom you purchased this product or the Kramer Electronics office nearest you. For a list of authorized Kramer Electronics resellers and/or Kramer Electronics authorized service providers, visit our web site at www.kramerav.com or contact the Kramer Electronics office nearest you.

In order to pursue any remedy under this limited warranty, you must possess an original, dated receipt as proof of purchase from an authorized Kramer Electronics reseller. If this product is returned under this limited warranty, a return authorization number, obtained from Kramer Electronics, will be required (RMA number). You may also be directed to an authorized reseller or a person authorized by Kramer Electronics to repair the product.

If it is decided that this product should be returned directly to Kramer Electronics, this product should be properly packed, preferably in the original carton, for shipping. Cartons not bearing a return authorization number will be refused.

Limitation of Liability

THE MAXIMUM LIABILITY OF KRAMER ELECTRONICS UNDER THIS LIMITED WARRANTY SHALL NOT EXCEED THE ACTUAL PURCHASE PRICE PAID FOR THE PRODUCT. TO THE MAXIMUM EXTENT PERMITTED BY LAW, KRAMER ELECTRONICS IS NOT RESPONSIBLE FOR DIRECT, SPECIAL, INCIDENTAL OR CONSEQUENTIAL DAMAGES RESULTING FROM ANY BREACH OF WARRANTY OR CONDITION, OR UNDER ANY OTHER LEGAL THEORY. Some countries, districts or states do not allow the exclusion or limitation of relief, special, incidental, consequential or indirect damages, or the limitation of liability to specified amounts, so the above limitations or exclusions may not apply to you.

Exclusive Remedy

TO THE MAXIMUM EXTENT PERMITTED BY LAW, THIS LIMITED WARRANTY AND THE REMEDIES SET FORTH ABOVE ARE EXCLUSIVE AND IN LIEU OF ALL OTHER WARRANTIES, REMEDIES AND CONDITIONS, WHETHER ORAL OR WRITTEN, EXPRESS OR IMPLIED. TO THE MAXIMUM EXTENT PERMITTED BY LAW, KRAMER ELECTRONICS SPECIFICALLY DISCLAIMS ANY AND ALL IMPLIED WARRANTIES, INCLUDING, WITHOUT LIMITATION, WARRANTIES OF MERCHANTABILITY AND FITNESS FOR A PARTICULAR PURPOSE. IF KRAMER ELECTRONICS CANNOT LAWFULLY DISCLAIM OR EXCLUDE IMPLIED WARRANTIES UNDER APPLICABLE LAW, THEN ALL IMPLIED WARRANTIES COVERING THIS PRODUCT, INCLUDING WARRANTIES OF MERCHANTABILITY AND FITNESS FOR A PARTICULAR PURPOSE, SHALL APPLY TO THIS PRODUCT AS PROVIDED UNDER APPLICABLE LAW. IF ANY PRODUCT TO WHICH THIS LIMITED WARRANTY APPLIES IS A "CONSUMER PRODUCT" UNDER THE MAGNUSON-MOSS WARRANTY ACT (15 U.S.C.A. §2301, ET SEQ.) OR OTHER APPLICABLE LAW, THE FOREGOING DISCLAIMER OF IMPLIED WARRANTIES SHALL NOT APPLY TO YOU, AND ALL IMPLIED WARRANTIES ON THIS PRODUCT, INCLUDING WARRANTIES OF MERCHANTABILITY AND FITNESS FOR THE PARTICULAR PURPOSE, SHALL APPLY AS PROVIDED UNDER APPLICABLE LAW.

Other Conditions

This limited warranty gives you specific legal rights, and you may have other rights which vary from country to country or state to state.

This limited warranty is void if (i) the label bearing the serial number of this product has been removed or defaced, (ii) the product is not distributed by Kramer Electronics or (iii) this product is not purchased from an authorized Kramer Electronics reseller. If you are unsure whether a reseller is an authorized Kramer Electronics reseller, visit our web site at www.kramerav.com or contact a Kramer Electronics office from the list at the end of this document.

Your rights under this limited warranty are not diminished if you do not complete and return the product registration form or complete and submit the online product registration form. Kramer Electronics thanks you for purchasing a Kramer Electronics product. We hope it will give you years of satisfaction.



HDMI™
HIGH-DEFINITION MULTIMEDIA INTERFACE



P/N:



2900-301609

Rev:

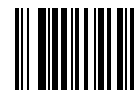

9



SAFETY WARNING

Disconnect the unit from the power supply before opening and servicing

For the latest information on our products and a list of Kramer distributors, visit our website where updates to this user manual may be found.

We welcome your questions, comments, and feedback.

The terms HDMI, HDMI High-Definition Multimedia Interface, and the HDMI Logo are trademarks or registered trademarks of HDMI Licensing Administrator, Inc. All brand names, product names, and trademarks are the property of their respective owners.