



# USER MANUAL

## MODELS:

SWT3-41-U-T, EXT3-UE-R, EXT3-U-R,  
ACC3-12-SP

4x1 USB Switcher Transmitter, USB  
Receivers, 1:2 CAT Cable Splitter



# Contents

<b>Introduction</b>	<b>1</b>
Getting Started	1
Overview	2
Typical Applications	5
<b>Defining SWT3-41-U-T 4x1 USB Switcher</b>	<b>6</b>
Defining SWT3-41-U-T	6
Defining EXT3-UE-R	8
Defining EXT3-U-R	9
Defining ACC3-12-SP	10
<b>Mounting SWT3-41-U-T, EXT3-UE-R, EXT3-U-R, and ACC3-12-SP</b>	<b>11</b>
Mounting SWT3-41-U-T	11
Mounting EXT3-UE-R	12
Mounting EXT3-U-R	13
Mounting ACC3-12-SP	14
<b>Connecting SWT3-41-U-T</b>	<b>15</b>
Connecting the Output to a Balanced/Unbalanced Stereo Audio Acceptor	17
Connecting a Balanced/Unbalanced Stereo Audio Source to the Balanced Input	17
Connecting to Devices via RS-232	18
<b>Operating and Controlling SWT3-41-U-T</b>	<b>19</b>
Principles of Operation	19
Using Front Panel Buttons	22
Operating via Ethernet	22
<b>Using Embedded Web Pages</b>	<b>26</b>
Operation	29
Settings	30
Diagnostics	50
Administration	50
Viewing the About Page	56
<b>Upgrading Firmware</b>	<b>57</b>
<b>Technical Specifications</b>	<b>58</b>
SWT3-41-U-T	58
EXT3-UE-R	59
EXT3-U-R	61
ACC3-12-SP	62
Default Communication Parameters	63
<b>Protocol 3000</b>	<b>64</b>
Understanding Protocol 3000	64
Protocol 3000 Commands	65
Result and Error Codes	75

# Introduction

Welcome to Kramer Electronics! Since 1981, Kramer Electronics has been providing a world of unique, creative, and affordable solutions to the vast range of problems that confront the video, audio, presentation, and broadcasting professional on a daily basis. In recent years, we have redesigned and upgraded most of our line, making the best even better!

---

## Getting Started

We recommend that you:

- Unpack the equipment carefully and save the original box and packaging materials for possible future shipment.
- Review the contents of this user manual.



Go to [www.kramerav.com/downloads/SWT3-41-U-T](http://www.kramerav.com/downloads/SWT3-41-U-T) to check for up-to-date user manuals, application programs, and to check if firmware upgrades are available (where appropriate).

## Achieving Best Performance

- Use only good quality connection cables (we recommend Kramer high-performance, high-resolution cables) to avoid interference, deterioration in signal quality due to poor matching, and elevated noise levels (often associated with low quality cables).
- Do not secure the cables in tight bundles or roll the slack into tight coils.
- Avoid interference from neighboring electrical appliances that may adversely influence signal quality.
- Position your Kramer **SWT3-41-U-T** away from moisture, excessive sunlight and dust.

## Safety Instructions



### Caution:

- This equipment is to be used only inside a building. It may only be connected to other equipment that is installed inside a building.
- For products with relay terminals and GPIO ports, please refer to the permitted rating for an external connection, located next to the terminal or in the User Manual.
- There are no operator serviceable parts inside the unit.



### Warning:

- Use only the power cord that is supplied with the unit.
- To ensure continuous risk protection, replace fuses only according to the rating specified on the product label which is located on the bottom of the unit.

## Recycling Kramer Products

The Waste Electrical and Electronic Equipment (WEEE) Directive 2002/96/EC aims to reduce the amount of WEEE sent for disposal to landfill or incineration by requiring it to be collected

and recycled. To comply with the WEEE Directive, Kramer Electronics has made arrangements with the European Advanced Recycling Network (EARN) and will cover any costs of treatment, recycling and recovery of waste Kramer Electronics branded equipment on arrival at the EARN facility. For details of Kramer's recycling arrangements in your particular country go to our recycling pages at [www.kramerav.com/social-responsibility/environment](http://www.kramerav.com/social-responsibility/environment).

---

## Overview

Congratulations on purchasing your Kramer **SWT3-41-U-T/ EXT3-UE-R/ EXT3-U-R/ ACC3-12-SP**.

This section defines **SWT3-41-U-T, EXT3-UE-R, EXT3-U-R and ACC3-12-SP**.

### SWT3-41-U-T 4x1 USB Switcher

The **SWT3-41-U-T** is a high-performance switcher transmitter with two USB-C and two USB-B ports for USB host devices connection and plug and play host user auto-switching experience based on active USB signal detection. The local and remote (over CAT-links) connected USB peripherals, such as a room camera and microphone, are switchable for use of the active USB host, for convenient online meeting participants operation.

**SWT3-41-U-T** provides exceptional quality, advanced and user-friendly operation, and flexible control.

#### Exceptional Quality

- **USB 3.2 Switching** — USB 3.2 signals switching, enables high data-rate connection between active USB host and meeting space USB 3.2 and 2.0 devices, such as 4K camera, high-quality audio devices, and HID (Human Interface Devices) mouse or keyboard devices.
- **Comprehensive USB Extension** – Integrated dual-link transmitters for USB and LAN signals extension with 2-way power providing over extended-reach CAT twisted pair copper infrastructures. The locally selected USB host is auto-connected to remotely connected USB devices, employing either interrupt, bulk or isochronous USB 2.0 standard data transfer communication
- **Cost-effective Dual-link USB Extension Deployment** – Link-paired remote USB receivers are flexibly connected via combined dual-link single CAT cable or dual independent CAT cables connections, according to space extension deployment needs. Typically used for long-distance connection of space remote two PTZ cameras, the combined dual-link single CAT cable runs to a midspan-located CAT splitter that optimally connects to receiver-connected cameras via the shortest independent CAT cables.

#### Advanced and User-friendly Operation

- **Collaborative Online-meeting Switching** – Controllable switching of online-session USB host participants and space-deployed local and remote visual (such as camera) and audible (such as microphones or headsets) USB peripherals, allows collaborative online meeting and smooth content sharing operation among online meeting participants.
- **BYOD Ease and Convenience** — Connect any USB-C device as an online meeting

participant, while providing the connected device with multiple concurrent capabilities of USB 3.2 and Ethernet connection, USB-driven content sharing, and (if PD-2.0-capable) up to 60 watts of power, all via a single USB-C cable connection only.

- **Auto Switcher Ease of Use** — Automatically connects the plugged host to the space connected USB peripherals, according to user-configured preferences, such as last-connected host.
- **Simple and Flexible Control** – Remote IP-controller connection, browser operation webpage, local panel buttons, and remotely connected contact-closure buttons triggering configurable operation functions, for easy and fully flexible USB host ports selection, and switcher control.

### Flexible Connectivity

- **Flexible USB Connectivity** – Wide Variety of USB peripheral and dual-role devices can be extended including cameras, touch screens, smart boards, hard drives, game controllers, audio devices, printers, scanners, or HID (Human Interface Devices) devices such as a mouse or keyboard.
- **Built-in Intelligent Control Gateway** – Remote IP-driven intelligent control of local and remote connected USB peripherals (such as PTZ cameras) and sensor devices via IP, RS-232 or I/O. Eliminating the need for an external control gateway, this feature reduces installation complexity and costs, to enable easy integration with control systems, such as Kramer Control.
- **Secured Connectivity** — Standard IT-grade 802.1x authentication for secured IT LAN connectivity operation.
- **Comprehensive and Cost-effective Management** — Local panel indication LEDs to facilitate easy local maintenance and troubleshooting. Remote IP-driven device firmware upgrade and management, via user-friendly embedded web pages and optional whole site management system, ensure lasting and field proven deployment.
- **Easy and Elegant Installation** — PoE powering via LAN port connection, 2-way powering to CAT-paired devices, and half 19" rack noise-free fan-cooled enclosure for under table mounting, or side-by-side mounting of 2 units in a 1U rack space, for easy and convenient deployment.

## EXT3-UE-R USB Receiver

**EXT3-UE-R** is a comprehensive 2-way powering USB 2.0 receiver over extended-reach twisted pair CAT cable. The receiver converts the transmitted CAT signal into USB 2.0, Ethernet, RS-232 and audio signals.

**EXT3-UE-R** provides exceptional quality, advanced and user-friendly operation, and flexible control:

### Exceptional Quality

- **Comprehensive USB Extension** – Plug & play USB over CAT receiver for connecting a remote USB host to the locally connected USB peripherals, employing either interrupt, bulk or isochronous USB 2.0 standard data transfer communication.
- **Simple USB Peripheral Control** – Remote IP-driven or serial control, via the

CAT-extended control signals of the connected USB peripherals, such as PTZ cameras and soundbars by a remote LAN-connected control system (for example, Kramer Control).

- Flexible USB Connectivity – Wide Variety of USB peripheral and dual-role devices can be extended including cameras, touch screens, smart boards, hard drives, game controllers, audio devices, printers, scanners, or HID (Human Interface Devices) devices such as a mouse or keyboard.

### Advanced and User-friendly Operation

- USB Peripheral Charging – Fast USB charging of connected USB peripherals when the receiver is powered by a power supply, and standard USB charging when the receiver is powered by the transmitter via CAT.

### Flexible Connectivity

- Bidirectional Ethernet Extension – LAN interface data flows in both directions, allowing network data transmission and connected-devices control.
- Bidirectional RS-232 Extension – Serial interface data flows in both directions, allowing data transmission and device control.
- Audio Extension – The transmitted analog audio line signal from the remote audio source is connected to the locally connected audio playing device.
- Comprehensive and Cost-effective Management – Local panel indication LEDs facilitate easy local maintenance and troubleshooting. Remote management of connected triggerable I/O devices (such as sensors), via user-friendly embedded web pages and optional whole site management system, ensure lasting and field proven deployment.
- Easy Installation – Single twisted-pair cable for carrying signal and power wiring. Compact TOOLS® fan-less enclosure for device-back mounting, or side-by-side mounting of 3 units in a 1U rack space with the recommended rack adapter.

## EXT3-U-R USB Receiver

**EXT3-U-R** is a comprehensive, extended-reach CAT extender kit for USB 2.0, RS-232 and audio signals and 2-way powering over twisted pair. The **EXT3-U-R** transmitter converts the USB input signal into a CAT signal. The **EXT3-U-R** receiver converts the transmitted CAT signal into a USB signal.

**EXT3-U-R** provides exceptional quality, advanced and user-friendly operation, and flexible control:

### Exceptional Quality

- Comprehensive USB Extender – Plug & play USB extender kit for providing extended-reach CAT signals and 2-way power over twisted pair copper infrastructures. A local USB host is auto-connected to remote-connected USB devices employing either interrupt, bulk or isochronous USB 2.0 standard data transfer communication.
- Flexible USB Connectivity – Wide Variety of USB peripheral devices can be extended including cameras, touch screens, smart boards, hard drives, game controllers, audio devices, printers, scanners, or HID (Human Interface Devices) devices such as a mouse or keyboard. Dual role and OTG (On The Go) devices such as smart phones and

tablets, connected either to a transmitter-side USB host port or receiver-side USB device port, can communication with a remote host or peripheral pairing device.

### Advanced and User-friendly Operation

- Remote USB Charging – Fast USB charging of peripheral devices when the receiver is powered by a power supply, and standard USB charging when the receiver is powered by the transmitter via CAT.

### Flexible Connectivity

- Bidirectional RS-232 Extension – Serial interface data flows in both directions, allowing data transmission and device control.
- Audio Extension – Send an audio signal from an audio source connected to the transmitter to an active audio playing device connected to the receiver.
- Cost-Effective Maintenance – Status LED indicators facilitate easy local maintenance and troubleshooting.
- Easy Installation – Single twisted-pair cable for signal and power wiring. Compact PicoTOOLS® fan-less enclosure for device-back mounting, or side-by-side mounting of 4 units in a 1U rack space with the recommended rack adapter.

## ACC3-12-SP 1:2 CAT cable splitter

**ACC3-12-SP** is a passive splitter of one 4-pair signals-carrying CAT cable to two 2-pair signals-carrying CAT cables, for optimized deployment of extension copper wiring infrastructure.

---

## Typical Applications

- Enterprise and education online meeting rooms.
- Upgrade AV meeting rooms to hybrid meeting rooms.
- Any solution with flexible connection of multiple USB hosts and local or remote room peripherals.

## Controlling your SWT3-41-U-T

Control your **SWT3-41-U-T** directly via the front panel push buttons, or:

- Via the IP commands transmitted by a controller and touch screen system, or a browser using built-in user-friendly Web pages.
- By RS-232 serial commands transmitted by a touch screen system, PC, or a serial controller.

# Defining SWT3-41-U-T 4x1 USB Switcher

This section defines SWT3-41-U-T, EXT3-UE-R, EXT3-U-R and ACC3-12-SP.

## Defining SWT3-41-U-T

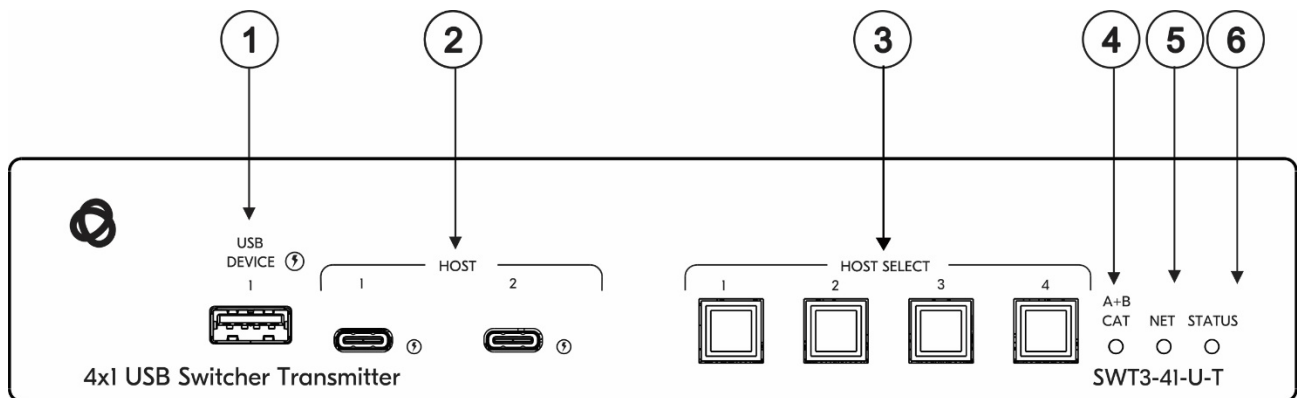
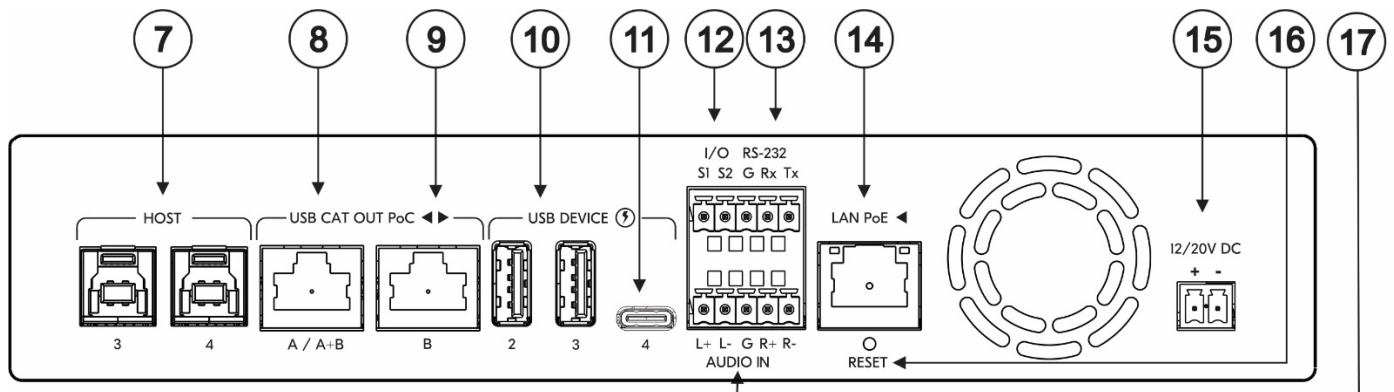

Figure 1: SWT3-41-U-T 4x1 USB Switcher Front Panel

Feature	Function	
① USB DEVICE USB A 3.2 Ports	Connect to the USB local peripheral devices (for example, a USB camera, a soundbar, microphone and so on).	
② HOST on USB-C 3.2 ports (1 to 2)	Connect to a USB-C host (for example, a room PC) to communicate with the USB devices (for example, a PTZ camera) that are connected to the USB device ports and connect to the LAN. <b>For Host 1 only:</b> Charges the connected host (that supports USB Power Delivery 2.0) up to 60W when the device is powered via the optional 12V DC power adapter. While charging, the charging icon (to the right of the connector) becomes visible and lights orange.	
③ HOST SELECT Buttons (1 to 4)	Press to select a host.	
④ A+B CAT LED	<b>LED Status</b>	<b>Indicates</b>
	Lights green	When dual CAT combined signals are sent over the A+B port. <b>i</b> When using CAT splitter, make sure the Dual CAT extension is set to active via SWT3-41-U-T embedded webpages. See <a href="#">Enabling Combined Dual CAT A+B Mode</a> on Page 33.
⑤ NET LED	<b>LED Status</b>	<b>Indicates</b>
	Dark	No IP address acquired.
	Lights green	A valid IP address has been acquired.
	Flashes green for 60s	A means to identify the device in a system, using command #IDV.
⑥ STATUS LED	<b>LED Status</b>	<b>Indicates</b>
	Dark	Power is off



Feature	Function
Lights white	PSU-powered on (only). Note: This is applicable when power supply is PoE mode.
Lights yellow	PoE-powered on.
Lights green	Power is on and a source is connected.
Lights blue	Power is on, and a source and an acceptor are connected.

Figure 2: **SWT3-41-U-T** 4x1 USB Switcher Rear Panel

#	Feature	Function
⑦	HOST USB B 3.2 Connectors (3 to 4)	Connect to a USB host (for example, a room PC) to communicate with the USB devices (for example, a PTZ camera) connected to USB device ports on this device and connect to the LAN.
⑧	USB CAT OUT PoC	A / A+B
⑨	◀▶	B
⑩	USB DEVICE	USB-A 3.2 Ports (2 to 3)
⑪		USB-C 3.2 Port (4)
⑫	I/O 2-pin Terminal Block (S1, S2, G)	Connect to: <ul style="list-style-type: none"> <li>Input-triggering devices (for example, remote buttons or sensors), <b>OR</b></li> <li>Output-triggered devices (for example, remote alarm LED indication).</li> </ul> These GPIO ports may be configured as a digital input, digital output, or analog input ports.
⑬	RS-232 3-pin Terminal Block Connector (G, Rx, Tx)	Connect to: <ul style="list-style-type: none"> <li>RS-232 controlled device (for example, a PTZ USB camera) for its remote IP control by a controller (for example, an SL-240C), <b>OR</b></li> <li>RS-232 control port of a controller (for example, an SL-240C) for extension via a CAT port, <b>OR</b></li> <li>PC RS-232 port for controlling the device.</li> </ul>
⑭	LAN PoE ◀ RJ-45 Connector	Connect to LAN. The device accepts power from the LAN port (PoE). A LAN-enabled connection on the selected USB-C port is LAN-switched via this LAN port.
⑮	12/20V DC Power Connector	Use the included +20V 6A power supply for powering the unit and charging the source device connected to the USB-C port, or For powering the unit, without USB-C charging support, use PoE powering or an optional +12V DC 5A power adapter (purchased separately).
⑯	RESET Recessed Button	Press and hold while powering the device to reset to factory default values, including IP Settings.

#	Feature	Function
17	AUDIO IN 5-pin Terminal Block Connector	Connect to a balanced, stereo audio source (for example, from the server) for extension via the CAT ports.

## Defining EXT3-UE-R

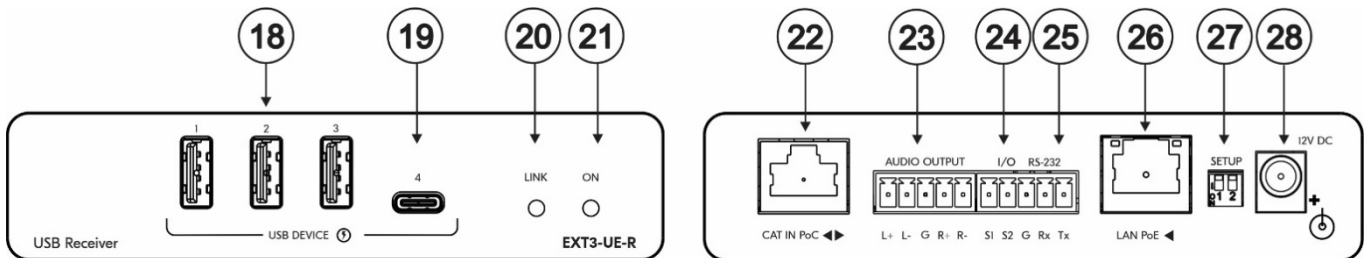

Figure 3: EXT3-UE-R USB Receiver Front/Rear Panel

#	Feature	Function										
18	USB 2 Type A Ports (1 to 3)	Connect to USB local devices (for example, a USB camera, a soundbar, microphone etc.). Ports provide standard USB device charging.										
19	USB-C Port (4)	Connect to USB local devices (for example, a USB camera, a soundbar, microphone etc.). Port provides LAN standard USB device charging. Note: Port does not provide Power Delivery 2.0 charging.										
20	LINK LED	Flashes blue when a link is established.										
21	ON LED	Lights green when locally powered by the power adapter. Lights orange when powered by PoC.										
22	CAT IN PoC RJ-45 Connector	Connect to: <ul style="list-style-type: none"> <li>One of the USB CAT OUT PoC ports on the <b>SWT3-41-U-T OR</b>, CAT A or CAT B on the <b>ACC3-12-SP 1:2</b> CAT cable splitter which can be connected to the <b>SWT3-41-U-T</b>.</li> </ul>										
23	AUDIO OUTPUT 5-pin Terminal Block Connector (L+, L-, G)	Connect to a balanced analog stereo audio line acceptor.										
24	I/O 2-pin Terminal Block (S1 to S2)	Connect to: <ul style="list-style-type: none"> <li>Input-triggering devices (for example, remote buttons or sensors), <b>OR</b></li> <li>Output-triggered devices (for example, remote alarm LED indication).</li> </ul> These GPIO ports may be configured via paired <b>SWT3-41-U-T</b> embedded webpages, as digital input or output ports.										
25	RS-232 3-pin Terminal Block (G, Rx, Tx)	Connect to an RS-232 controlled device (for example, the connected PTZ USB camera) to be controlled via a controller (for example, <b>SL-240C</b> ) which is IP-connected to a paired <b>SWT3-41-U-T</b> .										
26	LAN PoE RJ-45 Connector	Connect to LAN or to an IP-controlled device (for example, the connected PTZ USB camera). The device accepts power from the LAN port.										
27	SETUP 2-way DIP-switch	Note: All changes in DIP-Switches apply immediately. <table border="1" style="width: 100%; border-collapse: collapse;"> <thead> <tr> <th>DIP-switch Name</th> <th>DIP-switch #</th> <th>DIP-Switch State</th> <th>State Description</th> </tr> </thead> <tbody> <tr> <td rowspan="2">RS-232 MODE</td> <td rowspan="2">1</td> <td>OFF (up) default</td> <td>Programming mode</td> </tr> <tr> <td>ON (down)</td> <td>Extension mode</td> </tr> </tbody> </table>	DIP-switch Name	DIP-switch #	DIP-Switch State	State Description	RS-232 MODE	1	OFF (up) default	Programming mode	ON (down)	Extension mode
DIP-switch Name	DIP-switch #	DIP-Switch State	State Description									
RS-232 MODE	1	OFF (up) default	Programming mode									
		ON (down)	Extension mode									

		For future use	2	Mandatory OFF (up)
28	12V DC Power Connector	Connect to the power adapter.		

## Defining EXT3-U-R

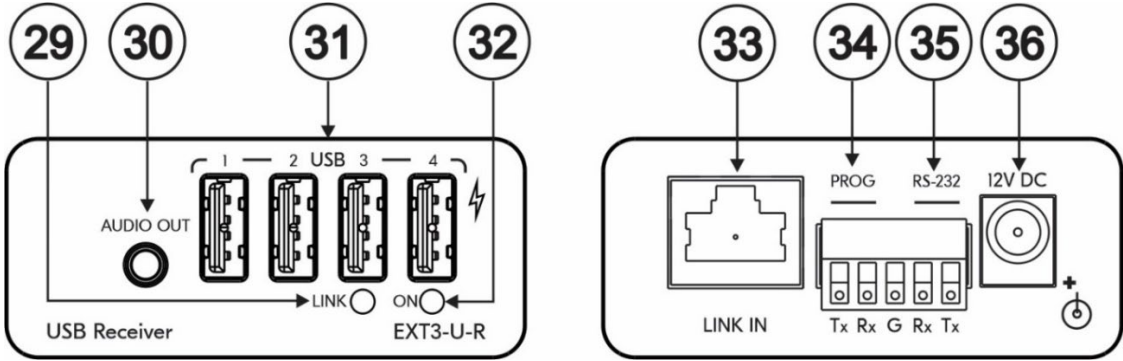

Figure 4: EXT3-U-R USB Receiver Front/Rear Panel

#	Feature	Function
29	LINK LED	Flashes blue when a link is established.
30	AUDIO OUT 3.5mm Mini Jack	Connect to an unbalanced stereo audio acceptor.
31	USB 2 Type A Ports (1 to 4)	Connect to USB devices. Connect the receiver directly to the power adapter in order to charge USB devices.
32	ON LED	Lights green when locally powered by the power adapter. Lights orange when powered by PoC.
33	LINK IN RJ-45 Connector	Connect to the LINK OUT port on the EXT3-UE-R.
34	PROG (Tx, Rx)	5-pin Terminal Block Connector (with common G pin)
35	RS-232 (Rx, Tx)	Press to toggle between a blank screen (blue or black) and the program display. The BLANK button can be programmed to mute the audio signal at the same time.
36	12V DC Power Connector	Connect to the power adapter.

# Defining ACC3-12-SP

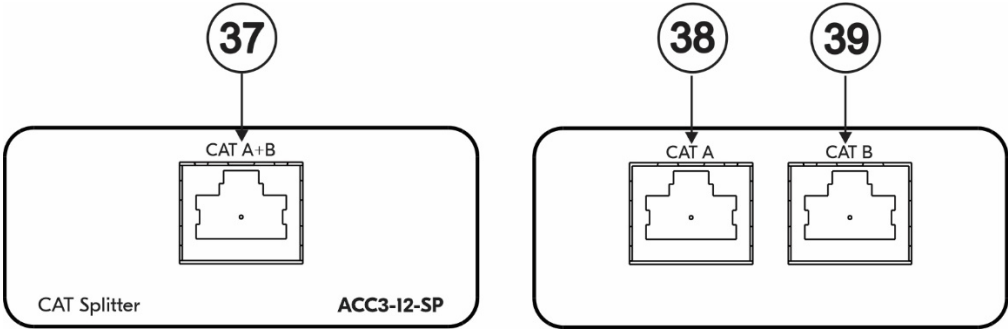

Figure 5: ACC3-12-SP 1:2 CAT cable splitter Front/Rear Panel

#	Feature	Function
37	CAT A+B RJ-45 Port	Connect to a compatible CAT transmitter (for example an <b>SWT3-41-U-T</b> ) so send combined signals over the A+B port. ⓘ Make sure the Dual CAT extension is set to active via CAT transmitter embedded webpages.
38	CAT A RJ-45 Port	Connect to a compatible CAT receiver (for example an <b>EXT3-UE-R</b> , <b>EXT3-U-R</b> ).
39	CAT B RJ-45 Port	Connect to a compatible CAT receiver (for example an <b>EXT3-UE-R</b> , <b>EXT3-U-R</b> ).

# Mounting SWT3-41-U-T, EXT3-UE-R, EXT3-U-R, and ACC3-12-SP

---

## Mounting SWT3-41-U-T

This section provides instructions for mounting **SWT3-41-U-T**. Before installing, verify that the environment is within the recommended range:



- Operation temperature – 0° to 40°C (32 to 104°F).
- Storage temperature – -40° to +70°C (-40 to +158°F).
- Humidity – 10% to 90%, RHL non-condensing.



### Caution:

- Mount **SWT3-41-U-T** before connecting any cables or power.



### Warning:

- Ensure that the environment (e.g., maximum ambient temperature & air flow) is compatible for the device.
- Avoid uneven mechanical loading.
- Appropriate consideration of equipment nameplate ratings should be used for avoiding overloading of the circuits.
- Reliable earthing of rack-mounted equipment should be maintained.
- Maximum mounting height for the device is 2 meters.

### Mount SWT3-41-U-T in a rack:

- Use the recommended rack adapter  
(see [www.kramerav.com/product/SWT3-41-U-T](http://www.kramerav.com/product/SWT3-41-U-T)).

### Mount SWT3-41-U-T on a surface using one of the following methods:

- Mount device with its recommended mounting accessory to the underside of the table and secure.
- Attach the rubber feet and place the unit on a flat surface.
- Mount the unit in a rack using the recommended rack adapter [www.kramerav.com/downloads/SWT3-41-U-T](http://www.kramerav.com/downloads/SWT3-41-U-T).

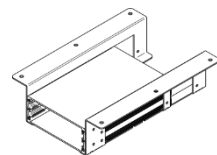

## Mounting EXT3-UE-R

This section provides instructions for mounting **EXT3-UE-R**. Before installing, verify that the environment is within the recommended range:



- Operation temperature – 0° to 40°C (32 to 104°F).
- Storage temperature – -40° to +70°C (-40 to +158°F).
- Humidity – 10% to 90%, RHL non-condensing.



- **EXT3-UE-R** must be placed upright in the correct horizontal position.



### Warning:

- Ensure that the environment (e.g., maximum ambient temperature & air flow) is compatible for the device.
- Avoid uneven mechanical loading.
- Appropriate consideration of equipment nameplate ratings should be used for avoiding overloading of the circuits.
- Reliable earthing of rack-mounted equipment should be maintained.

### Mounting EXT3-UE-R



Mount device before connecting any cables or power.

#### To mount EXT3-UE-R

Mount the unit in a rack using the recommended rack adapter (see [www.kramerav.com/product/EXT3-UE-R](http://www.kramerav.com/product/EXT3-UE-R))

#### To mount the EXT3-UE-R on a table or shelf:

- Attach the rubber feet and place the unit on a flat surface.
- Fasten a bracket (included) on each side of the unit and attach it to a flat surface.

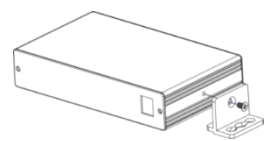

For more information go to [www.kramerav.com/downloads/EXT3-UE-Rr](http://www.kramerav.com/downloads/EXT3-UE-Rr)

## Mounting EXT3-U-R

This section provides instructions for mounting **EXT3-U-R**. Before installing, verify that the environment is within the recommended range:



- Operation temperature – 0° to 40°C (32 to 104°F).
- Storage temperature – -40° to +70°C (-40 to +158°F).
- Humidity – 10% to 90%, RHL non-condensing.



### Caution:

- Mount **EXT3-U-R** before connecting any cables or power.



### Warning:

- Ensure that the environment (e.g., maximum ambient temperature & air flow) is compatible for the device.
- Avoid uneven mechanical loading.
- Appropriate consideration of equipment nameplate ratings should be used for avoiding overloading of the circuits.
- Reliable earthing of rack-mounted equipment should be maintained.
- Maximum mounting height for the device is 2 meters.

### Mount EXT3-U-R in a rack:

- Use the recommended rack adapter  
(see [www.kramerav.com/product/EXT3-U-R](http://www.kramerav.com/product/EXT3-U-R)).

### Mount EXT3-U-R on a surface using one of the following methods:

- Attach the rubber feet and place the unit on a flat surface.
- Fasten a bracket (included) on each side of the unit and attach it to a flat surface. For more information go to [www.kramerav.com/downloads/EXT3-U-R](http://www.kramerav.com/downloads/EXT3-U-R).

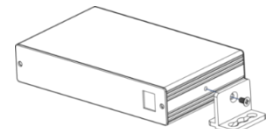

## Mounting ACC3-12-SP

This section provides instructions for mounting **ACC3-12-SP**. Before installing, verify that the environment is within the recommended range:



- Operation temperature – 0° to 40°C (32 to 104°F).
- Storage temperature – -40° to +70°C (-40 to +158°F).
- Humidity – 10% to 90%, RHL non-condensing.

**Caution:**

- Mount **ACC3-12-SP** before connecting any cables.

**Warning:**

- Ensure that the environment (e.g., maximum ambient temperature) is compatible for the device.
- Avoid uneven mechanical loading.
- Reliable earthing of rack-mounted equipment should be maintained.

**Mount ACC3-12-SP in a rack:**

- Use the recommended rack adapter  
(see [www.kramerav.com/product/ACC3-12-SP](http://www.kramerav.com/product/ACC3-12-SP)).

**Mount ACC3-12-SP on a surface using one of the following methods:**

- Attach the rubber feet and place the unit on a flat surface.
- Fasten a bracket (included) on each side of the unit and attach it to a flat surface. For more information go to [www.kramerav.com/downloads/ACC3-12-SP](http://www.kramerav.com/downloads/ACC3-12-SP).

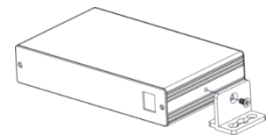



# Connecting SWT3-41-U-T

**i** Always switch off the power to each device before connecting it to your **SWT3-41-U-T**. After connecting your **SWT3-41-U-T**, connect its power and then switch on the power to each device.

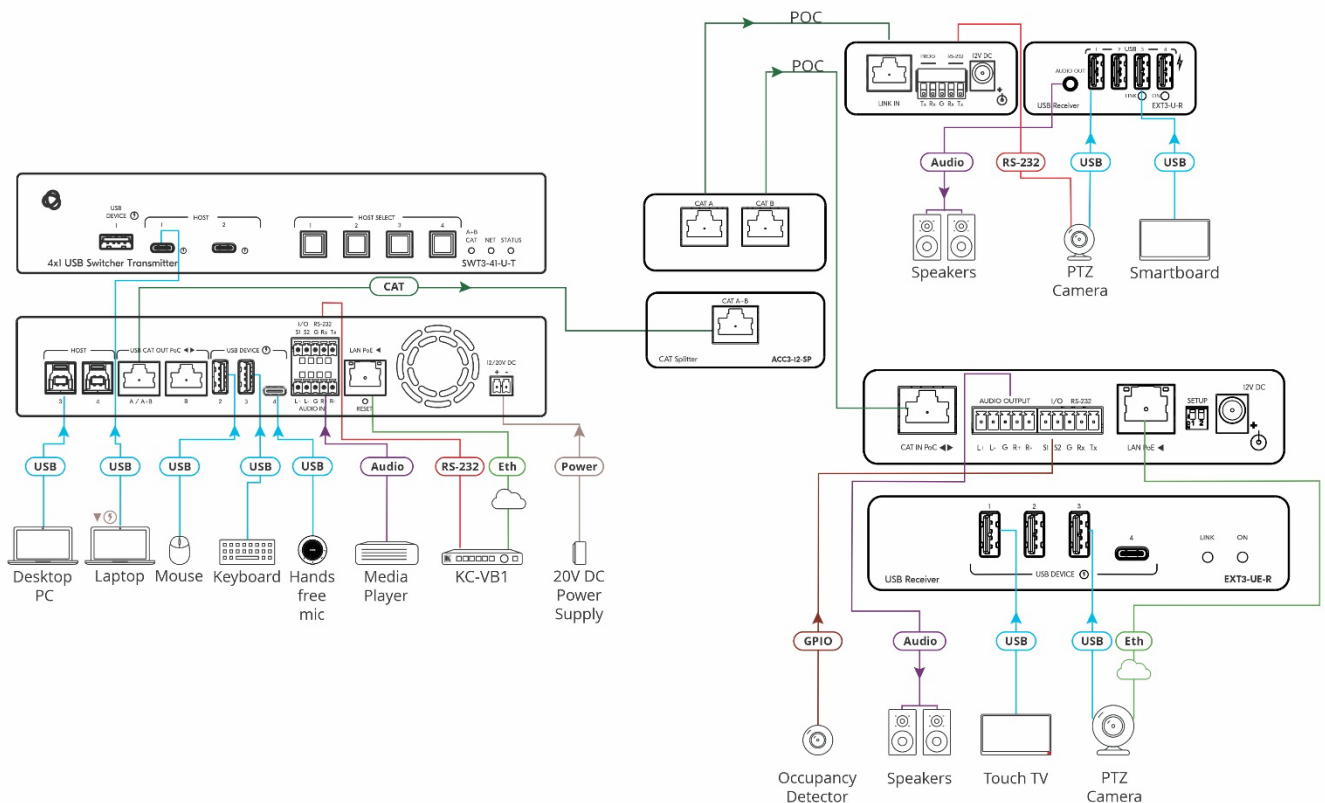

Figure 6: Connecting to the SWT3-41-U-T

**i** In (Figure 6) **SWT3-41-U-T** is connected to dual receivers using a CAT splitter to save CAT cables wiring expenses. If not CAT splitter is required, **SWT3-41-U-T** can connect directly to either one of the required receivers **EXT3-UE-R** and **EXT3-U-R** based on needs.

**To connect SWT3-41-U-T as illustrated in the example in Figure 6:**

- i**
  - USB devices that consume power greater than the power supplied by connected port (see Technical Specifications), should be powered by an external power supply.
- Connect the HOST USB-C 3.2 (2) port to a laptop.
- Connect the HOST USB-B 3.2 (7) port to a room PC.
- Connect the local USB DEVICE ports (1), (10), (11) to USB devices (for example, USB DEVICE 2 to a mouse, USB DEVICE 3 to a keyboard and USB DEVICE 4 to a hands-free mic).
- Connect a balanced stereo audio source (for example, media player) to the AUDIO IN 5-pin terminal block connector (17).

1. Connect the USB CAT OUT A / A+B PoC RJ-45 port (8) on the **SWT3-41-U-T** , to the CAT A+B Input RJ-45 port (36) on the **ACC3-12-SP**.
2. Connect the CAT A RJ-45 Output Ports (8) on the **ACC3-12-SP** , to the LINK IN RJ-45 ports (22) & (33) on the **EXT3-UE-R** and **EXT3-U-R**, correspondently.
3. Connect the Outputs on **EXT3-U-R** as follows:
  - Connect the USB DEVICE ports (31) to USB devices (for example, USB DEVICE 1 to a Touch TV, USB DEVICE 2 to a PTZ camera and USB DEVICE 3 to a smartboard).
  - Connect the AUDIO OUT 3.5mm mini jack (30) to an unbalanced stereo audio acceptor (for example, active speakers).
4. Connect the Outputs on **EXT3-UE-R** as follows:
  - Connect the USB DEVICE ports (18) to USB devices (for example, USB 1 to a touch TV, USB 3 to a PTZ camera).
  - Connect the AUDIO OUTPUT 5-pin terminal block connector (23) to a balanced stereo audio acceptor (for example, active speakers).
  - Connect the I/O 2-pin terminal block connector (24) to a triggering and/or triggered GPIO acceptor (for example, I/O 2 to occupancy detector) or a remote button (for example, a host selector).
5. Control the devices:
  - On the **SWT3-41-U-T**, connect a controller (for example, **KC-VB1** room controller) to the LAN PoE ◀ RJ-45 port (14), or to the RS-232 port (13).
  - On **EXT3-U-R** receiver side, connect the RS-232 port (16) to a PTZ camera (send serial commands from **SL-240C** to the camera via receiver RS-232 port).
  - On **EXT3-U-R** receiver side, connect the LAN PoE ◀ RJ-45 port to a PTZ camera (send IP commands from **SL-240C** to the camera via receiver LAN port).
6. When not PoE powered, connect the power adapter to **SWT3-41-U-T** and to the mains electricity.



To charge the device that is connected to the host USB-C port, you need to use a power adapter for powering the **SWT3-41-U-T** switcher transmitter.

## Connecting the Output to a Balanced/Unbalanced Stereo Audio Acceptor

The following are the pinouts for connecting the output to a balanced or unbalanced stereo audio acceptor:

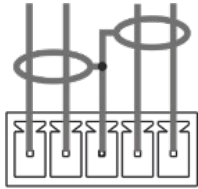

L+ L- G R+ R-

Figure 7: Connecting to a Balanced Stereo Audio Acceptor

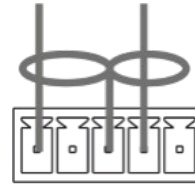

L+ L- G R+ R-

Figure 8: Connecting to an Unbalanced Stereo Audio Acceptor

## Connecting a Balanced/Unbalanced Stereo Audio Source to the Balanced Input

The following are the pinouts for connecting a balanced or unbalanced stereo audio source to the balanced input:

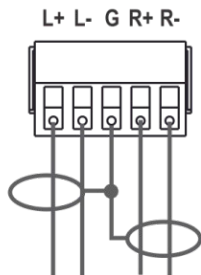

Figure 9: Connecting a Balanced Stereo Audio Source to the Balanced Input

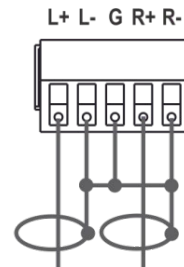

Figure 10: Connecting an Unbalanced Stereo Audio Source to the Balanced Input

# Connecting to Devices via RS-232

You can connect to **SWT3-41-U-T/ EXT3-UE-R/ EXT3-U-R** via an RS-232 connection using, for example, a PC.

**SWT3-41-U-T**, for example, features an RS-232 3-pin terminal block connector allowing the RS-232 to control **SWT3-41-U-T**.

Connect the RS-232 terminal block on the rear panel of **SWT3-41-U-T** to a PC/controller, as follows:

From the RS-232 9-pin D-sub serial port connect:

- Pin 2 to the TX pin on the **SWT3-41-U-T** RS-232 terminal block
- Pin 3 to the RX pin on the **SWT3-41-U-T** RS-232 terminal block
- Pin 5 to the G pin on the **SWT3-41-U-T** RS-232 terminal block

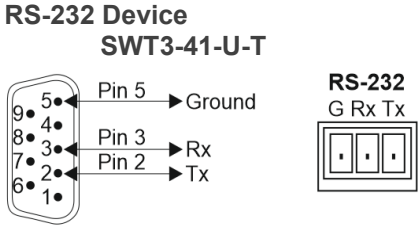

# Operating and Controlling SWT3-41-U-T

---

## Principles of Operation

This section covers the following topics:

- [Flexible SWT3-41-U-T Auto Switching Policy](#) on page [19](#).
- [Online Meeting Systems Integration](#) on page [20](#).
- [Routing IP-Driven Control Signals via Built-in Control Gateway](#) on page [20](#).
- [Muting Extended Audio Signals](#) on page [21](#).
- [Flexible Remote Buttons Control](#) on page [21](#).

## Flexible SWT3-41-U-T Auto Switching Policy

Set the USB host switching to connected USB devices policy to:

- Manual – Select a USB host manually and switching occurs whether a USB host live signal is present or not.
- Auto – Auto Switching selection is performed in either Last Connected or Priority policy.

In Last Connected policy:

- If a signal is plugged in this mode, **SWT3-41-U-T** will switch to it.
- If the signal on the current input is lost, **SWT3-41-U-T** automatically selects the last connected input.



The auto-switching delay depends on the configurable signal-lost timeout

In Priority policy:

- If a signal with a higher priority than the current one is plugged in this mode, **SWT3-41-U-T will switch to it.**
- When the input sync signal is lost for any reason, the input with a live signal and next in priority is selected automatically.



The auto-switching delay depends on the configurable signal-lost timeout. Inputs priority is configurable; the default setting is USB-C 1 → USB C 2 → USB 3 → USB 4.



In both Last Connected and Priority modes, manually selecting an input (using the front panel, remote or web UI input select button) overrides automatic selection

See [Setting the USB Auto-Switching](#) Policy on page [30](#).

## Online Meeting Systems Integration

USB device ports can be set to auto-disconnect following presenter disconnection, to allow smooth integration and auto-activation of connected online meeting room systems.

See [Auto-disconnecting a USB Device on Inactive Host](#) on page 37.

## Routing IP-Driven Control Signals via Built-in Control Gateway

Remote IP connected clients can communicate and control (send commands, and receive responses and notifications) via the LAN:

- IP commands/responses via the LAN-connected **SWT3-41-U-T** and CAT-connected **EXT3-UE-R** LAN extension, to/from the **EXT3-UE-R** LAN-connected devices.
- Via the **SWT3-41-U-T** built-in and I/O control gateway:
  - RS-232 commands, to control devices connected to **SWT3-41-U-T**, **EXT3-UE-R** and **EXT3-U-R** RS-232 control ports. The built-in control gateway sends the serial control commands (converted from the client received IP messages) to the locally and/or remotely connected serially controlled devices and distributes their received responses to all connected clients.
  - Send or receive I/O digital triggers or detected triggers, to I/O control devices connected to **SWT3-41-U-T** and **EXT3-UE-R I/O** control ports. The built-in control gateway sends the I/O control commands (converted from the client received IP messages) to the locally and/or remotely connected I/O controlled devices and distributes their received detected triggers to all connected clients.



EXT3-UE-R I/O ports control and management via LAN is done via **SWT3-41-U-T** LAN connection and web-UI only.

([Figure 11](#)) shows the **SWT3-41-U-T** built-in control gateway connection for control of its local and remote EXT3-UE-R control ports. The Kramer Control controller is connected to the switcher via LAN, sends IP commands to the switcher control gateway over the LAN connection, to send control messages to, and receive control responses from:

- The PTZ Camera connected to the **EXT3-U-R** receiver via the RS-232 port.
- The PTZ Camera connected to the **EXT3-UE-R** receiver via the LAN.
- The Occupancy Detector connected to the **EXT3-UE-R** receiver via the I/O ports.
- The Soundbar is connected to receiver **EXT3-UE-R** via the RS-232 port.
- The Blinds are locally connected to **SWT3-41-U-T** via the I/O ports.

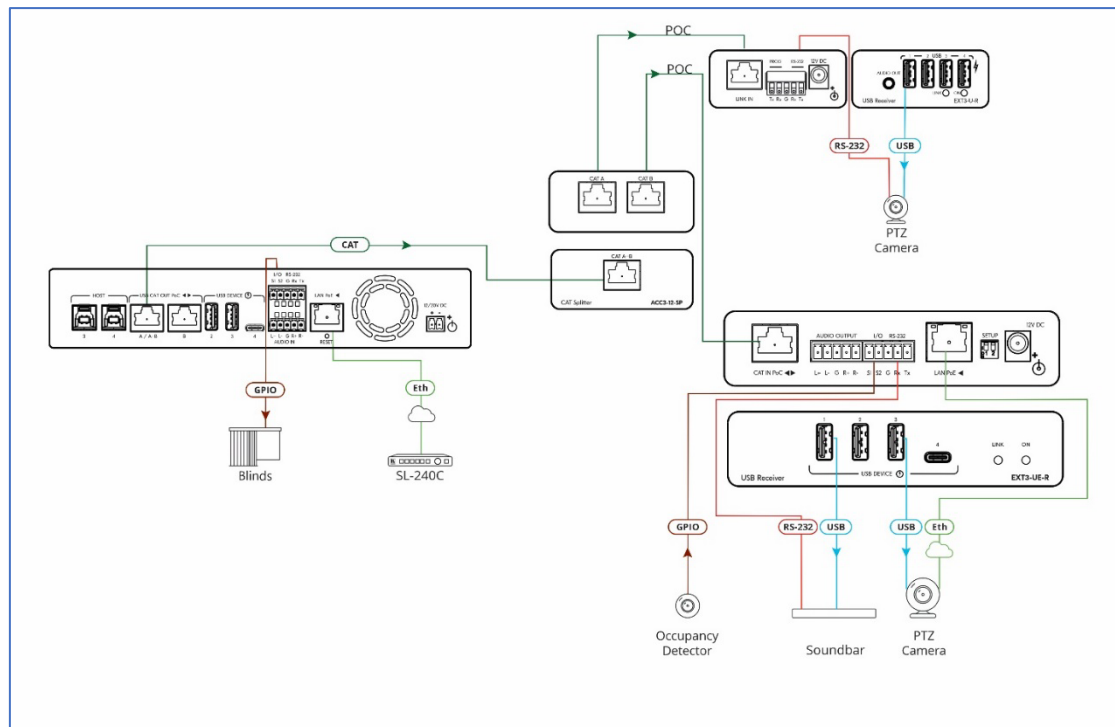

Figure 11: Controlling remotely via SWT3-41-U-T Control Gateway

## Muting Extended Audio Signals

Stereo audio signal is extended from the switcher transmitter to both receivers, to allow easy audio and music distribution within the same space or separate rooms. Each extended audio signal can be independently muted, to enable a simple end-user control on the distributed audio signals.

See [Muting the Extended Audio Signal](#) on page [29](#).

## Flexible Remote Buttons Control

Remote contact-closure buttons can be connected to the I/O ports, for easy end user control of device functions by button press and release operation. Flexible configuration of button press/release actions and latching (default) or momentary operation mode, enable simple and custom control according to user needs.

See [Configuring Remote Buttons](#) on page [48](#).

---

## Using Front Panel Buttons

SWT3-41-U-T front and rear panel buttons enable the following actions:

- Selecting a HOST INPUT.
- Resetting device to its factory settings (for additional instructions on resetting and resetting device (see [Resetting and Restarting Device](#) on page [34](#)).

---

## Operating via Ethernet

You can connect to SWT3-41-U-T via Ethernet using either of the following methods:

- Directly to the PC using a crossover cable (see [Connecting Ethernet Port Directly to a PC](#) on page [22](#)).
- Via a network switch or router, using a straight-through cable (see [Connecting Ethernet Port via a Network Hub or Switch](#) on page [24](#)).



If you want to connect via a router and your IT system is based on IPv6, speak to your IT department for specific installation instructions.

### Connecting Ethernet Port Directly to a PC

You can connect the Ethernet port of **SWT3-41-U-T** directly to the Ethernet port on your PC using a crossover cable with RJ-45 connectors.



This type of connection is recommended for identifying **SWT3-41-U-T** with the factory configured default IP address.

After connecting **SWT3-41-U-T** to the Ethernet port, configure your PC as follows:

1. Click **Start > Control Panel > Network and Sharing Center**.
2. Click **Change Adapter Settings**.
3. Highlight the network adapter you want to use to connect to the device and click **Change settings of this connection**.

The Local Area Connection Properties window for the selected network adapter appears as shown in [Figure 12](#).



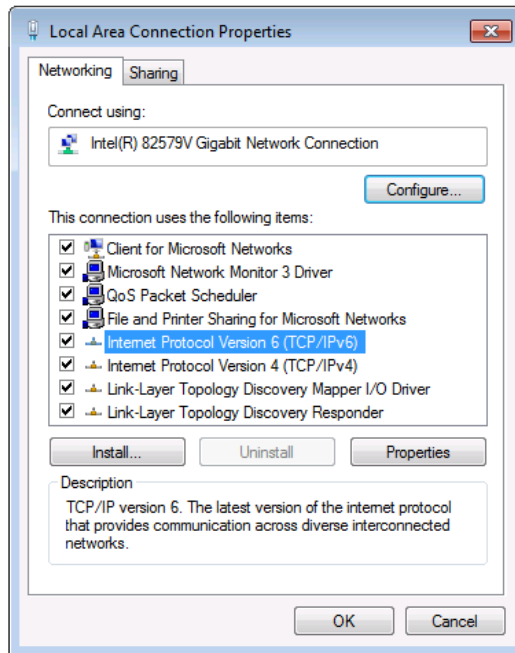

Figure 12: Local Area Connection Properties Window

4. Highlight either **Internet Protocol Version 6 (TCP/IPv6)** or **Internet Protocol Version 4 (TCP/IPv4)** depending on the requirements of your IT system.
5. Click **Properties**.

The Internet Protocol Properties window relevant to your IT system appears as shown in [Figure 13](#) or [Figure 14](#).

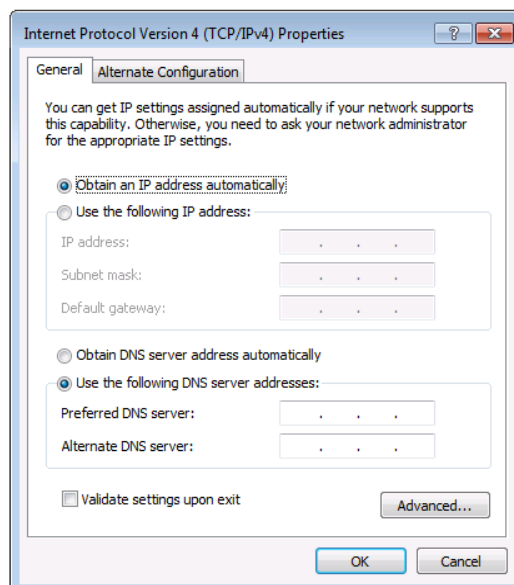

Figure 13: Internet Protocol Version 4 Properties Window

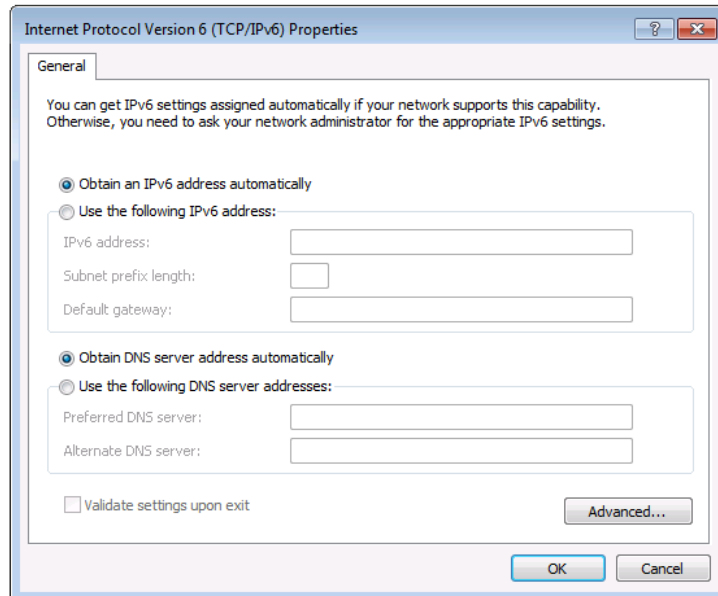

Figure 14: Internet Protocol Version 6 Properties Window

6. Select **Use the following IP Address** for static IP addressing and fill in the details as shown in [Figure 15](#).

For TCP/IPv4 you can use any IP address in the range 192.168.1.1 to 192.168.1.255 (excluding default 192.168.1.39 fallback address) that is provided by your IT department.

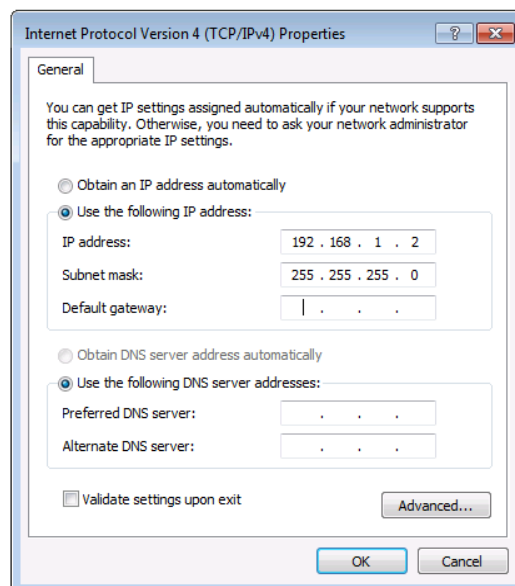

Figure 15: Internet Protocol Properties Window

7. Click **OK**.
8. Click **Close**.

## Connecting Ethernet Port via a Network Hub or Switch

You can connect the Ethernet port of **SWT3-41-U-T** to the Ethernet port on a network switch or router using a straight-through cable with RJ-45 connectors.

## Configuring Ethernet Port

You can set the Ethernet parameters via the embedded Web pages.



## Discovering and acquiring IP address

**SWT3-41-U-T** includes IP address auto-acquiring policy via LAN-connected DHCP server by default. When no DHCP server is detected, a fallback static IP address of 192.168.1.39, and 255.255.255.0 subnet mask (class C), is assigned until an IP address is acquired via the DHCP server.

For more information, refer to Product Page Technical Note in [www.kramerav.com/product/SWT3-41-U-T](http://www.kramerav.com/product/SWT3-41-U-T)

# Using Embedded Web Pages

**SWT3-41-U-T** enables you to configure settings via Ethernet using built-in, user-friendly web pages. The Web pages are accessed using a Web browser and an Ethernet connection.



-  To apply the USB-C type change, device power cycle must be performed.
-  USB-C ethernet connection is disabled by default and is enabled only by API command. (see [Protocol 3000 Commands](#) on page [65](#)).

Before attempting to connect:

- Perform the procedure in (see [Operating via Ethernet](#) on page [22](#)).
- Ensure that your browser is supported.

The following operating systems and Web browsers are supported:

Operating Systems	Browser
Windows 10 and higher	Edge
	Chrome
Mac	Safari
iOS	Safari
Android	N/A

-  If a web page does not update correctly, clear your Web browser's cache.
-  Check that Security/firewalls are not blocking HTTP traffic between the device and the user PC.

**To access the web pages:**

1. Enter the IP address of the device in the address bar of your internet browser (default = 192.168.1.39).

If security is enabled, the Login window appears.

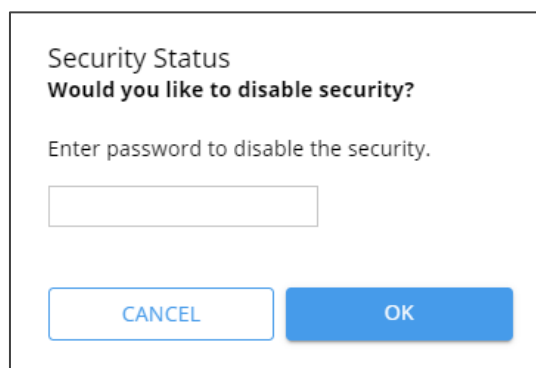

Figure 16: Embedded Web Pages Login Window

2. Enter the Username (default = Admin) and Password (default = Admin) and click **Sign in**. The default web page appears.

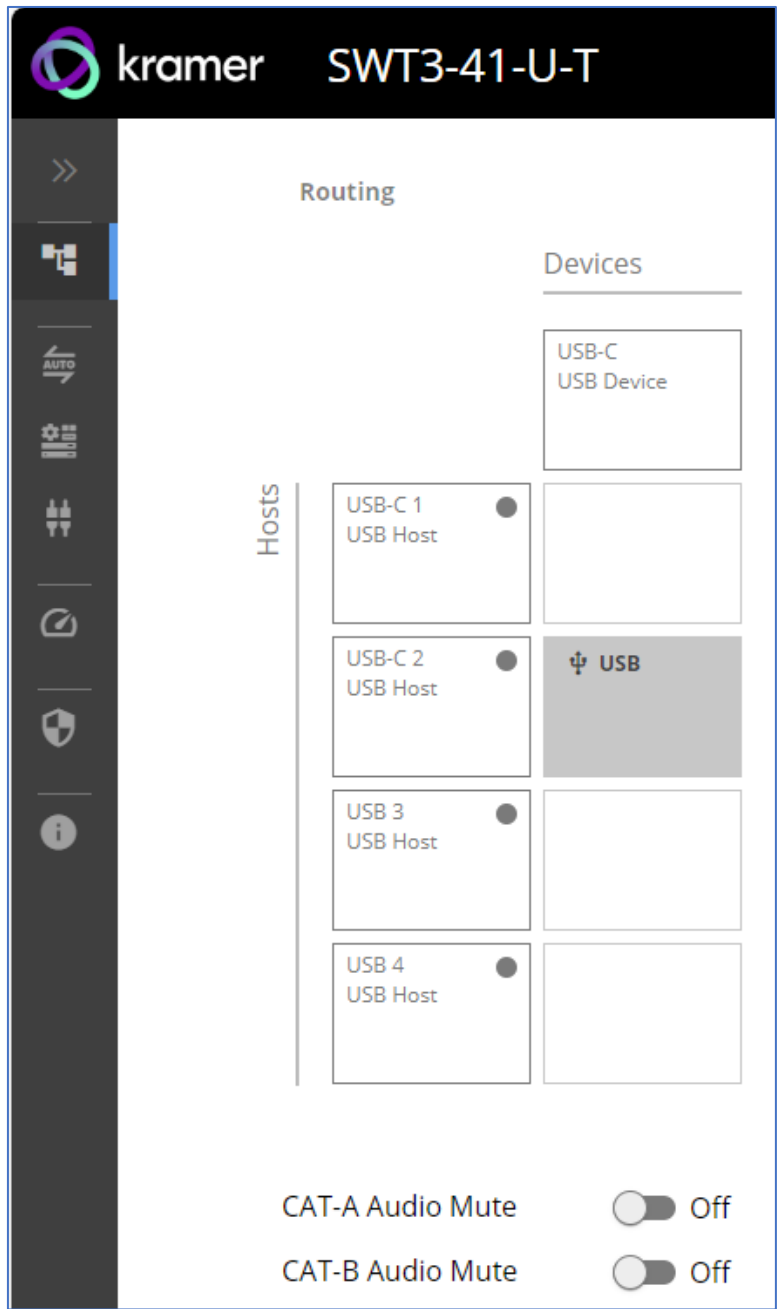

Figure 17: Default Landing Page

- Click the arrow at the top of the navigation list to view the menu items in detail.

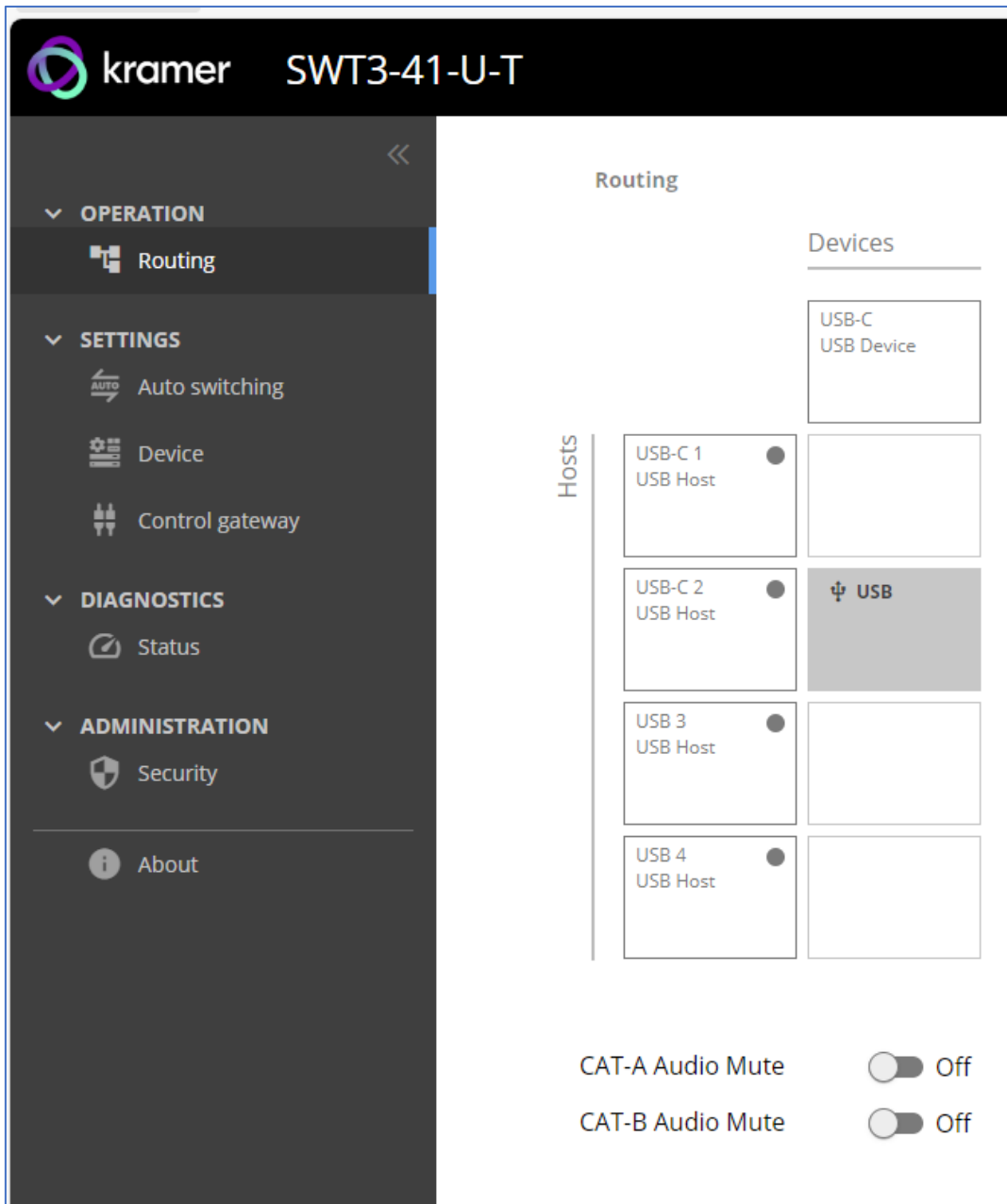

Figure 18: Pages and Tabs Navigable List

- Click the Navigation Pane on the left side of the screen to access the relevant web page.

SWT3-41-U-T web pages enable performing the following actions:

- [Operation](#) on page [29](#).
- [Settings](#) on page [30](#).
- [Diagnostics](#) on page [50](#).
- [Administration](#) on page [50](#).
- [Viewing the About Page](#) on page [56](#).

# Operation

## Routing Signals

This section details the following actions:

- [Routing a Host to Devices](#) on page 29.
- [Muting the Extended Audio Signal](#) on page 29.

### Routing a Host to Devices

Route any of the four USB hosts to all connected USB-C devices.

To route the Host to the Devices:

1. Go to the Routing Settings tab.

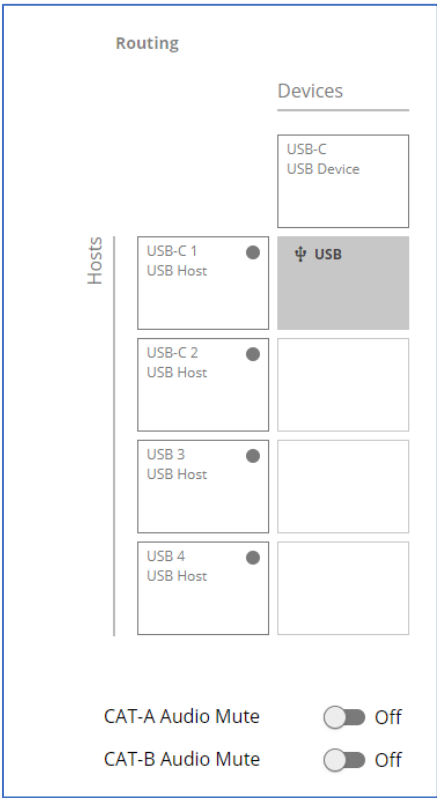

Figure 19: Routing Page

2. Perform the following functions:

- Click a Host/Devices cross-point.



A green light button indicates a connected source.

A host is routed to the devices.

### Muting the Extended Audio Signal:



This feature only works when **SWT3-41-U-T** is connected to a receiver(s).

**To mute the extended audio signal:**

1. Go to the Routing Settings tab.
2. Next to CAT-A /B Audio Mute press to toggle switch to ON.

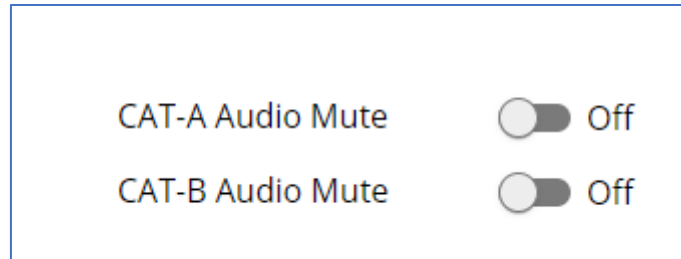

Figure 20: Muting Extended Audio Signals

Extended audio signal is muted.

---

## Settings

This section details the following action:

- [USB Switching Properties](#) on page [30](#).
- [Device Properties](#) on page [31](#).
- [Settings Networking Properties](#) on page [36](#).
- [Control Gateway Properties](#) on page [39](#).

### USB Switching Properties

This section details the following action:

- [Setting the USB Auto-Switching](#) Policy on page [30](#).

#### Setting the USB Auto-Switching Policy

**To set the USB auto-switching policy:**

1. Go to the Auto switching tab.
2. Next to the Selection Mode drop-down box, select the auto switching policy: **Manual**, **Last Connected** or **Priority**.

USB auto-switching policy is set.

**To change USB Host Input Priorities:**

1. Go to the Auto switching tab.
2. Next to the Selection Mode drop-down box, select **Priority**.



3. Click and drag a host input between high and low to change the priorities.

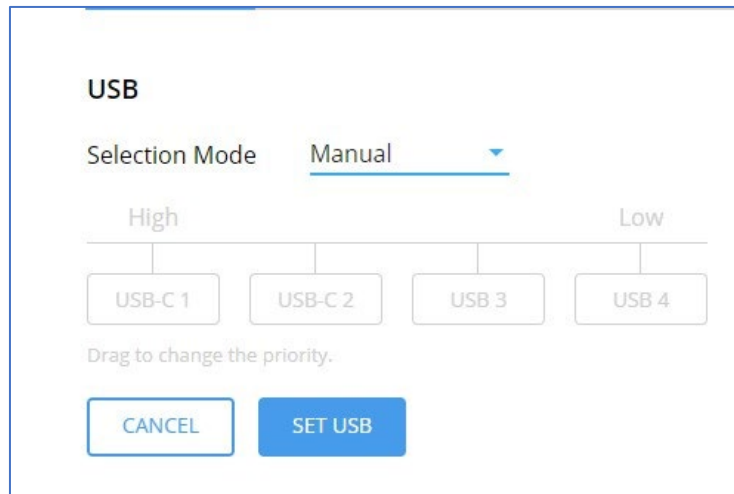

Figure 21: Changing Input Priorities

4. Click **SET USB**.

USB Host Input priorities are set.

## Device Properties

This section details the following actions:

- [Device Profile and Maintenance](#) on page [32](#).
- [Changing Device Name](#) on page [32](#).
- [Upgrading Firmware](#) on page [33](#).
- [Resetting and Restarting Device](#) on page [34](#).
- [Identifying Your Device](#) on page [35](#).

## Device Profile and Maintenance

### Changing Device Name

SWT3-41-U-T enables you to change the DNS name of the device.

To change the device name:

1. Go to the Device > General tab.

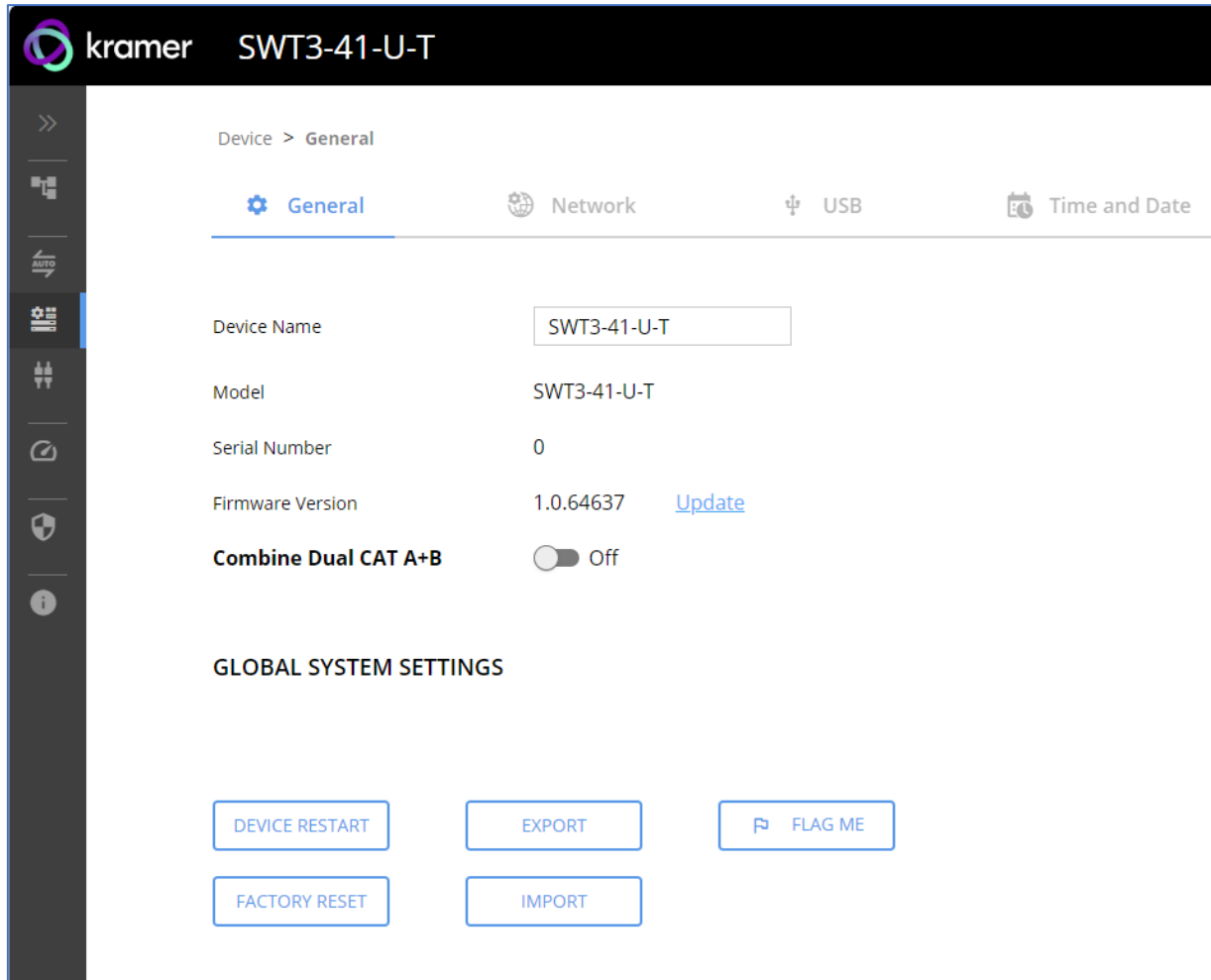

Figure 22: Device > General Page

2. Under General Preferences, change the device name and click **SAVE**.

The device name is changed.

## Upgrading Firmware

To upgrade the device firmware:

1. Go to the **Device > General** tab ([Figure 22](#)).
2. Under General, click **Update**, open the relevant firmware file, and follow the instructions. The upgrade process ([Figure 23](#)) takes approximately 30-60 seconds.



- During FW upgrade, the device continues to operate, but the device UI and protocol 3000 communication are inactive. When device restarts, the status LED is lit and USB host and devices connection signal is disconnected until restart completes.

Firmware is updated.

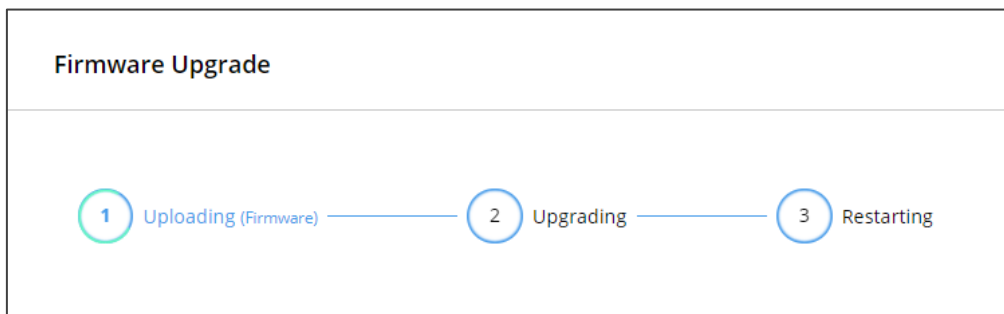

Figure 23:Firmware Upgrade Process

### Enabling Combined Dual CAT A+B Mode

The **SWT3-41-U-T** enables you to connect it to a compatible CAT receiver (**EXT3-UE-R**) or compatible CAT splitter (**ACC3-12-SP**). When you select Combine Dual CAT A+B, the **SWT3-41-U-T** sends combined signals over the A+B Port.



Any device connected to the CAT B Port will not function while this feature is active.

### To configure Dual CAT A+B Mode

1. Go to the **Device > General** tab ([Figure 22](#)).
2. Next to **Combine Dual CAT A+B**, press to toggle On.

### 3. Click **SAVE**.

Dual CAT A+B Mode indication is displayed on the top bar.

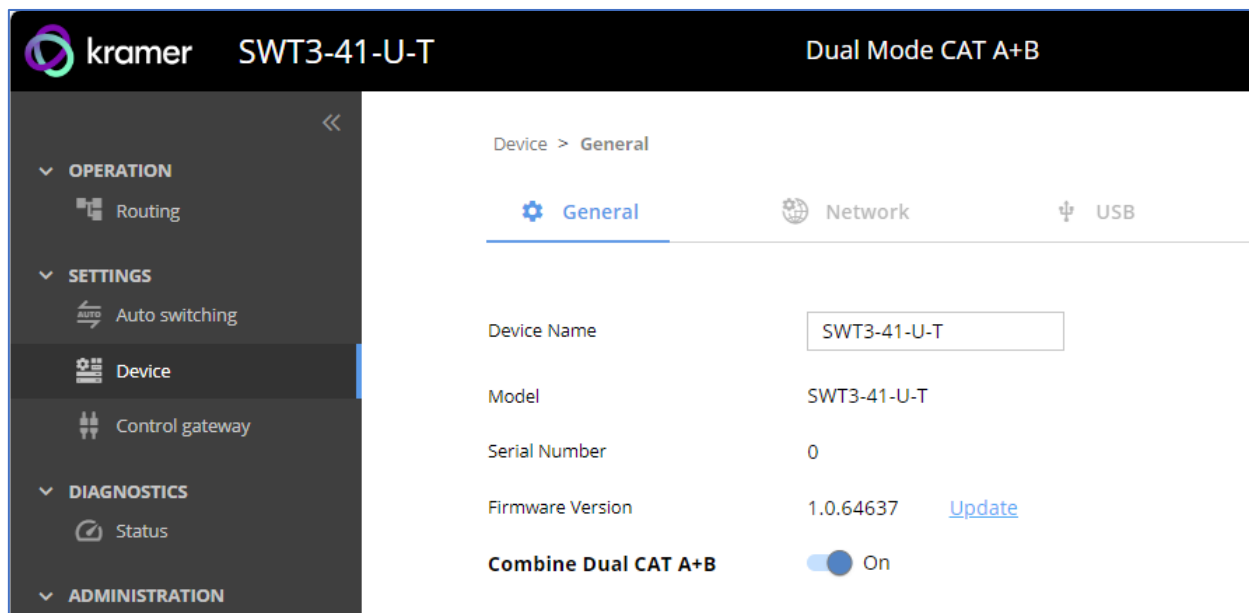

Figure 24: Device Settings > Dual Mode CAT A+B

Dual CAT A+B Mode is enabled.

## Resetting and Restarting Device

Two types of resets can be performed:

- **Restart** – Reboots your device and keeps all your device settings, including the IP address and password.
- **Reset** – Reboots your device and restores all factory settings including input/output definitions, switching configuration, IP address and password (a DHCP-acquired IP address is retained).

**To restart the device:**

- Click **DEVICE RESTART** on the **Device > General** page ([Figure 22](#)).

**To perform a factory reset on the device, use one of the following actions:**

- Click **FACTORY RESET** on the **Device > General** page ([Figure 22](#)).
- Using protocol 3000 commands, send FACTORY command then RESET commands.
- On the rear panel, press and hold the RESET button while connecting the power for several seconds.

## Exporting and Importing a Configuration File

**SWT3-41-U-T** enables you to export and store (in connected browsing PC storage) a configuration file, that records all current device settings except the routing operation setup. The stored file can then be imported to the same or different **SWT3-41-U-T** device to load the recorded settings, for configuration backup and/or solution-replication purposes.

## Exporting a Configuration File

To export a configuration file of the current device settings:

1. Go to the **Device > General** page ([Figure 22](#)).
2. Under Global System Settings, click **EXPORT**.
3. Select the storage location on your computer to save the configuration file and click **SAVE**.

The configuration file is exported and saved.

## Importing a Configuration File

To import a configuration file of the current device settings:

1. Go to the **Device > General** page ([Figure 22](#)).
2. Under Global System Settings, click **IMPORT**.
3. Select the relevant configuration file from your computer storage and click **SAVE**.

The configuration file is imported and the device restarts with the settings from the configuration file.

## Identifying Your Device

To identify the device using a supporting discovery system:

1. Go to the **Device > General** page ([Figure 22](#)).
2. Under Global System Settings, click **FLAG ME**. NET LED flashes.



FLAG ME indication turns off after 60 seconds.

The device is identified by the discovery system.

## Settings Networking Properties



By default, DHCP is set to on. The IP address shows the actual IP address acquired from the DHCP server, or the auto-acquired fallback IP address when there is no DHCP server detection.

To configure network settings:

1. Go to the **Device > General** page ([Figure 22](#)).
2. Select the **Network** tab.

The network page appears.

Setting	DHCP On	DHCP Off
DHCP	On	Off
MAC Address	00-1d-56-02-ee-c5	00-1d-56-02-ee-c5
IP Address	192.168.57.80	192.168.57.80
Mask Address	255.255.0.0	255.255.0.0
Gateway Address	192.168.0.254	192.168.0.254

Figure 25: Device Settings > Network Page (DHCP On/DHCP Off)

3. Change settings as needed.
  - If required, Set to **DHCP** (default) or static IP address resolution modes.
4. When in Static IP mode, perform the following actions:
  - Change the IP address.
  - Change the Mask address.
  - Change the Gateway address.
  - Define UDP/TCP port numbers.

Network settings are defined.

### Enabling/Disabling USB Ethernet Connection



USB-C ethernet connection is disabled by default and is enable only by command. (see [Protocol 3000 Commands](#) on page [65](#)).

## Auto-disconnecting a USB Device on Inactive Host

When a host becomes inactive, you can automatically disconnect one or multiple USB devices.

To define auto-disconnection:

1. Go to the **Device > General** page ([Figure 22](#)).
2. Select the USB tab.

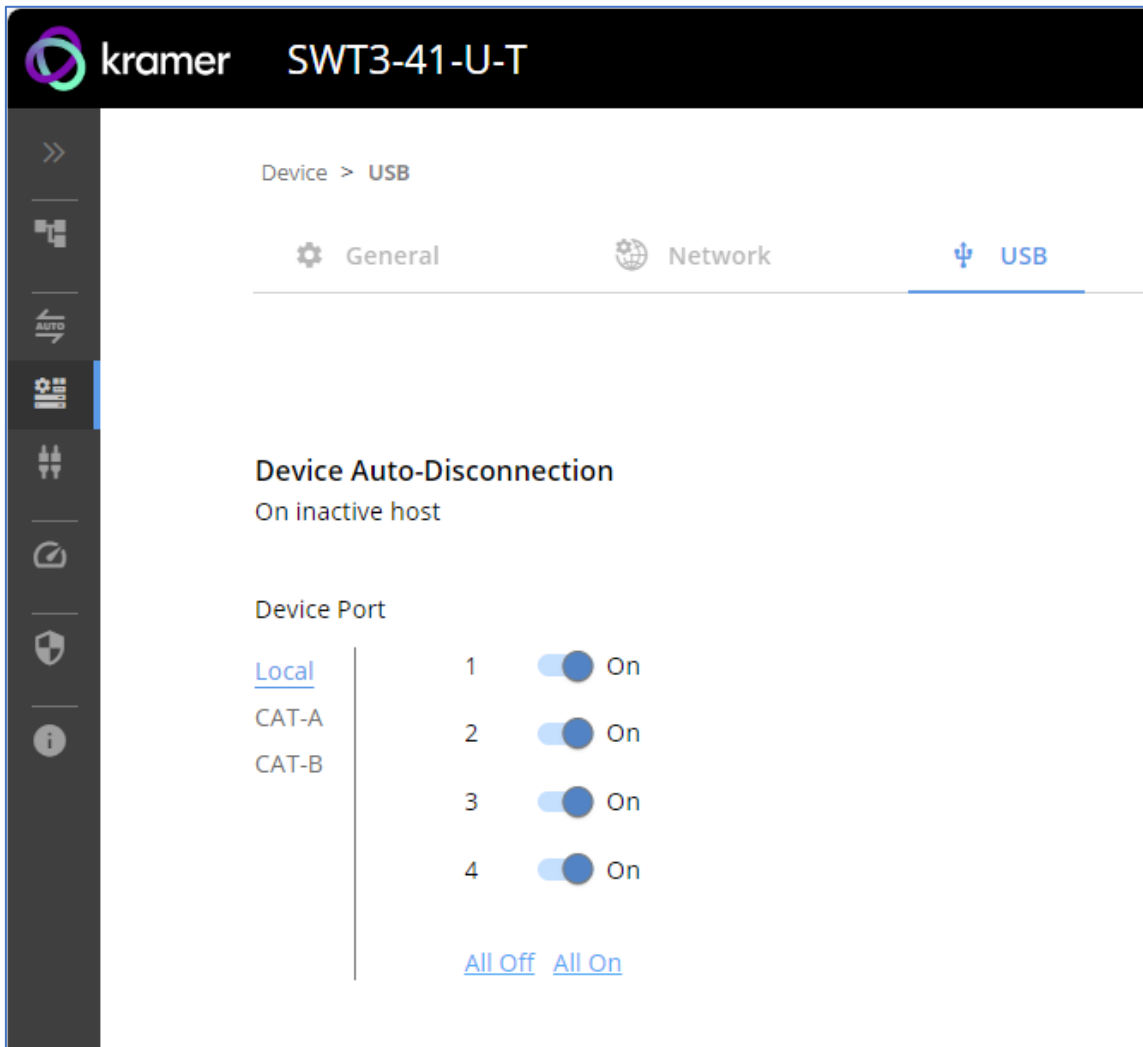

Figure 26: USB Page – USB Device Auto-Disconnection

3. For each USB Device Port, select the **Local** device ports on the **SWT3-41-U-T**; or select **CAT-A / CAT-B** for the devices located on the paired receivers.
  - set the auto disconnection status to **On** or **Off**. You can also Select **All Off** or **All On** to set all device ports to off or on, respectively.
4. Click **SAVE**.

USB devices are set for connected devices on local transmitter or remote receivers.

## Setting Time and Date

You can sync the device time and date to any server around the world.

### To sync device time and date to a server:

1. In the Navigation pane, click **Device**. The General tab in the Device page appears.
2. Select the **Time and Date** tab. The Time and Date tab appears.

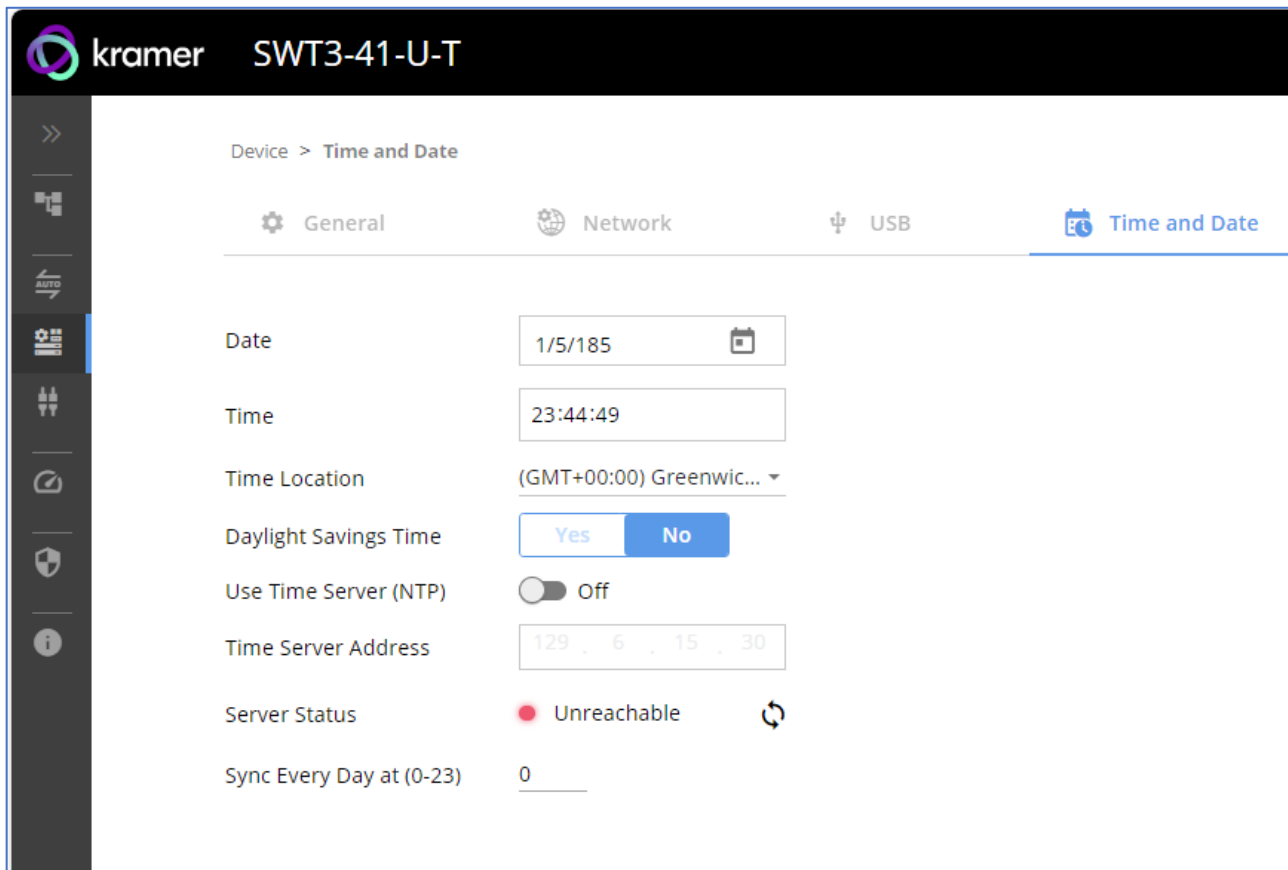

Figure 27: Device Settings – Time and Date Tab

3. Set the Date and Time.
4. Select the Time Location.
5. In the Use Time Server (NTP) drop-down box, click:
  - **Disabled** to disable the time server.
  - **Manual** to enable time server (NTP).
6. If enabled, type in server information:
  - Enter the time server address.
  - Set sync frequency (every 0 to 23 days).
7. Click **SAVE** for any change.

The devices date and time are synchronized to the server address entered.



## Control Gateway Properties

This section details the following actions:

- [Setting Serial Port Properties](#) on page [39](#).
- [Configuring Local I/O \(GPIO\) Ports](#) on page [43](#).
- [Configuring a Digital Output I/O Type](#) on page [44](#).
- [Configuring Remote Receiver I/O \(GPIO\) Ports](#) on page [46](#).
- [Defining and Testing Commands via Action Editor](#) on page [47](#).
- [Configuring Remote Buttons](#) on page [48](#).

### Setting Serial Port Properties

SWT3-41-U-T enables configuring the RS-232 port in one of the following ways:

- [Controlling the SWT3-41-U-T](#) on page [39](#).
- [Controlling a Local External Device](#) on page [40](#).
- [Extending Local RS-232 Port to Remote Receiver RS-232 Port](#) on page [41](#).
- [Controlling Remote Devices Connected to the Receiver](#) on page [42](#).

### Controlling the SWT3-41-U-T

To set the RS-232 port to control the device:

1. Go to the Control Gateway tab. The Serial Ports tab appears.

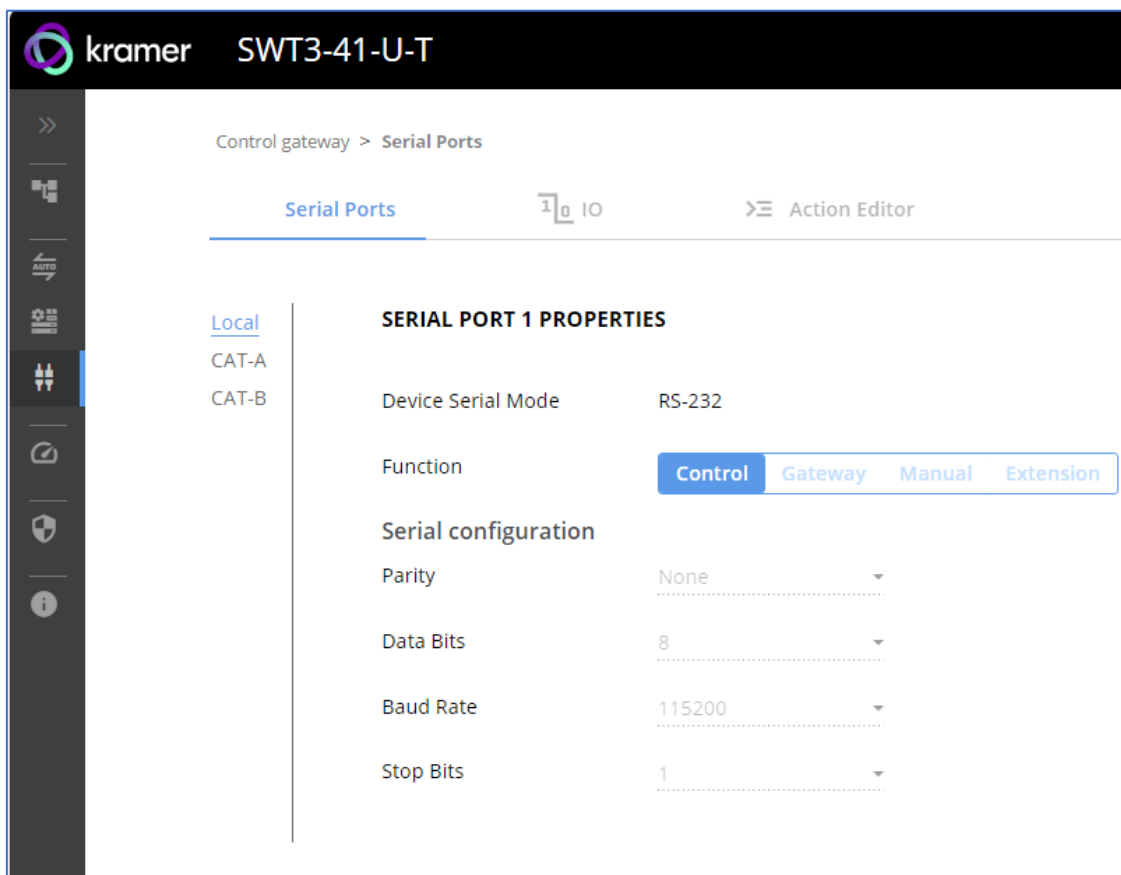

Figure 28: RS-232 for Device Control

2. Next to Function, select **Control**.
3. Click **SAVE**.

RS-232 port controls the **SWT3-41-U-T**.

### Controlling a Local External Device

Control a locally connected external device via an IP-connected Controller (for example **SL-240C** that is connected via LAN)

To set the **RS-232 port to control an external device:**

1. Go to the Control Gateway tab. The Serial Ports tab appears.
2. Next to Function, select **Gateway**.

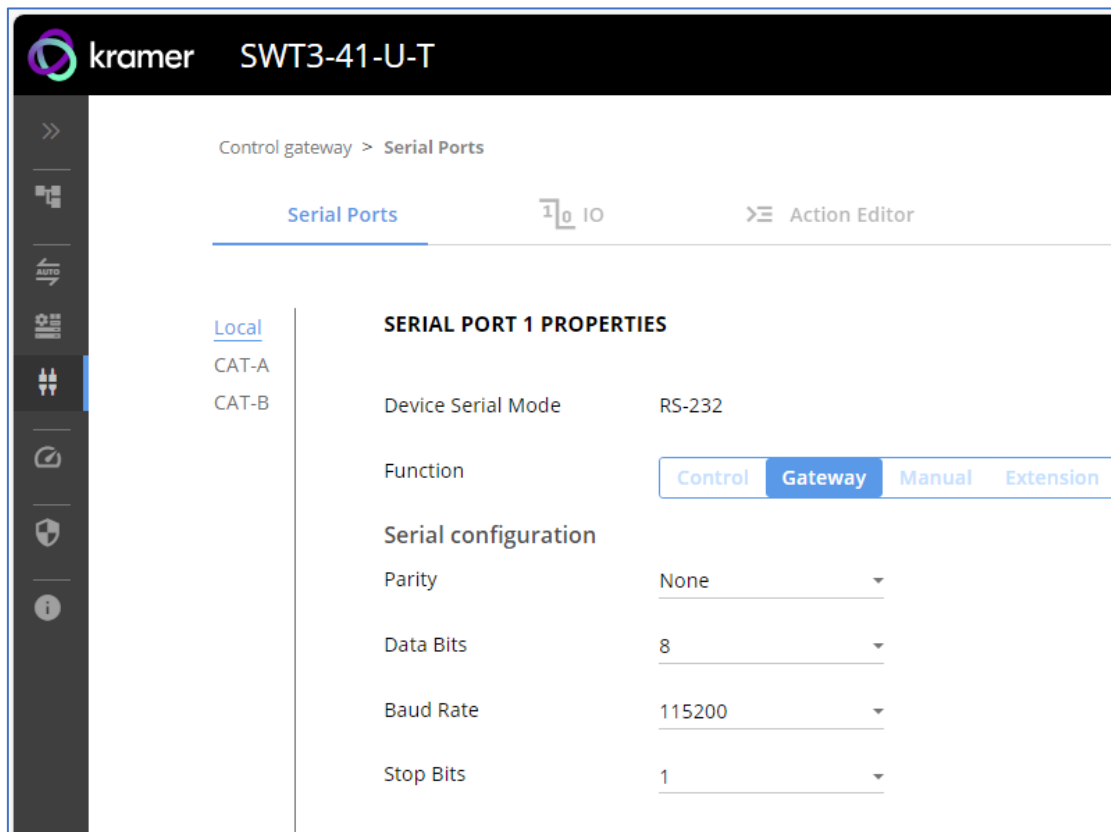

Figure 29: Gateway control of local RS-232 port

3. Define the external device RS-232 settings (Parity, Data Bits, Baud Rate and Stop Bits).
4. Click Save.

The Advanced Settings tab appears.

5. Select either UDP or TCP port.
6. Click **SAVE**.

RS-232 port controls locally connected external device via gateway.

## Extending Local RS-232 Port to Remote Receiver RS-232 Port

Enable RS-232 port extension over CAT link with bi-directional serial communication.

### To set the local RS-232 port extension to the receiver RS-232 port

1. Go to the Control Gateway page. The Serial Ports tab appears.
2. Next to Function, select **Extension**.

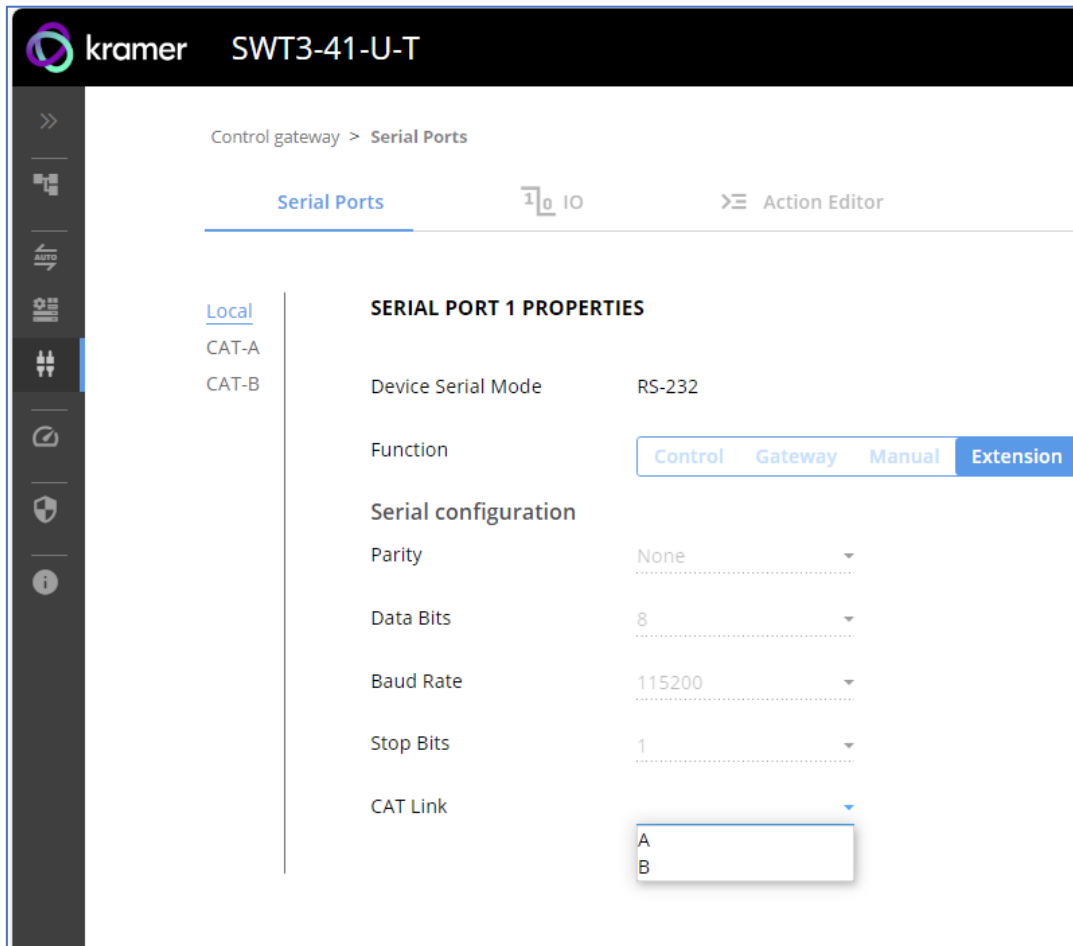

Figure 30: Local RS-232 port extension

3. Define the RS-232 communication settings (Parity, Data Bits, Baud Rate and Stop Bits).
4. Select link of paired receiver (CAT Link A / B).
5. Click **SAVE**.

RS-232 port extension with bi-directional communication is enabled.

## Controlling Remote Devices Connected to the Receiver

Control an external device, remotely connected to the receiver, via an IP-connected Controller to SWT3-41-U-T (for example **KC-VB1** that is connected via LAN).

**To set the receiver RS-232 port to control a connected external device:**

1. Go to the Control Gateway page. The Serial Ports tab appears.
2. In the left-hand side of the screen, select **CAT-A** or **CAT-B**.
3. Next to Function, select **Gateway**.

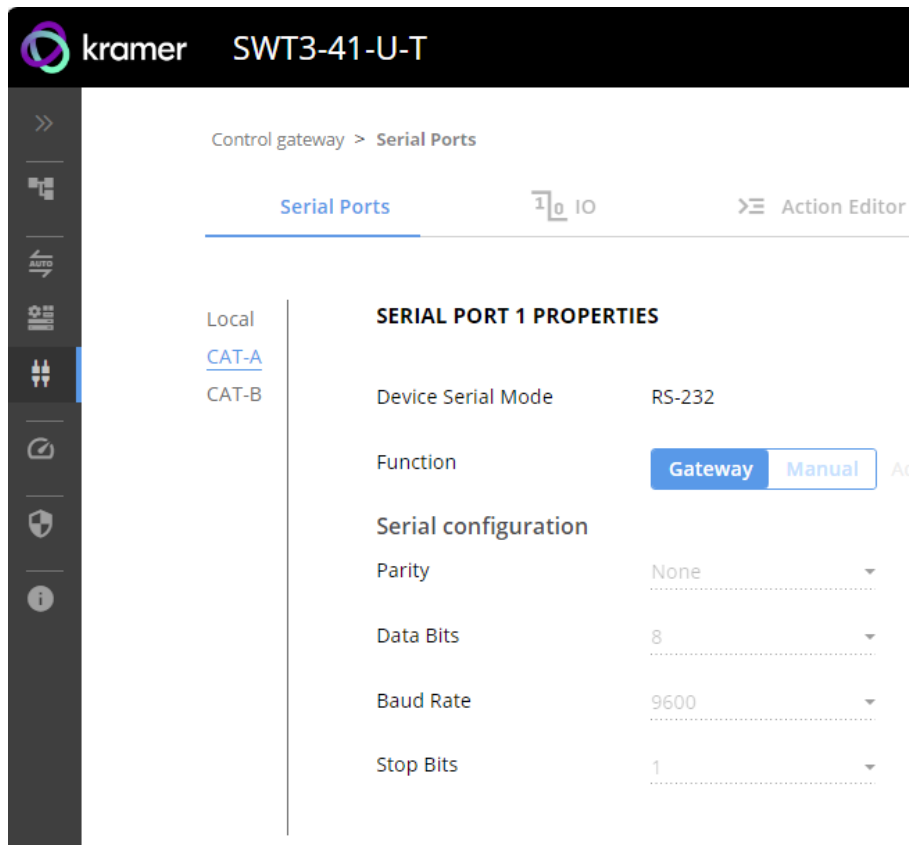

Figure 31: Gateway control of remote receiver RS-232 port

4. Define the paired-receiver RS-232 settings (Parity, Data Bits, Baud Rate and Stop Bits).
5. Click **SAVE**.

The TUNNELING ADVANCED PROPERTIES screen appears.

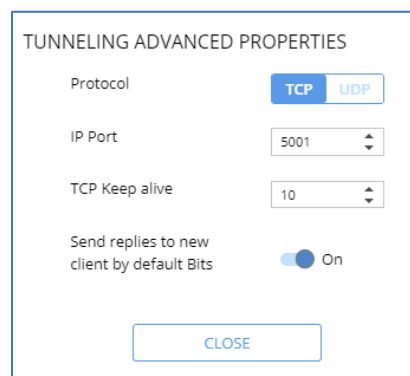

Figure 32: Setting Tunneling Advanced Properties

6. Select either TCP or UDP port.
7. Click up/down arrows to select IP Port for sending commands to RS-232.
8. Click up/down arrows to select desired seconds for TCP Keep alive.
9. Press to toggle ON Send replies to new clients by default Bits.
10. Click **CLOSE**.
11. Click **SAVE**.

RS-232 port controls via gateway a remote external device connected to the receiver RS-232 port.

## Configuring Local I/O (GPIO) Ports

The 2 local I/O ports can control devices such as sensors, door locks, remote contact-closure buttons, audio volume and lighting control devices and can be configured via the webpages.



To enable I/O operations, Remote Button must be set to Off.

### To configure an I/O port:

1. In the Navigation pane, click **Control Gateway**. The Serial Ports tab in the Device Settings page appears.
2. Select the IO tab. The IO tab appears.

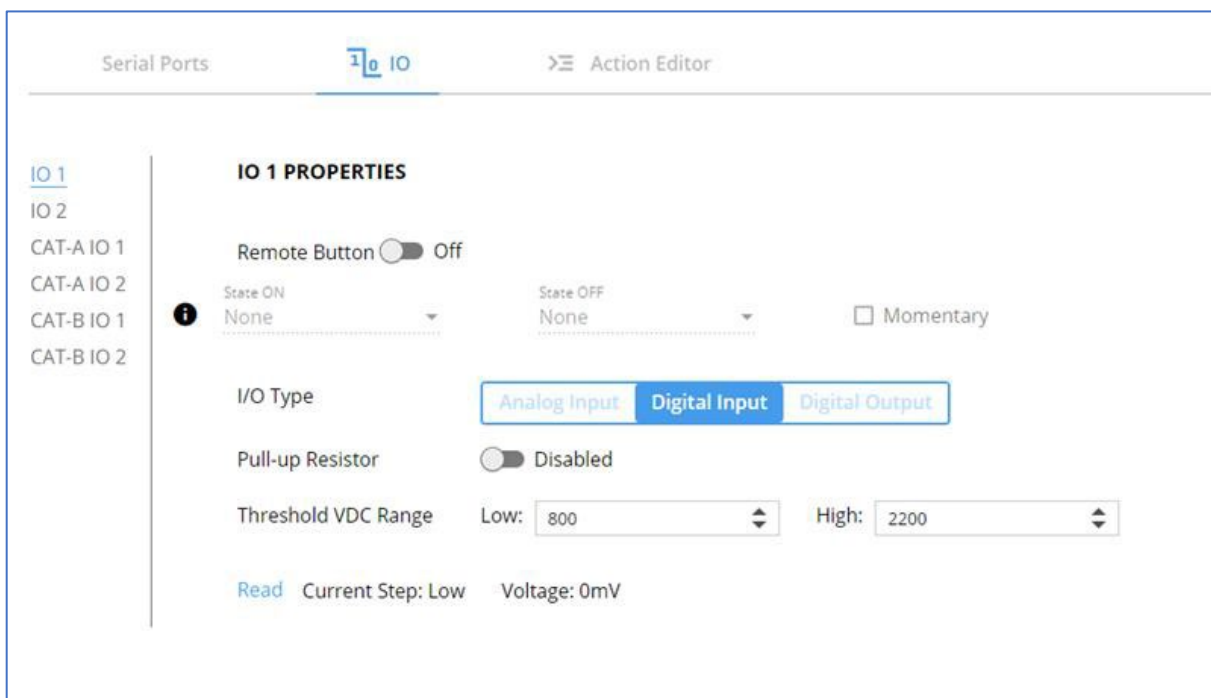

Figure 33: Local I/O ports settings tab – Digital Input Type

3. Select the local I/O port to be configured (IO 1 or IO 2).
4. Select one of the following I/O types:
  - **Digital Input (default setting)** (see [Configuring a Digital Input I/O Type](#) on page 44).

- **Digital Output** (see [Configuring a Digital Output I/O Type](#) on page 44).
- **Analog Input** (see [Configuring an Analog Input I/O Type](#) on page 45).



The settings available on the page change depending on which trigger type is selected.

5. Click **SAVE** after setting the selected I/O type.

### Configuring a Digital Input I/O Type

The Digital Input trigger mode reads the digital input of an external sensor device that is connected to the I/O port. It detects High (upon passing Max threshold from Low state) or Low (upon passing Min threshold from High state) port states according to the user defined voltage threshold levels.

#### To configure a digital input I/O type:

1. On the IO tab, select **Digital Input** next to I/O Type.  
The Digital Input options appear.
2. Select one of the following for the Pull-up resistor setting:
  - **Disabled**  
Suitable, for example, for a high temperature alarm that exceeds the maximum voltage threshold. When the pull-up resistor is disabled, the port state is low and to be triggered it must be pulled high by the externally connected sensor.
  - **Enabled** – Detection of an open circuit as High, or a short to ground as Low.  
This is suitable for example, for a pushbutton switch (connecting one terminal of the switch to ground, and the other to the input) or for an alarm closing a circuit that activates a series of actions. When the pull-up resistor is enabled, the port state is high, and to be triggered it must be pulled low by the externally connected sensor.
3. Set the Threshold VDC Low and High Range (threshold voltage at which the port changes state).
4. Click **Read** to refresh port status information.
5. Click **SAVE**.

Digital input I/O type is configured.

### Configuring a Digital Output I/O Type

#### To configure a digital output I/O type:

1. On the IO tab, select Digital Output next to I/O type.  
A warning message appears.

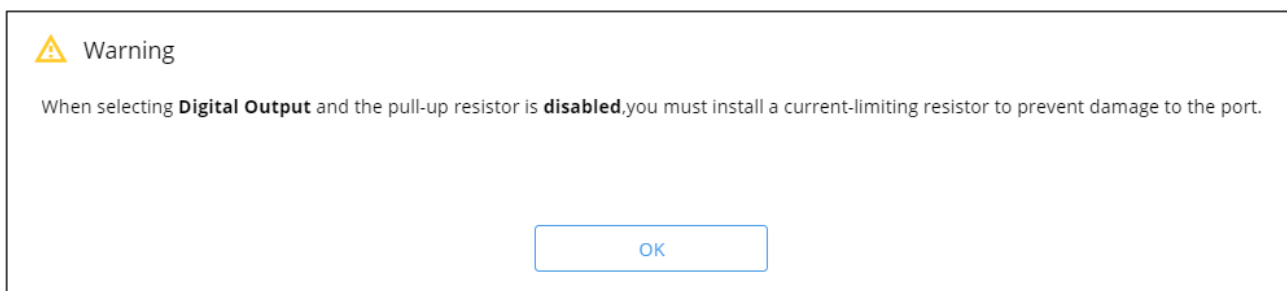

Figure 34: Digital Output Warning

2. Make sure to follow the instructions in this warning.
3. Click **OK**. The Digital Output options appear.

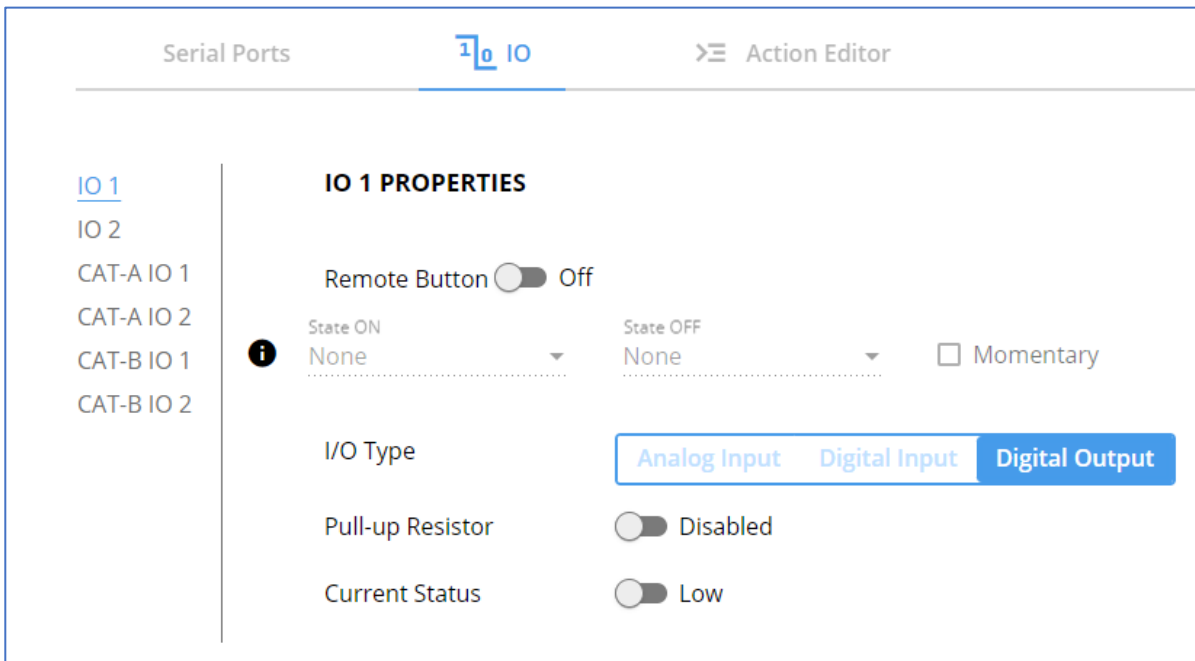



Figure 35: GPIO Settings Page – Digital Output I/O Type

4. Select one of the following for the Pull-up resistor setting:
  - **Pullup resistor set to Enabled:**  
The port can be used for controlling devices that accept a TTL signal such as for powering LEDs. The voltage output is TTL positive logic: high: >2.4V; low: < 0.5V. When the pull-up resistor is enabled, the port state is high. For the state to be low, you must select **Low** for the Current Status.
  - **Pullup resistor Disabled:**  
The port is used for controlling external devices such as room or light switches. The external source device determines the voltage output; the maximum voltage is 30V DC and the maximum current is 100mA. When the pull-up resistor is disabled, the port state is low. For the state to be high, select **High** for the Current Status.

 Make sure that the current in this configuration does not exceed 100mA.

5. Click **SAVE**.

Digital Output I/O type is configured.

### Configuring an Analog Input I/O Type

When selecting the Analog Input I/O type, the port is triggered by an external analog device, such as a volume control device. The trigger is activated once when the detected voltage is within the 0 to 30V DC voltage range.

### To configure an analog input I/O type:

1. On the I/O tab, select Analog Input next to I/O type.

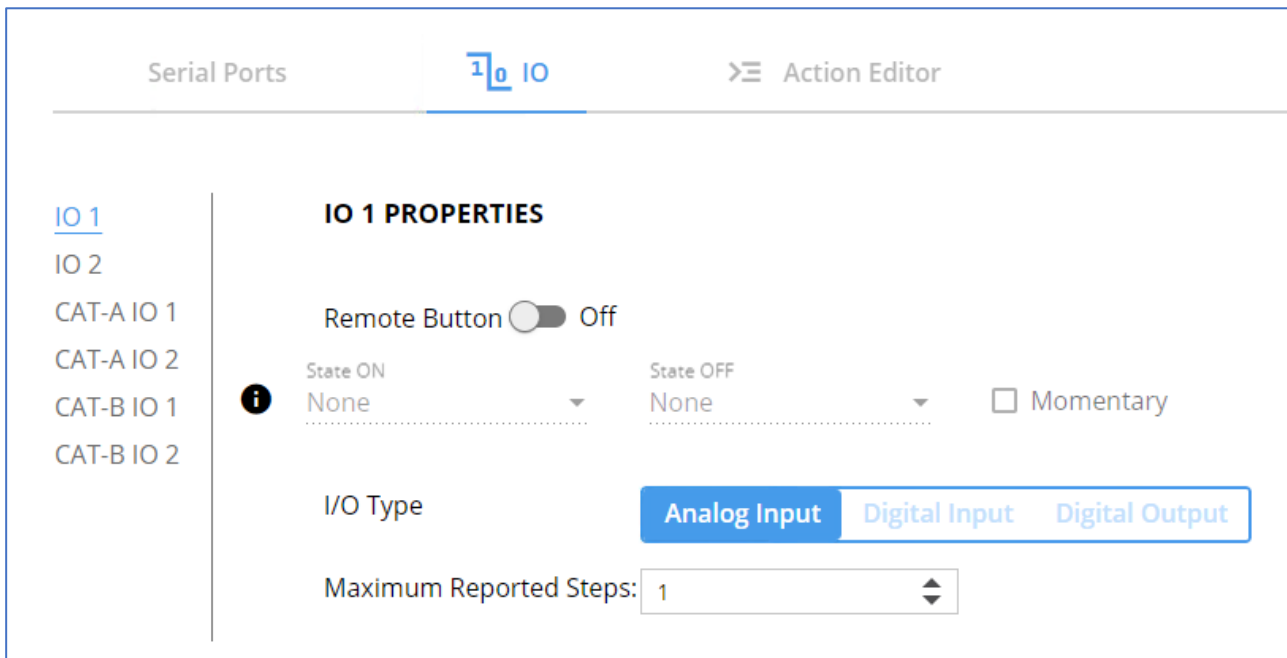

Figure 36: Local I/O ports settings tab - Analog Input Type

2. Enter or use the arrows to scroll to a value (1–100) for the Maximum reported steps. This value is the number of steps that the analog input signal is divided into. To calculate the voltage of each step, use the following formula:  
Voltage of one step = 30V / number of steps.
3. Click **SAVE**.

Analog input I/O type is configured.

### Configuring Remote Receiver I/O (GPIO) Ports

The 4 remote I/O ports, on the paired receivers, can control devices connected to a receiver, such as sensors, door locks and lighting control devices, and can be configured via SWT3-41-U-T webpages.

#### To configure an I/O port:

1. In the Navigation pane, click **Control Gateway**. The Serial Ports tab in the Device Settings page appears.



2. Select the IO tab. The IO tab appears.

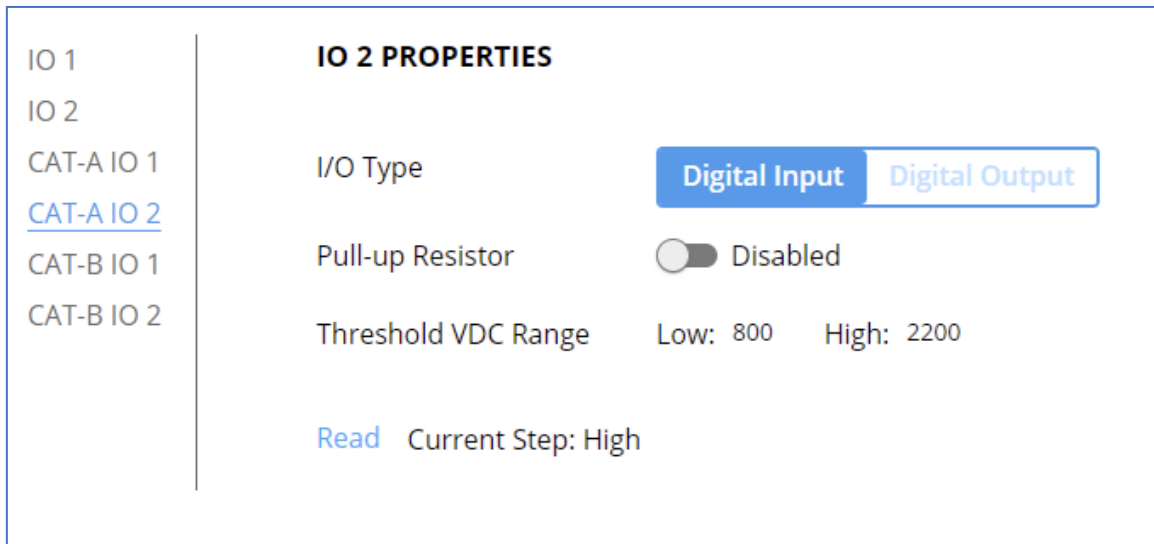

Figure 37: I/O Ports Settings Page

3. Select the CAT-A or CAT-B I/O port to be configured (IO 1 or IO 2).

4. Select one of the following I/O types:

- **Digital Input (default setting)** (see [Configuring a Digital Input I/O Type](#) on page 44).



- Remote buttons are not configurable on remote I/O ports.
- To Configure Remote buttons, refer to [Configuring Remote Buttons](#) on page 48.

- **Digital Output** (see [Configuring a Digital Output I/O Type](#) on page 44).

5. Click **SAVE** after setting the selected I/O type.

### Defining and Testing Commands via Action Editor

Use action editor to create and test control commands via RS-232 control interfaces. You can create up to 5 commands.

#### To add an action:

1. In the navigation pane, select **Control Gateway**. The Serial Ports tab opens.

2. Select the **Action Editor** tab. The Action Editor appears.

Control gateway > Action Editor

Serial Ports IO Action Editor

Command01  
Command01  
Command01  
Command01  
Custom Cmd 5

**ACTION PROPERTIES**

Command Id 0

Command Name Command01

Port

Command  
02,03,

444 characters left

Syntax (like CEC-SND command): <port\_num>, <cmd\_id>, <cmd\_name>, <len>, <cec\_command>

RUN COMMAND

Figure 38: Action Editor Tab

3. Select a command name on the left side of the window.
4. Change the command name, if required.
5. Select the port (UART).
6. Enter the appropriate command line (see example below) to have NET LED blink for 60 seconds:
  - For RS232 - 1,#IDV
7. Click **SAVE**.
8. Click **RUN COMMAND** to run the command test.

An action is entered and can be run.

### Configuring Remote Buttons

Remotely operate, by I/O-connected remote buttons, configured control actions (see (see [Defining and Testing Commands via Action Editor](#) on page 47).

#### To Configure Remote Buttons:

1. In the Navigation pane, click **Control Gateway**. The Serial Ports tab in the Device Settings page appears.
2. Select the IO tab. The IO tab appears.
3. Press to toggle **Remote Button** to On.
4. Configure defined control actions, for button on/off states, using the **State ON**, **State OFF** drop-down boxes.

- Button default operation mode is latching. For momentary mode, check the Momentary checkbox.

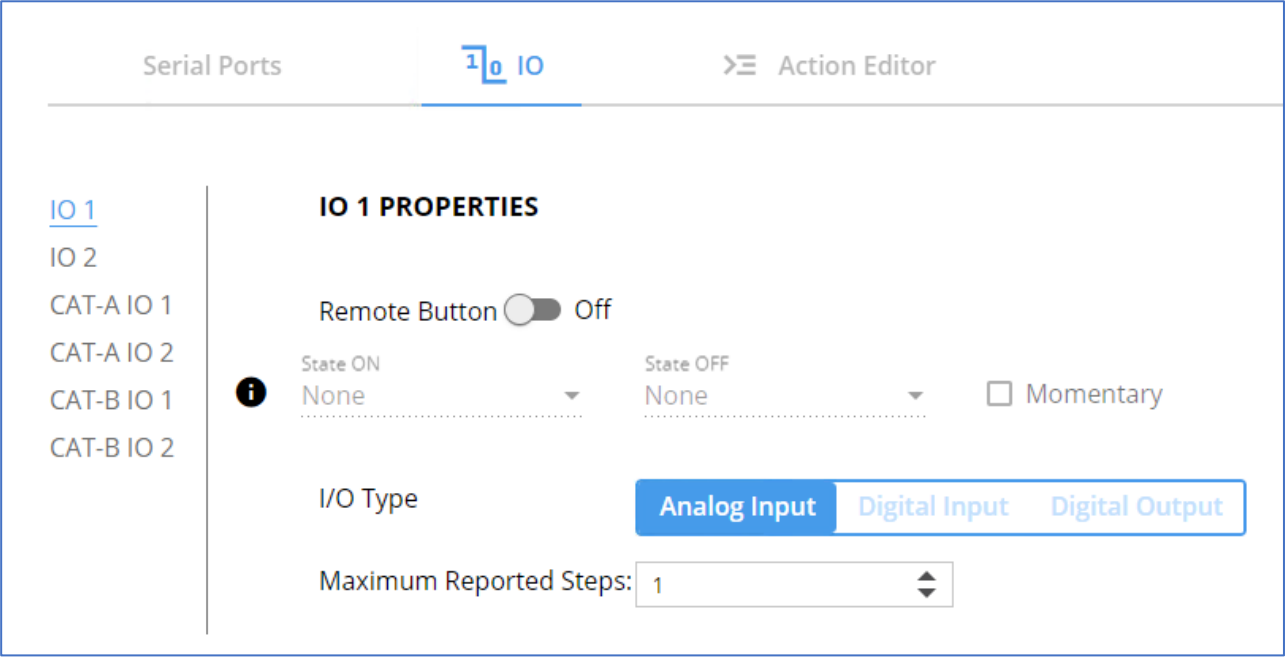

Figure 39: I/O ports settings tab – Configuring Remote Buttons

5. Click **SAVE**.

A control actions remote button can now be remotely operated.

## Diagnostics

### Viewing Device Status

View the device status.

To view the device status:

1. In the navigation pane, select **Status**.
2. Select the **Devices** tab. The Devices Status appears.

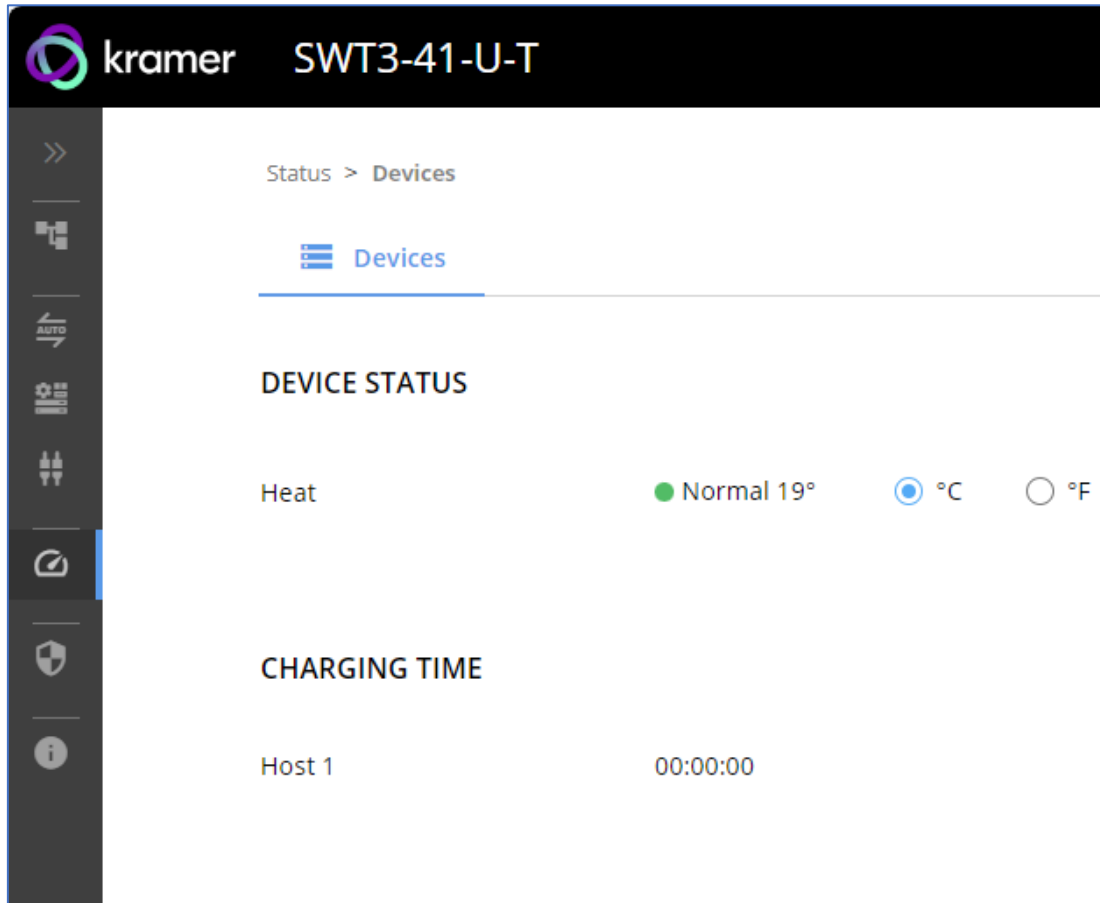

Figure 40: Device Status Page

3. View device status.

Device status can be viewed.

## Administration

### Setting Security Properties

This section details the following actions:

- [Changing Security Status](#) on page [51](#).
- [Defining 802.1X Authentication](#) on page [52](#).

## Changing Security Status

By default, security status is set to On.

### Setting Security Status to Off

To set security status to Off:

1. Go to the Security page ([Figure 41](#)).
2. Select the Security tab. The Security settings appears.

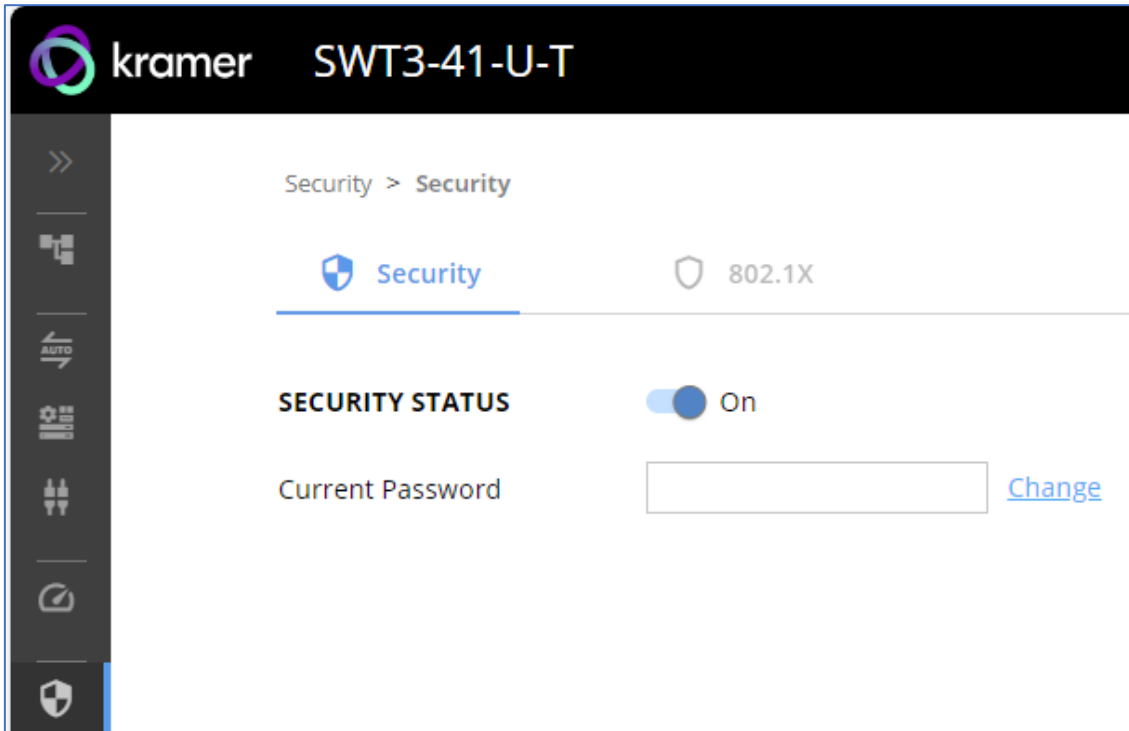

Figure 41: Security – Security Tab

3. Set **SECURITY STATUS** to **Off**. The Security Status window appears.

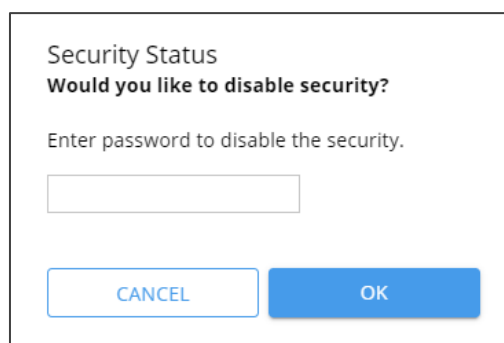

Figure 42: Security Status Message

4. Enter the current password.
5. Click **OK**.

Security status is set to Off.

## Setting Security Status to On

To set security status to on:

1. Go to the Security > Security ([Figure 41](#)).
2. Set SECURITY STATUS to **On**.

Security status is set to On.

## Changing Web Pages Access Password

To change the password for accessing the embedded web pages:

1. Go to the Security page ([Figure 22](#)).
2. Select the Security Tab. The Security settings appear ([Figure 43](#)).
3. Enter the Current Password and click **Change**. The new password settings appear.

The screenshot shows a web interface for security settings. At the top, 'SECURITY STATUS' is set to 'On' with a blue toggle switch. Below this, there are three input fields: 'Current Password' (containing five dots), 'New Password', and 'Confirm Password'. A blue 'Change' link is positioned to the right of the 'Current Password' field. At the bottom of the form, there are two buttons: 'CANCEL' and 'SAVE'.

Figure 43: Device Settings – Changing the Password

4. Enter the new password and confirmation password and click **SAVE**.

The password is changed.

## Defining 802.1X Authentication

802.1x security standard supports IT networking authentication based on LAN port and MAC address.

**To configure security:**

1. In the Navigation pane, click **Security**. The Security settings tab in the Security page appears.
2. Select **802.1X** tab. The 802.1X settings tab appears (see [Figure 44](#)).

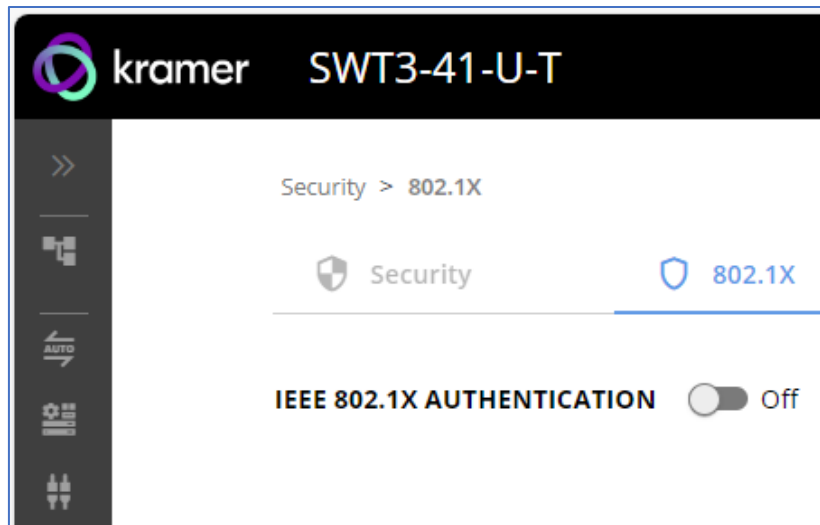

Figure 44: 802.1X Tab

3. For 802.1x authentication, click **ON** to enable 802.1x authentication service. 802.1x supports authentication based on port and MAC address.
4. When set to ON check one standard authentication method to set its security attributes.
  - **PEAP-MSCHAP V2** (Figure 45) – Enter:
    - Username - up to 24 alphanumeric characters, including “\_” and “-“ characters within the username, and
    - Password - up to 24 ASCII characters

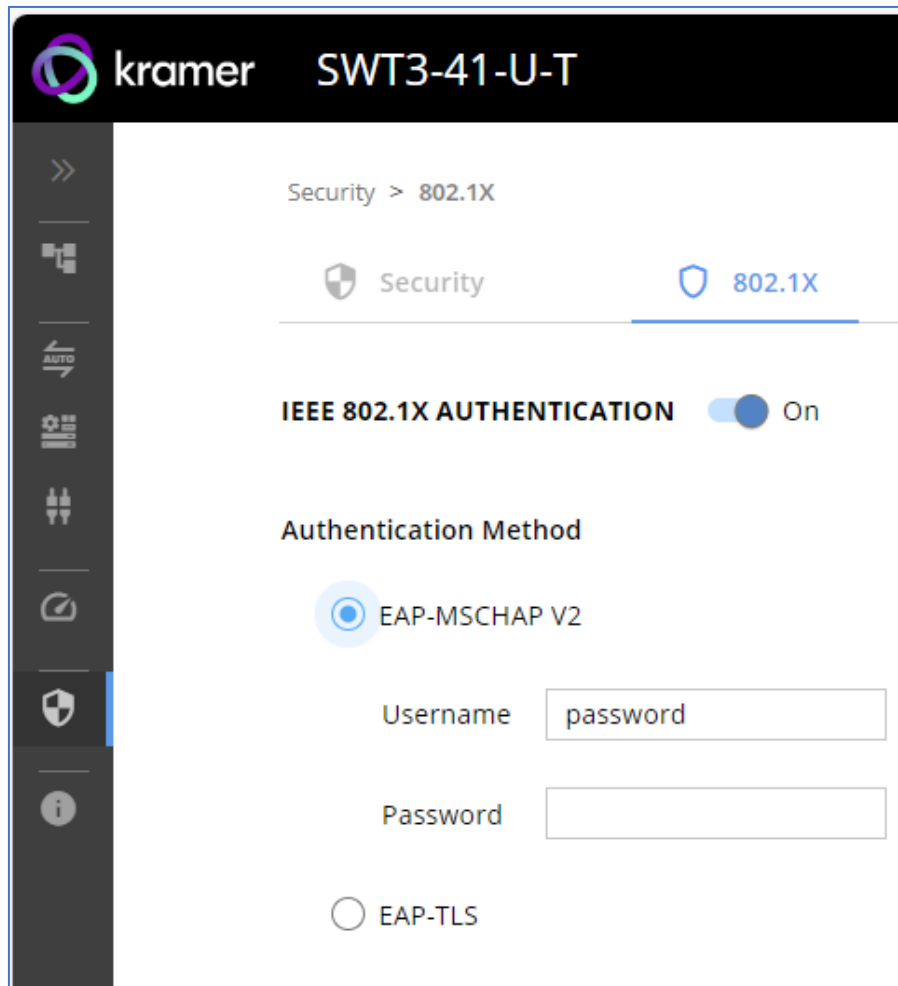



Figure 46: Security Tab – EAP-MSCHAP V2 Authentication

- **EAP-TLS** (Figure 47) – To submit certificate from the server for authentication:
  - Enter Username,
  - Click  to upload the certificates and keys,
  - Enter the private key password (assigned by IT administrator),
  - Set Server Certificate **On**



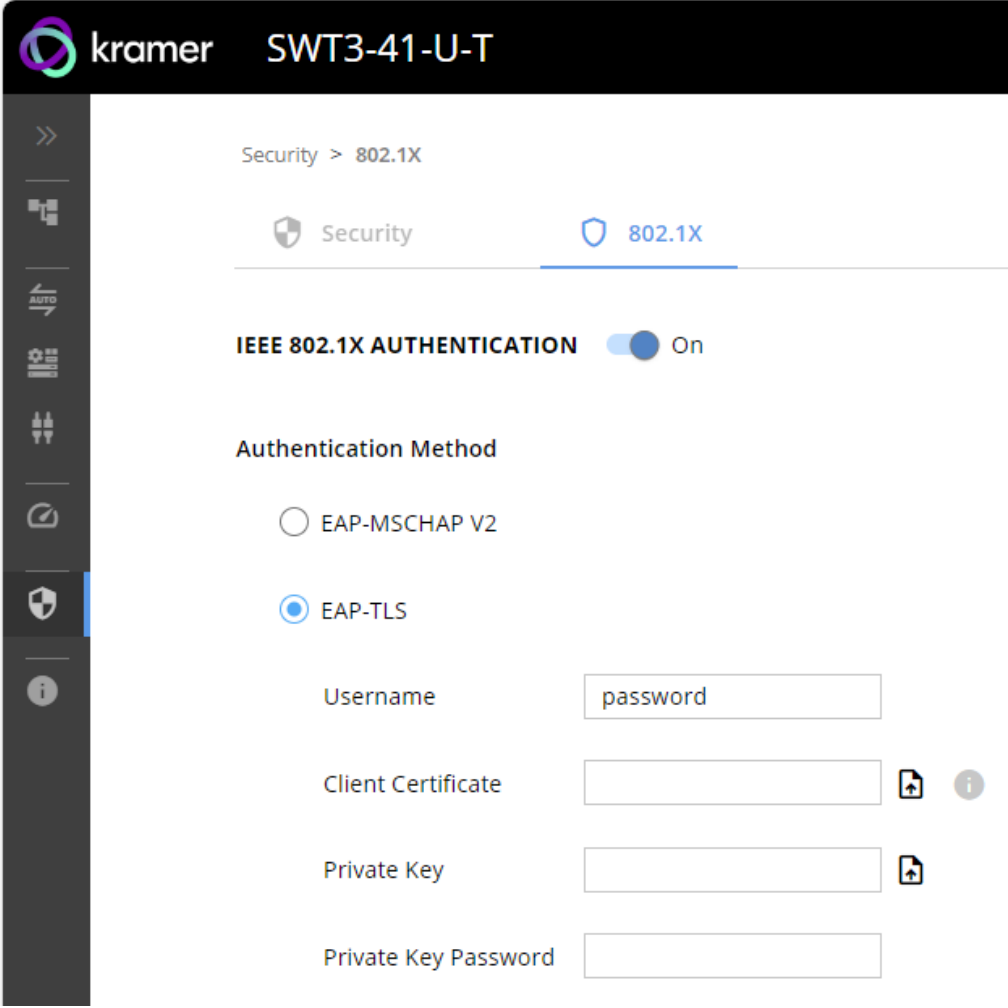

Figure 48: EAP-TLS – Certificates and Password

- 5. Click **APPLY**.  
802.1x authentication security is configured.

# Viewing the About Page

View the firmware version and Kramer Electronics Ltd details in the About page.

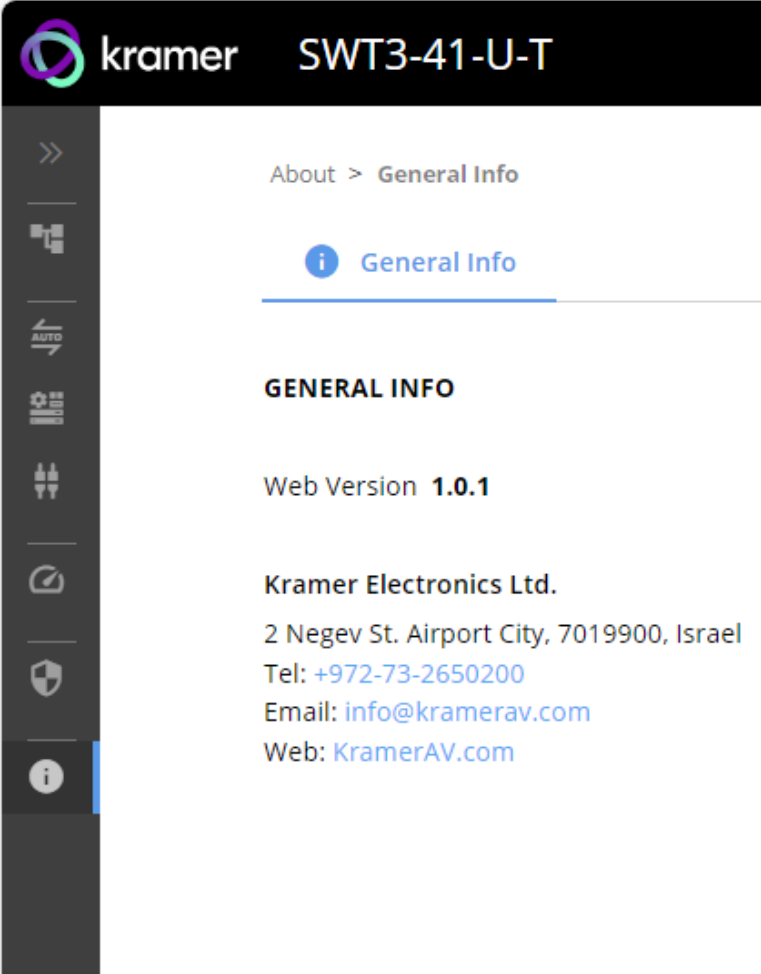

Figure 49: About Page

# Upgrading Firmware

Use the Kramer **K-UPLOAD** software to upgrade the firmware via ethernet or the RS-232 port, allowing RS-232 to control/program the device). The device continues to operate and once FW upload complete, you are asked to Restart no or later.



The latest version of **K-UPLOAD** and installation instructions can be downloaded from our website at: [www.kramerav.com/support/product\\_downloads.asp](http://www.kramerav.com/support/product_downloads.asp).



Note that in order to use the micro USB port, you need to install the Kramer USB driver, available at: [www.kramerav.com/support/product\\_downloads.asp](http://www.kramerav.com/support/product_downloads.asp).

# Technical Specifications

## SWT3-41-U-T

Hosts	2 USB 3.2 & PD 3.0		On USB type-C female connectors
	2 USB 3.2		On USB-B female connectors
Devices	3 USB 3.2		On USB-A female connectors
	1 USB 3.2		On USB type-C female connector
Ports	1 Stereo Analog Balanced Audio		On 5-pin terminal block for audio extension
	2 CAT		On RJ-45 female connector for extension line
	1 PoE-accepting Ethernet		On an RJ-45 female connector for LAN connection and extension over CAT links
	1 RS-232		On 3-pin terminal block
	2 GPIO		On 2-pin terminal block
USB Features	Integrated USB Hubs		2 [device 1 & 2 ports] or 1 [other device ports]
	Standards Compliance		USB 3.2 GEN 2, 2.0 and 1.1
Extended USB	Data Rate		Up to 480Mbps
	Transmitted Data Bandwidth		Up to 300Mbps
	Standards Compliance		2.0 and 1.1 USB
Controls	Front Panel		Input selector buttons, A+B CAT, Net and Status LED indicators.
Extension Line	Reach		Up to 100m (330ft) when using Kramer cables
Extended Ethernet	Data Rate		Up to 100Mbps
Extended RS-232	Baud Rate		9600
Power	Included Power Adapter  For HW Rev 02 and higher, 20V PSU (power supply unit) is included (replacing the 12V PSU).		20V DC: 6A
			Consumption: 3.8A
			Max. Power: 80W
	Optional Power Adapter		12V DC: 2A
			Consumption: 1.2A
			Max. Power: 15W
	PoE	Consumption	370mA
		Max. Power	20W
	USB-C Host Charging	Max. Power	60W  When powered with 20V power supply only
		Compliance	PD 3.0
USB Device Charging	Max. Total Current	2A	
Environmental Conditions	Operating Temperature		0° to +40°C (32° to 104°F)
	Storage Temperature		-40° to +70°C (-40° to 158°F)
	Humidity		10% to 90%, RHL non-condensing
Regulatory Compliance	Safety		CE, FCC, UKCA
	Environmental		RoHs, WEEE

Enclosure	Size	0.5 1U rack
	Type	Aluminum
	Cooling	Fan Ventilation
General	Net Dimensions (W, D, H)	21.46cm x 16.3 cm x 4.36cm (8.45" x 6.4" x 1.7")
	Shipping Dimensions (W, D, H)	35cm x 21cm x 6.8 cm (13.77" x 8.26" x 2.67")
	Net Weight	0.847 kg (0.84lbs)
	Shipping Weight	1.395 kg (3.075lbs)
Accessories	20V DC: 6A power supply and cord, USB-C multi-signal cable	
Specifications are subject to change without notice at <a href="http://www.kramerav.com">www.kramerav.com</a>		

## EXT3-UE-R

Ports	1 CAT	On RJ-45 female connector for extension line	
	1 Stereo Analog Balanced Audio	On 5-pin terminal block for audio extension	
	3 USB 2.0 Devices	On USB-A female connector	
	1 USB 2.0 Devices	On a USB-C female connector	
	1 PoE-accepting Ethernet	On RJ-45 female connector for LAN connection and extension over CAT link	
	1 RS-232	On 3-pin terminal block	
	2 GPIO	On 2-pin terminal block	
Extension Line	Reach	Up to 100m (330ft) when using Kramer cables	
Extended USB	Data Rate	Up to 480Mbps	
	Integrated USB Hubs	1	
	Transmitted Data Bandwidth	Up to 300Mbps	
	Standards Compliance	2.0 and 1.1 USB	
Controls	Front Panel	Link and ON Status LED indicators.	
Extended Ethernet	Data Rate	Up to 100Mbps	
Extended RS-232	Baud Rate	9600	
Power	Power adaptor	Source	12V DC/2A (not included)
		Consumption	1.1A
		Max. Power	12W
	PoC	Consumption	0.15A
		Max. Power	3W
	USB Device Charging	Max. Total Current	2A  When device is PoC-powered via HDBT, total USB devices charging current is 0.5A only. Workaround: Power device via either LAN PoE or optional power supply to increase total charging current.
Environmental Conditions	Operating Temperature	0° to +40°C (32° to 104°F)	
	Storage Temperature	-40° to +70°C (-40° to 158°F)	
	Humidity	10% to 90%, RHL non-condensing	
Regulatory Compliance	Safety	CE, FCC, UKCA	
	Environmental	RoHs, WEEE	

General	Size	Tool
	Type	Aluminum
	Cooling	Passive
	Net Dimensions (W, D, H)	12.3cm x 6.95cm x 2.74cm (4.84" x 2.73" x 0.37")
	Shipping Dimensions (W, D, H)	15.7cm X 12cm X 8.7cm (6.18" x 4.72" x 3.42")
	Net Weight	0.242kg (0.53lbs)
	Shipping Weight	0.963kg (2.21lbs)
Accessories	None	
Specifications are subject to change without notice at <a href="http://www.kramerav.com">www.kramerav.com</a>		

## EXT3-U-R

Ports	1 CAT	On an RJ-45 female connector for extension line
	1 Stereo Analog Unbalanced Audio	On a 3.5mm mini jack for audio extension
	4 USB	On USB-A female connector for USB devices extension
	1 RS-232	On a 3-pin terminal block for serial link extension
Extended USB	Data Rate	Up to 480Mbps
	Transmitted Data Bandwidth	Up to 300Mbps
	Standards Compliance	1.1 and 2.0 USB
Extension Line	Reach	CAT 6A: Up to 100m (330ft) CAT 5e: Up to 30m (100ft) When using Kramer cables
Extended RS-232	Baud Rate	9600
USB Charging	Max Total Current	PSU-powered: 2.5A PoC-powered: 0.5A
	Max Current Per Port	PSU-powered: 2A PoC-powered: 0.5A
Indication LEDs	Front Panel	LINK LED and ON LED
Power	Consumption	12V DC, 1500mA
	Source	12V DC, 2A
Specifications are subject to change without notice at <a href="http://www.kramerav.com">www.kramerav.com</a>		

## ACC3-12-SP

Ports	1 CAT	On RJ-45 female connector
	2 CAT	On RJ-45 female connector for extension line
Environmental Conditions	Operating Temperature	0° to +40°C (32° to 104°F)
	Storage Temperature	-40° to +70°C (-40° to 158°F)
	Humidity	10% to 90%, RHL non-condensing
Regulatory Compliance	Safety	CE, FCC, UKCA
	Environmental	RoHs, WEEE
Enclosure	Size	Pico Tools
	Type	Aluminum
	Cooling	None
General	Net Dimensions (W, D, H)	6.22cm x 5.18 cm x 2.44cm (8.45" x 6.4" x 1.7")
	Shipping Dimensions (W, D, H)	49cm x 18.6 cm x 58.8cm (19" x 7.32" x 23.14")
	Net Weight	0.104 (0.22lbs)
	Shipping Weight	0.214 kg (0.47lbs)
Accessories	None	
Specifications are subject to change without notice at <a href="http://www.kramerav.com">www.kramerav.com</a>		



## Default Communication Parameters

RS-232	
Baud Rate:	115,200
Data Bits:	8
Stop Bits:	1
Parity:	None
Command Format:	ASCII
Example (Route video input 2 to the output):	#ROUTE_1,1,2<CR>
IP DHCP ON	
To reset the IP settings to the factory reset values go to: Menu->Setup -> Factory Reset-> press Enter to confirm	
Fallback IP Address:	192.168.1.39
Fallback Subnet mask:	255.255.255.0
Fallback gateway:	192.168.0.1
Default username:	Admin
Default password:	Admin
Full Factory Reset	
P3K	<p>"#FACTORY" command.</p> <p>After receiving "FACTORY OK" perform one of the following to restart the device and complete the procedure:</p> <ul style="list-style-type: none"> <li>• Power cycle</li> <li>• Send command "#RESET"</li> </ul>
Embedded webpages	Go to: Device>General and click FACTORY RESET

# Protocol 3000

Kramer devices can be operated using Kramer Protocol 3000 commands sent via serial or Ethernet ports.

## Understanding Protocol 3000

Protocol 3000 commands are a sequence of ASCII letters, structured according to the following.

- **Command format:**

Prefix	Command Name	Constant (Space)	Parameter(s)	Suffix
#	Command	_	Parameter	<CR>

- **Feedback format:**

Prefix	Device ID	Constant	Command Name	Parameter(s)	Suffix
~	nn	@	Command	Parameter	<CR><LF>

- **Command parameters** – Multiple parameters must be separated by a comma (,). In addition, multiple parameters can be grouped as a single parameter using brackets ([ and ]).
- **Command chain separator character** – Multiple commands can be chained in the same string. Each command is delimited by a pipe character (|).
- **Parameters attributes** – Parameters may contain multiple attributes. Attributes are indicated with pointy brackets (<...>) and must be separated by a period (.).

The command framing varies according to how you interface with **SWT3-41-U-T**. The following figure displays how the # command is framed using terminal communication software (such as Hercules):

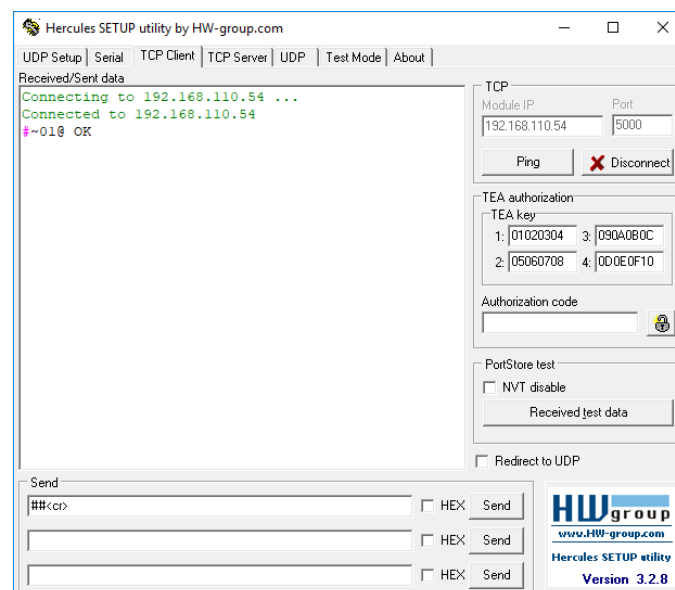

# Protocol 3000 Commands

Function	Description	Syntax	Parameters/Attributes	Example
#	Protocol handshaking.  ① Validates the Protocol 3000 connection and gets the machine number.  Step-in master products use this command to identify the availability of a device.	<b>COMMAND</b> #<CR> <b>FEEDBACK</b> ~nn@_ok<CR><LF>		#<CR>
AUD-MUTE	Set audio mute.	<b>COMMAND</b> #AUD-MUTE_out_index,mute_mode<CR> <b>FEEDBACK</b> ~nn@AUD-MUTE_out_index,mute_mode<CR><LF>	out_index -1 mute_mode - On/Off 0 - Off 1 - On	Set Output 1 to mute: #AUD-MUTE_1,1<CR>
AUD-MUTE?	Set audio mute.	<b>COMMAND</b> #AUD-MUTE_out_index<CR> <b>FEEDBACK</b> ~nn@AUD-MUTE_out_index,mute_mode<CR><LF>	out_index -1 mute_mode - On/Off 0 - Off 1 - On	Get Output 1 to mute: #AUD-MUTE_1,1<CR>
AUTH-802-1X-ENABLE	Set authentication 802.1X feature for the specific interface.	<b>COMMAND</b> #AUTH-802-1X-ENABLE_interface,enable_status<CR> <b>FEEDBACK</b> ~nn@AUTH-802-1X-ENABLE_interface,enable_status<CR><LF>	interface - Interface ID - 0 enable_status - 0 - Off 1 - On	Set the authentication 802.1X feature on: #AUTH-802-1X-ENABLE_0,1<CR>
AUTH-802-1X-ENABLE?	Get authentication 802.1X feature for the specific interface.	<b>COMMAND</b> #AUTH-802-1X-ENABLE?_interface<CR> <b>FEEDBACK</b> ~nn@AUTH-802-1X-ENABLE_interface,enable_status<CR><LF>	interface - Interface ID - 0 enable_status - 0 - Off 1 - On	Get the authentication 802.1X feature status: #AUTH-802-1X-ENABLE?_0<CR>
AUTH-802-1X-ENABLE?	Get Authentication 802.1X operational status.	<b>COMMAND</b> #AUTH-802-1X-OP-STAT?_interface<CR> <b>FEEDBACK</b> ~nn@AUTH-802-1X-OP-STAT_interface, status<CR>	interface - Index for ethernet interface number. - 0 enable_status - 0 - Running 1 - Not Running	Get the authentication 802.1X operational status: #AUTH-802-1X-OP-STAT?_0<CR>
AUTH-802-1X-OP-STAT?	Get Authentication 802.1X operational status.	<b>COMMAND</b> #AUTH-802-1X-OP-STAT?_interface<CR> <b>FEEDBACK</b> ~nn@AUTH-802-1X-OP-STAT_interface<CR>	interface - Interface ID - 0 enable_status - 0 - Running 1 - Not Running	Get the authentication 802.1X operational status: #AUTH-802-1X-OP-STAT?_0<CR>
AV-SW-MODE	Set input auto switch mode (per output).	<b>COMMAND</b> #AV-SW-MODE_layer_type,out_index,connection_mode<CR> <b>FEEDBACK</b> ~nn@AV-SW-MODE_layer_type,out_index,connection_mode<CR><LF>	layer_type - Number that indicates the signal type: 1 - Video 2 - Audio out_index - 1 connection_mode - Connection mode 0 - manual 1 - priority switch 2 - last connected switch	Set the input audio switch mode to Manual for HDMI OUT: #AV-SW-MODE_1,1,0<CR>
AV-SW-MODE?	Get input auto switch mode (per output).	<b>COMMAND</b> #AV-SW-MODE?_layer_type,out_index<CR> <b>FEEDBACK</b> ~nn@AV-SW-MODE_layer_type,out_index,connection_mode<CR><LF>	layer_type - Number that indicates the signal type: 1 - Video 2 - Audio out_index - 1 connection_mode - Connection mode 0 - manual 1 - priority switch 2 - last connected switch	Get the input audio switch mode for HDMI OUT: #AV-SW-MODE?_1,1<CR>
BEACON-INFO?	Get beacon information, including IP address, UDP control port, TCP control port, MAC address, model, name.	<b>COMMAND</b> #BEACON-INFO?_<CR> <b>FEEDBACK</b> ~nn@BEACON-INFO_port_id,ip_string,udp_port,tcp_port,mac_address,model,name<CR><LF>	port_id - ID of the Ethernet port ip_string - Dot-separated representation of the IP address udp_port - UDP control port tcp_port - TCP control port mac_address - Dash-separated mac address model - Device model name - Device name	Get beacon information: #BEACON-INFO?_<CR>
BUILD-DATE?	Get device build date.	<b>COMMAND</b> #BUILD-DATE?_<CR> <b>FEEDBACK</b> ~nn@BUILD-DATE_date,time<CR><LF>	date - Format: YYYY/MM/DD where YYYY = Year MM = Month DD = Day time - Format: hh:mm:ss where hh = hours mm = minutes ss = seconds	Get the device build date: #BUILD-DATE?<CR>
CAT-LINK-DUAL?	Gets Dual Link Mode status	<b>COMMAND</b> #CAT-LINK-DUAL?_port_id<CR> <b>FEEDBACK</b> ~nn@CAT-LINK-DUAL?_port_id, status <CR>	port_id - CAT port to check if dual link is activated. 1 - CAT port A 2 - CAT port B status - 0 - disable (not activated) 1 - enable (activated)	Get the Dual Link Mode status: #CAT-LINK-DUAL_1<CR>  ① port_id: 1 (currently, the only available port)

Function	Description	Syntax	Parameters/Attributes	Example
CONF-EXPORT	Export configuration file	<b>COMMAND</b> #CONF-EXPORT _file_name<CR> <b>FEEDBACK</b> ~nn@CONF-EXPORT _file_name<CR><LF>		Export configuration file: #CONF-EXPORT _file_name<CR>
CONF-IMPORT	Export configuration file	<b>COMMAND</b> #CONF-IMPORT _file_name<CR> <b>FEEDBACK</b> ~nn@CONF-IMPORT _file_name<CR><LF>	file_name - the name of the file we want to upload for the import.	Import configuration file: #CONF-IMPORT _file_name<CR> 41-U-T-conf<CR>
COM-ROUTE?	Get tunneling port routing.  ⓘ This command sets tunneling port routing. Every com port can send or receive data from the ETH port.  Set command can edit an existing configuration.	<b>COMMAND</b> #COM-ROUTE? _com_id<CR> <b>FEEDBACK</b> ~nn@COM-ROUTE? _com_id, port_type, port_id, eth_rep_en, ping_val<CR><LF>	com_id - Machine dependent, * (get all route tunnels) port_type - TCP/UDP 0 - TCP 1 - UDP port_id - TCP/UDP port number eth_rep_en - Ethernet Reply 0 - COM port does not send replies to new clients 1 - COM port sends replies to new clients. ping_val - Send an empty string to TCP client every 0 to 3600 seconds. 0 - 3600	Get tunneling port routing for all route tunnels: #COM-ROUTE? _com_id<CR>
COUNTER?	Get the sent or received CEC messages count.	<b>COMMAND</b> #COUNTER? _category_id, sub_category_id<CR> <b>FEEDBACK</b> ~nn@COUNTER? _category_id, sub_category_id, count<CR><LF>	category_id - CEC messages: 0 Sub_category_id - Type of message: 0 - Sent message 1 - Received message count - Number range: 0-65535	Get the number of sent messages: #COUNTER? _category_id, sub_category_id, count<CR>
COUNTER-CLR	Clear CEC messages.	<b>COMMAND</b> #COUNTER-CLR? _category_id, sub_category_id<CR> <b>FEEDBACK</b> ~nn@COUNTER-CLR? _category_id, sub_category_id, count<CR><LF>	category_id - CEC messages: 0 Sub_category_id - Type of message to clear: 0 - Clear sent messages 1 - Clear received messages * - Clear all CEC messages	Clear all CEC messages: #COUNTER-CLR? _category_id, sub_category_id, count<CR>
DEV-STATE?	Get the device state.	<b>COMMAND</b> #DEV-STATE? _dev_state<CR> <b>FEEDBACK</b> ~nn@DEV-STATE? _dev_state<CR><LF>	dev_state - device state 0 - Active 1 - Power-on and no connected AV I/O ports (detecting cable connection faults) 2 - Power-on and standby (low power; cables are either connected or not)	Get device status: #DEV-STATE? _dev_state<CR>
ETH-PORT	Set Ethernet port protocol.  ⓘ If the port number you enter is already in use, an error is returned. The port number must be within the following range: 0-(2 <sup>16</sup> -1).	<b>COMMAND</b> #ETH-PORT _port_type, port_id<CR> <b>FEEDBACK</b> ~nn@ETH-PORT _port_type, port_id<CR><LF>	port_type - TCP/UDP port_id - TCP/UDP port number (0 - 65535)	Set the Ethernet port protocol for TCP to 12457: #ETH-PORT _port_type, port_id<CR>
ETH-PORT?	Get Ethernet port protocol.  ⓘ If the port number you enter is already in use, an error is returned. The port number must be within the following range: 0-(2 <sup>16</sup> -1).	<b>COMMAND</b> #ETH-PORT? _port_type<CR> <b>FEEDBACK</b> ~nn@ETH-PORT? _port_type, port_id<CR><LF>	port_type - TCP/UDP port_id - TCP/UDP port number (0 - 65535)	Get the Ethernet port protocol for UDP: #ETH-PORT? _port_type, port_id<CR>
ETH-TUNNEL?	Get an open tunnel parameters.	<b>COMMAND</b> #ETH-TUNNEL? _tunnel_id<CR> <b>FEEDBACK</b> ~nn@ETH-TUNNEL? _tunnel_id, cmd_name, port_type, port_id, eth_ip, remote_port_id, eth_rep_en, connection_type<CR><LF>	tunnel_id - Tunnel ID number, * (get all open tunnels) cmd_name - UART number port_type - TCP/UDP 0 - TCP 1 - UDP port_id - TCP/UDP port number eth_ip - Client IP address remote_port_id - Remote port number eth_rep_en - Ethernet Reply 0 - COM port does not send replies to new clients 1 - COM port sends replies to new clients connection_type - Connection type 0 - not wired connection 1 - wired connection	Set baud rate to 9600, 8 data bits, parity to none and stop bit to 1: #ETH-TUNNEL? _tunnel_id, cmd_name, port_type, port_id, eth_ip, remote_port_id, eth_rep_en, connection_type<CR>
FACTORY	Reset device to factory default configuration.  ⓘ This command deletes all user data from the device. The deletion can take some time.  Your device may require powering off and powering on for the changes to take effect.	<b>COMMAND</b> #FACTORY<CR> <b>FEEDBACK</b> ~nn@FACTORY _ok<CR><LF>		Reset the device to factory default configuration: #FACTORY<CR>

Function	Description	Syntax	Parameters/Attributes	Example
<b>FW-TYPE?</b>	Get the current FW type status.  Used by Kramer Network and KUpload to identify recovery process.	<b>COMMAND</b> #FW-TYPE?_<CR> <b>FEEDBACK</b> ~nn@FEATURE-LIST_fw_type<CR><LF>	<b>Fw_type</b> – 0 – Application 1 – Safe mode (kboot)	Get the current FW type status: #FW-TYPE?_<CR>
<b>GLOBAL-GW-ACTIVE</b>	Set global gateway to active / inactive.	<b>COMMAND</b> #GLOBAL-GW-ACTIVE_status<CR> <b>FEEDBACK</b> ~nn@GLOBAL-GW-ACTIVE_status<CR><LF>	<b>status</b> – On/Off ON – Active Off – Inactive	Set global gateway off: #AUDIO-BYPASS_OFF<CR>
<b>GLOBAL-GW-ACTIVE?</b>	Set global gateway to active / inactive.	<b>COMMAND</b> #GLOBAL-GW-ACTIVE?<CR> <b>FEEDBACK</b> ~nn@GLOBAL-GW-ACTIVE_status<CR><LF>	<b>status</b> – On/Off ON – Active Off – Inactive	Get global gateway off: #AUDIO-BYPASS?<CR>
<b>GPIO-CFG</b>	Set HW GPIO configuration.	<b>COMMAND</b> #GPIO-CFG_gpio_id, gpio_type, gpio_dir, pullup<CR> <b>FEEDBACK</b> ~nn@GPIO-CFG_gpio_id, gpio_type, gpio_dir<CR><LF>	<b>gpio_id</b> – Hardware GPIO number (1-2) <b>gpio_type</b> – Hardware GPIO type 0 – analog 1 – digital <b>gpio_dir</b> – Hardware GPIO direction 0 – input 1 – output <b>pullup</b> – Enable/Disable pull-up 0 – disable 1 – enable	Set HW GPIO 1 configuration: #GPIO-CFG_1,1,1,1<CR>
<b>GPIO-CFG?</b>	Get HW GPIO configuration.	<b>COMMAND</b> #GPIO-CFG?_gpio_id<CR> <b>FEEDBACK</b> ~nn@GPIO-CFG_gpio_id, gpio_type, gpio_dir<CR><LF>	<b>gpio_id</b> – Hardware GPIO number (1-2) <b>gpio_type</b> – Hardware GPIO type 0 – analog 1 – digital <b>gpio_dir</b> – Hardware GPIO direction 0 – input 1 – output <b>pullup</b> – Enable/Disable pull-up 0 – disable 1 – enable	Get HW GPIO configuration: #GPIO-CFG_1<CR>
<b>GPIO-STATE</b>	Set HW GPIO state.  <b>i</b> GPIO-STATE? can only be set in digital out mode and the answer is 0=Low, 1=High. In all other modes an error message is sent.  The device uses this command to notify the user of any change regarding the step and voltage in:  In digital mode the answer is 0 (low), 1 (high).  In analog mode the answer is 0 to 100.	<b>COMMAND</b> #GPIO-STATE_gpio_id, gpio_mode<CR> <b>FEEDBACK</b> ~nn@GPIO-STATE_gpio_id, gpio_mode<CR><LF>	<b>gpio_id</b> – Hardware GPIO number (1-2) <b>gpio_mode</b> – Hardware GPIO state 0 – Low 1 – High	Set GPIO 2 to High: #GPIO-STATE_2, 1<CR>
<b>GPIO-STATE?</b>	Get HW GPIO state.  <b>i</b> GPIO-STATE? can only be set in digital out mode and the answer is 0=Low, 1=High. In all other modes an error message is sent.  The device uses this command to notify the user of any change regarding the step and voltage in:  In digital mode the answer is 0 (low), 1 (high).  In analog mode the answer is 0 to 100.	<b>COMMAND</b> #GPIO-STATE?_gpio_id<CR> <b>FEEDBACK</b> ~nn@GPIO-STATE_gpio_id, gpio_mode<CR><LF>	<b>gpio_id</b> – Hardware GPIO number (1-2) <b>gpio_mode</b> – Hardware GPIO state 0 – Low 1 – High	Get GPIO 2 state: #GPIO-STATE?_2<CR>
<b>GPIO-STEP</b>	Set HW GPIO step.  <b>i</b> In digital mode the response is 2.  In analog mode the response is 1 to 100.  In other modes an error is returned.	<b>COMMAND</b> #GPIO-STEP_gpio_id, step_id<CR> <b>FEEDBACK</b> ~nn@GPIO-STEP_gpio_id, step_id, currentstep<CR><LF>	<b>gpio_id</b> – HW GPIO number (1-2) <b>step_id</b> – The configuration step – See note in description. <b>currentstep</b> – The actual step depending on the measured voltage	Set GPIO 2 (set to Analog In) configuration step to 38mV: #GPIO-STEP_2, 38<CR>

Function	Description	Syntax	Parameters/Attributes	Example
GPIO-STEP?	Get HW GPIO step.  ⓘ In digital mode the response is 2.  In analog mode the response is 1 to 100.  In other modes an error is returned.	<b>COMMAND</b> #GPIO-STEP?_gpio_id<CR> <b>FEEDBACK</b> ~nn@GPIO-STEP_gpio_id,step_id,currentstep<CR><LF>	gpio_id – HW GPIO number (1-2) step_id – The configuration step – See note in description. currentstep – The actual step depending on the measured voltage	Get GPIO 2 configuration: #GPIO-STEP?_2<CR>
GPIO-THR	Set HW GPIO voltage levels.	<b>COMMAND</b> #GPIO-THR_gpio_id,low_level,high_level<CR> <b>FEEDBACK</b> ~nn@GPIO-THR_gpio_id,low_level,high_level<CR><LF>	gpio_id – Hardware GPIO number (1-2) low_level – Voltage 500 to 28000 millivolts high_level – Voltage 2000 to 30000 millivolts	Set GPIO 2 to a low level of 800mV and a high level of 2200mV: #GPIO-THR_2,800,2200<CR>
GPIO-THR?	Get HW GPIO voltage levels that were set.	<b>COMMAND</b> #GPIO-THR?_gpio_id<CR> <b>FEEDBACK</b> ~nn@GPIO-THR_gpio_id,low_level,high_level<CR><LF>	gpio_id – Hardware GPIO number (1-2) low_level – Voltage 500 to 28000 millivolts high_level – Voltage 2000 to 30000 millivolts	Get GPIO 2: #GPIO-THR?_2<CR>
GPIO-VOLT?	Get active voltage levels of HW GPIO.  ⓘ This command is not available in digital out mode.	<b>COMMAND</b> GPIO-VOLT?_gpio_id<CR> <b>FEEDBACK</b> ~nn@GPIO-VOLT_gpio_id,voltage<CR><LF>	gpio_id – Hardware GPIO number (1-2) voltage – Voltage 0 to 30000 millivolts	Get GPIO 1 voltage: #GPIO-VOLT?_1<CR>
HDCP-OUT	Set HDCP mode.  ⓘ Get HDCP working mode on the device input:  HDCP supported – HDCP ON [default].  HDCP not supported - HDCP OFF.  HDCP support changes following detected sink - MIRROR OUTPUT.	<b>COMMAND</b> #HDCP-OUT_out_index,mode<CR> <b>FEEDBACK</b> ~nn@HDCP-OUT_out_index,mode<CR><LF>	out_index – Number that indicates the specific input: 1 – HDBaset OUT mode – HDCP mode: 0 – Follow Input 1 – HDCP always ON (i.e. output signal is always HDCP-encrypted, regardless of input HDCP)	Set the output HDCP mode of HDBaseT OUT to follow input: #HDCP-OUT_1,0<CR>
HDCP-OUT?	Get HDCP mode.  ⓘ Get HDCP working mode on the device input:  HDCP supported – HDCP ON [default].  HDCP not supported - HDCP OFF.  HDCP support changes following detected sink - MIRROR OUTPUT.	<b>COMMAND</b> #HDCP-OUT?_out_index<CR> <b>FEEDBACK</b> ~nn@HDCP-OUT_out_index,mode<CR><LF>	out_index – Number that indicates the specific input: 1 – HDBaset OUT mode – HDCP mode: 0 – Follow Input 1 – HDCP always ON (i.e. output signal is always HDCP-encrypted, regardless of input HDCP)	Get the output HDCP-MODE of HDBaseT OUT: #HDCP-OUT?_1<CR>
HELP	Get command list or help for specific command.	<b>COMMAND</b> #HELP<CR> #HELP_cmd_name<CR> <b>FEEDBACK</b> 1. Multi-line: ~nn@Device_cmd_name,_cmd_name..<CR><LF> To get help for command use: HELP (COMMAND_NAME)<CR><LF> ~nn@HELP_cmd_name:<CR><LF> description<CR><LF> USAGE: usage<CR><LF>	cmd_name – Name of a specific command	Get the command list: #HELP<CR>  To get help for AV-SW-TIMEOUT: HELP_av-sw-timeout<CR>
IDV	Set visual indication from device.  ⓘ Using this command, some devices can light a sequence of buttons or LEDs to allow identification of a specific device from similar devices.	<b>COMMAND</b> #IDV<CR> <b>FEEDBACK</b> ~nn@IDV_ok<CR><LF>		#IDV<CR>
LOG-TAIL?	Get the list of the N last events.	<b>COMMAND</b> #LOG-TAIL?_last_event<CR> <b>FEEDBACK</b> ~nn@LOG-TAIL_last_event,ok,<list><CR><LF>	last_event – the number of last events to view <N = 1,2,3...>	Get the protocol permission level to Admin: #LOG-TAIL?_8<CR>

Function	Description	Syntax	Parameters/Attributes	Example
LOGIN	<p>Set protocol permission.</p> <p><b>i</b> The permission system works only if security is enabled with the "SECUR" command.</p> <p>LOGIN allows the user to run commands with an End User or Administrator permission level. When the permission system is enabled, LOGIN enables running commands with the User or Administrator permission level. When set, login must be performed upon each connection.</p> <p>It is not mandatory to enable the permission system in order to use the device.</p> <p>In each device, some connections allow logging in to different levels. Some do not work with security at all.</p> <p>Connection may logout after timeout.</p>	<p><b>COMMAND</b></p> <pre>#LOGIN_login_level,password&lt;CR&gt;</pre> <p><b>FEEDBACK</b></p> <pre>~nn@LOGIN_login_level,password_ok&lt;CR&gt;&lt;LF&gt;</pre> <p>or</p> <pre>~nn@LOGIN_err_004&lt;CR&gt;&lt;LF&gt;</pre> <p>(if bad password entered)</p>	<p><b>login_level</b> – Level of permissions required (User or Admin)</p> <p><b>password</b> – Predefined password (by PASS command). Default password is an empty string</p>	<p>Set the protocol permission level to Admin (when the password defined in the PASS command is 33333):</p> <pre>#LOGIN_admin,33333&lt;CR&gt;</pre>
LOGIN?	<p>Get protocol permission state.</p> <p><b>i</b> The permission system works only if security is enabled with the "SECUR" command.</p> <p>LOGIN allows the user to run commands with an End User or Administrator permission level. When the permission system is enabled, LOGIN enables running commands with the User or Administrator permission level. When set, login must be performed upon each connection.</p> <p>It is not mandatory to enable the permission system in order to use the device.</p> <p>In each device, some connections allow logging in to different levels. Some do not work with security at all.</p> <p>Connection may logout after timeout.</p>	<p><b>COMMAND</b></p> <pre>#LOGIN_login_level &lt;CR&gt;</pre> <p><b>FEEDBACK</b></p> <pre>~nn@LOGIN_login_level,password_ok&lt;CR&gt;&lt;LF&gt;</pre> <p>or</p> <pre>~nn@LOGIN_err_004&lt;CR&gt;&lt;LF&gt;</pre> <p>(if bad password entered)</p>	<p><b>login_level</b> – Level of permissions required (User or Admin)</p> <p><b>password</b> – Predefined password (by PASS command). Default password is an empty string or NO SECURE if authentication is removed.</p>	<p>Get the protocol permission level to Admin:</p> <pre>#LOGIN?_admin&lt;CR&gt;</pre>
LOGOUT	<p>Cancel current permission level.</p> <p><b>i</b> Logs out from End User or Administrator permission levels to Not Secure.</p>	<p><b>COMMAND</b></p> <pre>#LOGOUT&lt;CR&gt;</pre> <p><b>FEEDBACK</b></p> <pre>~nn@LOGOUT_ok&lt;CR&gt;&lt;LF&gt;</pre>		<pre>#LOGOUT&lt;CR&gt;</pre>
MODEL?	<p>Get device model.</p>	<p><b>COMMAND</b></p> <pre>#MODEL?_&lt;CR&gt;</pre> <p><b>FEEDBACK</b></p> <pre>~nn@MODEL_model_name&lt;CR&gt;&lt;LF&gt;</pre>	<p><b>model_name</b> – String of up to 19 printable ASCII chars</p>	<p>Get the device model:</p> <pre>#MODEL?_&lt;CR&gt;</pre>
NAME	<p>Set machine (DNS) name.</p> <p><b>i</b> The machine name is not the same as the model name. The machine name is used to identify a specific machine or a network in use (with DNS feature on).</p>	<p><b>COMMAND</b></p> <pre>#NAME_machine_name&lt;CR&gt;</pre> <p><b>FEEDBACK</b></p> <pre>~nn@NAME_machine_name&lt;CR&gt;&lt;LF&gt;</pre>	<p><b>machine_name</b> – String of up to 15 alpha-numeric chars (can include hyphen, not at the beginning or end)</p>	<p>Set the DNS name of the device to room-442:</p> <pre>#NAME_room-442&lt;CR&gt;</pre>

Function	Description	Syntax	Parameters/Attributes	Example
NAME?	<p>Get machine (DNS) name.</p> <p><b>i</b> The machine name is not the same as the model name. The machine name is used to identify a specific machine or a network in use (with DNS feature on).</p>	<p><b>COMMAND</b></p> <pre>#NAME?_&lt;CR&gt;</pre> <p><b>FEEDBACK</b></p> <pre>~nn@NAME_machine_name&lt;CR&gt;&lt;LF&gt;</pre>	<p><b>machine_name</b> – String of up to 15 alpha-numeric chars (can include hyphen, not at the beginning or end)</p>	<p>Get the DNS name of the device:</p> <pre>#NAME?_&lt;CR&gt;</pre>
NAME-RST	<p>Reset machine (DNS) name to factory default.</p> <p><b>i</b> Factory default of machine (DNS) name is "KRAMER." + 4 last digits of device serial number.</p>	<p><b>COMMAND</b></p> <pre>#NAME-RST&lt;CR&gt;</pre> <p><b>FEEDBACK</b></p> <pre>~nn@NAME-RST_ok&lt;CR&gt;&lt;LF&gt;</pre>		<p>Reset the machine name (S/N last digits are 0102):</p> <pre>#NAME-RST_kramer_0102&lt;CR&gt;</pre>
NET-CONFIG	<p>Set a network configuration.</p> <p><b>i</b> Parameters [DNS1] and [DNS2] are optional.</p> <p><b>i</b> For Backward compatibility, the <b>id</b> parameter can be omitted. In this case, the Network ID, by default, is 0, which is the Ethernet control port.</p> <p><b>i</b> If the gateway address is not compliant to the subnet mask used for the host IP, the command will return an error. Subnet and gateway compliancy specified by RFC950.</p>	<p><b>COMMAND</b></p> <pre>#NET-CONFIG_netw_id,net_ip,net_mask,gateway,[dns1],[dns2]&lt;CR&gt;</pre> <p><b>FEEDBACK</b></p> <pre>~nn@NET-CONFIG_netw_id,net_ip,net_mask,gateway&lt;CR&gt;&lt;LF&gt;</pre>	<p><b>netw_id</b> – 0</p> <p><b>net_ip</b> – Network IP</p> <p><b>net_mask</b> – Network mask</p> <p><b>gateway</b> – Network gateway</p>	<p>Set the device network parameters to IP address 192.168.113.10, net mask 255.255.0.0, and gateway 192.168.0.1:</p> <pre>#NET-CONFIG_0,192.168.113.10,255.255.0.0,192.168.0.1&lt;CR&gt;</pre>
NET-CONFIG?	<p>Get a network configuration.</p> <p><b>i</b> Parameters [DNS1] and [DNS2] are optional.</p> <p><b>i</b> For Backward compatibility, the <b>id</b> parameter can be omitted. In this case, the Network ID, by default, is 0, which is the Ethernet control port.</p> <p><b>i</b> If the gateway address is not compliant to the subnet mask used for the host IP, the command will return an error. Subnet and gateway compliancy specified by RFC950.</p>	<p><b>COMMAND</b></p> <pre>#NET-CONFIG_netw_id,net_ip,net_mask,gateway,[dns1],[dns2]&lt;CR&gt;</pre> <p><b>FEEDBACK</b></p> <pre>~nn@NET-CONFIG_netw_id,net_ip,net_mask,gateway&lt;CR&gt;&lt;LF&gt;</pre>	<p><b>netw_id</b> – 0</p> <p><b>net_ip</b> – Network IP</p> <p><b>net_mask</b> – Network mask</p> <p><b>gateway</b> – Network gateway</p>	<p>Get the device network parameters:</p> <pre>#NET-CONFIG?_0&lt;CR&gt;</pre>
NET-DHCP?	<p>Get DHCP mode.</p> <p><b>i</b> For Backward compatibility, the <b>id</b> parameter can be omitted. In this case, the Network ID, by default, is 0, which is the Ethernet control port.</p>	<p><b>COMMAND</b></p> <pre>#NET-DHCP?_netw_id&lt;CR&gt;</pre> <p><b>FEEDBACK</b></p> <pre>~nn@NET-DHCP_netw_id,dhcp_state&lt;CR&gt;&lt;LF&gt;</pre>	<p><b>netw_id</b> – Network ID—the device network interface (if there are more than one). Counting is 0 based, meaning the control port is '0', additional ports are 1,2,3....</p> <p><b>dhcp_state</b> –</p> <ul style="list-style-type: none"> <li>0 – Do not use DHCP. Use the IP set by the factory or using the <b>net-ip</b> or <b>net-config</b> command.</li> <li>1 – Try to use DHCP. If unavailable, use the IP set by the factory or using the <b>net-ip</b> or <b>net-config</b> command.</li> </ul>	<p>Get DHCP mode for port 1:</p> <pre>#NET-DHCP?_1&lt;CR&gt;</pre>
NET-GATE	<p>Set gateway IP.</p> <p><b>i</b> A network gateway connects the device via another network and maybe over the Internet. Be careful of security issues. For proper settings consult your network administrator.</p>	<p><b>COMMAND</b></p> <pre>#NET-GATE_ip_address&lt;CR&gt;</pre> <p><b>FEEDBACK</b></p> <pre>~nn@NET-GATE_ip_address&lt;CR&gt;&lt;LF&gt;</pre>	<p><b>ip_address</b> – Format: xxx.xxx.xxx.xxx</p>	<p>Set the gateway IP address to 192.168.0.1:</p> <pre>#NET-GATE_192.168.000.001&lt;CR&gt;</pre>
NET-GATE?	<p>Get gateway IP.</p> <p><b>i</b> A network gateway connects the device via another network and maybe over the Internet. Be aware of security problems.</p>	<p><b>COMMAND</b></p> <pre>#NET-GATE?_&lt;CR&gt;</pre> <p><b>FEEDBACK</b></p> <pre>~nn@NET-GATE_ip_address&lt;CR&gt;&lt;LF&gt;</pre>	<p><b>ip_address</b> – Format: xxx.xxx.xxx.xxx</p>	<p>Get the gateway IP address:</p> <pre>#NET-GATE?_&lt;CR&gt;</pre>



Function	Description	Syntax	Parameters/Attributes	Example
NET-IP	Set IP address.  ❗ For proper settings consult your network administrator.	<b>COMMAND</b> #NET-IP_ip_address<CR> <b>FEEDBACK</b> ~nn@NET-IP_ip_address<CR><LF>	ip_address – Format: xxx.xxx.xxx.xxx	Set the IP address to 192.168.1.39: #NET-IP_192.168.001.039<CR>
NET-IP?	Get IP address.	<b>COMMAND</b> #NET-IP?_<CR> <b>FEEDBACK</b> ~nn@NET-IP_ip_address<CR><LF>	ip_address – Format: xxx.xxx.xxx.xxx	Get the IP address: #NET-IP?_<CR>
NET-MAC?	Get MAC address.  ❗ For backward compatibility, the id parameter can be omitted. In this case, the Network ID, by default, is 0, which is the Ethernet control port.	<b>COMMAND</b> #NET-MAC?_id<CR> <b>FEEDBACK</b> ~nn@NET-MAC_id,mac_address<CR><LF>	id – Network ID—the device network interface (if there are more than one). Counting is 0 based, meaning the control port is '0', additional ports are 1,2,3... mac_address – Unique MAC address. Format: XX-XX-XX-XX-XX-XX where X is hex digit	#NET-MAC?_id<CR>
NET-MASK	Set subnet mask.  ❗ For proper settings consult your network administrator.	<b>COMMAND</b> #NET-MASK_net_mask<CR> <b>FEEDBACK</b> ~nn@NET-MASK_net_mask<CR><LF>	net_mask – Format: xxx.xxx.xxx.xxx	Set the subnet mask to 255.255.0.0: #NET-MASK_255.255.000.000<CR>
NET-MASK?	Get subnet mask.	<b>COMMAND</b> #NET-MASK?_<CR> <b>FEEDBACK</b> ~nn@NET-MASK_net_mask<CR><LF>	net_mask – Format: xxx.xxx.xxx.xxx	Get the subnet mask: #NET-MASK?<CR>
PASS	Set password for login level.  ❗ The default password is an empty string.	<b>COMMAND</b> #PASS_login_level,password<CR> <b>FEEDBACK</b> ~nn@PASS_login_level,password<CR><LF>	login_level – Level of login to set (End User or Administrator). password – Password for the login_level. Up to 15 printable ASCII chars	Set the password for the Admin protocol permission level to 33333: #PASS_admin,33333<CR>
PASS?	Get password for login level.  ❗ The default password is an empty string.	<b>COMMAND</b> #PASS_login_level <CR> <b>FEEDBACK</b> ~nn@PASS_login_level,password<CR><LF>	login_level – Level of login to set (End User or Administrator). password – Password for the login_level. Up to 15 printable ASCII chars	Get the password for the Admin protocol permission: #PASS?_admin<CR>
PRG-ACTION	Add new user command.  ❗ Programs matrix action as a response for external event (programmable button pressed).	<b>COMMAND</b> #PRG-ACTION_commandNum,type,name,command<CR> <b>FEEDBACK</b> ~nn@PRG-ACTION_commandNum,type,name,command<CR><LF>	commandNum – Command number 0 to 4 type – External programmable button cec name – Bitmap representing command – External programmable button ID	Add a new user command: #PRG-ACTION_1,3,1,0<CR>
PRG-ACTION?	Add new user command.  ❗ Programs matrix action as a response for external event (programmable button pressed).	<b>COMMAND</b> #PRG-ACTION?_commandNum<CR> <b>FEEDBACK</b> ~nn@PRG-ACTION_commandNum,type,name,command<CR><LF>	commandNum – Command number 0 – Input 1 – Output type – External programmable button ID name – Bitmap representing command – External programmable button ID	Add a new user command: #PRG-ACTION?_0,3,1,0<CR>

Function	Description	Syntax	Parameters/Attributes	Example
PRG-BTN-ACTION	Set program button mode	<p><b>COMMAND</b></p> <pre>#PROG-BTN- MOD_btnNum,mode,actionOn,actionOff,btnBehavior&lt;CR&gt;</pre> <p><b>FEEDBACK</b></p> <pre>~nn@PROG-BTN- MOD_btnNum,mode,actionOn,actionOff,btnBehavior&lt;CR&gt;&lt;LF&gt; &gt;</pre>	<p><b>btnNum</b> – Button number 0 to 4 1 and 2 are enabled when remote button is (<b>mode</b>) On 1 – IO 1 button 2 – IO 2 button 3 – Display On button</p> <p><b>mode</b> – Remote button state 0 – Off 1 – On</p> <p><b>actionOn</b> – 100 – None 101 – Switch Input 102 – Display On (via CEC) 103 – Display Off (via CEC) 104 – Mute 105 – Unmute 106 – Volume ++ 107 – Volume -- 0 – Command_01 1 – Command_02 2 – Command_03 3 – Command_04 4 – Custom 5</p> <p><b>actionOff</b> – Button_mode 100 – None 101 – Switch Input 102 – Display On (via CEC) 103 – Display Off (via CEC) 104 – Mute 105 – Unmute 106 – Volume ++ 107 – Volume -- 0 – Command_01 1 – Command_02 2 – Command_03 3 – Command_04 4 – Custom 5</p> <p><b>btnBehavior</b> – Button_mode 0 – Momentary mode disabled 1 – Momentary mode enabled</p>	Set the DISPLAY ON button to mute/unmute with the press of a button: #PROG-BTN-MOD_3,1,104,105,0<CR>
PROG-BTN-MOD?	Get programmable buttons mode	<p><b>COMMAND</b></p> <pre>#PROG-BTN-MOD?&lt;CR&gt;</pre> <p><b>FEEDBACK</b></p> <pre>~nn@PROG-BTN-MOD_button_mode&lt;CR&gt;&lt;LF&gt;</pre>	<p><b>btnNum</b> – Button number 0 to 4 1 and 2 are enabled when remote button is (<b>mode</b>) On 1 – IO 1 button 2 – IO 2 button 3 – Display On button</p> <p><b>mode</b> – Remote button state 0 – Off 1 – On</p> <p><b>actionOn</b> – 100 – None 101 – Switch Input 102 – Display On (via CEC) 103 – Display Off (via CEC) 104 – Mute 105 – Unmute 106 – Volume ++ 107 – Volume -- 0 – Command_01 1 – Command_02 2 – Command_03 3 – Command_04 4 – Custom 5</p> <p><b>actionOff</b> – Button_mode 100 – None 101 – Switch Input 102 – Display On (via CEC) 103 – Display Off (via CEC) 104 – Mute 105 – Unmute 106 – Volume ++ 107 – Volume -- 0 – Command_01 1 – Command_02 2 – Command_03 3 – Command_04 4 – Custom 5</p> <p><b>btnBehavior</b> – Button_mode 0 – Momentary mode disabled 1 – Momentary mode enabled</p>	Get the mode of button 3: #PROG-BTN-MOD?_3<CR>
PRIORITY	Set input priority.	<p><b>COMMAND</b></p> <pre>#PRIORITY_layer_type,priority_1,priority_2,priority_3 &lt;CR&gt;</pre> <p><b>FEEDBACK</b></p> <pre>~nn@PRIORITY_layer_type,priority_1,priority_2,priorit y_3&lt;CR&gt;&lt;LF&gt;</pre>	<p><b>layer_type</b> – Layer Enumeration 1 – Video</p> <p><b>priority</b> – Priority of inputs (1-2) 1 – USB-C 1 2 – HDMI 2 3 – HDMI 3</p>	Set the priority to first HDMI 2, USB-C 1 second and HDMI 3 third: #PRIORITY_1,2,1,3<CR>

Function	Description	Syntax	Parameters/Attributes	Example
PRIORITY?	Set input priority.	<b>COMMAND</b> #PRIORITY?_layer_type<CR> <b>FEEDBACK</b> ~nn@PRIORITY_layer_type,priority_1,priority_2,priority_3<CR><LF>	<b>layer_type</b> – Layer Enumeration 1 – Video <b>priority</b> – Priority of inputs (1-2) 1 – USB-C 1 2 – HDMI 2 3 – HDMI 3	Get the input priority: #PRIORITY?_1<CR>
PROT-VER?	Get device protocol version.	<b>COMMAND</b> #PROT-VER?_<CR> <b>FEEDBACK</b> ~nn@PROT-VER_3000:version<CR><LF>	<b>version</b> – XX.XX where X is a decimal digit	Get the device protocol version: #PROT-VER?_<CR>
RESET	Reset device.  <b>i</b> To avoid locking the port due to a USB bug in Windows, disconnect USB connections immediately after running this command. If the port was locked, disconnect, and reconnect the cable to reopen the port.	<b>COMMAND</b> #RESET<CR> <b>FEEDBACK</b> ~nn@RESET_ok<CR><LF>		Reset the device: #RESET<CR>
ROUTE	Set layer routing.  <b>i</b> This command replaces all other routing commands.	<b>COMMAND</b> #ROUTE_layer_type,out_index,in_index<CR> <b>FEEDBACK</b> ~nn@ROUTE_layer_type,out_index,in_index<CR><LF>	<b>layer_type</b> Layer Enumeration 1 – Video 5 – USB <b>out_index</b> 1 – Output <b>in_index</b> – Source id for Video: 1 – USB-C 1 2 – HDMI IN 2 3 – HDMI IN 3	Route video input 2 to the output: #ROUTE_1,1,2<CR>
ROUTE?	Get layer routing state.  <b>i</b> This command replaces all other routing commands.	<b>COMMAND</b> #ROUTE?_layer_type,out_index<CR> <b>FEEDBACK</b> ~nn@ROUTE_layer_type,out_index,in_index <CR><LF>	<b>layer_type</b> Layer Enumeration 1 – Video 5 – USB <b>out_index</b> 1 – Output <b>in_index</b> – Source id for Video: 1 – USB-C 1 2 – HDMI IN 2 3 – HDMI IN 3	Get video routing output: #ROUTE?_1,1<CR>
SECUR	Start/stop security.  <b>i</b> The permission system works only if security is enabled with the "SECUR" command.	<b>COMMAND</b> #SECUR_security_state<CR> <b>FEEDBACK</b> ~nn@SECUR_security_state<CR><LF>	<b>security_state</b> – Security state 0 – OFF (disables security) 1 – ON (enables security)	Enable the permission system: #SECUR_1<CR>
SECUR?	Get security state.  <b>i</b> The permission system works only if security is enabled with the "SECUR" command.	<b>COMMAND</b> #SECUR?_security_state<CR> <b>FEEDBACK</b> ~nn@SECUR_security_state<CR><LF>	<b>security_state</b> – Security state 0 – OFF (disables security) 1 – ON (enables security)	Enable the permission system: #SECUR?_<CR>
SIGNAL-USB-HOST?	Get if there is an active host connected to the port.	<b>COMMAND</b> #SIGNAL-USB-HOST?_host_index<CR> <b>FEEDBACK</b> ~nn@SIGNAL-USB-HOST_host_index,state<CR><LF>	<b>host_index</b> : the number of the host port 1-N <b>state</b> : Active/Inactive 0 – Active 1 – Inactive	Get if there is active host connected to port 2: #SIGNAL-USB-HOST?_2<CR>
SN?	Get device serial number.	<b>COMMAND</b> #SN?_<CR> <b>FEEDBACK</b> ~nn@SN_serial_num<CR><LF>	<b>serial_num</b> – 14 decimal digits, factory assigned	Get the device serial number: #SN?_<CR>
TIME	Set device time and date.  <b>i</b> The year must be 4 digits.  The device does not validate the day of week from the date.  Time format - 24 hours.  Date format - Day, Month, Year.	<b>COMMAND</b> #TIME_day_of_week,date,data<CR> <b>FEEDBACK</b> ~nn@TIME_day_of_week,date,data<CR><LF>	<b>day_of_week</b> – One of {SUN,MON,TUE,WED,THU,FRI,SAT} <b>date</b> – Format: DD-MM-YYYY. <b>data</b> – Format: hh:mm:ss where hh = hours mm = minutes ss = seconds	Set device time and date to December 5, 2020 at 2:30pm: #TIME_mon_05-12-2020,14:30:00<CR>
TIME?	Get device time and date.  <b>i</b> The year must be 4 digits.  The device does not validate the day of week from the date.  Time format - 24 hours.  Date format - Day, Month, Year.	<b>COMMAND</b> #TIME?_<CR> <b>FEEDBACK</b> ~nn@TIME_day_of_week,date,data<CR><LF>	<b>day_of_week</b> – One of {SUN,MON,TUE,WED,THU,FRI,SAT} <b>date</b> – Format: YYYY/MM/DD where YYYY = Year MM = Month DD = Day <b>data</b> – Format: hh:mm:ss where hh = hours mm = minutes ss = seconds	Get device time and date: #TIME?<CR>

Function	Description	Syntax	Parameters/Attributes	Example
TIME-LOC	Set local time offset from UTC/GMT.  <p><b>i</b> If the time server is configured, device time calculates by adding UTC_off to UTC time (that it got from the time server) + 1 hour if daylight savings time is in effect.</p> <p>TIME command sets the device time without considering these settings.</p>	<b>COMMAND</b> #TIME-LOC,utc_off,dst_state<CR> <b>FEEDBACK</b> ~nn@TIME-LOC,utc_off,dst_state<CR><LF>	utc_off – Offset of device time from UTC/GMT (without daylight time correction) dst_state – Daylight saving time state 0 – no daylight saving time 1 – daylight saving time	Set local time offset to 3 with no daylight-saving time: #TIME-LOC,3,0<CR>
TIME-LOC?	Get local time offset from UTC/GMT.  <p><b>i</b> If the time server is configured, device time calculates by adding UTC_off to UTC time (that it got from the time server) + 1 hour if daylight savings time is in effect.</p> <p>TIME command sets the device time without considering these settings.</p>	<b>COMMAND</b> #TIME-LOC?,<CR> <b>FEEDBACK</b> ~nn@TIME-LOC,utc_off,dst_state<CR><LF>	utc_off – Offset of device time from UTC/GMT (without daylight time correction) dst_state – Daylight saving time state 0 – no daylight saving time 1 – daylight saving time	Get local time offset from UTC/GMT: #TIME-LOC?<CR>
TIME-SRV	Set time server.  <p><b>i</b> This command is needed for setting UDP timeout for the current client list.</p>	<b>COMMAND</b> #TIME-SRV,mode,time_server_ip,sync_hour<CR> <b>FEEDBACK</b> ~nn@TIME-SRV,mode,time_server_ip,sync_hour,server_status<CR><LF>	mode – On/Off 0 – Off 1 – On time_server_ip – Time server IP address sync_hour – Hour in day for time server sync server_status – On/Off	Set time server with IP address of 128.138.140.44 to ON: #TIME-SRV,1,128.138.140.44,0,1<CR>
TIME-SRV?	Get time server.  <p><b>i</b> This command is needed for setting UDP timeout for the current client list.</p>	<b>COMMAND</b> #TIME-SRV?,<CR> <b>FEEDBACK</b> ~nn@TIME-SRV,mode,time_server_ip,sync_hour,server_status<CR><LF>	mode – On/Off 0 – Off 1 – On time_server_ip – Time server IP address sync_hour – Hour in day for time server sync server_status – On/Off	Get time server: #TIME-SRV?<CR>
UART-CAT-LINK?	Get the CAT port that has been chosen to be linked to the local serial port (Transmitter).	<b>COMMAND</b> #UART-CAT-LINK,UART_id<CR> <b>FEEDBACK</b> ~nn@UART-CAT-LINK,UART_id,valens_port_id<CR><LF>	UART_id – local UART we want to use for id: 1 (= UART0) valens_port_id: the CAT port we want to connect to 1 = UART1 connected to A/A+B CAT port. 2 = UART2 connected to B CAT port.	Get the selection of CAT port that connected to local UART0 #UART-CAT-LINK?,1<CR>
UART-CAT-LINK	Set the CAT port that has been chosen.  <p>Setting the chosen CAT port to communicate with when in Extension mode.</p> <p>In Extension mode we are connecting the local UART and the CAT UART to make both sides communicate.</p> <p>(The data is passing through the HDBT to the RS232 in the remote receiver).</p>	<b>COMMAND</b> #UART-CAT-LINK,UART_id,CAT_port_id<CR> <b>FEEDBACK</b> ~nn@USBA-DISCONNECT-MODE,mode<CR><LF>	UART_id – local UART we want to use for id: 1 (= UART0) CAT_port_id: the CAT port we want to connect to 1 = UART1 connected to A/A+B CAT port. 2 = UART2 connected to B CAT port.	Set the selection to CAT port A/A+B, and local UART0 #UART-CAT-LINK,1,1<CR>
USBA-DISCONNECT-MODE	Set USB device auto-disconnection mode.	<b>COMMAND</b> #USBA-DISCONNECT-MODE,USBDevice,mode<CR> <b>FEEDBACK</b> ~nn@USBA-DISCONNECT-MODE,mode<CR><LF>	USBDevice – USB device number 1 – USB Device 1 2 – USB Device 2 3 – USB Device 3 4 – USB Device 4 mode – On/Off 0 – Off 1 – On	Set USB Device 1 polycm mode to ON: #USBA-DISCONNECT-MODE,1,1<CR>
USBA-DISCONNECT-MODE?	Get USB device auto-disconnection mode..	<b>COMMAND</b> #USBA-DISCONNECT-MODE?,USBDevice<CR> <b>FEEDBACK</b> ~nn@USBA-DISCONNECT-MODE,mode<CR><LF>	USBDevice – USB device number 1 – USB Device 1 2 – USB Device 2 3 – USB Device 3 4 – USB Device 4 mode – On/Off 0 – Off 1 – On	Get USB Device 1 polycm mode: #USBA-DISCONNECT-MODE?,1<CR>

USBC-ETH	Set USBC to Ethernet connection.	<b>COMMAND</b> #USBC-ETH_state<CR> <b>FEEDBACK</b> ~nn@USBC-ETH_state<CR><LF>	state – On/Off 0 – Off 1 – On	Set USBC to Ethernet connection state to ON: #USBC-ETH_1<CR>
----------	----------------------------------	----------------------------------------------------------------------------------------	-------------------------------------	-----------------------------------------------------------------

VERSION?	Get firmware version number.	<b>COMMAND</b> #VERSION?_<CR> <b>FEEDBACK</b> ~nn@VERSION_firmware_version<CR><LF>	firmware_version – XX.XX.XXXX where the digit groups are: major.minor.build version	Get the device firmware version number: #VERSION?_<CR>
----------	------------------------------	---------------------------------------------------------------------------------------------	-------------------------------------------------------------------------------------------	-----------------------------------------------------------

---

## Result and Error Codes

### Syntax

In case of an error, the device responds with an error message. The error message syntax:

- ~NN@ERR XXX<CR><LF> – when general error, no specific command
- ~NN@CMD ERR XXX<CR><LF> – for specific command
- NN – machine number of device, default = 01
- XXX – error code

## Error Codes

Error Name	Error Code	Description
P3K_NO_ERROR	0	No error
ERR_PROTOCOL_SYNTAX	1	Protocol syntax
ERR_COMMAND_NOT_AVAILABLE	2	Command not available
ERR_PARAMETER_OUT_OF_RANGE	3	Parameter out of range
ERR_UNAUTHORIZED_ACCESS	4	Unauthorized access
ERR_INTERNAL_FW_ERROR	5	Internal FW error
ERR_BUSY	6	Protocol busy
ERR_WRONG_CRC	7	Wrong CRC
ERR_TIMEDOUT	8	Timeout
ERR_RESERVED	9	(Reserved)
ERR_FW_NOT_ENOUGH_SPACE	10	Not enough space for data (firmware, FPGA...)
ERR_FS_NOT_ENOUGH_SPACE	11	Not enough space – file system
ERR_FS_FILE_NOT_EXISTS	12	File does not exist
ERR_FS_FILE_CANT_CREATED	13	File can't be created
ERR_FS_FILE_CANT_OPEN	14	File can't open
ERR_FEATURE_NOT_SUPPORTED	15	Feature is not supported
ERR_RESERVED_2	16	(Reserved)
ERR_RESERVED_3	17	(Reserved)
ERR_RESERVED_4	18	(Reserved)
ERR_RESERVED_5	19	(Reserved)
ERR_RESERVED_6	20	(Reserved)
ERR_PACKET_CRC	21	Packet CRC error
ERR_PACKET_MISSED	22	Packet number isn't expected (missing packet)
ERR_PACKET_SIZE	23	Packet size is wrong
ERR_RESERVED_7	24	(Reserved)
ERR_RESERVED_8	25	(Reserved)
ERR_RESERVED_9	26	(Reserved)
ERR_RESERVED_10	27	(Reserved)
ERR_RESERVED_11	28	(Reserved)
ERR_RESERVED_12	29	(Reserved)
ERR_EDID_CORRUPTED	30	EDID corrupted
ERR_NON_LISTED	31	Device specific errors
ERR_SAME_CRC	32	File has the same CRC – not changed
ERR_WRONG_MODE	33	Wrong operation mode
ERR_NOT_CONFIGURED	34	Device/chip was not initialized

The warranty obligations of Kramer Electronics Inc. ("Kramer Electronics") for this product are limited to the terms set forth below:

### **What is Covered**

This limited warranty covers defects in materials and workmanship in this product.

### **What is Not Covered**

This limited warranty does not cover any damage, deterioration or malfunction resulting from any alteration, modification, improper or unreasonable use or maintenance, misuse, abuse, accident, neglect, exposure to excess moisture, fire, improper packing and shipping (such claims must be presented to the carrier), lightning, power surges, or other acts of nature. This limited warranty does not cover any damage, deterioration or malfunction resulting from the installation or removal of this product from any installation, any unauthorized tampering with this product, any repairs attempted by anyone unauthorized by Kramer Electronics to make such repairs, or any other cause which does not relate directly to a defect in materials and/or workmanship of this product. This limited warranty does not cover cartons, equipment enclosures, cables or accessories used in conjunction with this product.

Without limiting any other exclusion herein, Kramer Electronics does not warrant that the product covered hereby, including, without limitation, the technology and/or integrated circuit(s) included in the product, will not become obsolete or that such items are or will remain compatible with any other product or technology with which the product may be used.

### **How Long this Coverage Lasts**

The standard limited warranty for Kramer products is seven (7) years from the date of original purchase, with the following exceptions:

1. All Kramer VIA hardware products are covered by a standard three (3) year warranty for the VIA hardware and a standard three (3) year warranty for firmware and software updates; all Kramer VIA accessories, adapters, tags, and dongles are covered by a standard one (1) year warranty.
2. Kramer fiber optic cables, adapter-size fiber optic extenders, pluggable optical modules, active cables, cable retractors, ring mounted adapters, portable power chargers, Kramer speakers, and Kramer touch panels are covered by a standard one (1) year warranty. Kramer 7-inch touch panels purchased on or after April 1st, 2020 are covered by a standard two (2) year warranty.
3. All Kramer Calibre products, all Kramer Minicom digital signage products, all HighSecLabs products, all streaming, and all wireless products are covered by a standard three (3) year warranty.
4. All Sierra Video MultiViewers are covered by a standard five (5) year warranty.
5. Sierra switchers & control panels are covered by a standard seven (7) year warranty (excluding power supplies and fans that are covered for three (3) years).
6. K-Touch software is covered by a standard one (1) year warranty for software updates.
7. All Kramer passive cables are covered by a lifetime warranty.

### **Who is Covered**

Only the original purchaser of this product is covered under this limited warranty. This limited warranty is not transferable to subsequent purchasers or owners of this product.

### **What Kramer Electronics Will Do**

Kramer Electronics will, at its sole option, provide one of the following three remedies to whatever extent it shall deem necessary to satisfy a proper claim under this limited warranty:

1. Elect to repair or facilitate the repair of any defective parts within a reasonable period of time, free of any charge for the necessary parts and labor to complete the repair and restore this product to its proper operating condition. Kramer Electronics will also pay the shipping costs necessary to return this product once the repair is complete.
2. Replace this product with a direct replacement or with a similar product deemed by Kramer Electronics to perform substantially the same function as the original product. If a direct or similar replacement product is supplied, the original product's end warranty date remains unchanged and is transferred to the replacement product.
3. Issue a refund of the original purchase price less depreciation to be determined based on the age of the product at the time remedy is sought under this limited warranty.

### **What Kramer Electronics Will Not Do Under This Limited Warranty**

If this product is returned to Kramer Electronics or the authorized dealer from which it was purchased or any other party authorized to repair Kramer Electronics products, this product must be insured during shipment, with the insurance and shipping charges prepaid by you. If this product is returned uninsured, you assume all risks of loss or damage during shipment. Kramer Electronics will not be responsible for any costs related to the removal or re-installation of this product from or into any installation. Kramer Electronics will not be responsible for any costs related to any setting up this product, any adjustment of user controls or any programming required for a specific installation of this product.

### **How to Obtain a Remedy Under This Limited Warranty**

To obtain a remedy under this limited warranty, you must contact either the authorized Kramer Electronics reseller from whom you purchased this product or the Kramer Electronics office nearest you. For a list of authorized Kramer Electronics resellers and/or Kramer Electronics authorized service providers, visit our web site at [www.kramerav.com](http://www.kramerav.com) or contact the Kramer Electronics office nearest you.

In order to pursue any remedy under this limited warranty, you must possess an original, dated receipt as proof of purchase from an authorized Kramer Electronics reseller. If this product is returned under this limited warranty, a return authorization number, obtained from Kramer Electronics, will be required (RMA number).

You may also be directed to an authorized reseller or a person authorized by Kramer Electronics to repair the product.

If it is decided that this product should be returned directly to Kramer Electronics, this product should be properly packed, preferably in the original carton, for shipping. Cartons not bearing a return authorization number will be refused.

### **Limitation of Liability**

THE MAXIMUM LIABILITY OF KRAMER ELECTRONICS UNDER THIS LIMITED WARRANTY SHALL NOT EXCEED THE ACTUAL PURCHASE PRICE PAID FOR THE PRODUCT. TO THE MAXIMUM EXTENT PERMITTED BY LAW, KRAMER ELECTRONICS IS NOT RESPONSIBLE FOR DIRECT, SPECIAL, INCIDENTAL OR CONSEQUENTIAL DAMAGES RESULTING FROM ANY BREACH OF WARRANTY OR CONDITION, OR UNDER ANY OTHER LEGAL THEORY. Some countries, districts or states do not allow the exclusion or limitation of relief, special, incidental, consequential or indirect damages, or the limitation of liability to specified amounts, so the above limitations or exclusions may not apply to you.

### **Exclusive Remedy**

TO THE MAXIMUM EXTENT PERMITTED BY LAW, THIS LIMITED WARRANTY AND THE REMEDIES SET FORTH ABOVE ARE EXCLUSIVE AND IN LIEU OF ALL OTHER WARRANTIES, REMEDIES AND CONDITIONS, WHETHER ORAL OR WRITTEN, EXPRESS OR IMPLIED. TO THE MAXIMUM EXTENT PERMITTED BY LAW, KRAMER ELECTRONICS SPECIFICALLY DISCLAIMS ANY AND ALL IMPLIED WARRANTIES, INCLUDING, WITHOUT LIMITATION, WARRANTIES OF MERCHANTABILITY AND FITNESS FOR A PARTICULAR PURPOSE. IF KRAMER ELECTRONICS CANNOT LAWFULLY DISCLAIM OR EXCLUDE IMPLIED WARRANTIES UNDER APPLICABLE LAW, THEN ALL IMPLIED WARRANTIES COVERING THIS PRODUCT, INCLUDING WARRANTIES OF MERCHANTABILITY AND FITNESS FOR A PARTICULAR PURPOSE, SHALL APPLY TO THIS PRODUCT AS PROVIDED UNDER APPLICABLE LAW. IF ANY PRODUCT TO WHICH THIS LIMITED WARRANTY APPLIES IS A "CONSUMER PRODUCT" UNDER THE MAGNUSON-MOSS WARRANTY ACT (15 U.S.C.A. §2301, ET SEQ.) OR OTHER APPLICABLE LAW, THE FOREGOING DISCLAIMER OF IMPLIED WARRANTIES SHALL NOT APPLY TO YOU, AND ALL IMPLIED WARRANTIES ON THIS PRODUCT, INCLUDING WARRANTIES OF MERCHANTABILITY AND FITNESS FOR THE PARTICULAR PURPOSE, SHALL APPLY AS PROVIDED UNDER APPLICABLE LAW.

### **Other Conditions**

This limited warranty gives you specific legal rights, and you may have other rights which vary from country to country or state to state.

This limited warranty is void if (i) the label bearing the serial number of this product has been removed or defaced, (ii) the product is not distributed by Kramer Electronics or (iii) this product is not purchased from an authorized Kramer Electronics reseller. If you are unsure whether a reseller is an authorized Kramer Electronics reseller, visit our web site at [www.kramerav.com](http://www.kramerav.com) or contact a Kramer Electronics office from the list at the end of this document.

Your rights under this limited warranty are not diminished if you do not complete and return the product registration form or complete and submit the online product registration form. Kramer Electronics thanks you for purchasing a Kramer Electronics product. We hope it will give you years of satisfaction.



**HDMI™**  
HIGH-DEFINITION MULTIMEDIA INTERFACE



P/N: 2900-301682



Rev: 7



#### SAFETY WARNING

Disconnect the unit from the power supply before opening and servicing

For the latest information on our products and a list of Kramer distributors, visit our website where updates to this user manual may be found.

We welcome your questions, comments, and feedback.

The terms HDMI, HDMI High-Definition Multimedia Interface, and the HDMI Logo are trademarks or registered trademarks of HDMI Licensing Administrator, Inc. All brand names, product names, and trademarks are the property of their respective owners.