



DIGITALINX
VALUE-ENGINEERED DIGITAL SOLUTIONS

DL-WFH-CAM90 Quick Install Guide



Product Overview

The DigitaLinx webcam DL-WFH-CAM90 is a leading USB 2.0 peripheral intended to capture audio and video for tasks such as video conferencing, streaming, webinars, on-line classes and personal chatting. Being truly plug-and-play, no driver is required when using software platforms such as Zoom, Teams, Youtube, Facetime and other messaging applications. Features include 1080p/30fps image sensor with a 90 degree field of view lens, tripod mount, security cap and built in microphone.

For advanced settings, download software from the Liberty AV website for image adjustments.

Package Contents

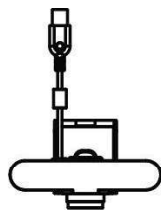

(x1) Camera

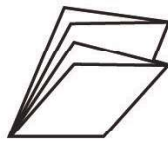

(x1) Quick Start Guide

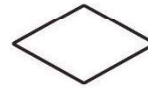

(x1) Quality Card

Product Layout

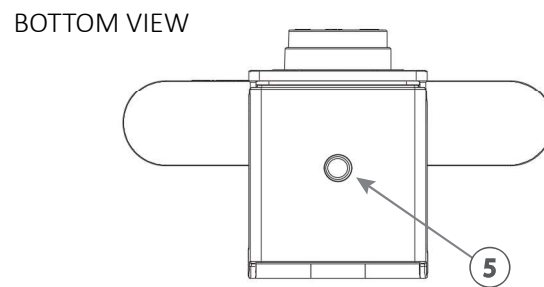
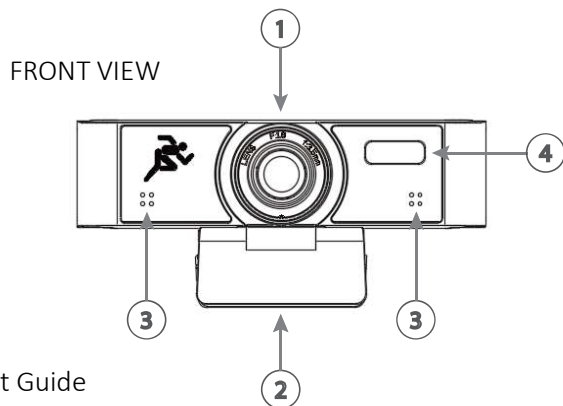

Start Guide

1. Lens
2. Flexible Clip-base
3. Noise reduction Microphone
4. Activity LED
5. Tripod Attachment- 1/4" thread for securing camera screw to mount or tripod
6. Security cover
7. USB cable with USB-A connector

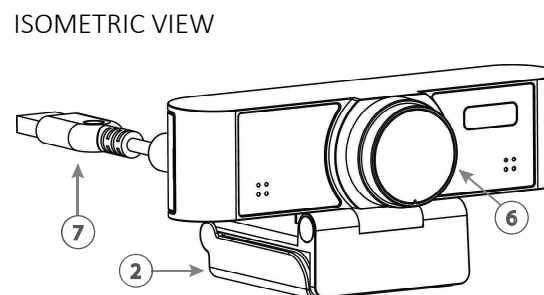

Setting up your webcam

Requirements- A computer with an audio output, preferably a speaker.

Install the video conferencing desktop client such as Zoom, Teams, Google meet onto the computer.

Note: verify your preferred video calling application requirements

Placement- When the monitor thickness is less than or equal to 45mm, the camera can be mounted above the

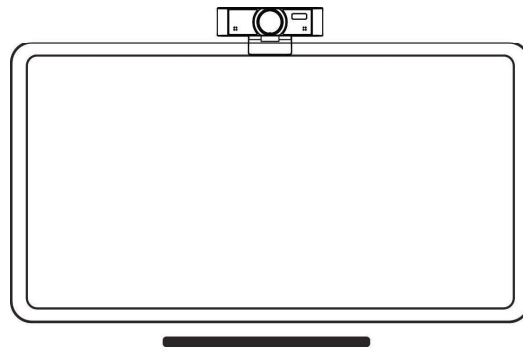

Connectivity- Locate the DL-WFH-CAM90 webcam and plug into the USB port of the computer. If the length of the USB cable is not long enough, use a TYPE A USB 2.0 extension cable or hub.

Navigation- *settings>privacy>camera* or similar within your PC and turn on 'let apps use my camera'

Close all other applications that may use the DL-WFH-CAM90 webcam.

Run the preferred software to use with the webcam.

Navigate to the "audio & video settings" within the software

Select "LibAV Cam90" in the Microphone drop down menu to receive excellent audio quality.

Select "LibAV Cam90" in the Camera drop down menu to receive excellent video quality

LED lights on the camera will light up to indicate the camera is running.

Maintenance and Troubleshooting

Maintenance

- If the camera is not in long-term use, please disconnect the power switch after use.
- Use soft cloth or cotton paper to remove dust from the camera housing.
- When cleaning the camera lens, please use dry soft cloth to wipe, if dirt is serious, use neutral cleaner gently. Do not use strong or corrosive detergent, lest the lens scratch, affect the image effect.

Avoid

- Pointing the lens to the background of a large bright color, bright areas or reflective objects.
- The camera should not work under unstable lighting conditions, otherwise the image may flash.
- Do not use around facilities that can transmit high-power radio waves, such as television station or radio-transmitting station.

Troubleshooting

- If you find the image to be out of focus, wave your hand in front of the camera, the camera will automatically adjust the focus to the new state
- Computer software doesn't detect the webcam-
 - Step 1: make sure that any other applications that are using the camera are fully closed
 - Step 2: within the software of your choice, go into the "audio & video settings"
 - Select "LibAV Cam90" in the Microphone drop down menu
 - Select "USB Live Camera" in the Camera drop down menu.
 - Step 3: make sure the USB drivers on your computer are up to date
- Computer hardware doesn't detect the webcam-
 - Step 1: reconnect the cameras USB cable to your computer
 - Step 2: restart your computer

Technical Specifications

Camera	
Sensor	1/2.7", CMOS, Effective Pixel: 2.07M
Scanning Mode	Progressive
Lens Mount	M12
Lens 1	Focus: f=3.2mm, FOV: 90°
Lens 2	Focus: f=3.5mm, FOV: 84° (Supports Autofocus)
Minimal Illumination	0.5 Lux @ (F2.0, AGC ON)
Shutter	1/30s ~ 1/10000s
White Balance	Auto, Manual, VAR
Camera bracket	Bracket with damper
Digital Noise Reduction	2D, 3D digital noise reduction
Back-light Compensation	Support
Features	
Operate System	Windows®7 (1080p and under only), Windows 8.1, Windows 10 or higher macOS™ 10.10 or higher Google™ Chromebook™ Version 29.0.1547.70 or higher Linux
Video Format	1080p@30fps/25fps, 720p@30fps/25fps, 960x540p@30fps/25fps, 640x360p@30fps/25fps
Color / Compression	MJPEG/YUY2/H.264
Resolution	MJPEG: 1920x1080 (default), 1600x896, 160x120, 176x144, 320x240, 352x288, 640x480, 720x576, 1280x720, 1024x768, 1024x576, 960x540, 848x480, 800x600, 800x448, 640x360, 480x272, 424x240, 320x180 YUY2: 1920x1080 (default), 160x120, 176x144, 320x240, 352x288, 640x480, 1280x720, 960x540, 640x360, 480x272, 424x240, 320x180 H.264: 1920x1080 (default), 1600x896, 160x120, 176x144, 320x240, 352x288, 640x480, 720x576, 1280x720, 1024x768, 1024x576, 960x540, 848x480, 800x600, 800x448, 640x360, 480x270, 424x240, 320x180
USB Communication Protocol	UVC 1.1
Input/Output Interface	
USB Interface	1 x USB 2.0: Type A
Physical Parameter	
Input Voltage	5V (USB power supply)
Current Consumption	200mA
Operating Temperature	0°C ~ 40°C (32°F ~ 104°F)
Storage Temperature	-40°C ~ 60°C (-40°F ~ 140°F)
Power Consumption	1W
Dimension (W*H*D)	118mm x 37.2mm x 30.8mm (without bracket)
Net Weight	93 Kg (without bracket)
MTBF	>30000h
Certification	CE, FCC, RoHS

Thank you for your purchase.

For Technical Support please call our toll free number at
800-530-8998 or email us at supportlibav@libav.com

www.libav.com

Digitalinx is a brand of:



LIBERTY
AV SOLUTIONS

11675 Ridgeline Drive
Colorado Springs, Colorado
80921 USA
Phone: 719-260-0061
Fax: 719-260-0075
Toll-Free: 800-530-8998