

# OIP-D50C

## AVoIP Controller

User Manual - English



[Important]

To download the latest version of Quick Start Guide, multilingual user manual, software, or driver, etc., please visit Lumens <https://www.MyLumens.com/support>

# Table of Contents

<b>Chapter 1</b>	<b>Package Contents .....</b>	<b>2</b>
<b>Chapter 2</b>	<b>Instruction before installation.....</b>	<b>3</b>
2.1	Selecting Switch .....	3
2.2	Bandwidth Calculation.....	3
<b>Chapter 3</b>	<b>Product Overview.....</b>	<b>4</b>
3.1	System Requirements.....	4
3.2	I/O functions Introduction.....	4
3.3	Remote Control .....	5
3.4	IR Pin Assignment.....	5
3.5	RS-232 Pin and Default Setting .....	5
<b>Chapter 4</b>	<b>Installation and Connections .....</b>	<b>6</b>
4.1	Connection diagram.....	6
4.2	Connection Setting.....	6
<b>Chapter 5</b>	<b>Start Using .....</b>	<b>7</b>
5.1	Switch Setting .....	7
<b>Chapter 6</b>	<b>WebGUI Control .....</b>	<b>8</b>
6.1	WebGUI Control Descriptions .....	8
6.2	WebGUI Control Menu Descriptions .....	9
<b>Chapter 7</b>	<b>Troubleshooting.....</b>	<b>22</b>
<b>Chapter 8</b>	<b>Safety Instructions.....</b>	<b>23</b>
	<b>Copyright Information.....</b>	<b>24</b>

# Chapter 1 Package Contents

---

**OIP-D50C Controller**



**Instruction for installation**

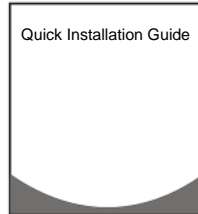

**Remote Control**



**5V/2.6A Power supply (including a multinational adapter)**



**3.5 mm to infrared extender**



**Foot mats**



**(A set of four)**

**Terminal block (90° 3pin)**



**Terminal block (90° 5pin)**



**Terminal block (180° 5pin)**



# Chapter 2 Instruction before installation

---

## 2.1 Selecting Switch

Recommended Brand/Model

Brand	Model	Brand	Model
NETGEAR	S3300 Series	ZyXEL	GS1920
NETGEAR	M4300 Series	ZyXEL	GS2210
D-Link	DGS-1510	ZyXEL	XS3700
Cisco	Catalyst 2960-X	Dell	PowerConnect 5524
EtherWAN	EX26262F	Dell	PowerConnect 2816

## 2.2 Bandwidth Calculation

- The table below summarizes the network bandwidth required for setting resolutions before installation as a reference

Resolution	Image Quality Settings	Maximum Frame Rate	Average Network Bandwidth (Mbps)
3840*2160 (2160p30)	Auto	30	218 (146~268)
1920*1080 (1080p)	Auto	60	133 (80~210)
1280*720 (720p)	Auto	60	147 (112~177)
1600*1200 (UXGA)	Auto	60	81 (57~105)
1280*1024 (SXGA)	Auto	60	113 (79~150)
1024*768 (XGA)	Auto	60	81 (72~120)
800*600 (SVGA)	Auto	60	66 (49~82)
640*480 (VGA)	Auto	60	43 (29~56)

# Chapter 3 Product Overview

## 3.1 System Requirements

- An effective network connection provided by a switch or router, used to connect this product and a compatible VoIP extender (including encoder and decoder).
- An HDMI audio and video equipment, such as a HD TV or screen.

## 3.2 I/O functions Introduction

### 3.2.1 Front panel



NO.	Item	Function Descriptions
①	Power indicator	When this light is on, the product is turned on and connected to the power supply.
②	IR receive window	It only receives the IR signals from the remote control of this product.

### 3.2.2 Rear panel

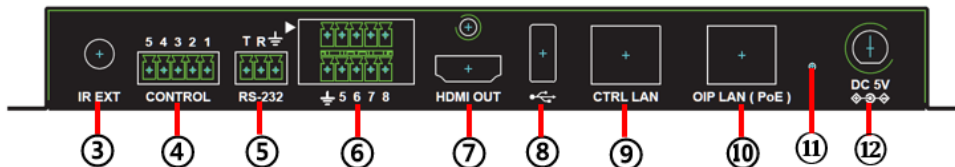

NO.	Item	Function Descriptions
③	IR input port	Connect an IR extender to extend IR to remote devices.
④	RS-232/RS-422/RS-485 output port	Not supported yet, it is expected to be activated through firmware update in the future.
⑤	RS-232 input port	This product can be operated via RS-232.
⑥	Contactor input port	Connect to other devices with contactor switch functions, such as window alarms and door switches. It can receive up to 8 contactor signals.
⑦	HDMI output port	It can connect to an HDMI display.
⑧	USB port	It can connect a USB keyboard and mouse to operate the WebGUI control page. <b>&lt;Remark&gt;</b> Please connect the USB control device before turning on this product.
⑨	CTRL network port	A computer can operate this product via a network switch connect device.
⑩	OIP network port (PoE)	It can connect to a control encoder and decoder.
⑪	Reset-to-default button	Hold this button for 3 seconds to restart the device and restore the factory settings.
⑫	Power connector	Plug in the 5V DC power adapter to supply power.

### 3.3 Remote Control

Preset locations 1 ~ 8: Press any key to start the corresponding preset location of that



### 3.4 IR Pin Assignment

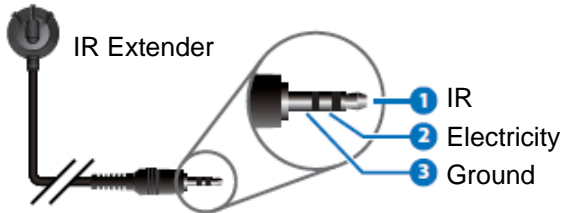

### 3.5 RS-232 Pin and Default Setting

Default Setting of the Serial Port	
Baud Rate	19200
Data Bit	8
Parity Bit	N
Stop Bit	1
Flow Control	N

#### ■ 3-pin Terminal Block

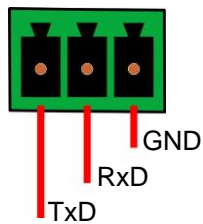

# Chapter 4 Installation and Connections

## 4.1 Connection diagram

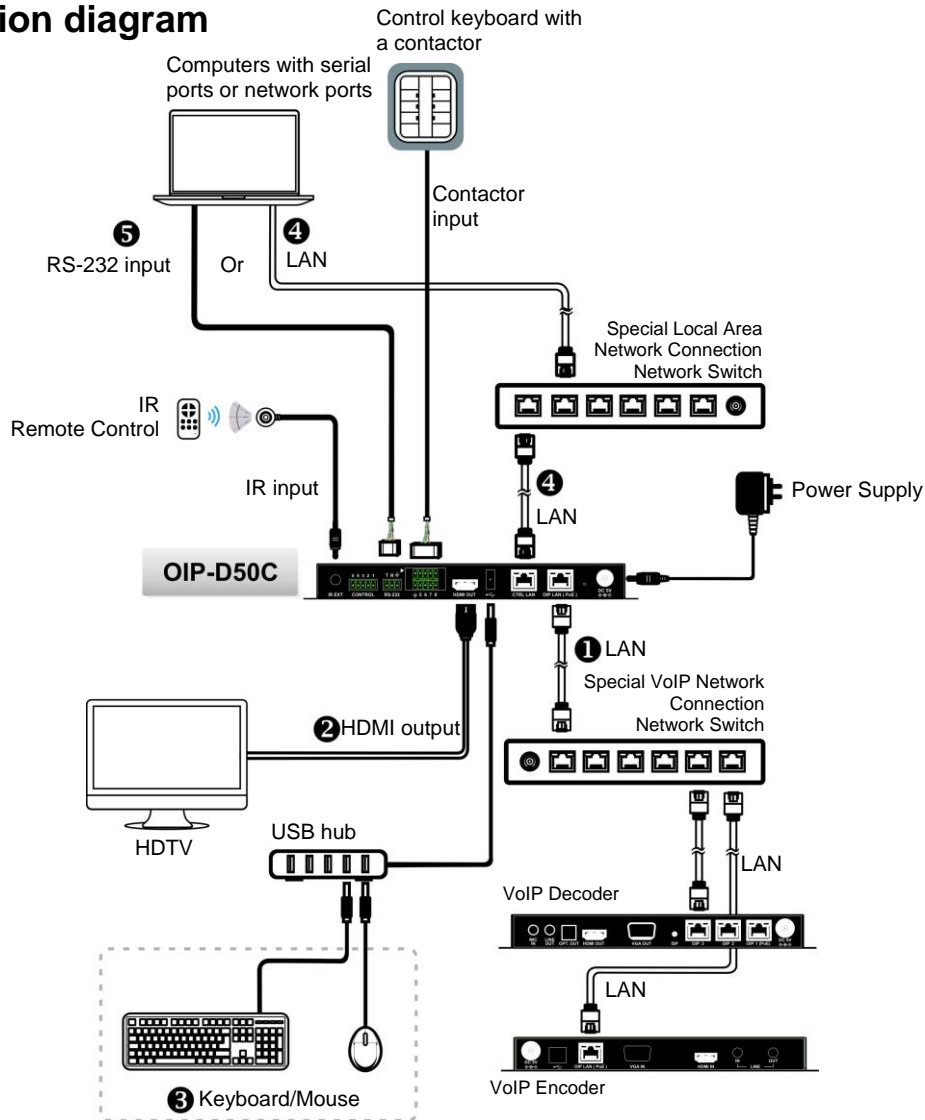

## 4.2 Connection Setting

This product needs to be equipped with a encoder and decoder at the same time. After the encoder and decoder are connected, connecting to this product can manage multiple encoders and decoders through the WebGUI control page.

- ① Connect the network switch of the same domain as the encoder and decoder to the OIP network port, so that all OIP devices are in the same local area network.
- ② Connecting to a HDMI display can check the device status message and access the WebGUI control page without computer.
- ③ Connect to USB keyboard and mouse.

After completing the above steps, you can use the keyboard and mouse to operate the WebGUI control page for operations and settings. You can also follow the steps below to control this product through computer:

- ④ Connect the CTRL network port to the network switch of the same domain as the computer, so that the D50C controller and the computer are in the same local area network. Enter the IP address of the controller in the web browser to operate and control the product on the web page.
- ⑤ Use a 3-pin terminal block to DE-9 terminal cable to connect to a desktop, notebook, or other serial main control devices, to perform operation through RS-232.

# Chapter 5 Start Using

---

## 5.1 Switch Setting

### ■ Notes

VoIP transmission will consume a lot of bandwidth (high resolutions), and it needs to be paired with a Gigabit network switch that supports Jumbo Frame and IGMP (Internet Group Management Protocol) Snooping. It is strongly recommended to be equipped with a switch which includes VLAN (Virtual Local Area Network) professional network management.

Most consumer-grade routers cannot handle the high traffic flow generated by multicast, so it is not recommended to directly use the router as your network switch. It is strongly recommended to avoid mixing your commonly used network traffic with VoIP streaming flow. VoIP streaming flow should at least use a separate subnet.

### ■ Setting Suggestions

- Please set Port Frame Size (Jumbo Frame) to 8000.
- Please set IGMP Snooping and relevant settings (Port, VLAN, Fast Leave, Querier) to **[Enable]**.



# Chapter 6 WebGUI Control

## 6.1 WebGUI Control Descriptions

### 6.1.1 Control by Connecting a Display

Connect the display to the HDMI output port as well as the keyboard and mouse to the USB port to see the unlogged WebGUI control page as shown in the figure below. For detailed menu descriptions, please see [6.2 WebGUI Control Menu Descriptions](#).

### 6.1.2 Control via a Web Browser

Open a web browser on the computer and enter the IP address of the CTRL LAN port to see the unlogged WebGUI control page as shown in the figure below. For detailed menu descriptions, please see [6.2 WebGUI Control Menu Descriptions](#).

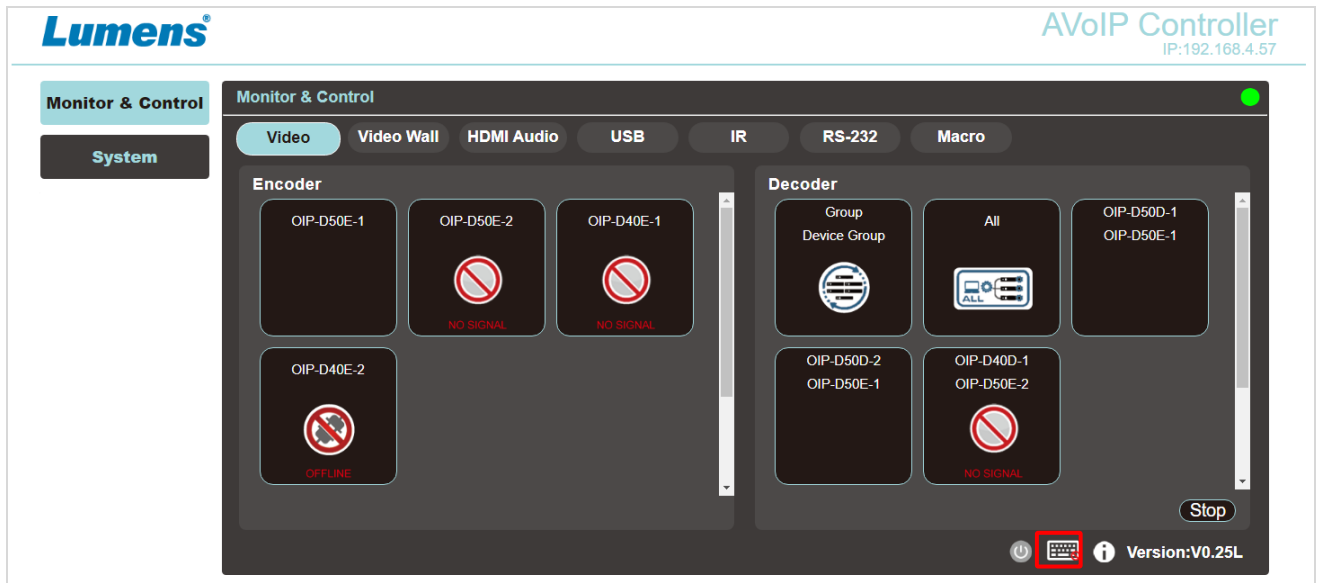

Even if the user has not logged in, the user can still operate some tabs (Monitor & Control, System). On the one hand, it allows users to change the existing I/O settings or preset I/O settings at any time. It also protects other sensitive and critical settings and configuration for you. To log in to the WebGUI control page, please go to the System tab and click the login button. The default user name and password are both “admin”. If you control the device with a display but without a keyboard, click the keyboard icon  in the lower right corner to open the keyboard and type in the user name and password.

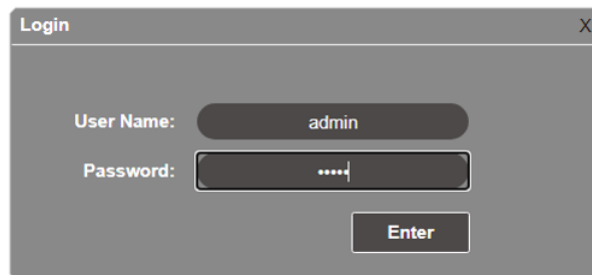

**<Remark>** If you are not sure about the IP address of the CTRL LAN port, please connect the HDMI display and check the message on the screen.

## 6.2 WebGUI Control Menu Descriptions

### 6.2.1 Monitor & Control - Image

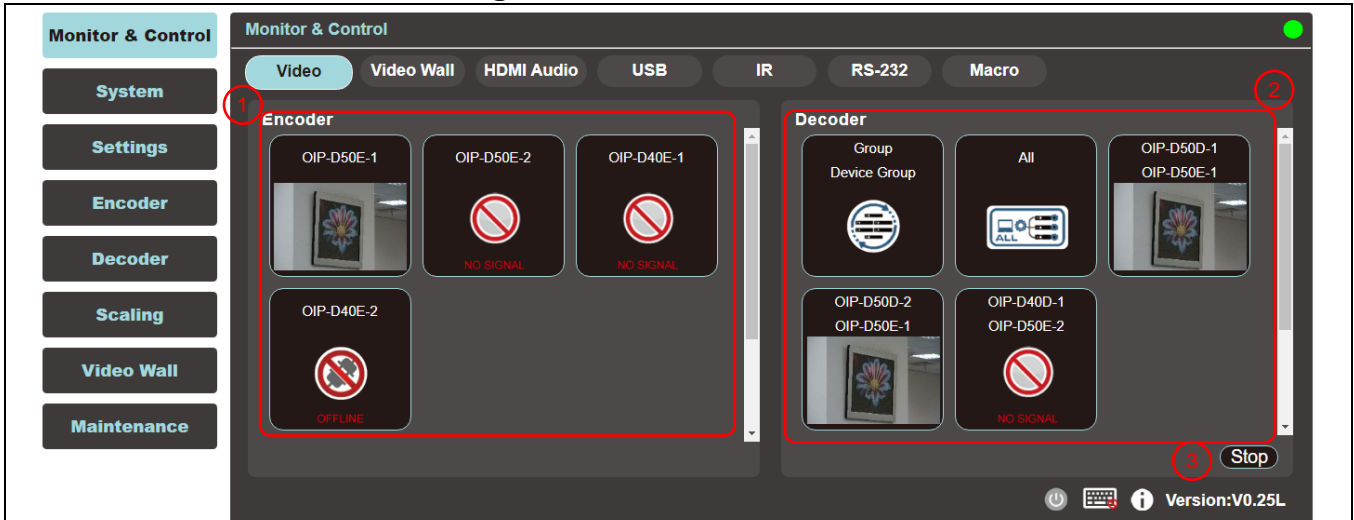

#### Description

This tab is to preview the encoder, decoder, and video area in the connection, and you can use drag and drop to change the signal settings.

No	Item	Function Descriptions
1	Preview of Encoder Signal Source	Drag and drop to assign signal sources to different decoders or groups.
2	Preview of Decoder Video Area	Display the preview thumbnail of the decoder signals, including the currently available display groups.
3	Stop	Drag an object to this button and release to stop setting the object.

- The thumbnail of the image source will be displayed under normal conditions, and the status icon will be displayed under the following conditions:

	When the encoder is not currently connected to the input source.		When the encoder or decoder does not support image thumbnails.
	When the encoder or decoder is disconnected or not detected by the main controller.		

### 6.2.2 Monitor & Control – Video Wall

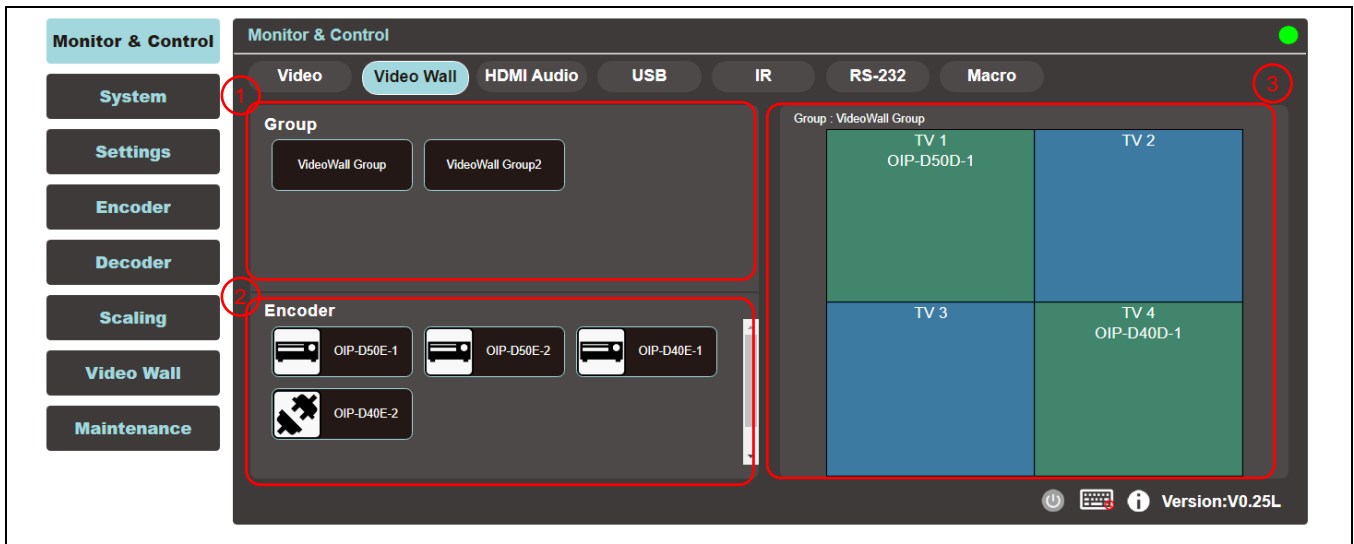

No	Item	Function Descriptions
1	Group	Show all current VideoWall groups
2	Encoder	Show all encoders, drag the encoder to the upper VideoWall group, and assign the source to that VideoWall group.
3	Group View	Green for assigned sources, and blue for unassigned or not connected to the source.

### 6.2.3 Monitor & Control - HDMI Audio

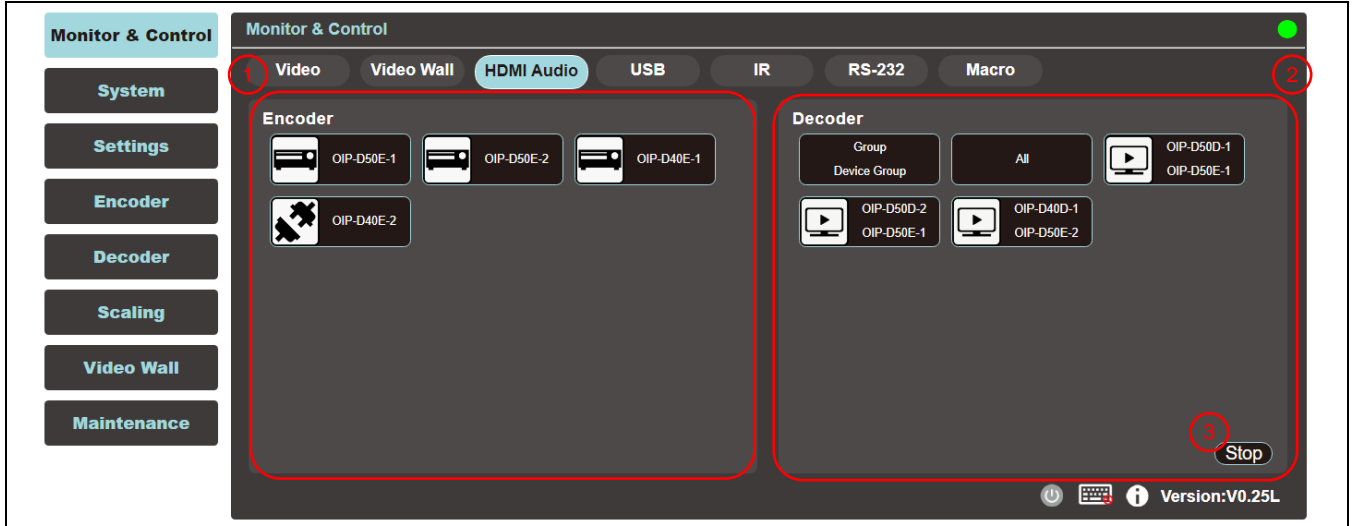

No	Item	Function Descriptions
1	Encoder	Show all current encoders. To assign HDMI audio sources to different decoders or groups, drag and drop the encoder to the decoder or group to be set. Click an encoder pane, and the corresponding decoder panes that receive the encoder signals will all change their color.
2	Decoder	Displays all current decoder, and also the name of the source signal encoder.
3	Stop	Drag the object to the <b>[Stop]</b> button and release to stop setting the object.

### 6.2.4 Monitor & Control - USB

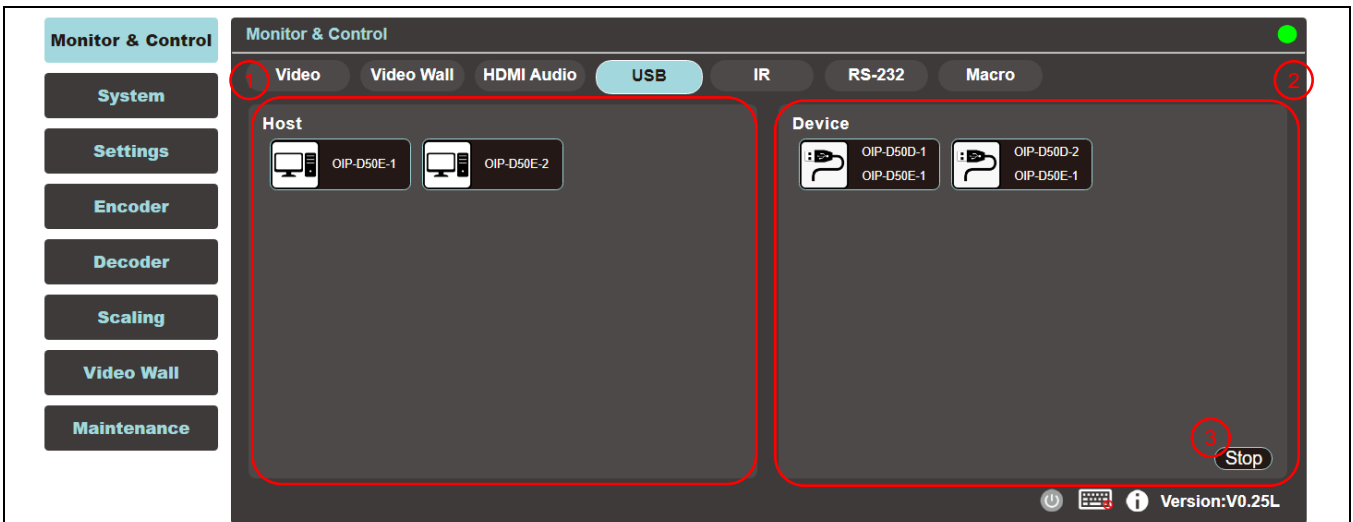

No	Item	Function Descriptions
1	Host	Display all current USB hosts (computers, laptops).
2	Device	It can be dragged to the USB host pane to complete the pairing.
3	Stop	Drag the object to the <b>[Stop]</b> button and release to stop setting the object.

## 6.2.5 Monitor & Control - IR

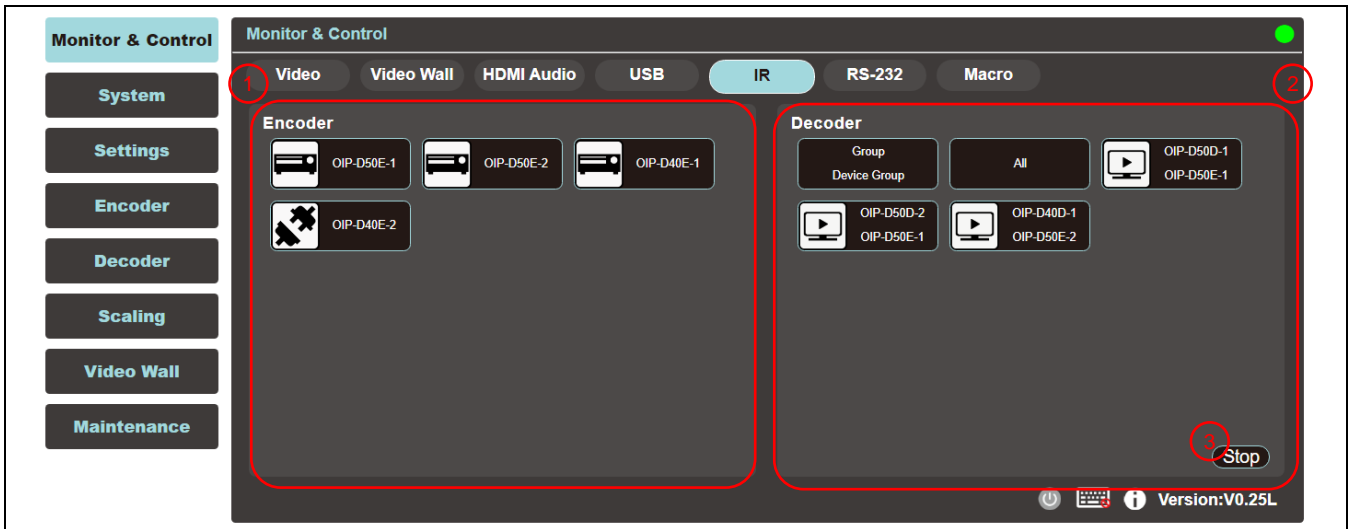

No	Item	Function Descriptions
1	Encoder	Show all current encoders with IR ports.
2	Decoder	Drag the encoder to the decoder pane to complete the device pairing.
3	Stop	Drag the object to the <b>[Stop]</b> button and release to stop setting the object.

## 6.2.6 Monitor & Control - RS-232

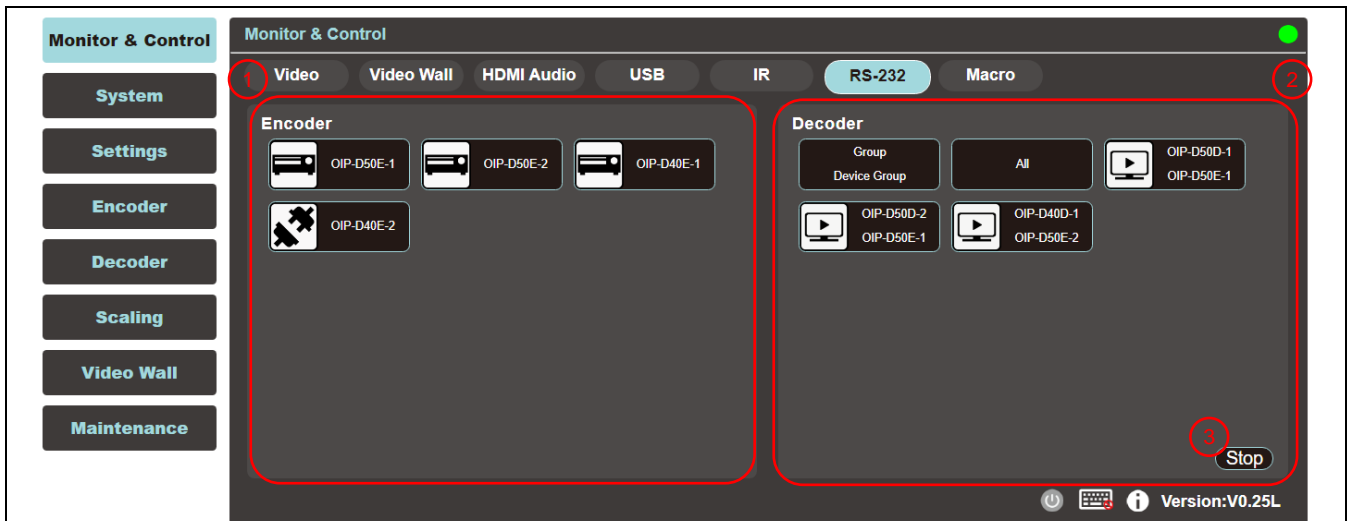

No	Item	Function Descriptions
1	Encoder	Show all current encoders with RS-232 port.
2	Decoder	The encoder can also be dragged to the decoder pane to complete the pairing.
3	Stop	Drag the object to the <b>[Stop]</b> button and release to stop setting the object.

## 6.2.7 Monitor & Control - Macro

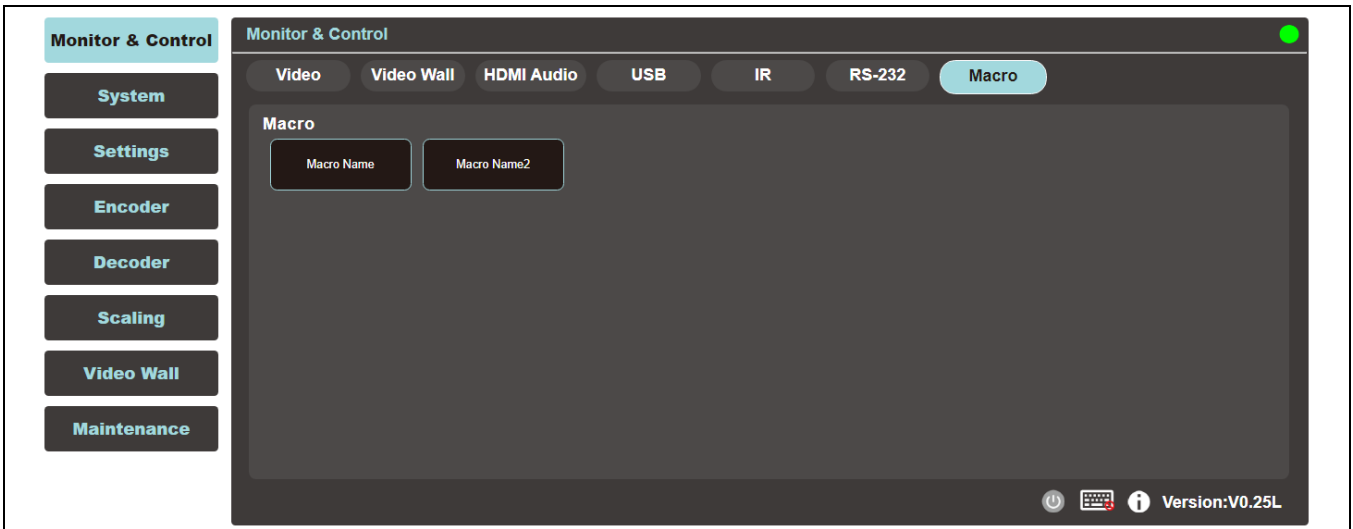

### Description

Display the name of the currently set macro. Click to execute the set macro. Before the macro setting is completed, the button will remain blue. Only one macro can be executed at the same time.

## 6.2.8 System

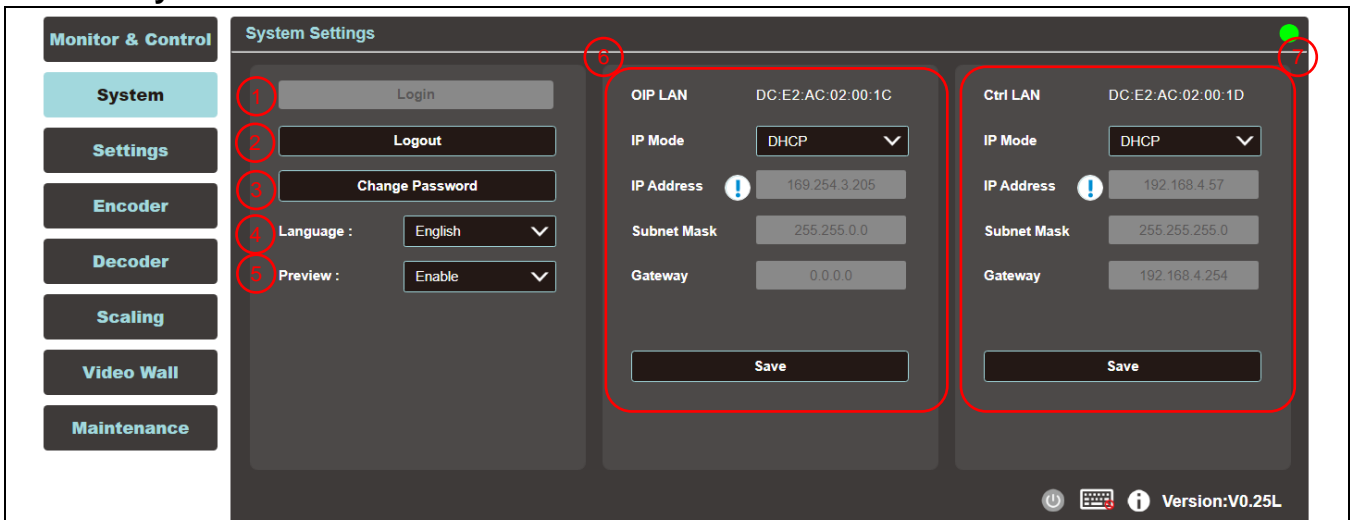

### Description

This tab can access each system setting, including LAN settings and login and user management.

No	Item	Function Descriptions
1	Login	Default username and password are both [admin].
2	Logout	Click Logout button to log out <b>WebGUI</b> control page.
3	Change the password	Click Change Password button to change the password of the <b>WebGUI</b> administrator.
4	Change the Language	Open the drop-down menu to change the language to English/Chinese (Traditional)/Chinese (Simplified).
5	Preview Thumbnails	Open the drop-down menu to enable/disable preview thumbnails.
6	OIP LAN	Set OIP LAN and Ctrl LAN.
7	Ctrl LAN	

## 6.2.9 Settings - Group

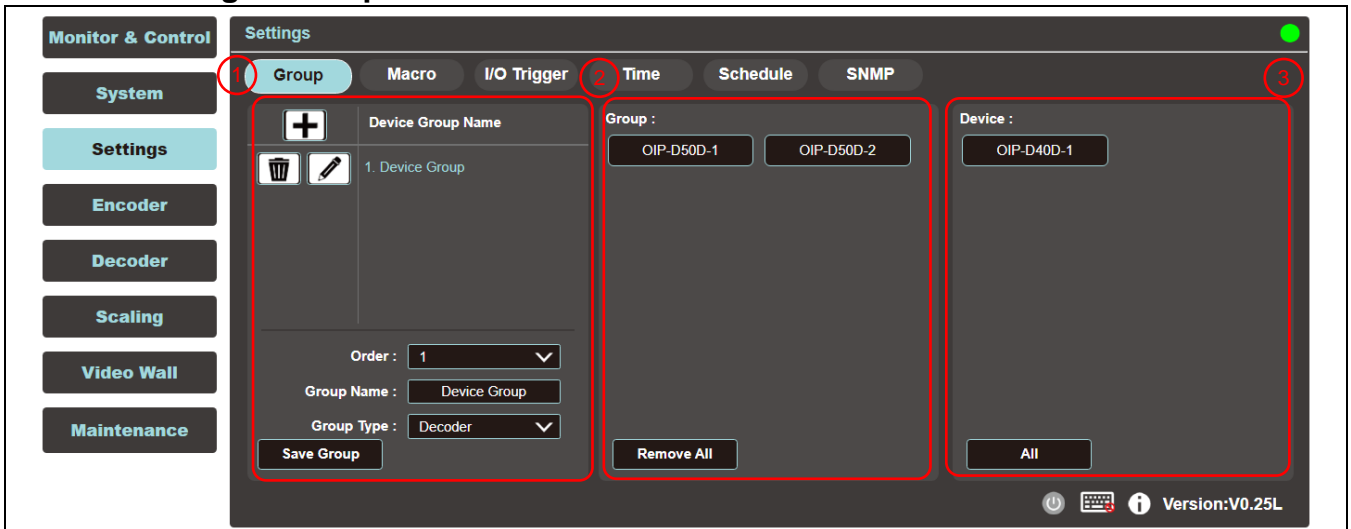

No	Item	Function Descriptions
1	Device Group List	Show the currently set group list.
2	Group List	Show the decoders set by the selected group.
3	Device List	Show all available decoder devices.

## 6.2.10 Settings - Macro

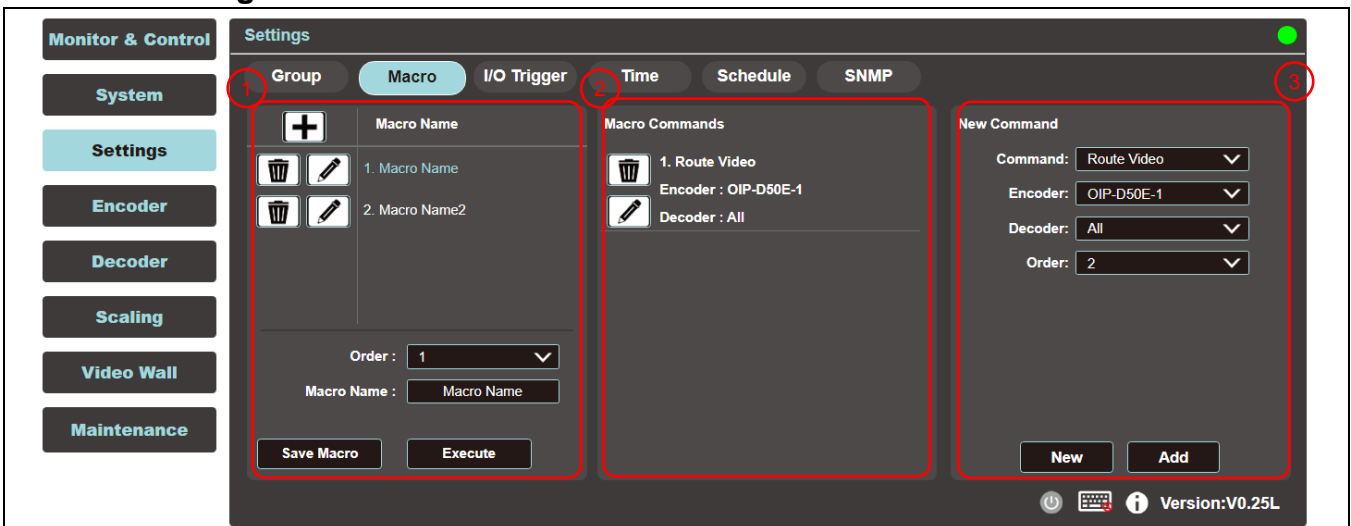

### Description

This tab provides a way to create operation commands, which can be controlled by an external IR remote control, trigger, or from within the WebGUI. It can set a maximum of 16 macros, and each macro can contain up to 64 commands.

No	Item	Function Descriptions
1	Macro List	Show the currently set macro list.
2	Macro Commands Table	Show the commands list set in the currently selected macro.
3	New Command Setting	The new commands can be added here.

## 6.2.11 Settings - I/O Trigger

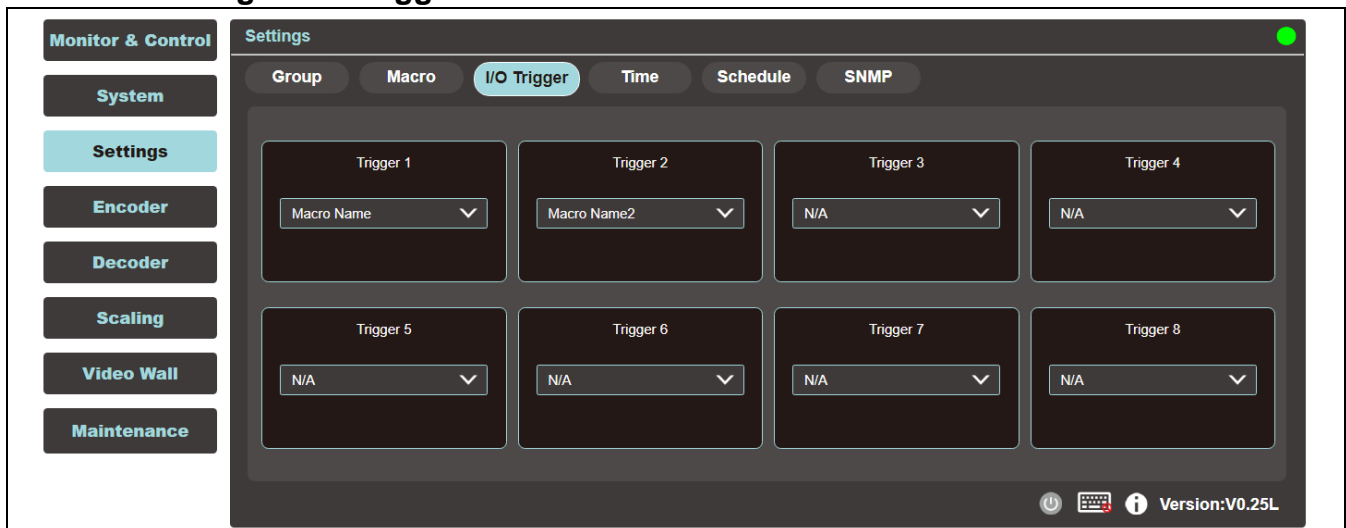

### Description

This tab can set the macro to be triggered by the contactor. There are 8 buttons to be set. This setting also applies to the IR remote control buttons.

## 6.2.12 Setting - Time

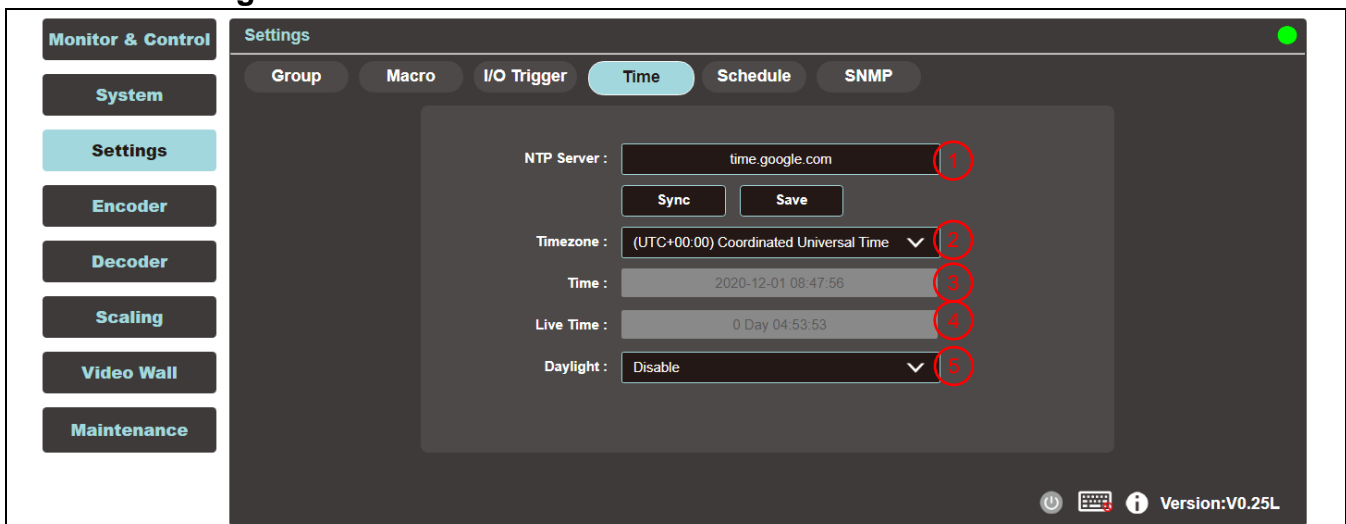

No	Item	Function Descriptions
1	NTP Server	Enter the host name or IP address of the preferred NTP server for time synchronization. After changing the NTP server, click [Save] to save the settings. Click [Sync] to force the device to synchronize to the NTP server immediately. <b>&lt;Remark&gt;</b> The clock of this device has no backup battery, and the time setting will not be preserved if the device is unplugged. But as long as both the Internet connection and the NTP server are valid, the time setting will be automatically synchronized when the power is on.
2	Time zone	Open the drop-down menu to select the time zone for your region.
3	Time	Show the current device time.
4	Live Time	Show how long the device has been online since the last restart.
5	Daylight	Select to enable/disable Daylight.

### 6.2.13 Settings - Schedule

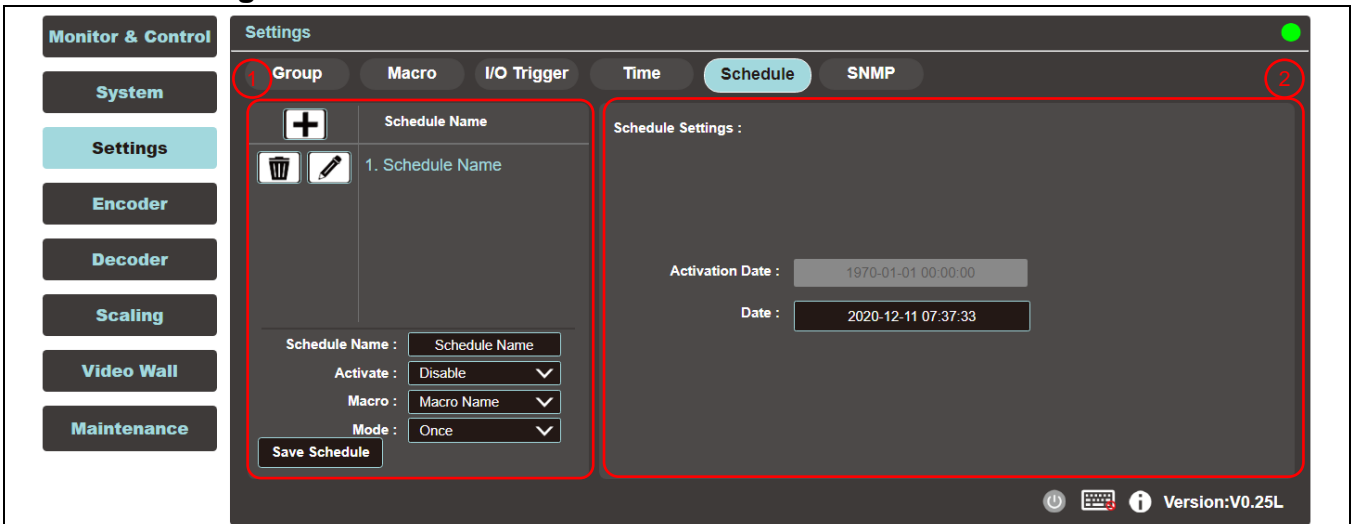

No	Item	Function Descriptions
1	Schedule List	Show the currently set schedule list.
2	Schedule Settings	Show the schedule settings in different modes based on the set time mode. (Once/repeat/cycle) In repeat mode, enter "0" in the frequency field to repeat indefinitely.

### 6.2.14 Settings - SNMP

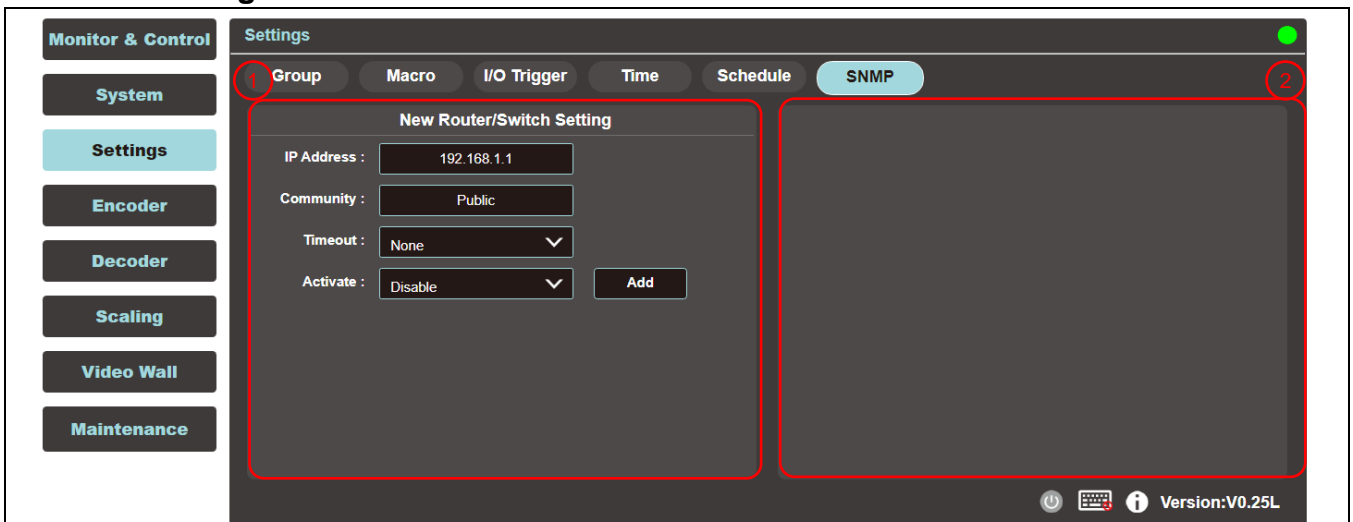

No	Item	Function Descriptions
1	Router/Switch Settings	Enter the router or switch connection information to view its status and bandwidth usage.
2	Information Window	Use SNMP to connect to a router or switch. The device shows green to indicate that the port is connected, white to indicate that the port can be connected, and red to indicate an error. Move the cursor to the port to display the related message.



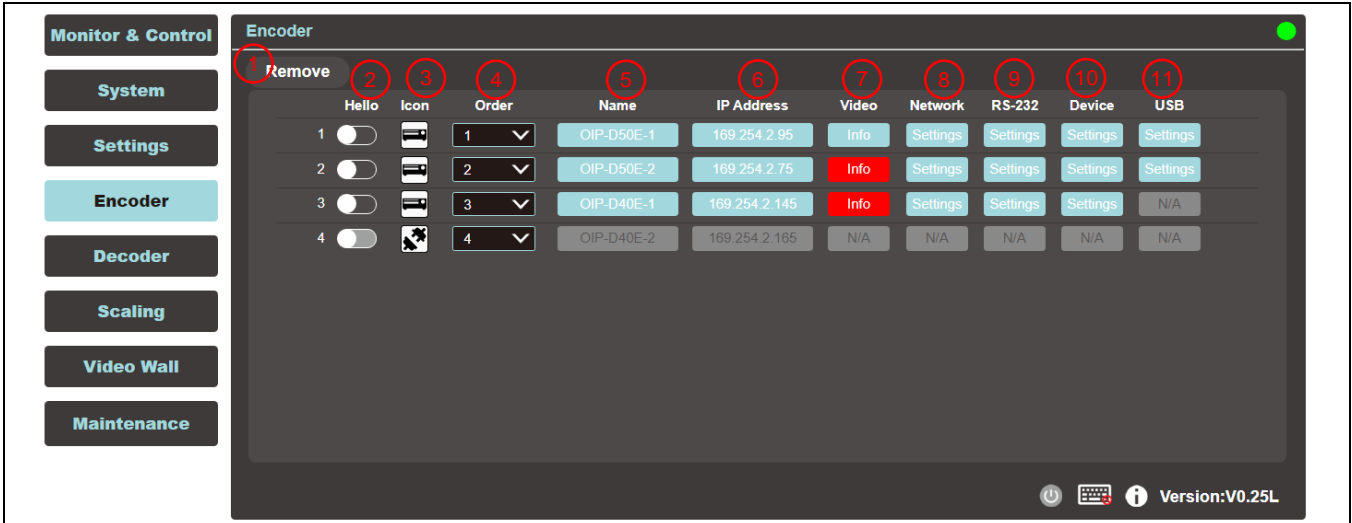

## 6.2.15 Encoder



### Description

This tab displays all the encoders that have been detected, and also shows the detailed data and related settings of each encoder.

**<Remark>** If there is no available image source, the Image button will be red. Gray “N/A” means that the function is not supported.

No	Item	Function Descriptions
1	Remove	It can remove unconnected encoder (marked  ).
2	Hello	After clicking, the LED indicator on the front panel of the encoder flashes immediately, making it easier to find the encoder. Click this button again to restore the normal operation of the LED indicator.
3	Icon	Show the icon that represents the encoder.  for connected;  for unconnected.
4	Order	It can select the order of each encoder.
5	Name	Show the name of the encoder. Click Device > [Settings] to enter 12 letters or numbers to change its name.
6	IP address	Show the IP address of the current encoder.
7	Video	Display the detailed information of the image input source. <b>&lt;Remark&gt;</b> If there is no image source, the button is red.
8	Network	Click the [ <b>Settings</b> ] button to display detailed network information. The default mode is Auto IP.
9	RS-232	Show the detailed information of the current RS-232 serial.
10	Device	Show the detailed information of the device. For detailed settings, please see <a href="#">6.2.16 Encoder - Device Settings</a> .
11	USB	Show the detailed information of the current USB, and the settings can be changed here. The default is Auto Select mode. K/M Over IP and USB HID URB interval: A special optimization function can be used to solve the abnormal response of the mouse or touch screen. You can choose to enable or disable it. The default setting is disabled.

## 6.2.16 Encoder - Device Settings

### Description

Show the message related to the setting of the encoder-end device. If the function drop-down menu is grayed out, the function has automatically detected the source, or the connected encoder does not support this function.

No	Item	Function Descriptions
1	Version	Show the current firmware version of the device
2	System Command	Select System Command to reset or restart the device
3	Name	Change the device name (12 characters at most)
4	Channel Select	Select the broadcast channel of the encoder. Available range: 0 ~ 255. <Remark> Each encoder in the same LAN needs to be allocated to different broadcast channels to avoid conflicts.
5	Multicast On	Select to enable multicast mode when broadcasting, or use unicast mode when disabled <Remark> The decoder needs to use the same mode as the encoder to receive image.
6	Video Type	Select the image input source on the device to be played.
7	Maximum Frame Rate	Set the maximum frame rate, available range: 0 ~ 60.
8	Bandwidth	Set the maximum bandwidth for the image, available range: Unlimited/400M/200M/100M/50M. <Remark> When the input source is 4K image, although the recommended setting is Unlimited, the bandwidth may be very big, which will limit the number of simultaneous image streams.
9	Audio Source	Select the audio source, available options: HDMI/Line in/Auto <Remark> This setting is stored independently for individual input sources, and the default setting is Auto.
10	Audio Mute	This feature is currently not supported.
11	Audio Volume	This feature is currently not supported.
12	Auto Scan	The device will search the input signal (HDMI/VGA) automatically after this feature is enabled.
13	Front Panel Lock for Device Button	This feature is currently not supported.
14	Front Panel Lock for Device Knob	This feature is currently not supported.

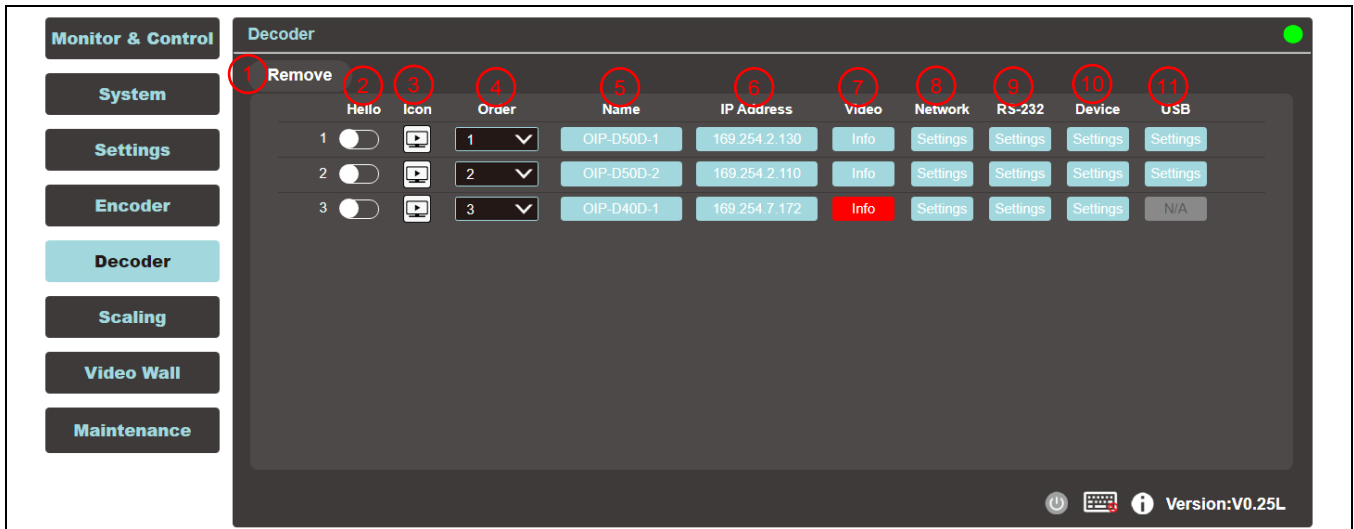

## 6.2.17 Decoder



### Description

Show detailed data and related settings of all decoders.

**<Remark>** If there is no available image source, the Image button will be red, and gray "N/A" means that the function is not supported.

No	Item	Function Descriptions
1	Remove	It can remove unconnected decoder (marked  )
2	Hello	After clicking, the LED indicator on the front panel of the decoder flashes immediately, making it easier to find the decoder. Click this button again to restore the normal operation of the LED indicator.
3	Icon	Show the icon that represents the decoder.  for connected;  for unconnected.
4	Order	It can select the order of each decoder.
5	Name	Show the name of the decoder. Click Device > [Settings] to enter 12 letters or numbers to change its name.
6	IP address	Show the IP address of the current decoder.
7	Video	Display the detailed information of the image input source. <b>&lt;Remark&gt;</b> If there is no image source, the button is red.
8	Network	Click the decoder [Settings] button to display detailed network information. The default mode is Auto IP.
9	RS-232	Show the detailed information of the current RS-232 serial.
10	Device	Show the detailed information of the decoder. For detailed settings, please see <a href="#">6.2.18 Decoder - Device Settings</a> .
11	USB	Show the detailed information of the current USB, and the settings can be changed here. The default is Auto Select mode. K/M Over IP and USB HID URB interval: A special optimization function can be used to solve the abnormal response of the mouse or touch screen. You can choose to enable or disable it. The default setting is disabled.

## 6.2.18 Decoder - Device Settings

### Description

Show the message related to the setting of the decoder-end device. If the function drop-down menu is grayed out, the function has automatically detected the source, or the connected decoder does not support this function.

No	Item	Function Descriptions
1	Version	Show the current firmware version of the device.
2	System Command	Select System Command to reset or restart the device.
3	Name	Change the device name (12 characters at most).
4	Multicast On	Select to enable or disable the multicast mode when broadcasting. When this function is disabled, the unicast mode will be used for transmission. <b>&lt;Remark&gt;</b> The decoder needs to use the same mode as the encoder to receive image.
5	Video Channel Lock for Device Button	When this setting is enabled, the image channel selection button will be locked and cannot be used.
6	Video Select Lock for Device Button	When this setting is enabled, the image input selection button will be locked and cannot be used.
7	Video Linkage Route	After selecting Enable, when the user switches the signal source, the image will switch as well.
8	Audio Linkage Route	After selecting Enable, when the user switches the signal source, the audio will switch as well.
9	IR Linkage Route	After selecting Enable, when the user switches the signal source, IR will switch as well.
10	Video Source Unavailable Timeout	When the signal source is disconnected, the original screen will remain at the time set by the user temporarily, and then display OSD information (encoder/decoder IP, FW version, connection status). Available range: 3 sec/5 sec /10 sec /20 sec /30 sec /60 sec /Never
11	Video Turn Off Screen On Power Save	After the setting is enabled, when the signal source is disconnected, the original screen will remain for the time set by the user temporarily, and then the display will enter the Power save mode. After the setting is disabled, the screen will keep showing "Lost Connection" until the connection is restored.
12	Copy EDID From Sink	When multiple decoders are connected to a single encoder in multicast mode, enabling this on one receiver selects which of the decoders should send its EDID to the encoder for use with the source. <b>&lt;Remark&gt;</b> This option is only valid in multicast mode.
13	Video Over IP	The default value is enabled. If it is disabled, image and audio cannot be transmitted through AV over IP technology. <b>&lt;Remark&gt;</b> This option should always remain enabled status, unless troubleshooting is being performed.
14	Audio Mute	This feature is currently not supported.

15	Audio Volume	This feature is currently not supported.
16	Front Panel Lock for Device Button	This feature is currently not supported.
17	Front Panel Lock for Device Knob	This feature is currently not supported.
18	Video Type	Select the image input source on the device to be played.
19	Video Wall	Click this button to create a new window to configure the settings of the current Video Wall of this decoder. For detailed setting content, please see <a href="#">6.2.20 Video Wall</a> .

### 6.2.19 Scaling

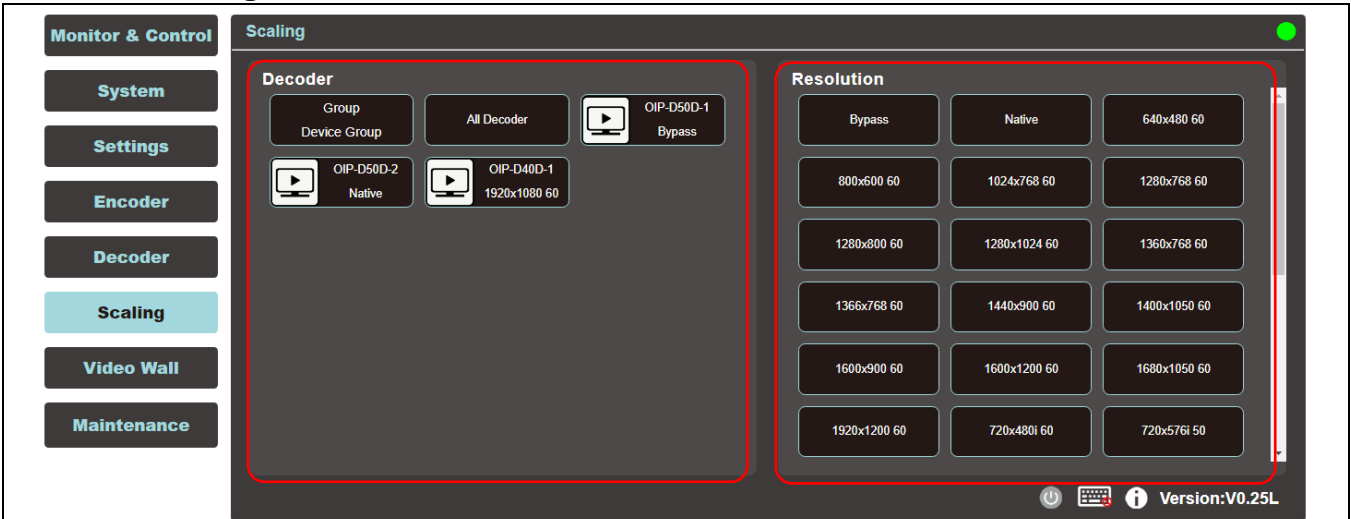

#### Description

This tab can set the image output resolution of each decoder.  
 Click the decoder to be set on the left, then drag it to the resolution to be set on the right and release it. After the setting is completed, the set resolution will be displayed under the decoder name. You can also directly drag and drop the resolution to the decoder button to change the output resolution.  
**Bypass:** The decoder will output all signals at its original resolution.  
**Native:** The decoder will use the resolution provided by the EDID of the connected display to output signals.

### 6.2.20 Video Wall

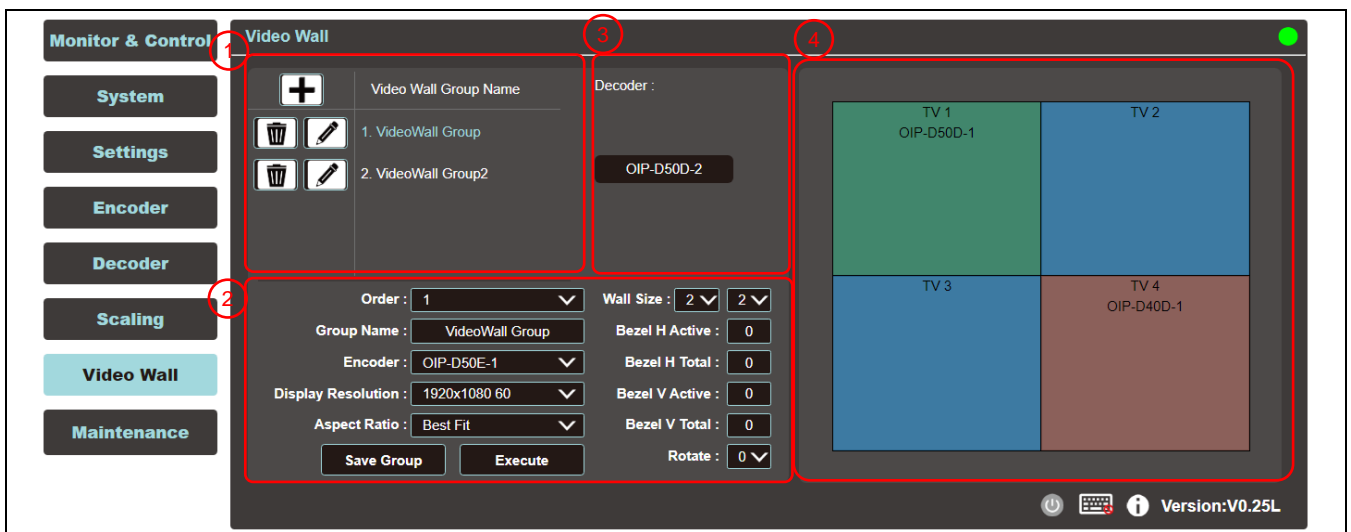

No	Item	Function Descriptions
1	VideoWall Group List	Show the currently set VideoWall group list.
2	Settings	Order: It can sort different VideoWall groups. Group Name: Set the name of a VideoWall group.

		Encoder: Set the image source. Display Resolution: You can select the Display Resolution of all decoders in this VideoWall group. Aspect Ratio: It can be set to [Full Screen] or [Best Fit]. Wall Size: Set the size of the Video Wall, and the maximum number of displays is 256 (16*16). Bezel H/V Total & H/V Active: Set the actual size of all displays in the Video Wall. <b>&lt;Remark&gt;</b> It is recommended that the displays in the Video Wall use the same brand and model to avoid the difference in the size of the frame and the panel. Rotate: Set the rotation angle of the image (0°/180°/270°)
3	Decoder	Show all currently available decoders. Place all decoders onto the Video Wall on the right.
4	VideoWall Preview	Display the preview image of the decoder currently assigned by the Video Wall. If the display on the Video Wall has been assigned, it will show the name of the assigned receiver.

### 6.2.21 Maintenance

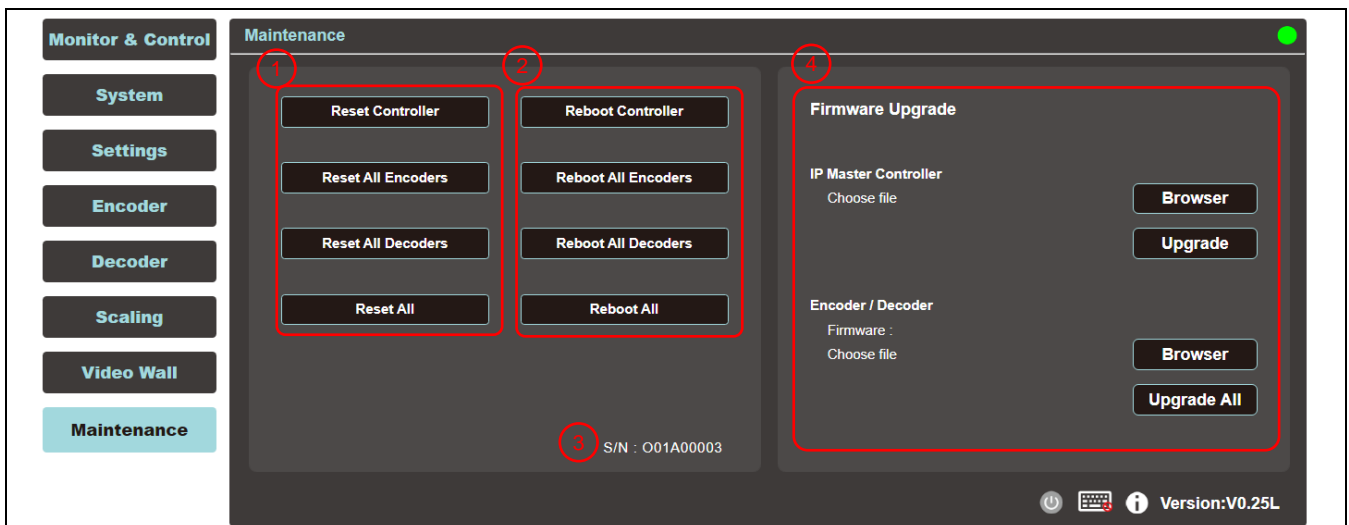

No	Item	Function Descriptions
1	Reset Controller	Reset will restore the device to its initial settings. Click on the option to reset all connected controllers, encoders, decoders, or all devices.
2	Reboot Controller	Reboot will restart the device, and all settings will be retained. Click the option to reboot all connected controllers, encoders, decoders, or all devices.
3	Serial No.	It shows the serial number of this connected controller.
3	Firmware Upgrade	You can update the firmware version of the controller, encoder, and decoder. Click [Choose File] and select the correct updated file (bin format) from the computer. After choosing the file, click [Upgrade] to start updating the program. Once the update is finished, the device will restart.

# Chapter 7 Troubleshooting

This chapter describes problems you may encounter while using OIP-D50C. If you have questions, please refer to related chapters and follow all the suggested solutions. If the problem still occurred, please contact your distributor or the service center.

No.	Problems	Solutions
1.	<b>The signal source screen is not shown on the display-end.</b>	<p>1. Please check whether the Multicast of the encoder and decoder is enabled: Enter the WebGUI control interface of the D50C controller, then click Device - [Settings] on the Encoder-end and Decoder-end tabs to check whether Multicast is enabled.</p> <p>2. Make sure the source is set to HDMI or VGA: (Only applicable to D50E/D50D)</p> <p>(1) Enter the WebGUI control interface of the D50C controller, and click Device - [Settings] on the Encoder-end tab to check that the Video type is set to HDMI or VGA.</p> <p>(2) On the front panel of the decoder host, press the Mode button to switch between HDMI and VGA signal sources.</p>
2.	<b>Image delay on the display-end</b>	<p>1. Check whether the MTU of the encoder and decoder is enabled (default is enabled): Enter "GET_JUMBO_MTU" in the Command field in the WebGUI interface system - Utility Program tab, and the Output below will show whether the status of jumbo frame MTU is enabled or disabled. If it is disabled, please enter "SET_JUMBO_MTU 1" in the Command field to enable it, and follow the instructions to restart the device to implement the changes.</p> <p>2. The streaming mode may be Graphic Mode: (Only applicable to D50E/D50D) On the front panel of the decoder host, press the Mode button to switch between the Video/Graphic modes. Please switch to the Video mode.</p>
3.	<b>The image on the display-end is broken or black</b>	<p>Check that the Jumbo Frame of the switch is set to above 8000; Please make sure that IGMP Snooping of the switch and relevant settings (Port, VLAN, Fast Leave, Querier) has been set to "Enable".</p>

<Remark> At least 5V DC current is required to activate the contactor.

# Chapter 8 Safety Instructions

Always follow these safety instructions when setting up and using this product:

## 1 Operation

- 1.1 Please use the product in the recommended operating environment, away from water or source of heat
- 1.2 Do not place the product on a tilted or unstable trolley, stand or table.
- 1.3 Do not open or remove covers, otherwise it may expose you to dangerous voltages and other hazards. Refer all servicing to licensed service personnel.



## 2 Storage

- 2.1 Do not place the product where the cord can be stepped on as this may result in fraying or damage to the lead or the plug.
- 2.2 Unplug this product during thunderstorms or if it is not going to be used for an extended period.
- 2.3 Do not place this product or accessories on top of vibrating equipment or heated objects.

## 3 Cleaning

- 3.1 Disconnect all the cables prior to cleaning and wipe the surface with a dry cloth. Do not use alcohol or volatile solvents for cleaning.

## ■ Precautions

	This symbol indicates that this equipment may contain dangerous voltage which could cause electric shock. Do not remove the cover (or back). No user-serviceable parts inside. Refer servicing to licensed service personnel.		This symbol indicates that there are important operating and maintenance instructions in this User Manual with this unit.
---	---	--	---

## ■ FCC Warning

This equipment has been tested and found to comply with the limits for a Class A digital device, pursuant to part 15 of the FCC Rules. These limits are designed to provide reasonable protection against harmful interference when the equipment is operated in a commercial environment.

Notice:

The changes or modifications not expressly approved by the party responsible for compliance could void the user's authority to operate the equipment.

This equipment has been tested and found to comply with the limits for a Class A digital device, pursuant to part 15 of the FCC Rules. These limits are designed to provide reasonable protection against harmful interference when the equipment is operated in a commercial environment.

## ■ IC Warning

This digital apparatus does not exceed the Class A limits for radio noise emissions from digital apparatus as set out in the interference-causing equipment standard entitled "Digital Apparatus," ICES-003 of Industry Canada.

Cet appareil numérique respecte les limites de bruits radioélectriques applicables aux appareils numériques de Classe A prescrites dans la norme sur le matériel brouilleur: "Appareils Numériques," NMB-003 édictée par l'Industrie.

## ■ EN55032 CE Warning

Operation of this equipment in a residential environment could cause radio interference.

Warning: Operation of this equipment in a residential environment may cause radio interference.



# Copyright Information

---

Copyrights © Lumens Digital Optics Inc. All rights reserved.

Lumens is a trademark that is currently being registered by Lumens Digital Optics Inc.

Copying, reproducing or transmitting this file is not allowed if a license is not provided by Lumens Digital Optics Inc. unless copying this file is for the purpose of backup after purchasing this product.

In order to keep improving the product, the information in this file is subject to change without prior notice.

To fully explain or describe how this product should be used, this manual may refer to names of other products or companies without any intention of infringement.

Disclaimer of warranties: Lumens Digital Optics Inc. is neither responsible for any possible technological, editorial errors or omissions, nor responsible for any incidental or related damages arising from providing this file, using, or operating this product.