

VS-KB21/ VS-KB21N Keyboard controller (Keyboard Controller)

User Manual – English



Ver. VY1101

[Important]

To download the latest version of Quick Start Guide, multilingual user manual, software, or driver, etc., please visit Lumens
<https://www.MyLumens.com/support>

Contents

Copyright Information	2
Chapter 1 Safety Instructions.....	3
Precautions	3
FCC Warning	3
Chapter 2 Product Overview	4
2.1 I/O Introduction	4
2.2 Panel function introduction	5
2.3 LCD screen display description	6
Chapter 3 LCD function menu description	7
3.1 Access LCD function menu	7
3.2 Hot Key Camera	7
3.3 Device Management	7
3.4 Network	7
3.5 KEYS	8
3.6 Display	8
3.7 Beep	8
3.8 Joystick	9
3.9 Tally	9
3.10 Language	9
3.11 Password Setting	9
3.12 Sleep Mode	9
3.13 About Device	9
3.14 Reset Device	9
Chapter 4 Camera connection	10
4.1 Port pin definition	10
4.2 How to Connect RS-232	10
4.3 How to Connect RS-422	11
4.4 How to Connect IP	11
Chapter 5 Web Interface	13
5.1 Connecting Camera to Network	13
5.2 Web Login	13
5.3 Web Page Functions	14
Chapter 6 Common Functions	21
6.1 Call the camera	21
6.2 Setup/call/cancel preset position.	21
6.3 Set the camera OSD menu via the keyboard	22
Chapter 7 Troubleshooting.....	23

Copyright Information

Copyrights © Lumens Digital Optics Inc. All rights reserved.

Lumens is a trademark that is currently being registered by Lumens Digital Optics Inc.

Copying, reproducing or transmitting this file is not allowed if a license is not provided by Lumens Digital Optics Inc. unless copying this file is for the purpose of backup after purchasing this product.

In order to keep improving this product, Lumens Digital Optics Inc. hereby reserves the right to make changes to product specifications without prior notice. The information in this file is subject to change without prior notice.

To fully explain or describe how this product should be used, this manual may refer to names of other products or companies without any intention of infringement.

Disclaimer of warranties: Lumens Digital Optics Inc. is neither responsible for any possible technological, editorial errors or omissions, nor responsible for any incidental or related damages arising from providing this file, using, or operating this product.

Chapter 1 Safety Instructions





Always follow these safety instructions when setting up and using this product:

1. Use attachments only as recommended.
2. Use the type of power source indicated on the Keyboard Controller. If you are not sure of the type of power available, consult your distributor or local electricity company for advice.
3. Always take the following precautions when handling the plug. Failure to do so may result in sparks or fire:
 - Ensure the plug is free of dust before inserting it into a socket.
 - Ensure that the plug is inserted into the socket securely.
4. Do not overload wall sockets, extension cords or multi-way plug boards as this may cause fire or electric shock.
5. Do not place this product where the cord can be stepped on as this may result in fraying or damage to the lead or the plug.
6. Never allow liquid of any kind to spill into this product.
7. Except as specifically instructed in this User Manual, do not attempt to operate this product by yourself. Opening or removing covers may expose you to dangerous voltages and other hazards. Refer all servicing to licensed service personnel.
8. Unplug this product during thunderstorms or if it is not going to be used for an extended period. Do not place this product or remote control on top of vibrating equipment or heated objects such as a car, etc.
9. Unplug this product from the wall outlet and refer servicing to licensed service personnel when the following situations happen:
 - If the power cord or plug becomes damaged or frayed.
 - If liquid is spilled into this product or this product has been exposed to rain or water.

■ Precautions

Warning: To reduce the risk of fire or electric shock, do not expose this appliance to rain or moisture.

If the this product will not be used for an extended time, unplug it from the power socket.

	<p>Caution Risk of Electric Shock Please do not open it by yourself.</p>		
<p>Caution: To reduce the risk of electric shock, do not remove cover (or back). No user-serviceable parts inside. Refer servicing to licensed service personnel.</p>			
	<p>This symbol indicates that this equipment may contain dangerous voltage which could cause electric shock.</p>		<p>This symbol indicates that there are important operating and maintenance instructions in this User Manual with this unit.</p>

■ FCC Warning

This equipment has been tested and found to comply with the limits for a Class B digital device, pursuant to part 15 of the FCC Rules. These limits are designed to provide reasonable protection against harmful interference in a residential installation. This equipment generates, uses and can radiate radio frequency energy and, if not installed and used in accordance with the instructions, may cause harmful interference to radio communications. However, there is no guarantee that interference will not occur in a particular installation. If this equipment does cause harmful interference to radio or television reception, which can be determined by turning the equipment off and on, the user is encouraged to try to correct the interference by one or more of the following measures:

- Reorient or relocate the receiving antenna.
- Increase the separation between the equipment and receiver.
- Connect the equipment into an outlet on a circuit different from that to which the receiver is connected.
- Consult the dealer or an experienced radio/TV technician for help.

Notice :

The changes or modifications not expressly approved by the party responsible for compliance could void the user's authority to operate the equipment.

This product has been tested and found to comply with the limits for a Class B computer device, pursuant to Article 15-J of FCC Rules. These limits are designed to provide reasonable protection against harmful interference in a commercial installation.

This digital apparatus does not exceed the Class B limits for radio noise emissions from digital apparatus as set out in the interference-causing equipment standard entitled "Digital Apparatus," ICES-003 of Industry Canada.

Cet appareil numérique respecte les limites de bruits radioélectriques applicables aux appareils numériques de Classe B prescrites dans la norme sur le matériel brouilleur: "Appareils Numériques," NMB-003 édictée par l'Industrie.

Chapter 2 Product Overview

2.1 I/O Introduction

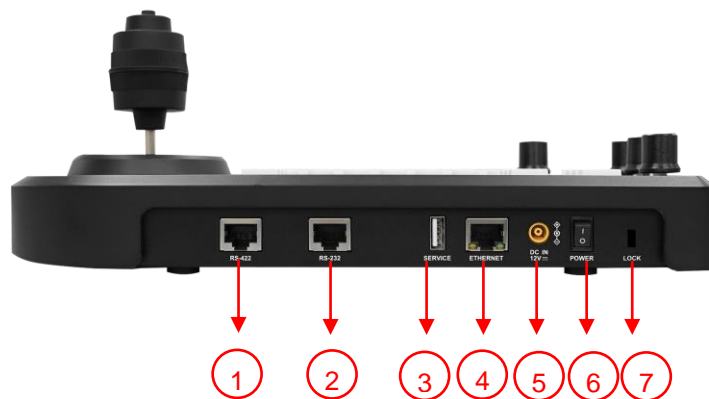

No	Item	Function Descriptions
1	RS-422 port	Connect the RS-422 adapter cable that can control up to 7 cameras
2	RS-232 port	Connect the RS-232 adapter cable that can control up to 7 cameras
3	USB port	Update the keyboard control firmware via a USB disk Note Use format "FAT32", "capacity less than 32G"
4	IP port	Connect the RJ45 network cable ▪ Supports PoE(IEEE802.3af)
5	12 V DC power port	Connect the included DC power supply adapter and the power cable
6	Power Button	Turn on/off keyboard power
7	Safety lock	Use the safety lock to lock the keyboard for anti-theft purpose

Note RS-232/ RS-422 port do not support POE. Please do not connect with POE Switch

2.2 Panel function introduction

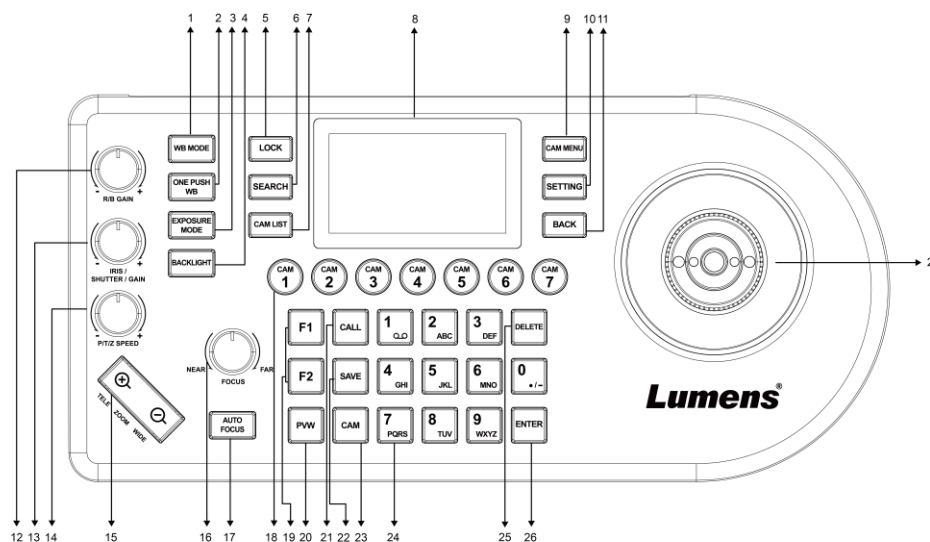

No	Item	Function Descriptions
1	WB	Automatic/manual white balance switch When the setting is automatic white balance, the AUTO indicator will turn on
2	ONE PUSH WB	One push white balance
3	EXPOSURE	Auto, Iris PRI, Shutter PRI
4	BACKLIGHT	Turn on/off back light compensation
5	LOCK	Lock the control of all image adjustment and rotary buttons Press and hold for 3 seconds to enable the lock; press and hold for 3 seconds again to cancel the lock
6	SEARCH	Search or add the camera IP setting
7	CAM LIST	Check the currently connected camera
8	LCD screen	Display control and setting information of the keyboard
9	CAM MENU	Call the camera OSD menu
10	SETTING	Enter the settings menu
11	BACK	Back to the previous step
12	R/B GAIN	Adjust the white balance in red/blue manually
13	IRIS / SHUTTER	Adjust the aperture or shutter
14	P/T/Z SPEED	Rotate: Adjust/control the speed Press: Switch between P/T or Z
15	ZOOM SEESAW	Control ZOOM in/out
16	FOCUS CONTROL	Rotate the knob to adjust NEAR/FAR parameters (for Manual Focus use only) Press to execute One Push Focus LCD menu: Rotate left/right to adjust parameters and navigate the menu LCD menu: Press to select an item
17	AUTO FOCUS	Automatic/manual focus switch When the setting is automatic focus, the AUTO indicator will turn on
18	CAMERA BUTTON CAM1~CAM7	Quickly select Camera 1 ~ 7 and control the camera within 1 second Press and hold for 3 seconds to access the shortcut key settings page
19	Assign Button F1~F2	Set up the shortcut key to quickly control the camera
20	PVW	Press to display the camera's RTSP streaming video
21	CALL	Press number button to call a camera preset position
22	SAVE	Press number button to save a camera preset position
23	CAM	Press number button to select the specific camera (Cam 1 - 255)

No	Item	Function Descriptions
24	Letter and number keyboard 0 ~ 7	CALL a camera; call a preset position; key in the camera name (LCD menu)
25	DELETE	Control LCD menu to execute "delete" action
26	ENTER	Control LCD menu to execute "confirm" action
27	PTZ joystick	Control the camera PTZ operation

2.3 LCD screen display description

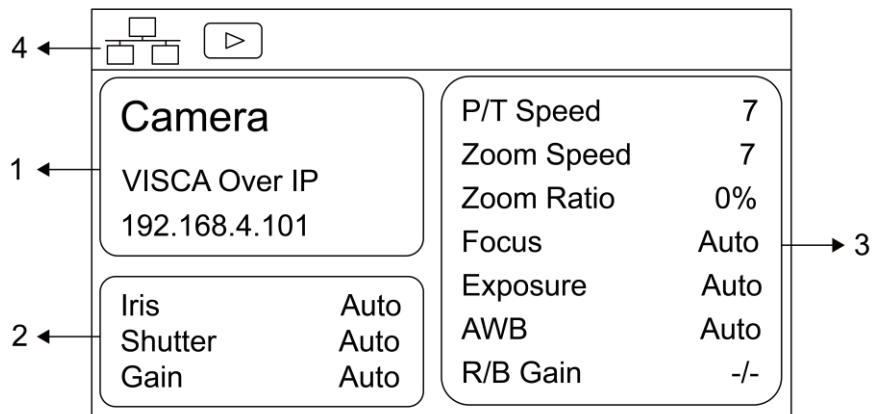

No	Item	Function Descriptions
1	Camera ID and protocol	Display the camera currently under control and the protocol currently in use
2	EXPOSURE MODE	Display the current camera exposure mode
3	Connected device parameter information	Display the current camera parameter information
4	Network connection indication status	If the play icon appears, the camera's RTSP streaming video can be displayed

Chapter 3 LCD function menu description

3.1 Access LCD function menu

Press the SETTING button on the keyboard to access the LCD function menu



3.2 Hot Key Camera

Item	Settings	Description
CAM	1~7	Assign the camera number; 7 units can be set at most

■ Advanced settings for Hot Key Camera

Item	Settings	Description
Alias	-	The camera can be named using letters on the keyboard
Protocol	VISCA VISCAIP VISCATCP ONVIF NDI	Select a control protocol to be used for connecting the camera Only VS-KB21N support NDI.
Address	1~7	Set VISCA ID from 1 to 7
Baudrate	9600 / 19200 / 38400 / 115200	Set control Baudrate
Stream URL	rtsp://cam ip:8557/h264	Can be automatically imported based on added models
RTSP Authentication	Off/On	Select to enable RTSP Authentication function
User Name	admin	Automatically import account and password, shown by User name.
Password	9999	Automatically import account and password, shown by *****
Select from List	-	Select a specific camera from the CAM List and apply it automatically

3.3 Device Management

Item	Settings	Description
Device List	-	View the current device list
Add a New List	-	Add a new device
Ignored Device List	-	View the current list of ignored devices
Add an Ignored Device	-	Add an ignored device

3.4 Network

Item	Settings	Description
Type	STATIC / DHCP	Specify a static IP or let DHCP to assign an IP to the keyboard
IP Address	192.168.0.100	For a static IP, specify the IP address in this field (Default IP is 192.168.0.100)
Subnet Mask	255.255.255.0	For a static IP, specify the subnet mask in this field
Gateway	192.168.0.1	For a static IP, specify the gateway in this field

DNS 1	192.168.0.1	Set DNS 1 information
DNS 2	8.8.8.8	Set DNS 2 information

3.5 KEYS

Item	Settings	Description
F1 ~ F2	None	<p>F1 ~ F2 buttons can be set as shortcut keys separately</p> <p>Functions may be set as the list displayed to the left</p> <p>After selecting Function, choose the target function</p> <p>Press the shortcut key and the camera will perform the specified function quickly</p>
	Home	
	Power	
	Mute	
	Picture Freeze	
	Picture Flip	
	Picture	
	LR_Reverse	
	Tracking Mode	
	Framing Mode	
	Auto Tracking On	
	Auto Tracking Off	
	Auto Framing On	
	Auto Framing Off	
	D-Zoom On	
	D-Zoom Off	
	Group	
Custom		
Commands		

3.6 Display

Item	Settings	Description
Theme Color	Red Green <u>Blue</u> Orange Purple	Adjust LCD theme color
Brightness	Low Medium <u>High</u>	Adjust keyboard brightness
Key Brightness	Low <u>Medium</u> High	Adjust key brightness

3.7 Beep

Item	Settings	Description
Enable	<u>Off</u> / On	Turn on or off button sound effects
Style	<u>1</u> / 2 / 3	Select the button sound type

3.8 Joystick

Item	Settings	Description
Zoom Enable	On / Off	Enable/Disable the Joystick control for Zoom
Pan Reverse	On / Off	Enable/Disable the horizontal inversion
Tilt Reverse	On / Off	Enable/Disable the vertical inversion
Correction	-	Correct the Joystick direction

3.9 Tally

Item	Settings	Description
Enable	ON / OFF	Enable the Tally light

3.10 Language

Item	Description
English / Simplified Chinese / Traditional Chinese	Language setting

3.11 Password Setting

Item	Settings	Description
Enable	ON / OFF	Once enabled, you need to enter a password when entering SETTINGS
Change Password	-	Set up a new password

3.12 Sleep Mode

Item	Settings	Description
Enable	ON / OFF	Enable the sleep mode
Goes to Sleep after	15 Mins / 30 Mins / 60 Mins	Set the sleep mode activation time
Lightness change	LCD Screen Light Keypad Backlight	Set the sleep mode preview screen and keyboard brightness

3.13 About Device

Item	Description
-	Display device information

3.14 Reset Device



Item	Settings	Description
Reset Setting	ON / OFF	Remain the keyboard network and CAM LIST, restore other settings to default values
Reset Setting and Data	ON / OFF	Clear all keyboard settings, including IP setting

Chapter 4 Camera connection

VS-KB21/ VS-KB21N supports RS-232, RS-422 and IP control.

Supported control protocols include: VISCA, VISCA over IP

4.1 Port pin definition

RS-232			IP			RS-422		
1 8			1 8			1 8		
								
Pin No.	Function	Color	Pin No.	Function	Color	Pin No.	Function	Color
1	-	Orange/White	1	TX+	Orange/White	1	TX-	Orange/White
2	-	Orange	2	TX-	Orange	2	TX+	Orange
3	GND	Green/White	3	RX+	Green/White	3	GND	Green/White
4	-	Blue	4	n/c	Blue	4	-	Blue
5	-	Blue/White	5	n/c	Blue/White	5	-	Blue/White
6	GND	Green	6	RX-	Green	6	-	Green
7	TXD	Brown/White	7	n/c	Brown/White	7	RX-	Brown/White
8	RXD	Brown	8	n/c	Brown	8	RX+	Brown

4.2 How to Connect RS-232

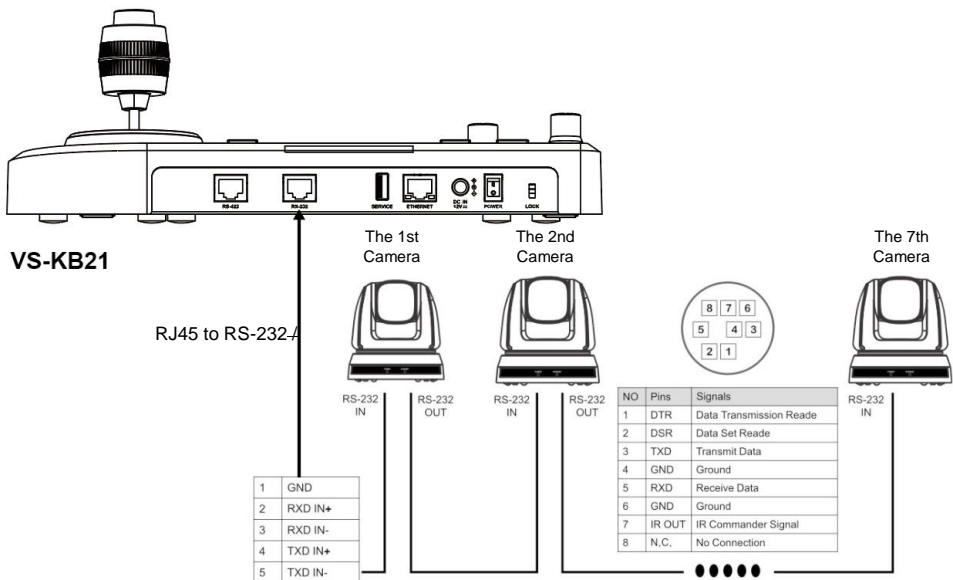

1. Please refer to the RJ-45 to RS-232 and camera Mini Din RS-232 pin definitions to complete the cable connection

Note This is compatible with Lumens optional accessory VC-AC07, which can be connected via network cable.

2. Camera settings

- Protocol set to VISCA
- Control Port set to RS-232

3. Keyboard settings

- Press [SETTING] and select [Hot Key Camera]
- Select CAM1~7
- Configure the camera information.
- Protocol set to VISCA
- Press [Back] exit

4.3 How to Connect RS-422

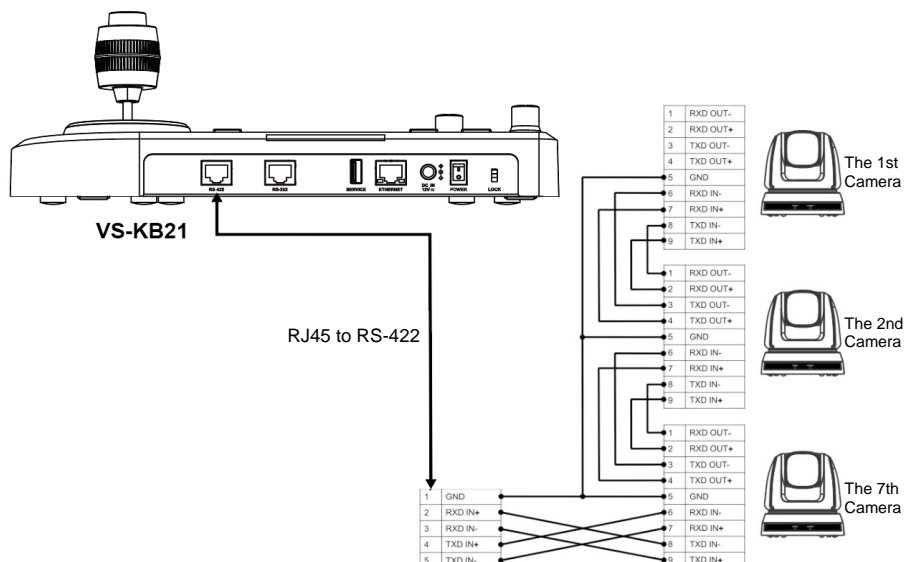

1. Please refer to the RJ-45 to RS-422 and camera RS-422 pin definitions to complete the cable connection
2. Camera settings
 - Protocol set to VISCA
 - Control Port set to RS-422
3. Keyboard settings
 - Press [SETTING] and select [Hot Key Camera]
 - Select CAM1~7
 - Configure the camera information.
 - Protocol set to VISCA
 - Press [Back] exit

4.4 How to Connect IP

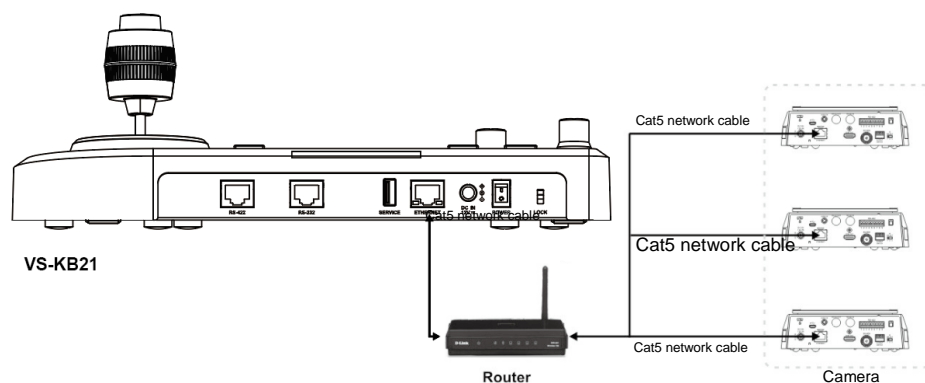

1. Use network cables to connect keyboard and IP camera to the router
2. Set keyboard IP address
 - Press [SETTING], select [Network]
 - Type: Select STATIC or DHCP
 - IP Address: If select STATIC, use Focus Near/Far to choose the location, input the IP address via numbers on the keyboard. Last, press ENTER to save and exit
3. Add a camera
 1. Automatic Search

Note Only VS-KB21N support NDI

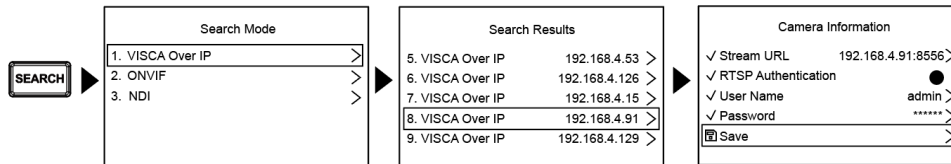

- Press [SEARCH] and select search mode
- Select the target camera and set the camera information
- Click [Save] at the bottom and you can check the saved camera at [CAM List]

2. Manual Add

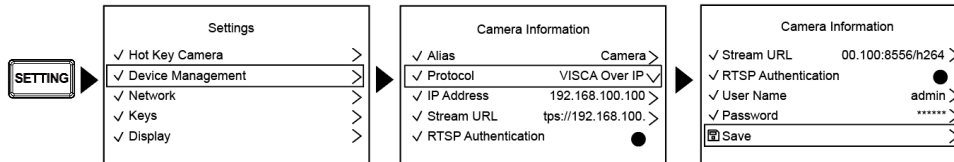

- Press [SETTING]> [Device Management]
- Add new camera to configure the camera information.
- Select Protocol VISCAIP/ONVIF, and set the camera IP address
- Press SAVE at the bottom to save

Chapter 5 Web Interface

5.1 Connecting Camera to Network

Please find the two common connection methods below

1. Connecting via switch or router



2. To connect directly through network cable, the IP address of the keyboard and PC should be changed to set at the same network segment

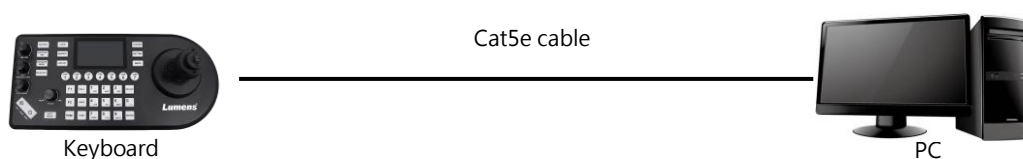

5.2 Web Login

1. Open the browser, and enter the IP address of the keyboard in the address bar
2. Enter administrator's account and password

Note For the first-time login, please refer to [5.3.8 System- User Management](#) to change the default password

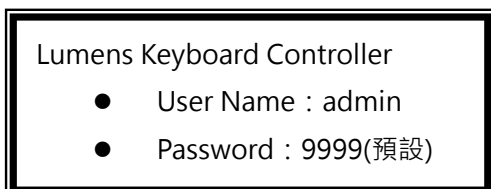

5.3 Web Page Functions

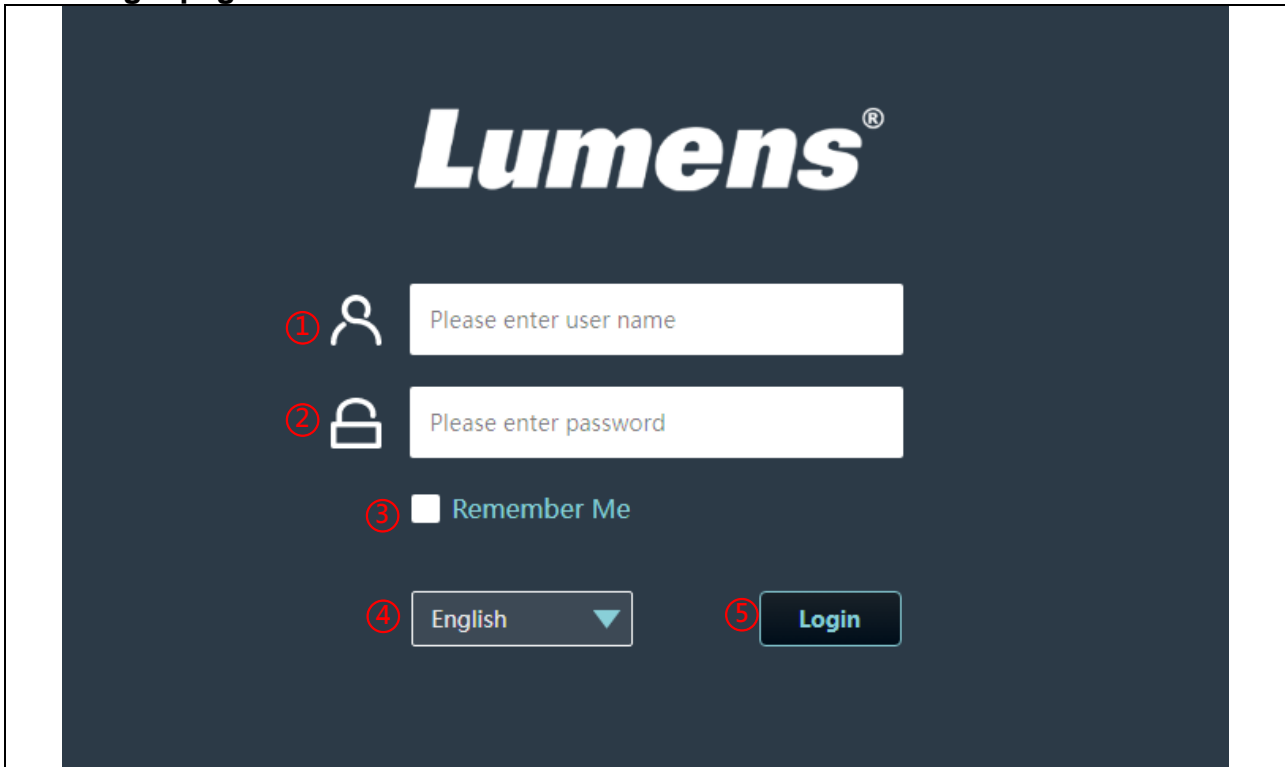

5.3.1 Login page



No	Item	Description
1	User Name	Enter user login account (default: admin)
2	User Password	Enter user password (default: 9999) <small>Note</small> For the first-time login, please refer to 5.3.8 System- User Management to change the default password
3	Remember Me	Save user name and password.
4	Language	Supporting English/Traditional Chinese/Simplified Chinese
5	Login	Log in to the administrator screen on the website

5.3.2 Hot Key

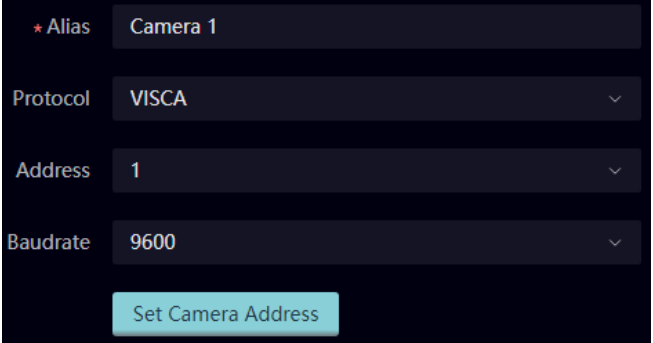
No	Item	Description
1	Hot Key	Configure hot keys for cameras
2	Device Management	Manage connected devices
3	Custom Command	Configure custom commands
4	Network	Configure network settings
5	Firmware Update	Update device firmware
6	System	Configure system settings
7	About	View system information

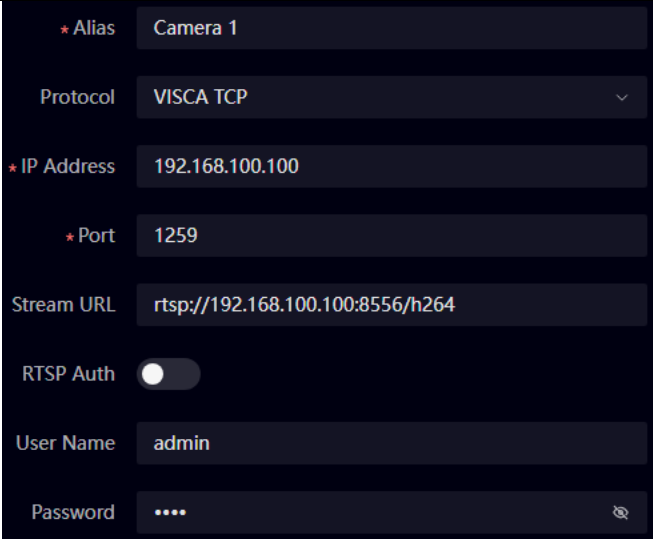
1	CAM1~7	Support hot key camera 1~7
2	Setting page	Click to open the settings page. Following settings can be configured depending on the protocols.
2.1	VISCA	 <ul style="list-style-type: none"> ▪ Alias: Edit camera name ▪ Address: Set the address. ▪ Baudrate: Set the Baudrate ▪ Set Camera Address: When cameras are connected daisy chain, you can set camera address. This action will send “address set” command to the camera.
2.2	VISCA Over IP	 <ul style="list-style-type: none"> ▪ Alias: Edit camera name ▪ IP Address: Enter IP address ▪ Stream URL: Display the stream URL ▪ RTSP Auth: Enable/ Disable RTSP authentication ▪ User Name: Name for RTSP Auth ▪ Password: Password for RTSP Auth
2.3	VISCA TCP	 <ul style="list-style-type: none"> ▪ Alias: Edit camera name ▪ IP Address: Enter IP address ▪ Port: Setting range 1~65534

		<ul style="list-style-type: none"> ▪ Stream URL: Display the stream URL ▪ RTSP Auth: Enable/ Disable RTSP authentication ▪ User Name: Name for RTSP Auth ▪ Password: Password for RTSP Auth
2.4	ONVIF	<div data-bbox="564 226 1214 824" style="background-color: #2c3e50; color: white; padding: 10px; border: 1px solid #2c3e50;"> <p>* Alias <input type="text" value="Camera 1"/></p> <p>Protocol <input type="text" value="ONVIF"/></p> <p>* IP Address <input type="text" value="192.168.100.100"/></p> <p>Account <input type="checkbox"/></p> <p>User Name <input type="text" value="Please enter Onvif User name"/></p> <p>Password <input type="password" value="Please enter Onvif Password"/></p> <p>RTSP Auth <input type="checkbox"/></p> <p>User Name <input type="text" value="admin"/></p> <p>Password <input type="password" value="...."/></p> </div> <ul style="list-style-type: none"> ▪ Alias: Edit camera name ▪ IP Address: Enter IP address ▪ Account: Enable/ Disable ONVIF account. Support to preview(PVW) camera image when it enabled. ▪ User Name: Name for ONVIF account ▪ Password: Password for ONVIF account ▪ RTSP Auth: Enable/ Disable RTSP authentication ▪ User Name: Name for RTSP Auth ▪ Password: Password for RTSP Auth

5.3.3 Device Management

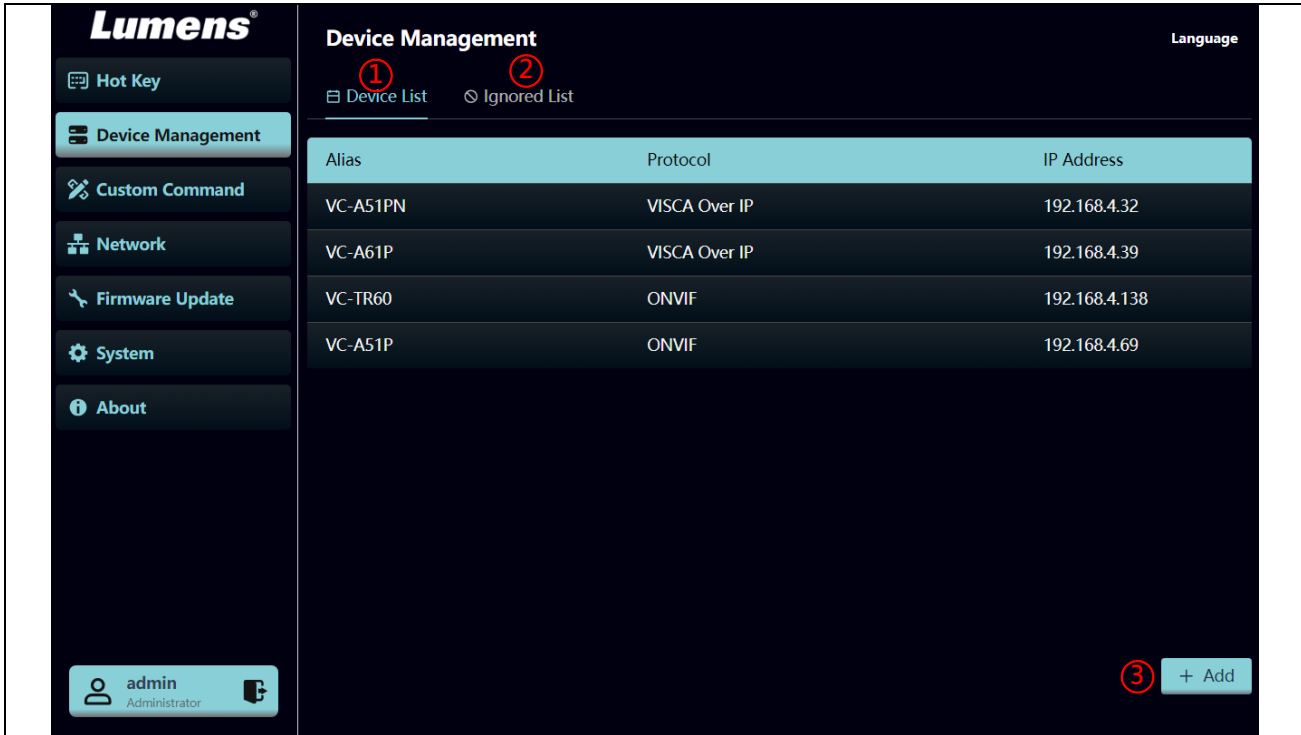

No	Item	Description
1	Device List	Display the device list, and click on a device to edit.
2	Ignored List	Display the ignored list, and click on a device to edit.
3	+ Add	<ul style="list-style-type: none"> Device List: According to the protocols, enter related information to add a camera. Ignored List : Enter the IP address and protocol to add camera. <p>Note If the camera is with NDI protocol, the [Add] function is not supported.</p>

5.3.4 Custom Command

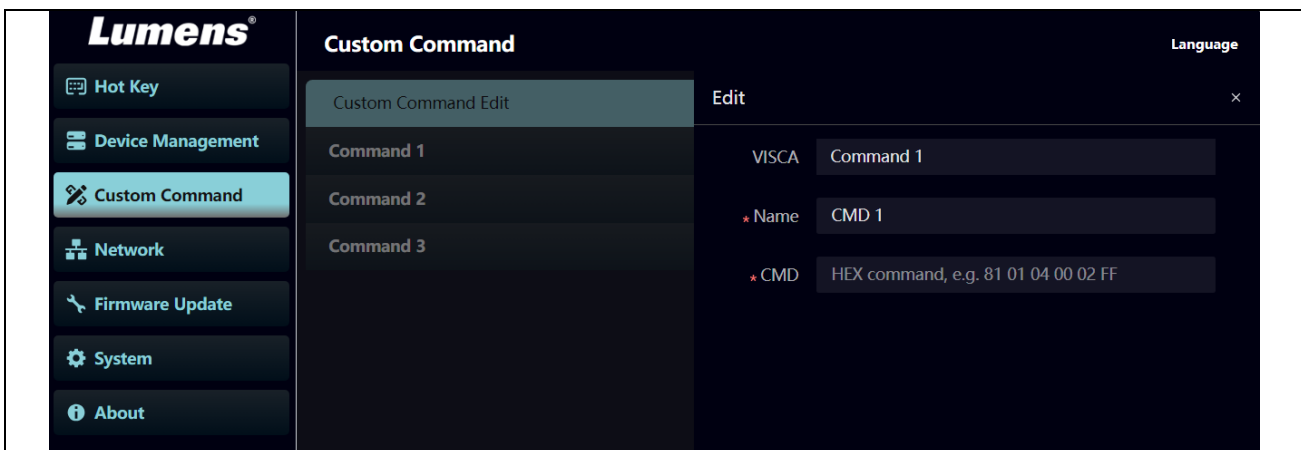

Description
<p>Supports 3 customized command.</p> <p>Click on the command to open the editing page for customizing commands.</p>

5.3.5 Network

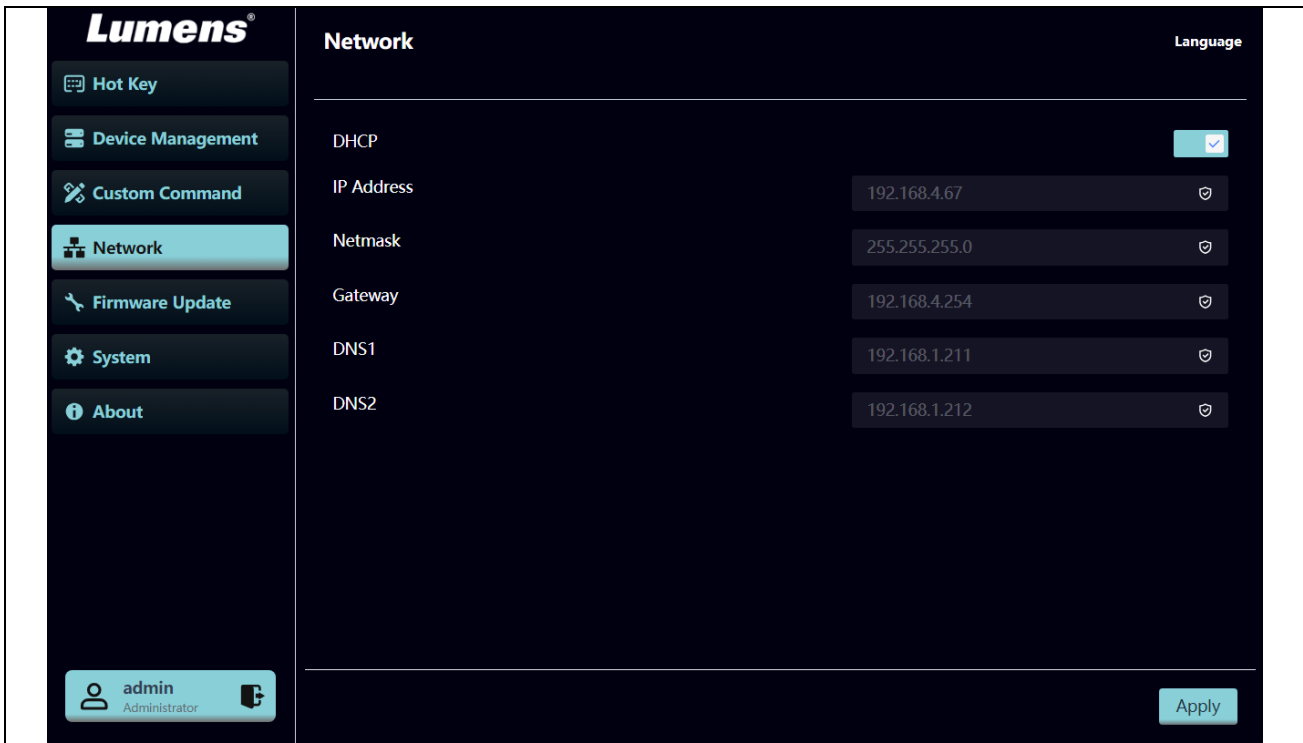

Description

Keyboard controller network settings. When the DHCP function is disabled, Network settings can be edited.

5.3.6 Firmware Update

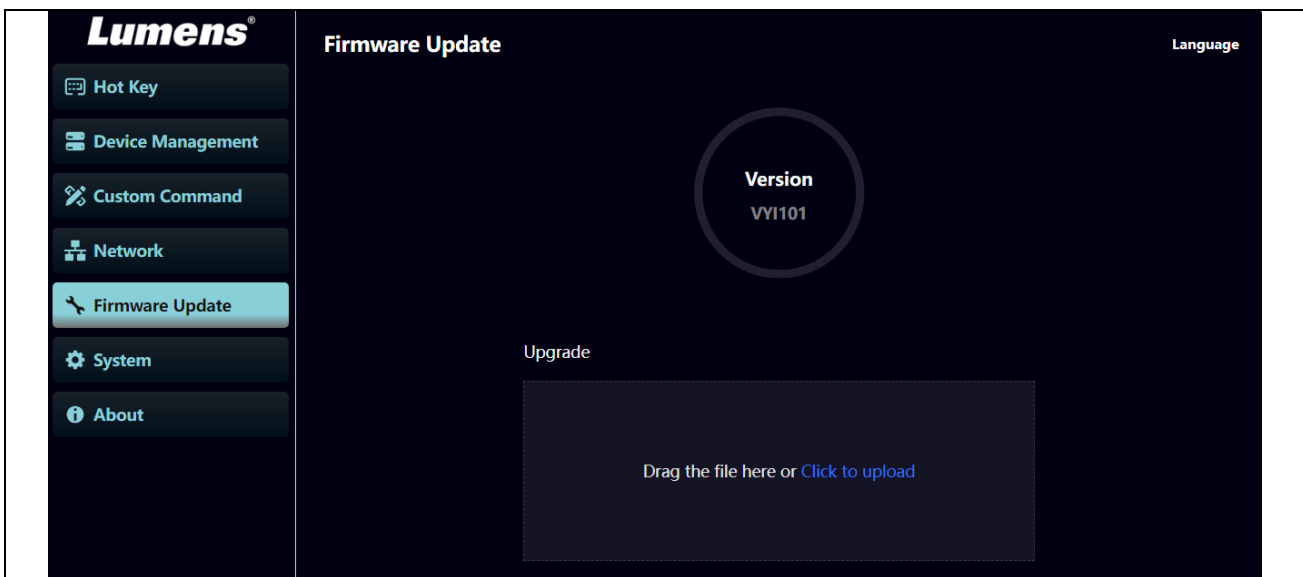

Description

Display the current firmware version. User can upload a file to update the firmware.

Note Update process takes approximately 3 minutes

Note Do not operate or power off the device during the update to prevent firmware update failure.

5.3.7 System- Configuration File

Description

Save the configuration as a file. User can import/ export the configuration file.

5.3.8 System-User Management

Description

Add/ Edit/ Delete user account

- The default administrator cannot be deleted.
- Support up to 8 user accounts (administrator + common users).
- Supporting 4 - 32 characters for user name and password
- Characters should be English letters or numbers. Chinese and special symbols are not allowed.
- User permissions:

Type	Admin	Common
Language	V	V
Web settings	V	X
User Management	V	X

5.3.9 About

Lumens[®] About Language

- Hot Key
- Device Management
- Custom Command
- Network
- Firmware Update
- System
- About

admin
Administrator

Lumens

Get Help ?

www.Mylumens.com
Copyright © Lumens Digital Optics Inc. All rights reserved.

About

Model Name	VS-KB21
Firmware Version	VI101
MAC Address	DC:E2:AC:03:80:29
Serial Number	VDNA00028
Start Up time	28 h 48 min

Description

Display device firmware version, serial number, and related information. For technical support, please scan the QRcode at the bottom right for assistance

Chapter 6 Common Functions

6.1 Call the camera

6.1.1 Use the number keyboard to call the camera

1. Key in the camera number to be called via the keyboard
2. Press the “CAM” button

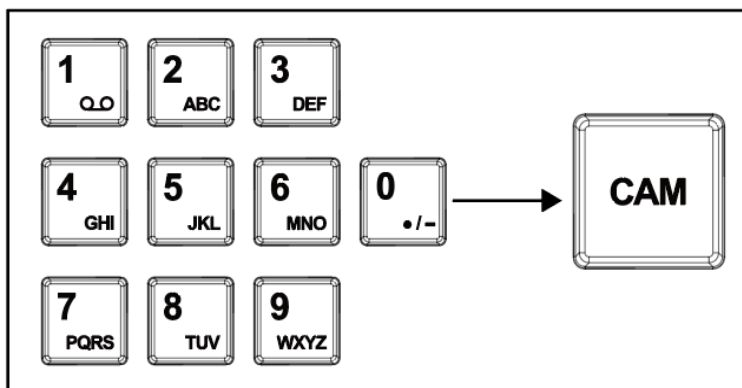

6.2 Setup/call/cancel preset position.

6.2.1 Save the preset position

1. Relocate the camera to the desired position
2. Enter the desired preset position number, then press the SAVE button to save

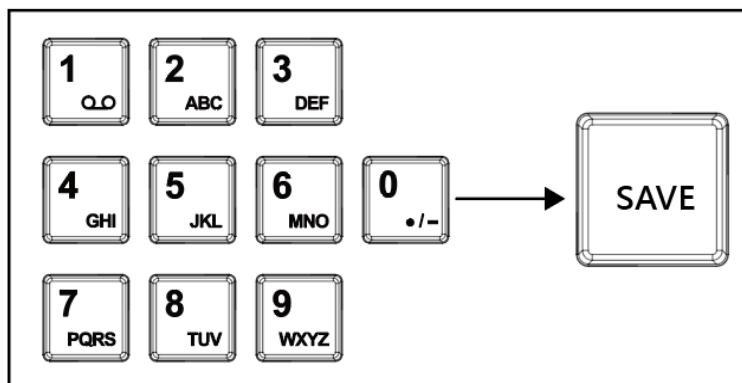

6.2.2 Call the preset position

1. Key in the desired preset position number via keyboard
2. Press “CALL” button

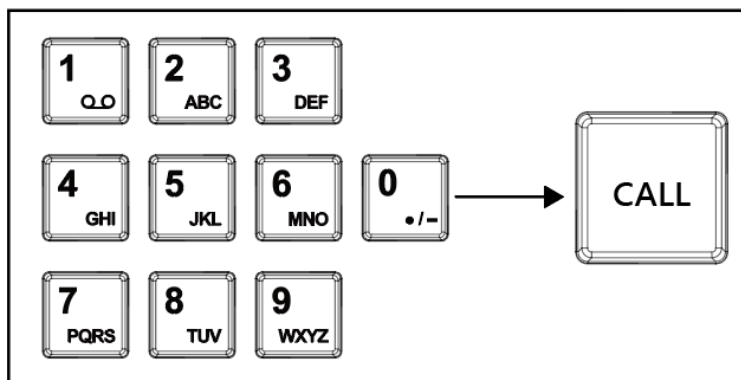

6.3 Set the camera OSD menu via the keyboard

1. Press the “CAM MENU” button on the keyboard
2. Set the camera OSD menu via the PTZ joystick
 - Move the joystick up and down. Switch the menu items/Tune the parameter values
 - Move the joystick to the right: Enter
 - Move the joystick to the left: Exit

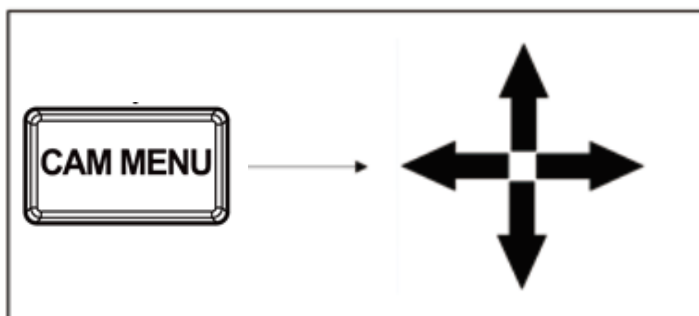

Chapter 7 Troubleshooting

This Chapter describes questions frequently asked during the use of VS-KB21/ VS-KB21N and suggests methods and solutions.

No.	Problems	Solutions
1	After plugging in the power supply, VS-KB21/ VS-KB21N power is not on	<ol style="list-style-type: none">1. Please check whether the power button on the back is pressed down correctly2. If POE is used, please make sure the Ethernet network cable is correctly connected to the power port of the POE switch
2	VS-KB21/ VS-KB21N can't control the camera through RS-232/ RS-422	<ol style="list-style-type: none">1. Please confirm the port pin connection is correct (RS-232/422)2. Please confirm if the camera OSD is correctly switched to RS-232/RS-422 and the baud rate setting is the same as the controller.3. Please confirm whether the MENU button on the keyboard is pressed down by mistake, causing the camera OSD menu to open and the camera unable to be controlled
3	Cannot use the keyboard buttons to change the image settings or focus	Please confirm the LOCK button is set in "LOCK" mode

※For questions about the installation, please scan the following QR Code. A support person will be assigned to assist you



SERVICE