

## ENVIROMUX® Series

# Temperature/Humidity Sensor Installation Manual



**E-STSM-E7, STHSM-E7**  
Temperature/Humidity Sensors



**E-STHS-LCDW**  
Temperature/Humidity Sensor w/LCD Display



**E-STHSB-N4085IND-x**  
Industrial Temperature/  
Humidity Sensor



**E-STHSB**  
Temperature/Humidity Sensor



**E-STHS-LSH**  
Low Self-Heating  
Temperature/Humidity Sensor

**TABLE OF CONTENTS**

Introduction..... 1

Mounting..... 1

    E-STHS-LCDW..... 2

        Mounting Instruction ..... 3

Connect Sensors..... 4

    RJ45 Sensors ..... 4

        E-STHS-LCDW ..... 5

        RJ45 Sensor Cable..... 12

**TABLE OF FIGURES**

Figure 1- Keyhole slot for standard mounting ..... 1

Figure 2- DIN rail clip ..... 1

Figure 3- Connect Sensors using CAT5 cable with RJ45 connectors..... 4

Figure 4- A portion of the sensor configuration page ..... 4

Figure 5- E-STHS-LCDW..... 5

## INTRODUCTION

Many different sensors can be connected to the ENVIROMUX Series Enterprise Environment Monitoring Systems. Series models covered by this manual include ENVIROMUX-SEMS-16U and E-16D/5D/2D. A complete listing of available sensors and accessories can be found at

<http://www.networktechinc.com/enviro-rems.html> for the ENVIROMUX-SEMS-16U,

<http://www.networktechinc.com/environment-monitor-16d.html> for the E-16D,

<http://www.networktechinc.com/environment-monitor-5d.html> for the E-5D,

<http://www.networktechinc.com/environment-monitor-2d.html> for the E-2D, and Manuals for each Environment Monitoring System covering installation and configuration for all features can also be found at these websites.

This manual is only provided to instruct how to install the ENVIROMUX temperature and humidity sensors to these systems.

## MOUNTING

Most of the ENVIROMUX Temperature and Humidity sensors are intended for indoor use only. These sensors can be mounted in any position but include a keyhole slot on the back to enable quick wall-mounting if desired.

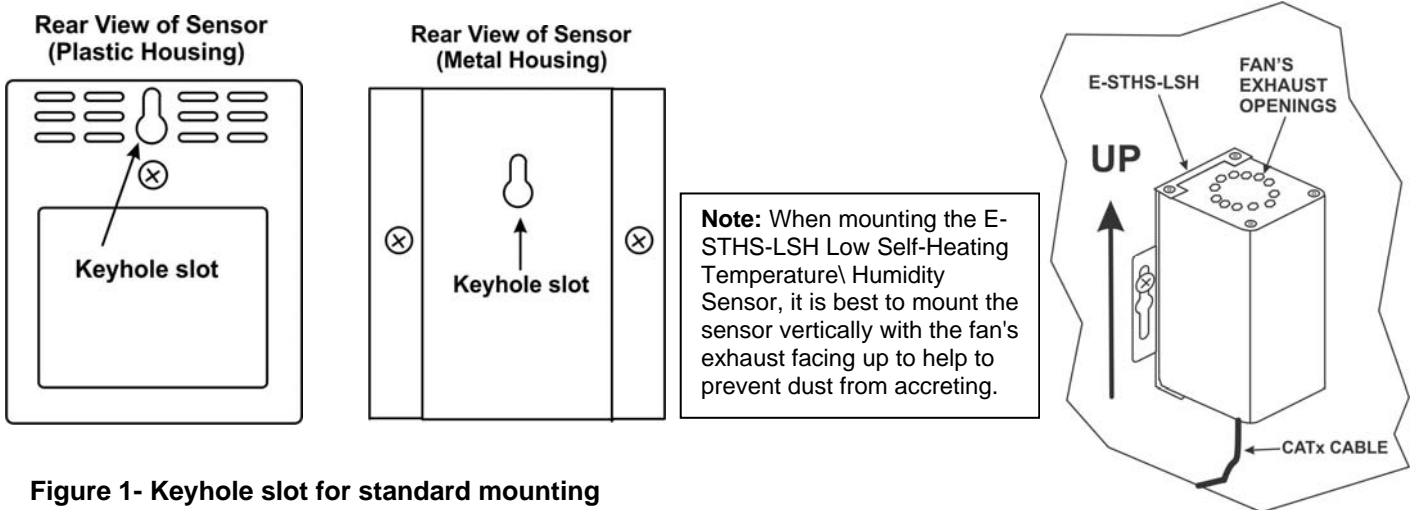

Figure 1- Keyhole slot for standard mounting

If you have purchased an ENVIROMUX Sensor with a DIN rail clip for DIN rail mounting, see the drawing (page 2) for instructions to install the sensor to the DIN rail.

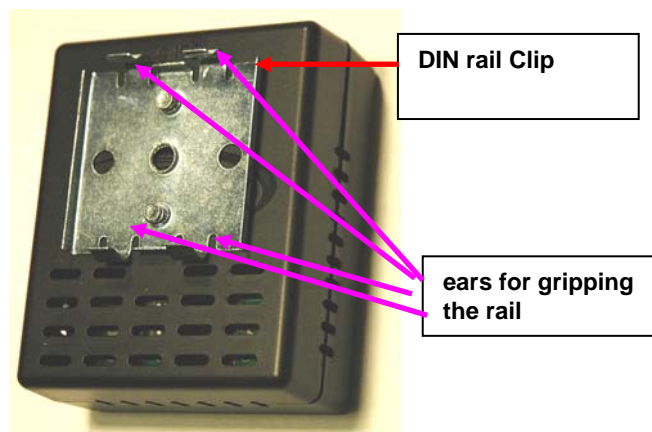
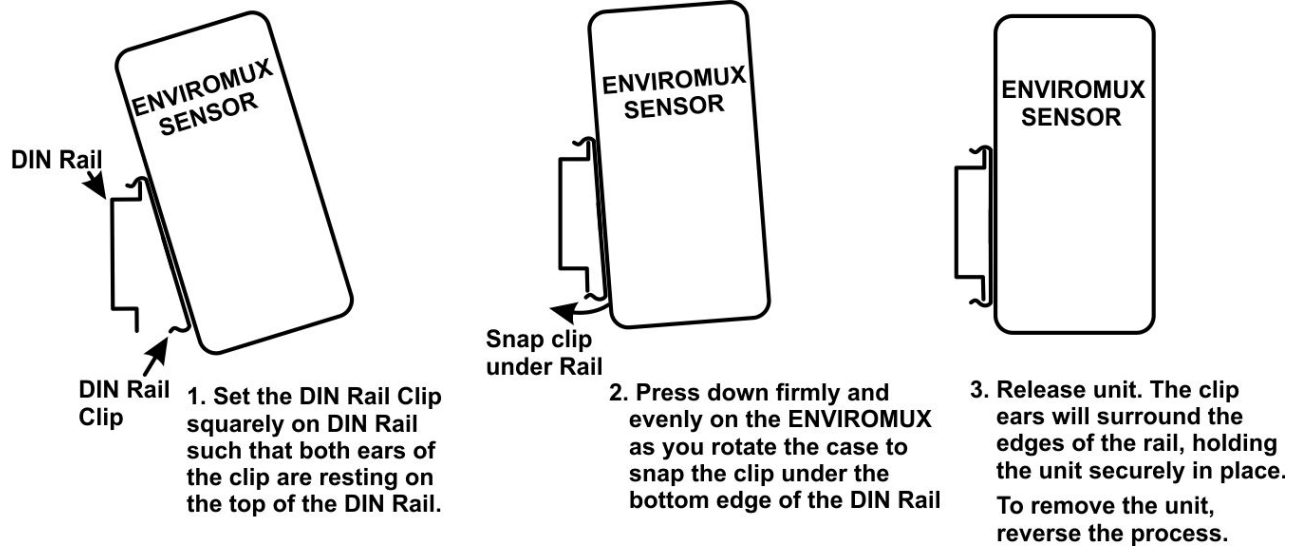

Figure 2- DIN rail clip

## NTI ENVIROMUX TEMPERATURE/HUMIDITY SENSOR ATTACHMENT



## E-STHS-LCDW

The E-STHS-LCDW is a Temperature and Humidity sensor built into a large wall-mount LCD display with 2" character height for easy viewing from a distance. There are two key-hole slots on the back, 4-1/2" apart, for hanging the sensor on the wall. A template has been provided to make placement and hardware location easy. There are also two brackets (with screws) that can be mounted to the sides. These are provided for an alternate method of mounting.

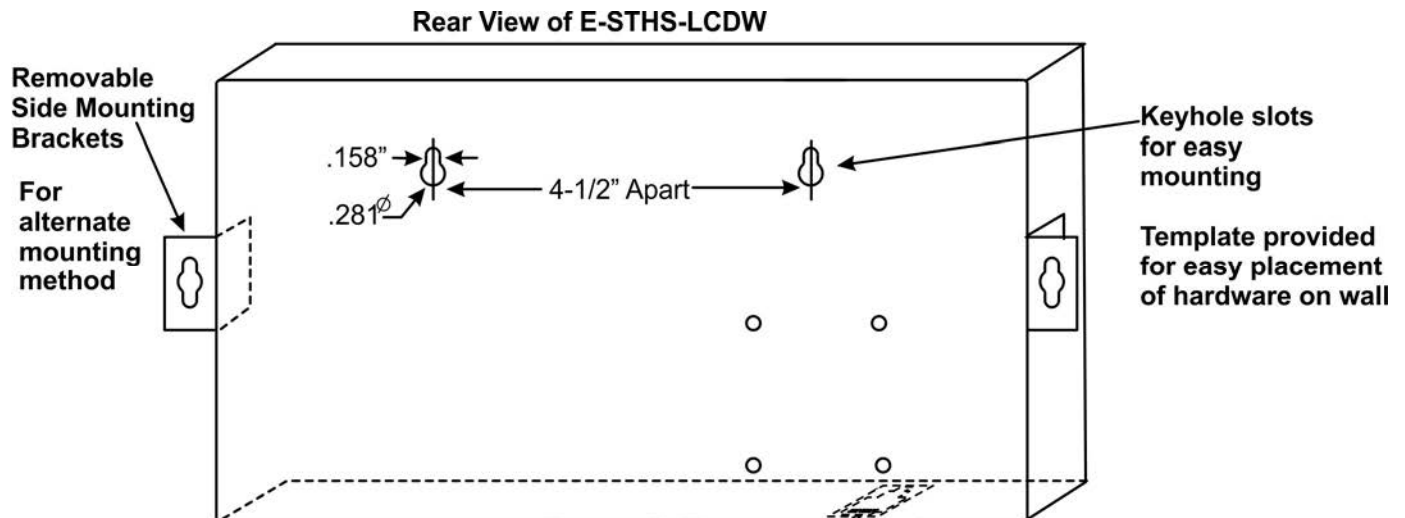
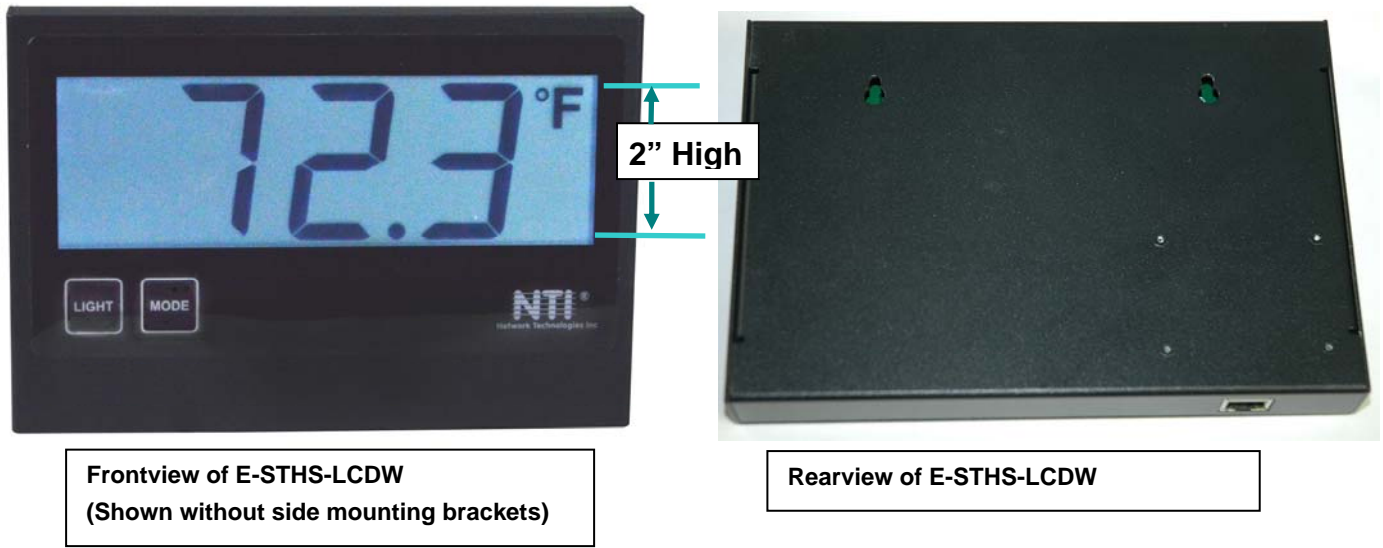

## NTI ENVIROMUX TEMPERATURE/HUMIDITY SENSOR ATTACHMENT



Template for easy mounting the E-STHS-LCDW

### Mounting Instruction

#### **Using Side Brackets**

1. Mount one side bracket to each side of the sensor with the screws provided.
2. Position sensor and mark top of keyholes.
3. Drill two 3/16" diameter holes where top of keyholes were marked.
4. Insert wall anchors (provided) and start the mounting screws.
5. Hang the sensor on the screws and snug down the screws.

#### **Using Rear Keyhole Slots**

1. Position template at mounting location and mark top of keyholes.
2. Drill two 3/16" diameter holes where top of keyholes were marked.
3. Insert wall anchors (provided) and start the mounting screws.
4. Screw in until head of screw is approximately 1/8-3/16" from the wall.
5. Hang the sensor on the screws.

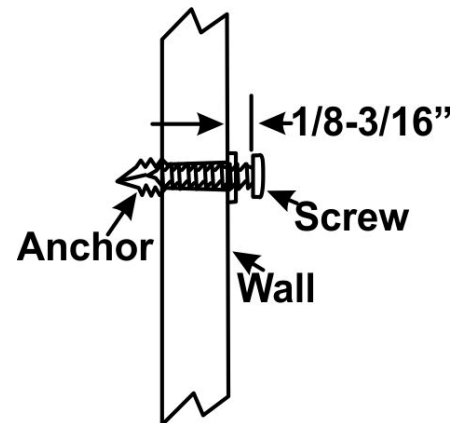

**CONNECT SENSORS**

**RJ45 Sensors**

The temperature and humidity sensors for the E-16D/5D/2D and E-SEMS-16(U) Enterprise Environment Monitoring Systems have RJ45 connection ports. Connect each sensor to one of the female connectors labeled "RJ45 Sensors" on the ENVIROMUX using CAT5 cable. The male RJ45 connectors should snap into place. (See page 12 for wiring specification and pinout.) The CAT5 cable that connects the sensor to the ENVIROMUX can be up to 1000 feet in length (except for E-STHS-LCDW, which is limited to 150 feet).

**Note: It is very important to locate the temperature and/or humidity sensors away from ventilation sources and fans.**

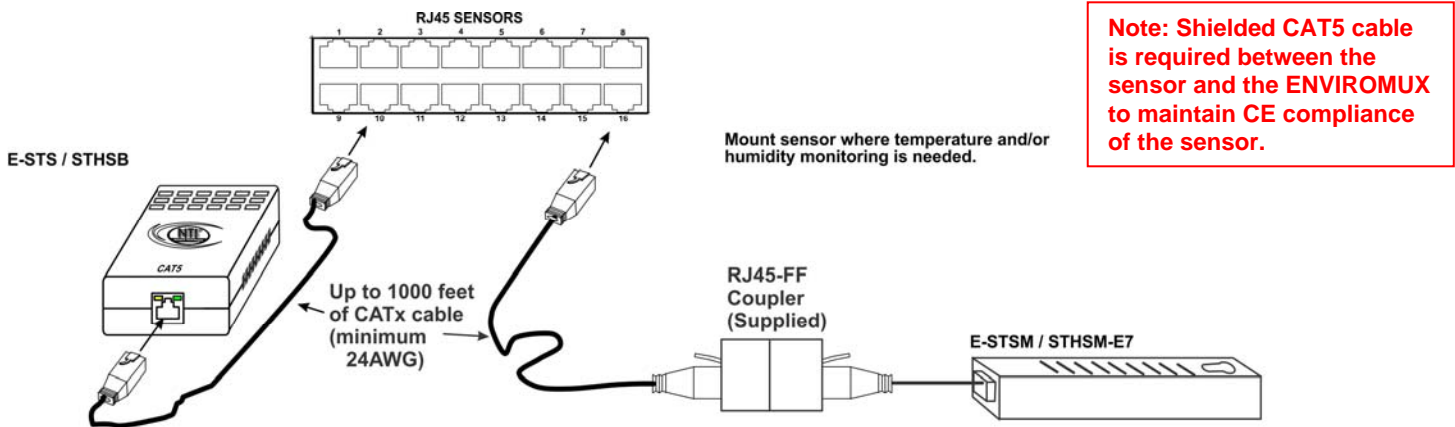

Figure 3- Connect Sensors using CAT5 cable with RJ45 connectors

**Application Note:**

When connecting temperature and humidity sensors to the ENVIROMUX, the web interface will identify the sensor accordingly for the type of sensor it is. The status bar and configuration page will enter the maximum and minimum range that this type of sensor can display if used with the ENVIROMUX, not necessarily the operating range of the sensor itself. The various temperature and humidity sensor models offered by NTI have varying ranges of performance capabilities, as indicated in the table on page 9. Be sure to match the sensor installed to the operating range of the environment it will be expected to work in. Using a sensor outside of its intended temperature range may result in damage to the sensor.

**Sensor #2.1 Configuration (Type: Temperature Combo)**

Sensor Settings	
Description	Sensor #2.1 Descriptive name for the sensor
Group	1 Select which group the sensor belongs to
Units	Deg. F Select the units for the sensor
Min. Level	-4.0 Min. supported value for the sensor
Max. Level	185.0 Max. supported value for the sensor

This is the range the ENVIROMUX will display, not necessarily the range the sensor will work within. See specifications for the sensor being installed for the proper operating environment.

Figure 4- A portion of the sensor configuration page

## NTI ENVIROMUX TEMPERATURE/HUMIDITY SENSOR ATTACHMENT

E-xD firmware version 2.31 or later is required to support this sensor.

### E-STHS-LCDW

The E-STHS-LCDW is a temperature/humidity sensor with built-in LCD display that has 2" tall characters for easy viewing from greater distances. It has a temperature range of -4 to 140°F (-20 to 60°C)  $\pm 0.7^{\circ}\text{F}$  ( $\pm 0.4^{\circ}\text{C}$ ) and will sense 0 to 90% relative humidity  $\pm 4\%$  RH (30°C). It includes two touch-sensitive buttons. One to control the LCD display illumination, and the other to cycle the display mode between temperature in degrees Fahrenheit, temperature in degrees Celsius, and percentage of humidity. The E-STHS-LCDW includes slots on the back for hidden mounting hardware and two brackets for alternative mounting from the sides.

To use the **MODE** button, touch and release to cycle the display from Degrees F. to Degrees C, and to percentage of Humidity, and once again to return to Degrees F. The display will hold the mode set, each time, until MODE is touched again.

To use the **LIGHT** button, touch to illuminate the display for 5 seconds. To keep the display illuminated, touch and hold the LIGHT button for at least 6 seconds. Touch and release again to have illumination stop after 5 more seconds.

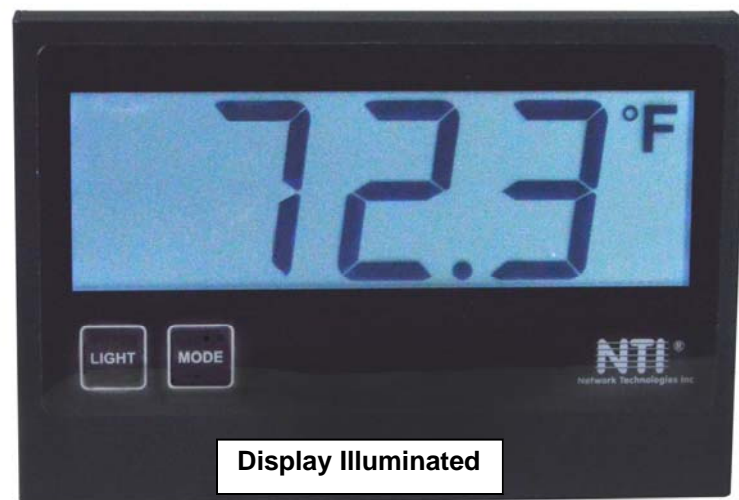
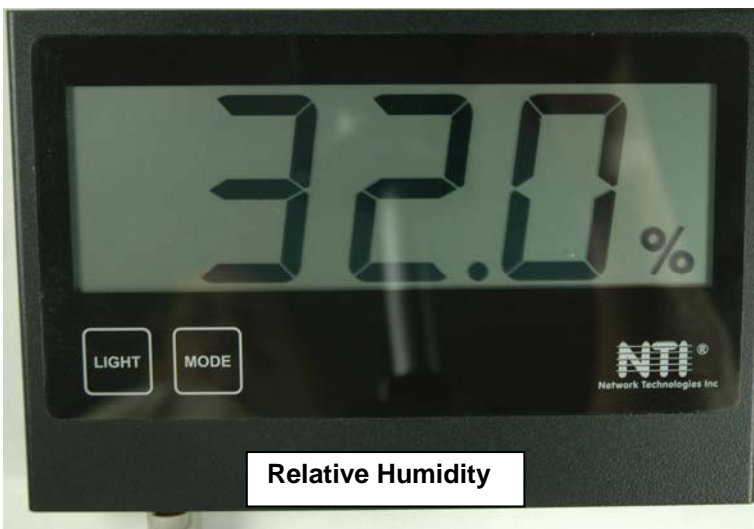
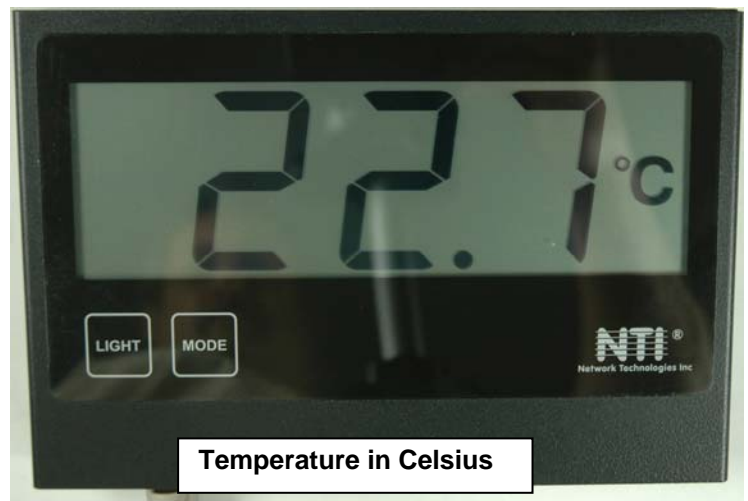
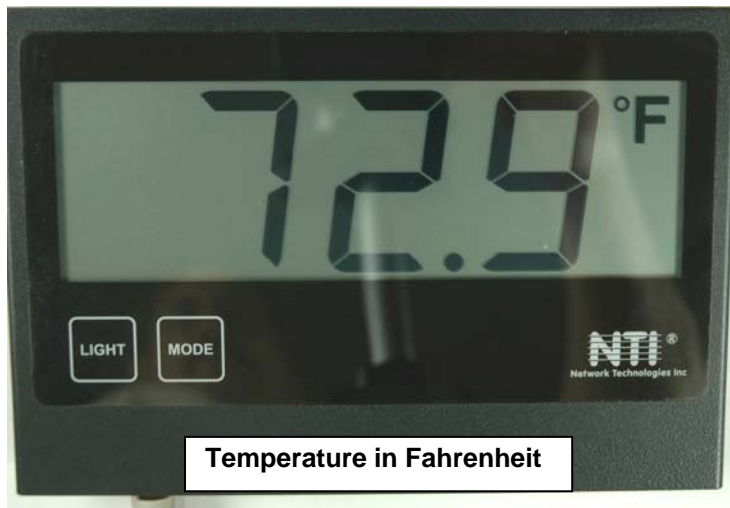
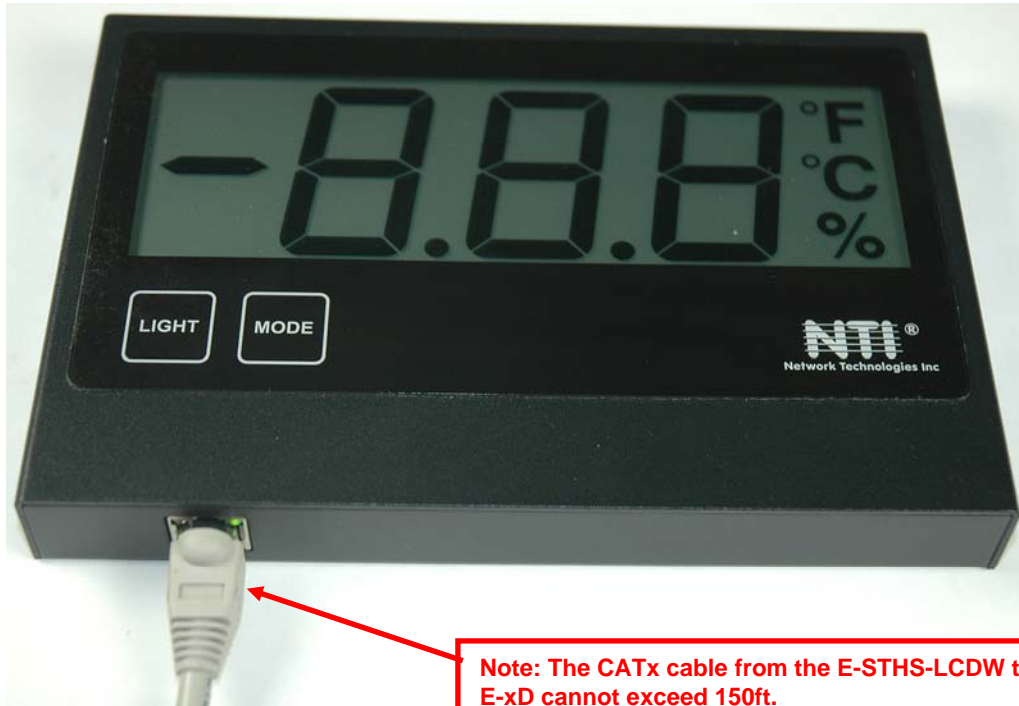

Figure 5- E-STHS-LCDW

To mount the sensor, use the hardware provided to secure the sensor to the wall (see pages 2- 3). Once it is mounted, connect a CATx cable between the RJ45 connector and the ENVIROMUX monitoring system.

## NTI ENVIROMUX TEMPERATURE/HUMIDITY SENSOR ATTACHMENT



**Note: The CATx cable from the E-STHS-LCDW to the E-xD cannot exceed 150ft.  
If longer than 150 foot cable is used, the MODE button will not function when the backlighting is ON**

The cable from the ENVIROMUX will attach to the sensor at the RJ45 port on the bottom of the E-STHS-LCDW. The E-STHS-LCDW will be powered by the ENVIROMUX Monitoring System through the CATx cable. We recommend using CAT5/5e/6/6a cable (minimum 24 AWG) up to 150 ft (45.7 m) long.

**Note: If a longer cable is used (up to 1000ft), the MODE button will not work when the display is illuminated by pressing the LIGHT button.**



## NTI ENVIROMUX TEMPERATURE/HUMIDITY SENSOR ATTACHMENT

### E-STS-O Outdoor Temperature Sensor Cable Restraint Assembly Procedure

The E-STS-O Outdoor Temperature Sensor includes a water-tight cable restraint to be applied to the Cat5/5e/6/6a shielded cable to be used to connect the sensor to an E-16D/5D/2D and E-SEMS-16(U) unit. To make sure the connection is water-tight upon completion, follow the steps below.



1. Insert the seal ring into the housing.

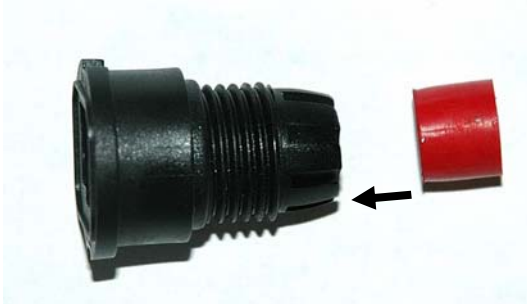

2. Strip the CATx shielded cable jacket (6mm-7mm O.D.) approximately 1/2" and insert the cable through the sealing nut, screw nut, and housing. (Note: Heat shrink tubing can be applied to cable to increase the O.D. of the CATx cable to 6mm-7mm.)

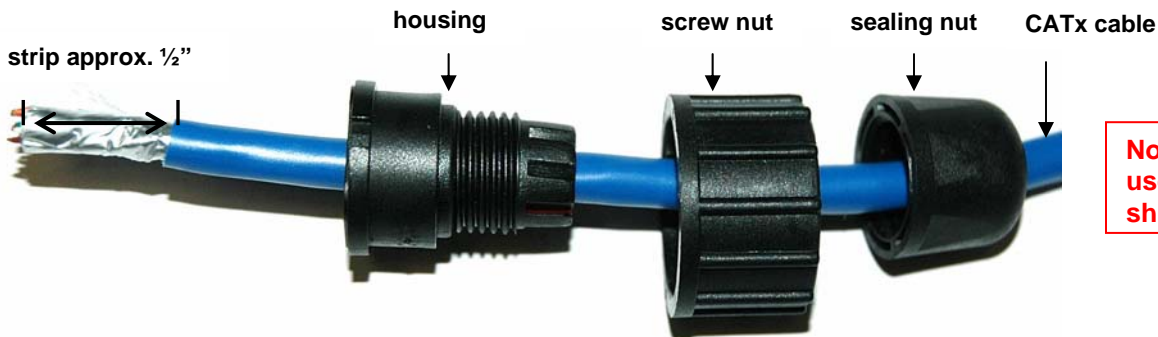

3. Terminate the CATx shielded cable with an RJ45 connector.



4. Set the RJ45 connector into the housing such that the snap handle is in the notch.

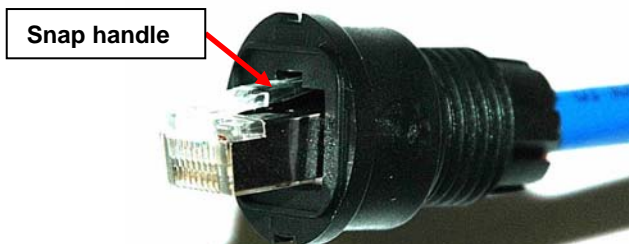

## NTI ENVIROMUX TEMPERATURE/HUMIDITY SENSOR ATTACHMENT

5. Make certain that the seal ring is fully-seated into the housing.

**THIS STEP IS EXTREMELY IMPORTANT TO ENSURE A WATER-TIGHT SEAL!**

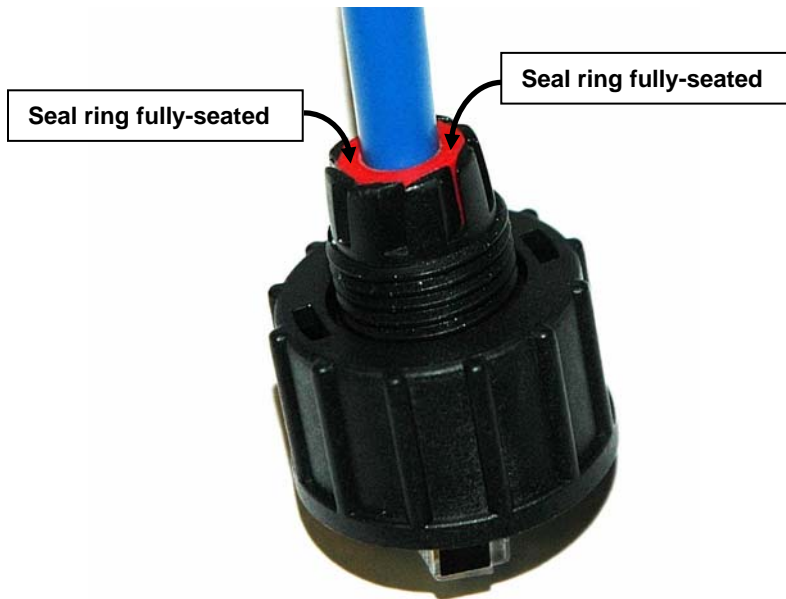

6. Plug the assembly into the socket on the E-STS-O and secure the screw nut. Then apply the sealing nut and securely tighten.



## NTI ENVIROMUX TEMPERATURE/HUMIDITY SENSOR ATTACHMENT

### Mounting

To mount the E-ST5-O, two brackets have been provided that are each secured with a screw (provided).

Install each bracket with the raised ridge towards the front of the sensor, so that the bracket sits flat and squarely against the sensor case.

**Do not overtighten screws or stripping of the case will occur.**

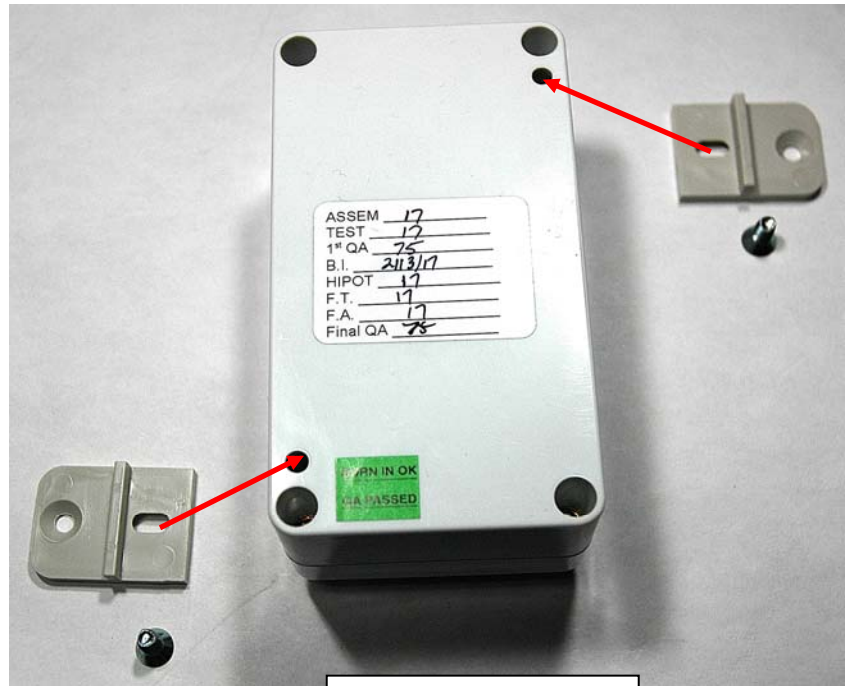

Brackets and screws ready to install.



Brackets and screws installed.

Sensor ready to mount



**NTI ENVIROMUX TEMPERATURE/HUMIDITY SENSOR ATTACHMENT**  
**TEMPERATURE AND HUMIDITY SENSORS**

SENSOR MODEL	OPERATING TEMPERATURE RANGE	HUMIDITY RANGE	ACCURACY
E-ST5	32 to 122°F (0 to 50°C)	n/a	±0.9°F (±0.5°C)
E-ST5-O	-40°F to 185°F (-40°C to +85°C)	n/a	±0.9°F (±0.5°C)
E-STSM-E7	-4 to 140°F (-20 to 60°C)	n/a	±1.26°F (±0.70°C) for -4 to 41°F (-20 to 5°C) ±0.72°F (±0.40°C) for 41 to 140°F (5 to 60°C)
E-STHS-LSH	-4 to 140°F (-20 to 60°C)	0 to 90% RH	±.90°F (±0.50°C) for -4 to 14°F (-20 to -10°C) ±0.72°F (±0.40°C) for 14 to 140°F (-10 to 60°C) Inflation due to self-heating <0.9°F (0.5°C) typical, 2.3°F (1.3°C) max. 10 to 80% RH, ±3%(30°C) 80 to 90% RH, ±4%(30°C)
E-STHSB	-4 to 185°F (-20 to 85°C)	<ul style="list-style-type: none"> <li>0 to 80% RH, ±3%(30°C)</li> <li>80 to 90% RH, ±4%(30°C)</li> </ul>	±.90°F (±0.50°C) for -4 to 14°F (-20 to -10°C) ±0.72°F (±0.40°C) for 14 to 185°F (-10 to 85°C)
E-STHSM-E7	-4 to 140°F (-20 to 60°C)	0 to 90% RH	±.90°F (±0.50°C) for -4 to 14°F (-20 to -10°C) ±0.72°F (±0.40°C) for 14 to 140°F (-10 to 60°C) 10 to 80% RH, ±3%(30°C) 80 to 90% RH, ±4%(30°C)
E-STHS-LCD(W)	-4 to 140°F (-20 to 60°C)	0 to 90% RH	±.90°F (±0.50°C) for -4 to 14°F (-20 to -10°C) ±0.72°F (±0.40°C) for 14 to 140°F (-10 to 60°C) 10 to 80% RH, ±3%(30°C) 80 to 90% RH, ±4%(30°C)
E-STHS-PRC	32 to 140°F (0 to 60°C)	10% to 80% RH	± 0.4°F(±0.2°C) ± 1.8%RH@86°F (30°C)
E-STSP E-STSP-SL-7	-40 to 185°F (-40 to 85°C)	n/a	±1.0°F (±0.5°C).

**Sensor Calibration**

All temperature/humidity combination sensors and humidity-only sensors are designed to be accurate within the specifications stated in the chart above. They are not designed to be re-calibrated. In the event you want the calibration of your sensor to be checked, please contact NTI for an RMA to return your sensor. Sensor accuracy will be checked for a nominal charge. Sensors within warranty that are found to be out of factory specification will be repaired or replaced at no additional charge. Normal labor or replacement charges will apply to sensors out of warranty and out of specification.

**Power Consumption**

All of our temperature and temperature/humidity sensors operate at 5VDC and draw between 10-56mA (the highest being the E-STHS-LCDW).

## NTI ENVIROMUX TEMPERATURE/HUMIDITY SENSOR ATTACHMENT

### Accuracy

The reported accuracy of these sensors is based on an environment of moving air. In a stagnant air environment, the sensor may read higher than actual temperature.

### Coverage

The coverage area for temperature/humidity sensors cannot be specified as there are too many variables that can affect the range in a sensor's environment.

### Behavior

When an E-STHS-xx, E-STHSB or E-STHSM-E7 is connected to an ENVIROMUX system, three sensors values will be reported for the connected port;

First will be displayed the observed temperature value of the sensor.

Second will be displayed the observed humidity value of the sensor.

Third, is a calculated value using the observed Temp and Humidity values called Dew Point. Dew point temperature is the value where 100% humidity would be achieved. If air and/or surface temperatures are below this value, condensation will occur.

Sensors					
Conn.	Description	Type	Value	Status	Action
1	<a href="#">E-16DEL E01-M Temperature 1</a>	Temperature/Humidity	86.0°F	Normal	<a href="#">View</a> <a href="#">Edit</a> <a href="#">Delete</a>
1	<a href="#">E-16DEL E01-M Humidity 1</a>	Temperature/Humidity	27%	Normal	<a href="#">View</a> <a href="#">Edit</a> <a href="#">Delete</a>
1	<a href="#">E-16DEL E01-M Dew Point Sensor 1</a>	Dew Point	47.9°F	Normal	<a href="#">View</a> <a href="#">Edit</a> <a href="#">Delete</a>

## Dew Point Measurement as it relates to Electronic Equipment

The dew point is the temperature at which air becomes saturated with water vapor.

When further cooled, the airborne water vapor will condense to form liquid water (Dew is an example).

The two primary factors influencing the Dew Point is Temperature and Relative Humidity. As the humidity rises the closer the Dew Point will be to the current temperature.

In a controlled environment it is important to keep condensation away from electronic equipment. Most electronic equipment will be susceptible to failure in a condensing environment.

Also in very low Dew Point environments static discharge events are more likely to occur, again putting electronic equipment at risk.

**Note:** For people, Dew Points higher than 21°C (70°F) and below -22°C (-8°F) are uncomfortable environments.

### Warnings and Alerts from the ENVIROMUX

Setting the Dew Point alerts will depend upon the environment that is being monitored.

An example would be an equipment room that normally operates at 21°C (70°F).

It may be desirable to be warned when the Dew Point reaches 19°C (66°F) and alerted when the Dew Point reaches 21°C (70°F) as condensation would become a high probability.

For low Dew Points, it may be desirable to be warned when the Dew Point reaches -1°C (30°F) and alerted when the Dew Point reaches -4°C (25°F) as these conditions would be perfect for static discharge events.

## NTI ENVIROMUX TEMPERATURE/HUMIDITY SENSOR ATTACHMENT

### RJ45 Sensor Cable

The CAT5 connection cable between the ENVIROMUX and connected external sensors is terminated with RJ45 connectors and must be wired according to the EIA/TIA 568 B industry standard. Wiring is as per the table and drawing below. The sensors that connect to "RJ45 Sensor" ports (E-16(U)/xD) are all designed to use cables wired to this standard.

Pin	Wire Color	Pair
1	White/Orange	2
2	Orange	2
3	White/Green	3
4	Blue	1
5	White/Blue	1
6	Green	3
7	White/Brown	4
8	Brown	4

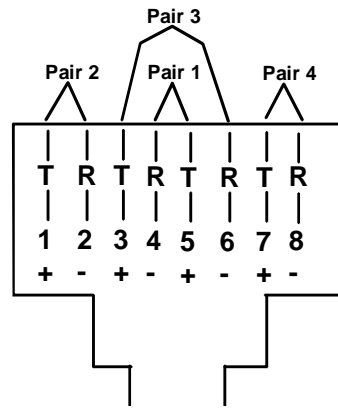

#### TRADEMARK

ENVIROMUX is a registered trademark of Network Technologies Inc in the U.S. and other countries.

#### COPYRIGHT

Copyright © 2008, 2019 by Network Technologies Inc. All rights reserved. No part of this publication may be reproduced, stored in a retrieval system, or transmitted, in any form or by any means, electronic, mechanical, photocopying, recording, or otherwise, without the prior written consent of Network Technologies Inc, 1275 Danner Drive, Aurora, Ohio 44202.

#### CHANGES

The material in this guide is for information only and is subject to change without notice. Network Technologies Inc reserves the right to make changes in the product design without reservation and without notification to its users.

MAN215 REV 6/21/2019