



**NETWORK  
TECHNOLOGIES  
INCORPORATED**

1275 Danner Dr    Tel:330-562-7070  
Aurora, OH 44202    Fax:330-562-1999  
www.networktechinc.com

**SPLITMUX® Series**

# SPLITMUX-DVI-4RT

## Quad Screen Video Splitter

### Installation and Operation Manual



## **TRADEMARK**

SPLITMUX is a registered trademark of Network Technologies Inc in the U.S. and other countries.

## **COPYRIGHT**

Copyright © 2007, 2020 by Network Technologies Inc. All rights reserved. No part of this publication may be reproduced, stored in a retrieval system, or transmitted, in any form or by any means, electronic, mechanical, photocopying, recording, or otherwise, without the prior written consent of Network Technologies Inc, 1275 Danner Drive, Aurora, Ohio 44202.

## **CHANGES**

The material in this guide is for information only and is subject to change without notice. Network Technologies Inc reserves the right to make changes in the product design without reservation and without notification to its users.

## **FIRMWARE VERSION**

4.11

## **WARRANTY INFORMATION**

The warranty period on this product (parts and labor) is two (2) years from the date of purchase. Please contact Network Technologies Inc at **(800) 742-8324** (800-RGB-TECH) or **(330) 562-7070** or visit our website at <http://www.networktechinc.com> for information regarding repairs and/or returns. A return authorization number is required for all repairs/returns.

## TABLE OF CONTENTS

<b>INTRODUCTION</b>	<b>1</b>
FEATURES	1
TECHNICAL SPECIFICATIONS	3
SAFETY GUIDELINES	4
HARDWARE	5
- FRONT PANEL	5
- LED indicators	5
- Buttons	6
- Additional button functions	7
- REAR PANEL	9
- Power / Ports	9
<b>INSTALLATION</b>	<b>11</b>
CONNECTING UNIT TO POWER	11
CONNECTING CONSOLE (MONITOR, KEYBOARD, MOUSE, TOUCH SCREEN, TRACKBALL)	11
CONNECTING SOURCES / COMPUTERS	12
CONNECTING USB DEVICES	12
POWERING UP THE SYSTEM	12
CONNECTING AUDIO	13
<b>ON SCREEN DISPLAY</b>	<b>14</b>
OSD - OVERVIEW	14
OSD - MAIN MENU WINDOW	16
OSD - NAVIGATION	17
OSD SYSTEM	18
- HDCP	18
- HOTKEY	19
- HOTMOUSE	20
- QUAD MODE	21
- WIN MODE	22
- OSD POSITION	23
- OSD LANGUAGE	23
- SECURITY	24
- DISABLE CHANNEL	27
- CONTROL - DCP control	28
- Example of DCP control	29
- DCP synchronize	29
- Example of DCP synchronization	30
- Security Levels	31
<b>OSD MODE</b>	<b>32</b>
- CURRENT	32
- START	32
- PIP	33
- WIN	37
- TEST PATTERN	38
<b>OSD CONFIGURATION</b>	<b>39</b>
- BACKUP	39
- RECALL	39



# TABLE OF CONTENTS

---

## TABLE OF CONTENTS

	- FACTORY RESET / DEFAULTS	40
<b>OSD CONSOLE</b>	- VIDEO OUTPUT	42
	- KEYBOARD	43
	- TOUCH SCREEN	44
	- MOUSE	47
	- FADE	47
	- MULTI MONITOR	48
	- BACKGROUND	49
	- EDID	50
<b>OSD VIDEO</b>	- INPUT STATUS	51
	- DVI/VGA	52
	- ROTATION	53
	- CROPPING	54
	- BRIGHTNESS / CONTRAST	55
	- HORIZONTAL/VERTICAL POSITION	56
	- SCREEN WIDTH	57
	- PHASE	57
	- FORMAT	58
<b>OSD COMPUTER</b>	- CHANNEL MAPPING	60
	- AUDIO	61
	- NAME 1-4	62
	- KEYBOARD	63
	- MOUSE	64
	- RESET PS/2	65
	- EDID/DDC	65
<b>OSD USB DEVICE 1-4</b>	- USB PORT STATUS	69
	- SWITCHING MODE	70
	- CHANGE DEVICE NAME	71
<b>OSD HELP</b>	- ABOUT/HOTKEY/CONTACT	72
<b>HOTMOUSE</b>		<b>73</b>
ACTIVATING HOTMOUSE CURSOR		73
HOTMOUSE CURSOR IN FULLSCREEN MODE / QUAD MODE		74
HOTMOUSE CURSOR IN PIP MODE		75
HOTMOUSE CURSOR IN WIN MODE		77
HOTMOUSE MENU	- ACTIVATING / OPERATING	79
	- MODE - QUAD	80
	- FULL	80
	- PIP	81
	- WIN	82
<b>SERVICE</b>		<b>83</b>
MAINTENANCE AND REPAIR - TECHNICAL SUPPORT		83

## TABLE OF CONTENTS

<b>ANNEX</b>	<b>84</b>
FCC DECLARATION	85
KEYBOARD COMMANDS	86
DEVICE CONFIGURATION PROGRAM	89
FIRMWARE UPDATE	93
SERIAL CABLE	95
DCP-XML REMOTE CONTROL	96
SUPPORTED TOUCH SCREEN CONTROLLER	97
SUPPORTED VIDEO INPUT	98
SUPPORTED VIDEO OUTPUT	99
CASCADING	100
BOX CONTENTS	103

## FEATURES

Thank you for choosing SPLITMUX-DVI-4RT from NTI. This product represents the latest state-of-the-art technology in keyboard-video-mouse (KVM) switching. The key advantage of the SPLITMUX-DVI-4RT (SPLITMUX) over conventional KVM switches is it allows you to simultaneously display and manage 4 computers on a single console. It combines key features of a high-end KVM switch and a digital multiviewer, scaling and converting videos at both inputs and output.

### DISPLAY MODES

#### Quad mode ►

In this mode, the screen is split into four fields of equal size; each displaying the entire screen contents of one source.

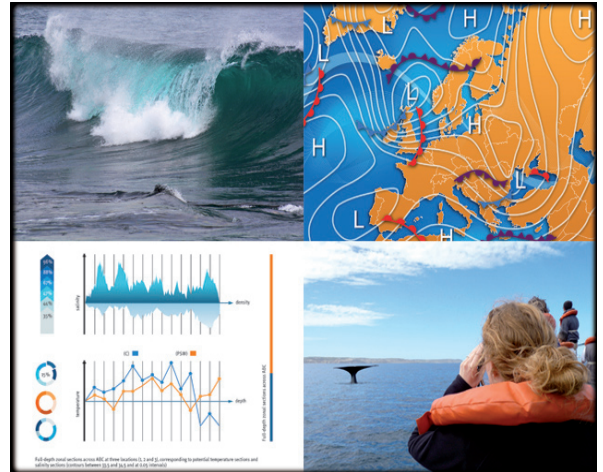

#### ◀ Fullscreen mode

In Fullscreen mode, one of the four sources is displayed in full screen size and maximum resolution.

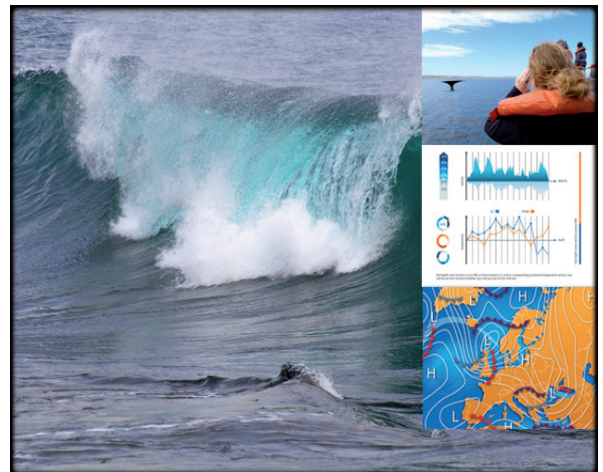

#### PiP mode (Picture in Picture) ►

Using this feature, the full screen display of one of the four video sources is accompanied by one to three small images (thumbnails) of the other video sources which are displayed on the right hand side of the screen allowing simultaneous monitoring.



#### ◀ Win mode

In Win mode each video source is displayed in its own separate, detached window. Each of these windows can be freely positioned and their height and width can be adjusted. Transparency can be set. Positioning is done using either the Hotmouse function, the front panel or the touch screen. Presets of the window positioning can be saved.

# INTRODUCTION

---

## FEATURES

### DVI & VGA

SPLITMUX supports resolutions of up to 1920 x 1200 @ 60 Hz for both DVI and VGA.

Any combination of VGA and DVI at all standard resolutions is possible at inputs and output. Analog video input is converted to digital. If an analog display is connected, SPLITMUX converts the digital signal to analog at the output. Internally, SPLITMUX processes video **purely digital** guaranteeing superior digital image quality.

### USB & PS/2 for keyboard / mouse / touch screen / trackball

Use either PS/2 or USB ports on the computer to connect keyboard and mouse to SPLITMUX. It supports any combination. To connect the console, SPLITMUX features two USB ports for mouse, keyboard, touch screen or trackball connection.

### Transparent USB 2.0

SPLITMUX features a transparent high speed USB 2.0 matrix: USB 2.0 devices (e.g. printer, external memory, memory stick, webcam, 3D mouse, finger printer) can be switched to computers connected.

### Operation

There are six ways to operate SPLITMUX, switch channels, and select display modes:

1. Using the buttons on the front of the unit
2. Using configurable hotkeys (default HOTKEY is <Ctrl> + <Alt>)
3. Using the unit's external configuration software on a remote computer
4. Via a serial port using the protocol DCP XML
5. Using mouse functions (Hotmouse)
6. Using a touch screen

The configuration of SPLITMUX is carried out by means of an On Screen Display (OSD) that can be opened and navigated either with keyboard commands, front panel buttons or remotely via ConfDev on an external PC.

The LEDs on the front panel indicate the unit's current status.

Use the serial (RS232) or USB port for remote control and firmware updates.

**TECHNICAL SPECIFICATIONS**

<b>Casing:</b>	Desktop or 19", black (RAL 9005)
<b>Dimensions WxDxH:</b>	43.6 x 23.4 x 4.4 cm
<b>Weight:</b>	2.9 kg
<b>Operating controls:</b>	Front panel: 4 channel selection buttons, 1 Fullscreen mode button, 1 Quad mode button, 1 PiP mode button, 1 Win mode button Rear panel: One Power On/Off switch
<b>Indicators:</b>	Four active channel indicator LEDs, 1 Fullscreen mode LED, 1 Quad mode LED, 1 PiP mode LED, 1 Win mode LED
<b>Computer ports:</b>	4 DVI-I (analog and digital), 4 PS/2, 4 USB
<b>Console ports:</b>	1 DVI-I, 2 USB for keyboard and mouse
<b>USB 2.0 ports:</b>	4 transparent high-speed USB 2.0
<b>Audio:</b>	3,5mm analog stereo jack, digital cinch connector, TOSLINK optical audio
<b>Maximum distance:</b>	Video (DVI / VGA) up to 20 meters; keyboard / mouse up to 5 meters
<b>Input and output resolution:</b>	up to 1920 x 1200 @ 60 (DVI and VGA) *
<b>EDID adjustments:</b>	EDID at each input port customizable
<b>Supported keyboard layouts:</b>	German, English, French, Italian, Spanish, Japanese
<b>OSD languages:</b>	German, English, Spanish
<b>Power supply:</b>	Internal AC adapter, 100 to 240V 50/60 Hz
<b>Power consumption:</b>	40 watts
<b>Operating temperature:</b>	5 to 45°C
<b>Storage temperature:</b>	-10 to 60 °C
<b>Rel. humidity:</b>	5 to 65% non-condensing

\*(at WUXGA: reduced blanking only - WUXGAr)



# INTRODUCTION

---

## SAFETY GUIDELINES

### **WARNING:**

To avoid risk of electric shock do not open the device or remove any part of the casing. Please contact our technical support if the device requires servicing.

Please read this manual carefully before putting the device into operation.

Observe all warnings and instructions on the device and in the operation manual. Keep this user manual for future reference.

### **Power supply:**

Only connect the device to a grounded power supply.

### **Installation:**

Ensure that the device is disconnected from the mains before performing any installation work. Unplug the device or disconnect the power supply.

### **Cables:**

Only use the cables supplied by NTI with the device.  
Damage resulting from the use of third-party cables is not covered by warranty.  
Beware of tripping hazards when laying cables.

### **Location:**

Electronic devices should never be placed on the ground between the cables.  
Never obstruct any vents the device may have.  
Ensure adequate ventilation.

### **Maintenance:**

This device is maintenance-free.  
Never open the casing.  
No settings can be made inside the device.

## HARDWARE

### FRONT PANEL

The SPLITMUX front panel has eight status indicators (LEDs) and eight buttons.

Buttons 1 to 4 switch between channels, LEDs 1 to 4 indicate the status of the individual channels. **Full**, **Quad**, **PiP** and **Win** buttons LEDs are used to switch and indicate display modes and other functions, e.g. opening the OSD menu.



### LED indicators

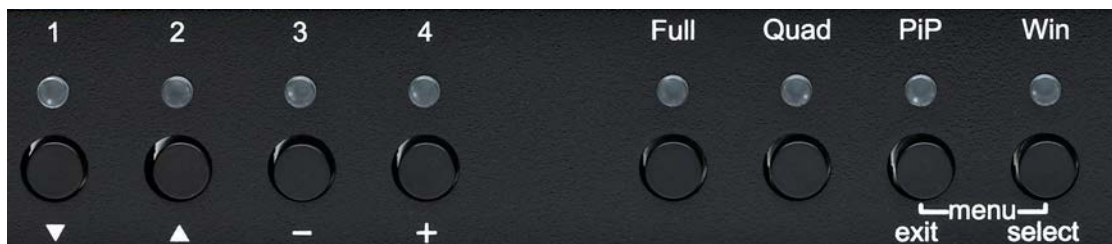

- LEDs 1 to 4:
  - When these LEDs light up **green**, the corresponding channel (computer port) has been selected and is available for keyboard and mouse access. When a LED flashes green, there is no signal at the video input of the selected channel.
  - An LED lights up **yellow** when there is a signal at the video input, but another channel has been selected.
  - When the LED is **dark**, there is no signal at the video input and another channel has been selected.
  - The LEDs light up **blue** when Win Mode preset window configuration is being selected.
- LED **Full**: This LED lights up **green** when the unit is in Fullscreen mode.
- LED **Quad**: This LED lights up **green** when the unit is in Quad mode.
- LED **PiP**: This LED lights up **green** when the unit is in PiP mode.
- LED **Win**: This LED lights up **green** when the unit is in Win mode.

**Note:** While the OSD menu is open, the active computer can still be operated by mouse or touch screen.

# INTRODUCTION

## HARDWARE

### FRONT PANEL (continued)

#### Buttons



- Buttons 1 to 4: These buttons activate the corresponding channel (computer port).
- Full button: Press to switch to Fullscreen mode.
- Quad button: Press to switch to Quad mode.
- PiP button: Press to switch to picture in picture mode (PiP).
- Win button: Press to switch to Win mode.

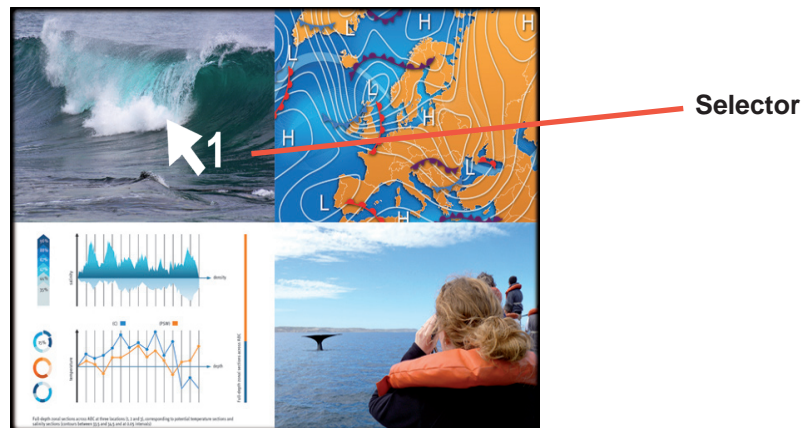

You can also select the active channel using hotkey and the arrow keys.  
The selection window closes once the channel selection timeout period has expired.  
The channel selection timeout is configured in the OSD under SYSTEM > QUAD MODE.  
Use the "Time out of channel selection:" menu item to define how long the selector is to be displayed.

**HARDWARE****FRONT PANEL - Additional button functions****Setting output resolution to safe output modes**

To set output resolution to 640 x 480 pixel @ 60 Hz simultaneously:

Press and hold buttons **1** and **2** for 2 seconds.

Use of this feature is recommended when you cannot use the OSD (on screen display dark or illegible) because the output resolution setting is not supported by the monitor. After setting the correct output resolution (640x480@60), you can choose a resolution the connected monitor supports in the OSD.

Alternatively, hold buttons 1 and 2 again to cycle through the following video modes: VGA 640x480@60, SVGA 800x600@60, XGA 1024x768@60, UXGA 1600x1200@60, and the preferred video resolution found in the monitor EDID.

LEDs 1 to 4 and FULL indicate the selected mode in blue.

**Hardware Reset**

Press and hold buttons **3** and **4** simultaneously for 5 seconds in order to reset the unit completely (video + mouse + keyboard)



# INTRODUCTION

---

## HARDWARE

### FRONT PANEL - Additional button functions

#### Calling up OSD

Press and hold **PiP** and **Win** buttons simultaneously for 2 seconds to open the OSD menu.



**Note:** While the OSD menu is open, the active computer can still be operated by mouse and touch screen.

**HARDWARE**

**REAR PANEL**

The rear panel of SPLITMUX features three audio ports, four input source/computer ports, the console port (KVM), the USB control port, the serial RS232 control port, four transparent high-speed USB 2.0 device ports, the power connection.

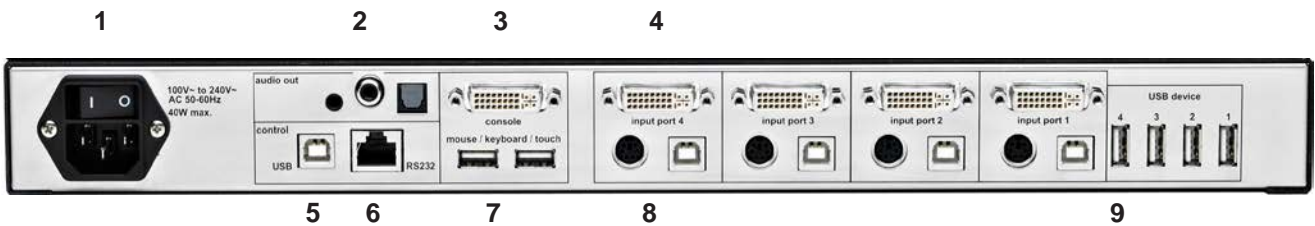

1	Power
2	Audio ports
3	Monitor / DVI-I output
4	Four DVI-I inputs
5	USB control port
6	RS232 / RJ45 control port
7	USB for keyboard, mouse, touch or trackball (console)
8	USB or PS2 keyboard and mouse (computer)
9	Four transparent high-speed USB 2.0 ports

**1. Power**

Plug for enclosed power cable.

**2. Audio ports**

Connect external speakers or headphones to the 3,5mm analog stereo jack or digital cinch connector. The TOSLINK optical audio connection enables digital audio output.

**3. Monitor / DVI-I output**

Analog or digital displays connect to this port.

**4. DVI-I inputs**

Analog or digital video signal of your up to four sources connect to these four DVI-I ports.

**5. USB control port**

External USB control devices connect to this port to operate SPLITMUX remotely. Execute firmware updates or manage the device using ConfDev by means of the control ports.

## HARDWARE

### REAR PANEL (continued)

#### 6. RS 232 / RJ45 control port

Connect external serial control devices to this RJ-45 port to operate SPLITMUX remotely, e.g. connect to this port to access the OSD menu from a computer using the ConfDev device configuration tool (see page 89).

The serial RS 232 port is also used for firmware updates (see page 93).

#### 7. USB for keyboard, mouse, touch or trackball (console)

Two USB ports allow connecting keyboard, mouse, touch screen or trackball.

Using a USB-Hub, you can connect **multiple** keyboards and mice. They will work in share mode with an inactivity timeout of 3 seconds.

#### 8. USB or PS2 keyboard and mouse (computer)

Each computer can be connected with PS/2 or USB-B for keyboard and mouse.

#### 9. Four transparent high-speed USB 2.0 ports

USB devices (printer, memory stick, finger printer, 3D mouse) are connected to the four transparent USB ports. This transparent USB 2.0 matrix switches USB 2.0 peripherals to computers connected to SPLITMUX.



## INSTALLATION

To reduce the need for long cables, SPLITMUX is best placed as close as possible to its video sources. By default, SPLITMUX is delivered as desktop version. Using the rack mount kit supplied, it may also be mounted in a 19" rack.

Keyboard, monitor, mouse (console) and USB devices are connected to SPLITMUX using the corresponding cables (DVI, USB or PS/2). KVM extenders will allow you to work remotely via CAT5, fiber optic or Ethernet connection.



### CONNECTING THE UNIT TO POWER

Plug the power cable into the power plug located on the rear panel of SPLITMUX, but do not turn the power on

### CONNECTING CONSOLE (MONITOR, KEYBOARD, MOUSE, TOUCH SCREEN, TRACKBALL)

Connect your monitor to the monitor port of SPLITMUX via VGA-DVI cable (analog) or DVI cable (digital) up to 20 meters. For greater distances use a DVI or VGA extender.

Connect your USB mouse and keyboard to the USB-A ports on the console up to 5 meters. For greater distances use a KVM or USB extender.

PS/2 mouse and keyboard can be connected to SPLITMUX using a PS/2-USB adaptor.

Connect your touch screen to the DVI-I port and the USB-A port (for calibration see page 44)

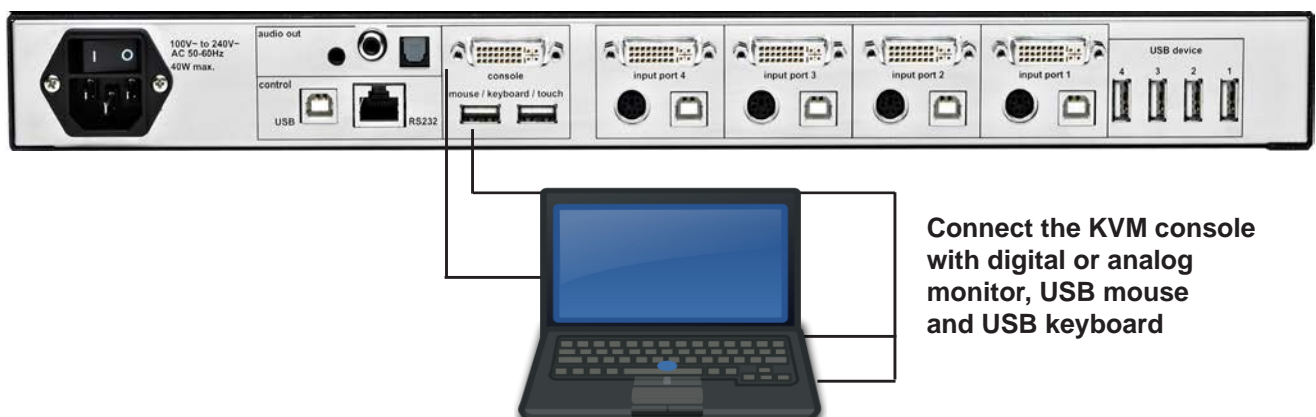

**Note:**

Maximum cable length for video (DVI / VGA) is up to 20 meters. Maximum cable length for USB / PS2 keyboard and mouse is up to 5 meters. For greater distances SPLITMUX supports most KVM extenders, video (DVI / VGA) extenders, and USB extenders.



# INSTALLATION

## INSTALLATION

### CONNECTING VIDEO SOURCES / COMPUTERS

Switch off the computer and disconnect the keyboard, monitor and mouse.

Connect keyboard and mouse ports of SPLITMUX to the computer ports either with a single USB cable or via the PS/2 interface (use the Y cable) up to 5 meters. For greater distances use a KVM or USB extender.

To connect an analog video / computer source (VGA) to SPLITMUX, use a VGA-DVI cable. Digital video sources are connected via a DVI cable up to 20 meters. For greater distances use a DVI or VGA extender.

### CONNECTING USB DEVICES

Connect a USB device to one of the four transparent USB ports to switch it to computers connected to SPLITMUX.

SPLITMUX supports transparent USB devices such as printer, external memory, 3D mouse, and finger printer.

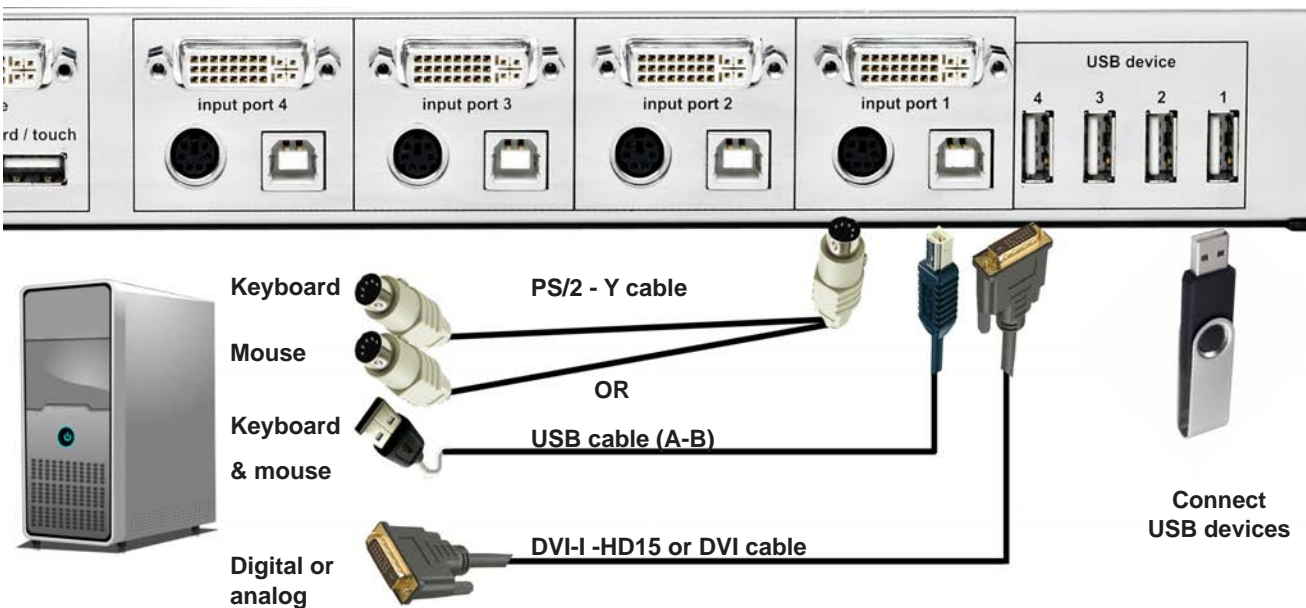

### POWERING UP THE SYSTEM

Switch on SPLITMUX with the power switch on the rear panel. All front panel LEDs light up briefly indicating that SPLITMUX is ready for operation. SPLITMUX is now in Quad mode (default).

Power up all connected computers. SPLITMUX recognizes all input video sources automatically and displays them on your monitor screen.

To select another display mode, use the relevant keyboard commands (see page 86) or buttons on the front panel (page 6).

**INSTALLATION**

**CONNECTING AUDIO**

The SPLITMUX can be connected to external, powered speakers or audio devices in order for sound coming from the four connected sources to be played back.

Three different connection options are made available (see graphic):

- 1) 3,5mm analog stereo jack
- 2) Digital cinch connector
- 3) TOSLINK optical audio jack

After the speakers have been physically connected to the SPLITMUX

- Open the OSD and navigate to COMPUTER > AUDIO
- Enable audio output
- Select the audio source and adjust the volume.

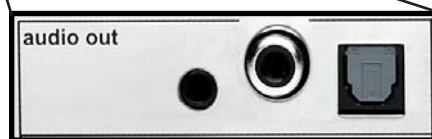

A variety of device options are available to connect to SPLITMUX for audio output

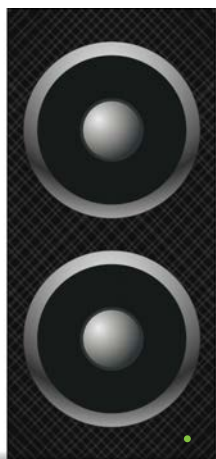

**Powered speakers**

1 2 3



**Headphones**



**Amplifier**

**Note:** Powered speakers or headphones can also be connected directly to SPLITMUX, eliminating the need for an amplifier.

# ON SCREEN DISPLAY

## OSD - OVERVIEW

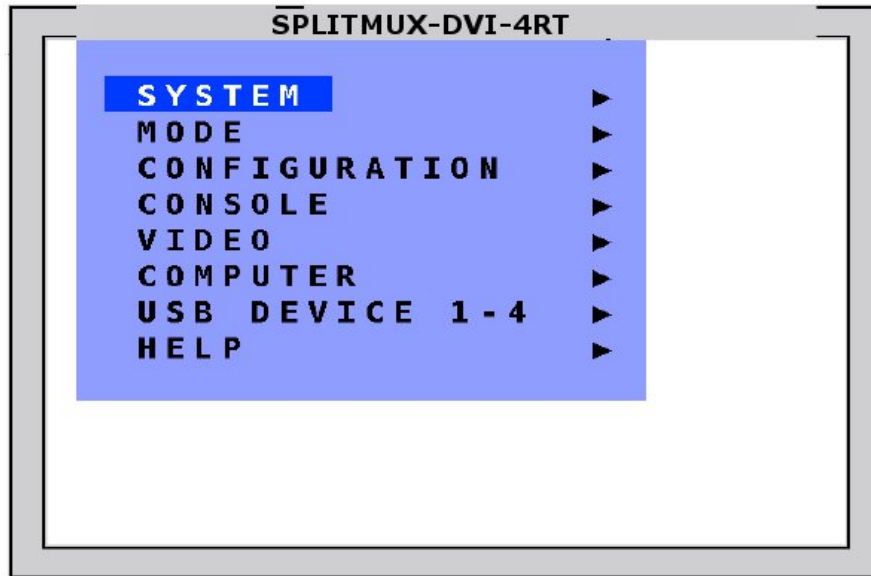

<b>SYSTEM</b>	HDCP HOTKEY HOTMOUSE QUAD MODE WIN MODE OSD POSITION OSD LANGUAGE SECURITY DISABLE CHANNEL CONTROL	HDCP status Multiple Hotkey / Double Click Hotkey Hotmouse Recognition, Hotmouse Timeout Channel Selection Timeout Appearance settings for windows Position of OSD window German / English / Spanish Set security level Deactivate unused channels Device control via DCP-XML protocol (RS232)
<b>MODE</b>	CURRENT START	Set the current channel and mode Set the channel and mode in which the device should boot
<b>CONFIGURATION</b>	BACKUP RECALL FACTORY RESET	Save configuration settings Restore last saved configuration Reset to factory default settings
<b>CONSOLE</b>	VIDEO OUTPUT KEYBOARD TOUCH SCREEN FADE MULTI MONITOR BACKGROUND EDID	Video resolution and frequency Keyboard layout Calibration / Mouse key emulation / Enlarge on touch Indicate use of smooth transitions Assign mouse/keyboard to video Select background type Display of EDID monitor data
<b>VIDEO</b>	INPUT STATUS DVI / VGA ROTATION CROPPING BRIGHTNESS CONTRAST HORIZ POSITION VERT POSITION SCREEN WIDTH PHASE FORMAT	Display computers' video input resolutions Choose input signal: DVI/VGA - DVI - VGA Rotate the screen display at different degrees Crop the display of video sources Set brightness of analog input signal Set contrast of analog input signal Horizontal screen position Vertical screen position Set screen width of analog input signal Adjust phase of analog input signal Fit input format to screen

**OSD - OVERVIEW (continued)**

<b>COMPUTER</b>	CHANNEL MAPPING	Assign an input port to a channel
	AUDIO	Enable audio output / Audio source selection / Volume
	NAME 1-4	Assign computer names
	KEYBOARD	Display type of keyboard (PC1, PC2, PC3 or USB)
	MOUSE	Display type of mouse (PS/2, PS/2 Wheel or USB)
		Set USB mouse positioning (absolute / relative)
<b>USB DEVICE 1-4</b>	RESET PS/2	Reset PS/2 mouse and keyboard
	EDID / DDC	Program input EDID
	USB PORT STATUS	Shows USB 2.0 matrix status and allows USB ports to be assigned to a device
<b>HELP</b>	ABOUT	Firmware / hardware version, serial number, etc
	HOTKEY	List of keyboard commands
	CONTACT	Contact information

# ON SCREEN DISPLAY

## OSD - MAIN MENU WINDOW

There are three ways to open the OSD main menu (figure):

- use keyboard command „hotkey“ + „O“
- simultaneously press front panel buttons „PiP“ + „Win“ for longer than one second
- remotely open the OSD via ConfDev program on an external PC with serial or USB connection

**1** Call the OSD by pressing buttons „PiP“, + „Win“, simultaneously for longer than one second



**On Screen Display (OSD)**  
The OSD pops up in the center of the screen (on top of the video image).

**2** Press Hotkey + O on your computer keyboard

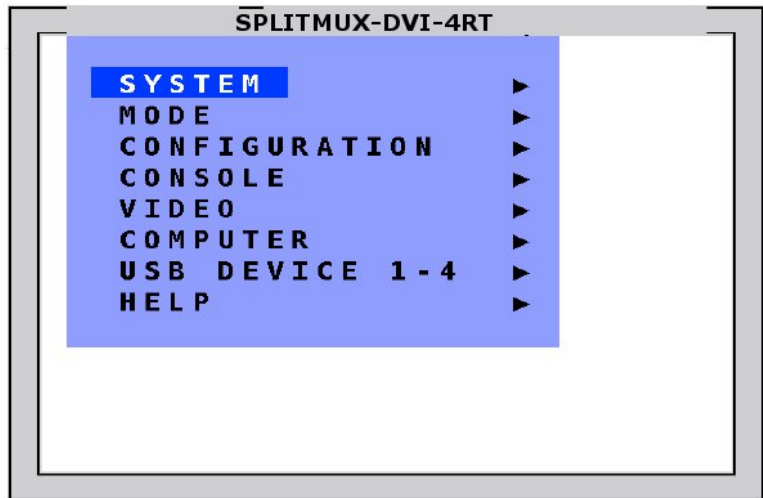

**3** Use a serial or USB connection from a PC to SPLITMUX to remotely open the OSD using ConfDev.



## OSD - NAVIGATION

To navigate the On Screen Display (OSD) either use the buttons on the front panel or your keyboard.

### Navigation with keyboard

To navigate from one field to the next in the OSD menu use the UP and DOWN arrow keys or TAB/SHIFT-TAB keys. Use the LEFT and RIGHT arrow or + (PLUS) and - (MINUS) keys to change the value in the current field. Press ENTER to select a menu item.

Press ESC to return to the previous window (higher menu level) or exit the OSD. Changes in parameters are saved automatically.

### Navigation using the buttons on the front panel



Corresponding keys on console keyboard

Navigation using the buttons on the front panel is analogous to using the console keyboard. Buttons **1** and **2** correspond to the UP and DOWN arrow keys and buttons **3** and **4** to the LEFT and RIGHT arrow keys or +/- keys. Confirm your entry by pressing the **Win / select** button.

Press the **PiP / exit** button to return to the previous page (higher menu level) or exit the OSD. Changed settings are saved automatically.

**Note:** Hotkey commands are possible while the OSD window is open.

# ON SCREEN DISPLAY

## OSD - SYSTEM - HDCP

### HDCP STATUS

Use the arrow keys to navigate in the SYSTEM menu to the entry HDCP and press ENTER/SELECT to open the HDCP window.

The SYSTEM / HDCP window displays the status of HDCP input and output encoding. HDCP (High-bandwidth Digital Content Protection) is an encoding system used to secure and transmit audio and video.

In the upper part of the window, the HDCP status of the four input signals is displayed. When a checkbox is marked, the source is transmitting an HDMI signal with HDCP encoding.

SPLITMUX displays this signal only when HDCP encoding is capable of being activated on the output device as well.

The lower portion of the window displays the HDCP status of the output. The first line shows whether the monitor connected supports HDCP.

When checked, the next line indicates whether the signal proceeding from SPLITMUX is protected by HDCP. If the output signal is HDCP encoded, SPLITMUX puts out neither analog video signal nor any separate audio signal.

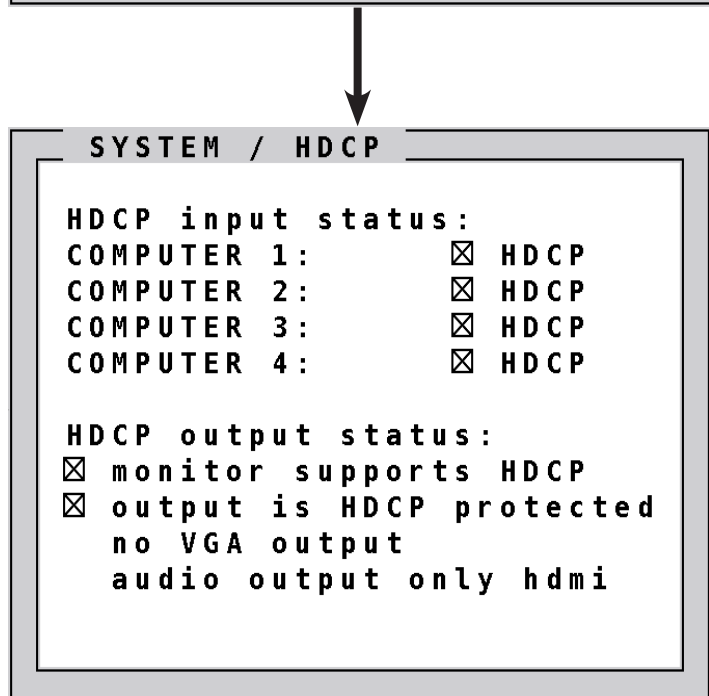
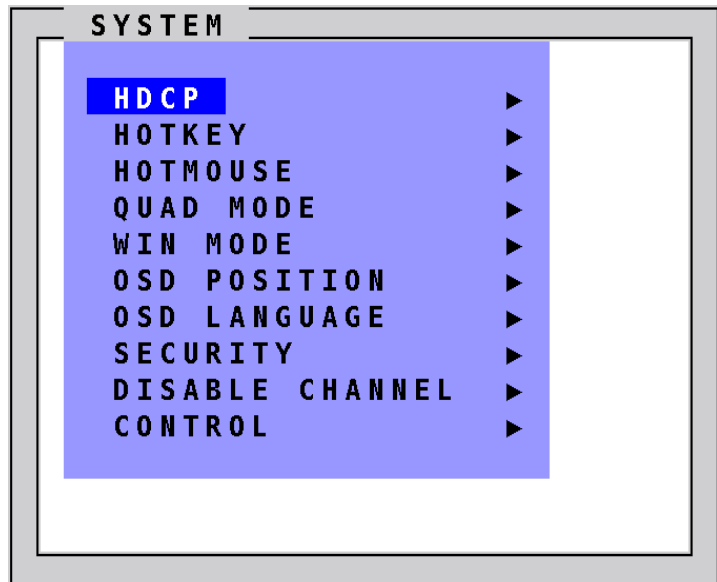

**OSD - SYSTEM - HOTKEY**

**HOTKEY**

Navigate with the arrow keys in the SYSTEM menu to the entry HOTKEY and press the ENTER/SELECT key to open the HOTKEY window.

Two different hotkey modes are available:

- For multiple hotkey commands you can define one to four keys which are pressed simultaneously to enter the command mode. Selectable keys are: CTRL, SHIFT, ALT and WINDOWS (default is CTRL + ALT).
- For double click hotkey commands you can choose one key, which is double clicked (pressed twice quickly) to enter the command mode. Selectable keys are: CTRL, SHIFT, ALT and SCROLL.

To change the hotkey mode or select another hotkey, navigate with the TAB or ARROW UP/DOWN keys to the respective field and use the ARROW LEFT/RIGHT or the +/- keys to change the setting.

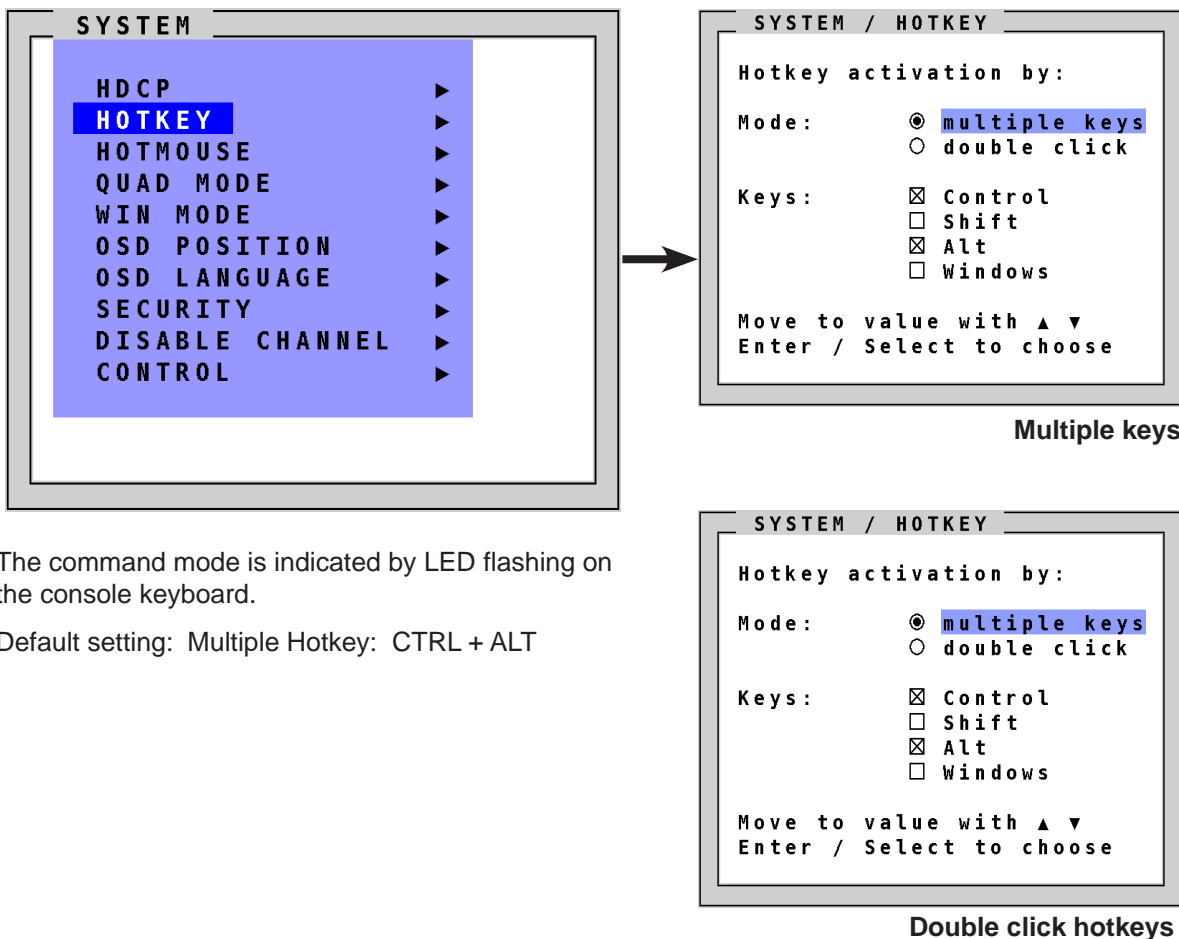

The command mode is indicated by LED flashing on the console keyboard.

Default setting: Multiple Hotkey: CTRL + ALT

For a list of hotkeys to operate SPLITMUX, see Annex page Keyboard Commands.



## ON SCREEN DISPLAY

### OSD - SYSTEM - HOTMOUSE

#### HOTMOUSE FUNCTION

Navigate with the arrow keys in the SYSTEM menu to the entry HOTMOUSE and press ENTER/SELECT to open the HOTMOUSE window.

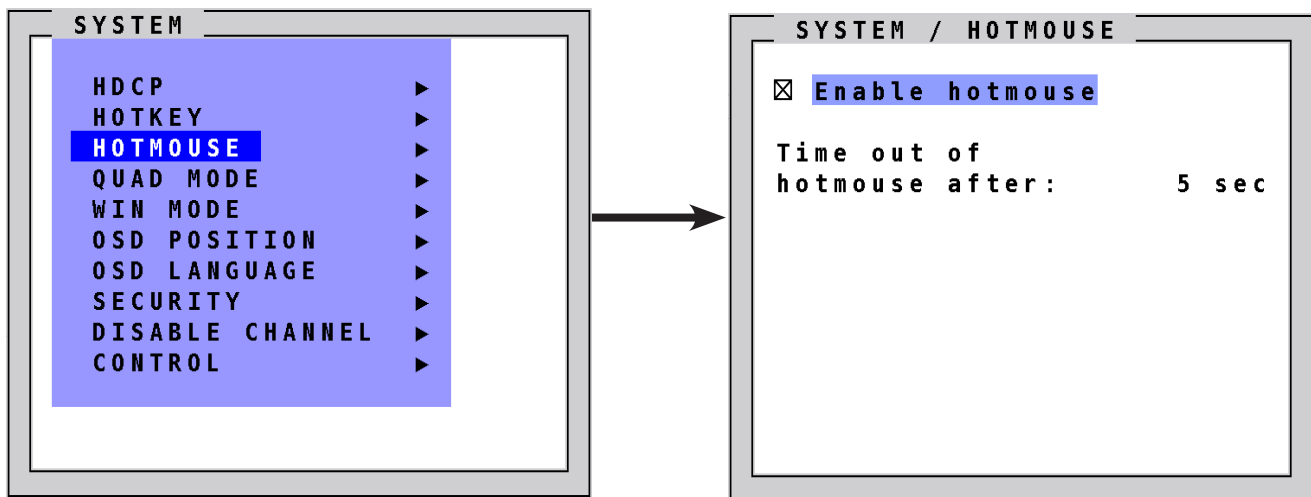

Hotmouse is an exclusive function that comes with NTI SPLITMUX. It works with your standard mouse or trackball.

To activate Hotmouse operation:

- Navigate to "Enable Hotmouse"
- Change the setting to "Yes".

There are two modes of Hotmouse operation: **Hotmouse Cursor** and **Hotmouse Menu**.

While **Hotmouse Cursor** supports only a limited set of operations, **Hotmouse Menu** allows execution of all switch operations and display mode settings.

While the Hotmouse function is activated, the active computer can still be operated by keyboard.

For a detailed description of Hotmouse, Hotmouse functionalities, and Hotmouse Menu please see chapter HOTMOUSE.

**OSD - SYSTEM - QUAD MODE**

**QUAD MODE**

Use arrow keys to navigate in the SYSTEM menu to the entry QUAD MODE and press ENTER/SELECT to open the QUAD MODE window.

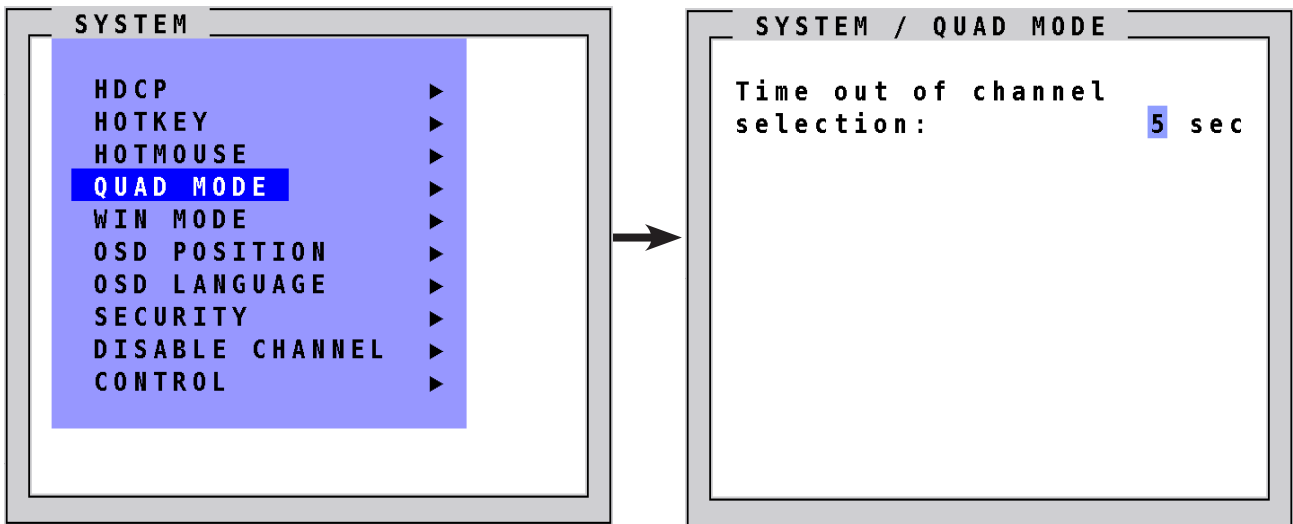

Channel selection timeout defines the period (1 to 30 seconds) after which the selector will close automatically. Default setting is 5 seconds.



To open the active channel in Quad mode

Press **hotkey 'Q'**

The yellow border indicates the active channel (mouse and keyboard enabled). Alternatively, press front button "Quad".

To switch the selector from an active channel to another

Press **hotkey + arrow key**

After the selector timeout has expired, the selector closes.

# ON SCREEN DISPLAY

## OSD - SYSTEM - WIN MODE

### WIN MODE

Navigate with the arrow keys in the SYSTEM menu to the entry WIN MODE and press ENTER/SELECT to open the Win mode window.

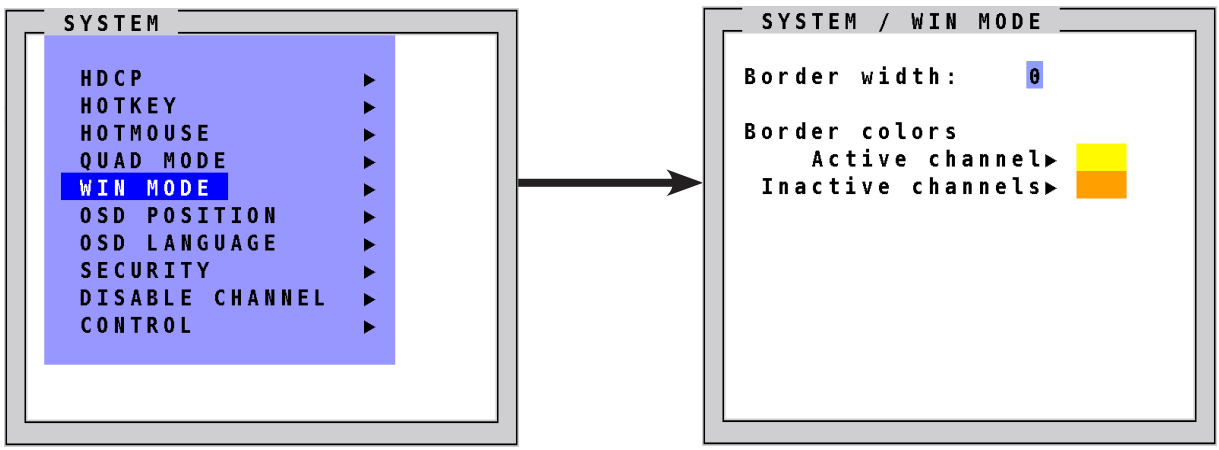

**Border width:** Set the width of the borders, which are drawn around the signals in Win mode. When the border width is zero, no borders are shown.

#### Border colors:

- Active channel: Press enter /select to open the SELECT COLOR menu and set the color for the active channel.
- Inactive channels: Press enter /select to open the SELECT COLOR menu and set the color for the inactive channels.



**Selector**  
In Win mode, use **hotkey '1-4'** to select a channel or window. (Alternatively, the hotmouse function or front panel buttons 1-4 can be used to select a channel or window as well.) When a channel has been selected, a colored border will appear around the window of the active channel. The selector will also be visible. Alternatively, press front button "Win" and select a preset.  
After the expiration of the selector timeout, the selector closes.

#### Pop Up Buttons

Move the hotmouse cursor to the top right corner of the signal window, and the following buttons will appear:

- O** = Open OSD hotmouse context menu
- S** = Swap signal windows. After this is selected, the other window is clicked.
- R** = Toggle aspect ratio locking for current window

**OSD - SYSTEM - OSD POSITION / OSD LANGUAGE**

**OSD POSITION**

Navigate with the arrow keys in the SYSTEM menu to the entry OSD POSITION and press ENTER/SELECT to open the OSD POSITION window.

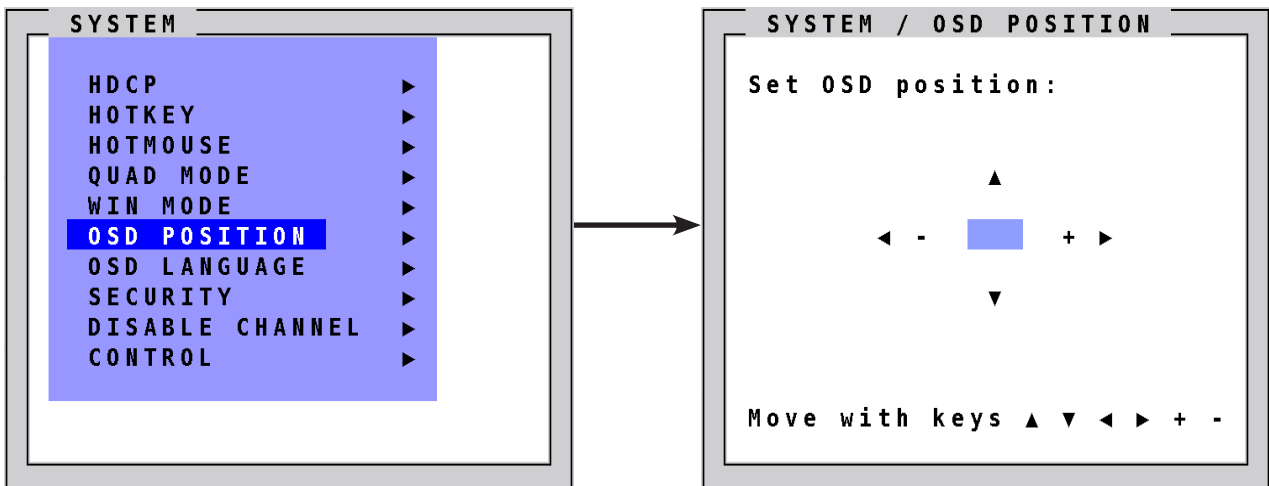

Use this function to move the OSD window to any position on the screen.

**OSD LANGUAGE**

Navigate with the arrow keys in the SYSTEM menu to the entry OSD LANGUAGE and press ENTER/SELECT to open the OSD LANGUAGE window.

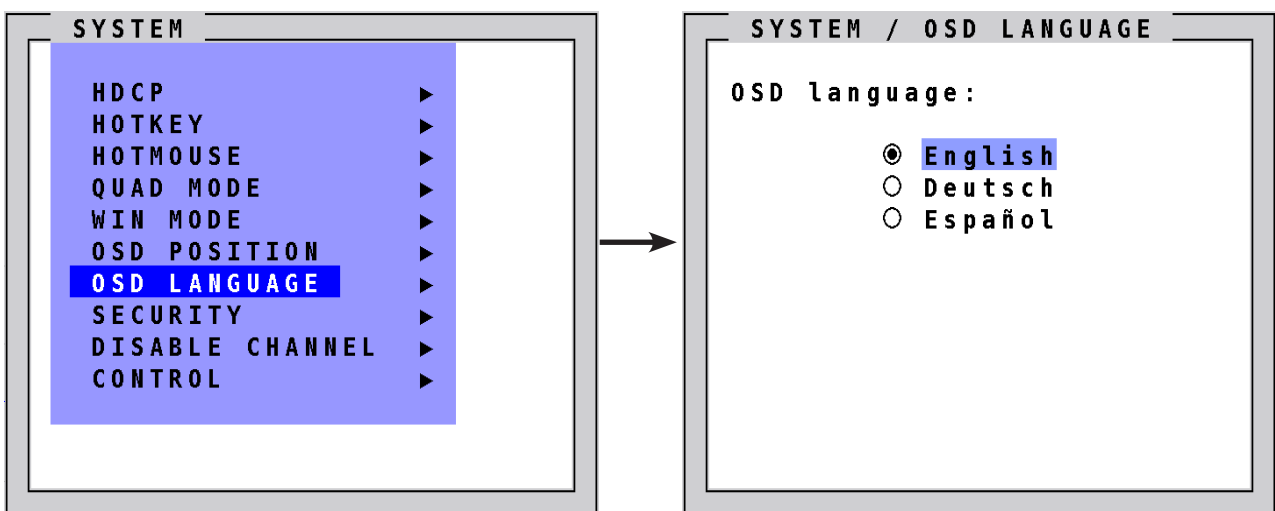

Set OSD LANGUAGE to either English (default), Deutsch (German) or Español (Spanish).

# ON SCREEN DISPLAY

## OSD - SYSTEM - SECURITY

### SECURITY LEVELS

Navigate with the arrow keys in the SYSTEM menu to the entry SECURITY and press ENTER/SELECT to open the SECURITY window.

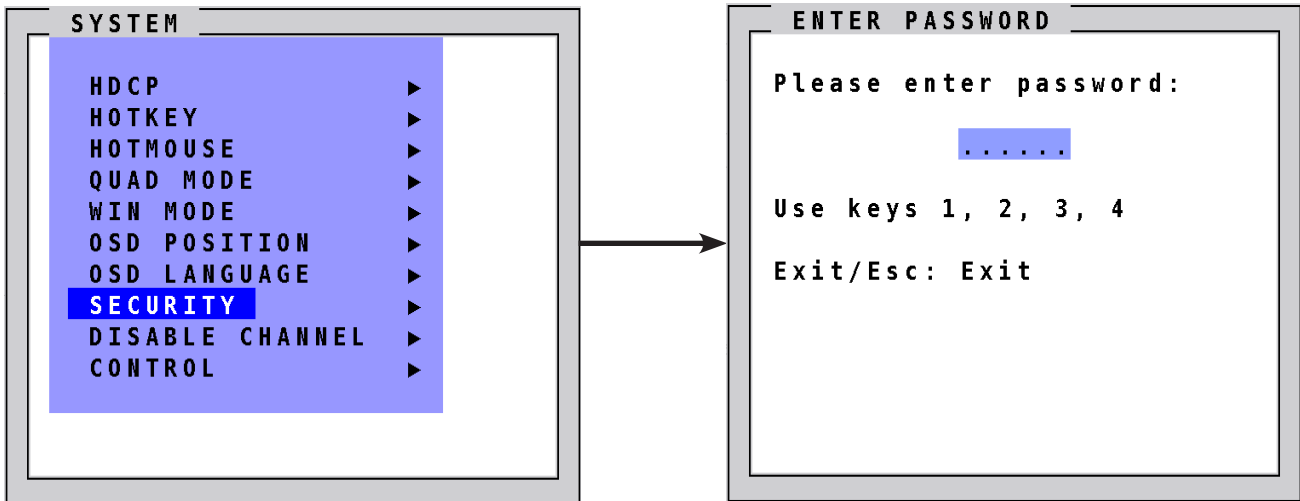

The SECURITY feature allows you to reduce the functional range of SPLITMUX. Eight security levels are available for this purpose.

By default, all functions are enabled (security level 0). To change the security level, you must first enter a predefined password. This six-digit password is enclosed separately with the deliverables of SPLITMUX and should only be accessible to authorized persons (administrators etc.).

After entering the password on the keyboard or front panel (password is not displayed in password field), the SECURITY window opens.

Enter the desired security level (0 to 8) under "Select security level".

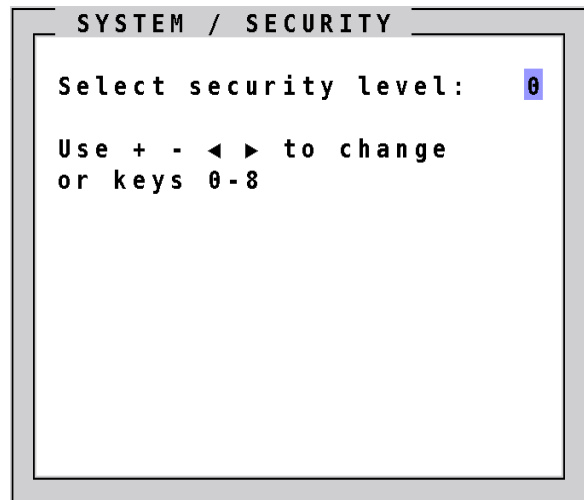

**Note:**

Before changing the security level, please set the configuration you wish to work with to the higher security level, under MODE > START. This configuration will be maintained when SPLITMUX is reset, in case of power failure, or when power is turned off and on again.

**OSD - SYSTEM - SECURITY**

**SECURITY LEVEL 0**

This is the default setting of SPLITMUX. All settings are allowed and all functions are enabled.

**SECURITY LEVEL 8**

Security level 8 allows you to work only on one channel (computer) in a predefined display mode (Quad, Fullscreen or PiP mode). No settings can be changed, apart from the SECURITY menu item, where you can change the security level.

SYSTEM            SECURITY

**SECURITY LEVEL 7**

As security level 8, but you can open OSD windows that only show display modes and device settings.

SYSTEM            HDCP  
 CONSOLE          VIDEO OUTPUT/EDID  
 VIDEO             INPUT STATUS  
 COMPUTER        NAME 1-4/ KEYBOARD / MOUSE / EDID/DDC  
 HELP              HOTKEY / ABOUT / CONTACT

**SECURITY LEVEL 6**

As security level 7, with the following additional operations:

SYSTEM            CONTROL  
 CONSOLE          FADE

- Setting of active channel using front panel buttons, Hotkeys or Hotmouse
- Selecting channel with PiP button in Quad mode
- Changing the directly selectable PiP channel in PiP mode single direct

**SECURITY LEVEL 5**

As security level 6, with the following additional operations:

- Setting of display mode (Quad / Fullscreen / PiP) using front panel buttons, Hotkeys or Hotmouse.

SYSTEM            TEST PATTERN  
 CONSOLE          BACKGROUND

# ON SCREEN DISPLAY

---

## OSD - SYSTEM - SECURITY

### SECURITY LEVEL 4

As security level 5, with the following additional settings in the OSD:

SYSTEM	OSD POSITION / WIN MODE
MODE	PIP / START
CONFIGURATION	RECALL
COMPUTER	AUDIO
VIDEO	FORMAT

- Modify display mode settings in Hotmouse Menu
- Changing both channels in Dual mode
- Changing the fixed PiP channel in PiP mode single fixed

### SECURITY LEVEL 3

As security level 4, with the following additional settings in the OSD:

SYSTEM	OSD LANGUAGE
VIDEO	BRIGHTNESS / CONTRAST / HORIZ POSITION / VERT POSITION
	SCREEN WIDTH / PHASE
USB DEVICE 1-4	

### SECURITY LEVEL 2

As security level 3, with the following additional settings in the OSD:

SYSTEM	HOTKEY / HOTMOUSE / QUAD MODE
CONSOLE	KEYBOARD / Touch screen

### SECURITY LEVEL 1

As security level 2, with the following additional settings in the OSD:

SYSTEM	DISABLE CHANNEL
CONSOLE	MULTIMONITOR / VIDEO OUTPUT
VIDEO	DVI/VGA / ROTATION / CROPPING
COMPUTER	CHANNEL MAPPING / MOUSE / RESET PS/2

- Switch video output to VGA (using hotkey 'V' or front panel buttons 1+2)

**OSD - SYSTEM - DISABLE CHANNEL**

**DISABLE CHANNEL**

Navigate with the arrow keys in the SYSTEM menu to the entry DISABLE CHANNEL

Press ENTER/SELECT to open the DISABLE CHANNEL window.

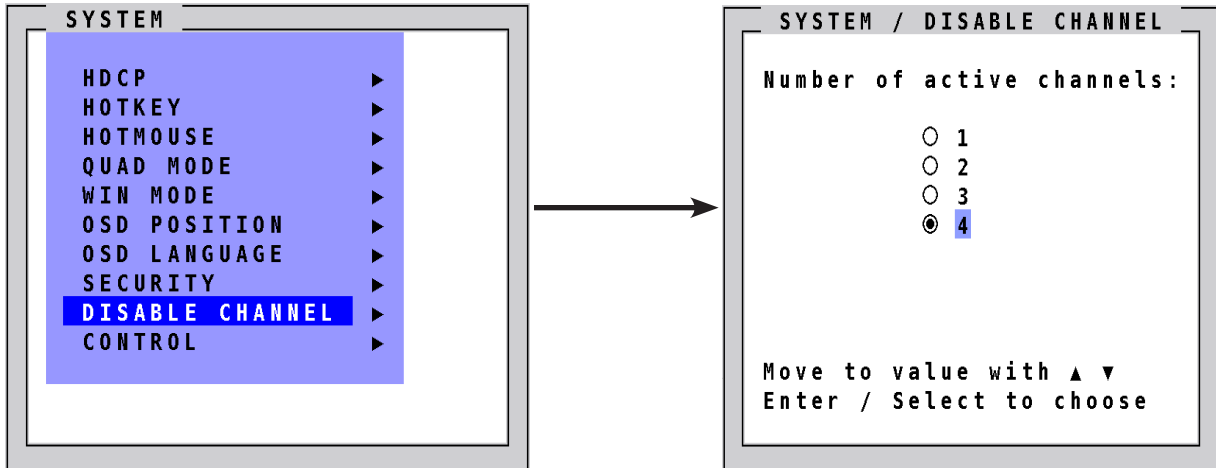

If two or three computers or video sources are connected to SPLITMUX, use the DISABLE CHANNEL feature to ensure that for the unused channels:

- a) message "no signal input x" is not shown in Quad mode
- b) PiP images are not displayed on screen
- c) these channels are not selectable in Fullscreen mode

For example, if you have connected three computers (channel 1 to 3) to SPLITMUX, use the arrow keys to navigate to the number 3 and confirm by pressing ENTER/SELECT.

**Note:** To use the "DISABLE CHANNEL" feature, computers/video sources must be connected to SPLITMUX in ascending order from channel 1 to 4.

Example in Quad mode:

All four channels enabled

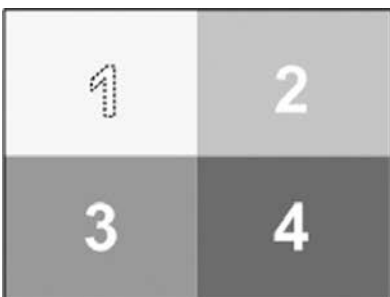

Three channels enabled

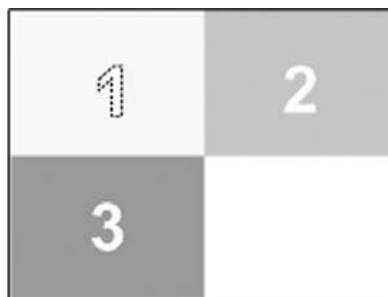

Two channels enabled

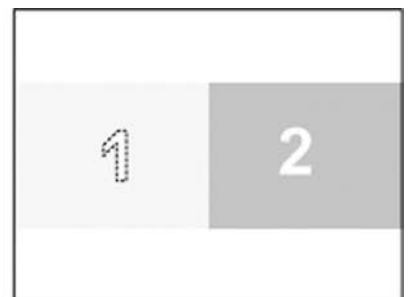

mid-height



# ON SCREEN DISPLAY

## OSD - SYSTEM - CONTROL

### CONTROL

Navigate with the arrow keys in the SYSTEM menu to the entry CONTROL

Press ENTER/SELECT to open the CONTROL window.

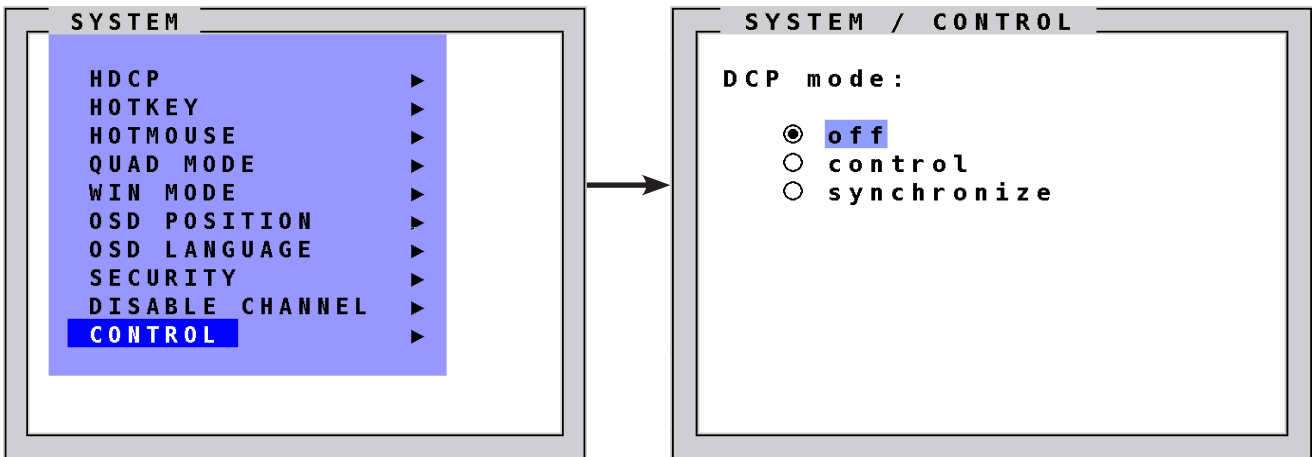

SPLITMUX can be controlled via DCP (Device Control Protocol), an XML-based protocol (see Annex).

There are two DCP modes:

- DCP control**, which allows external control of the display mode.
  - DCP synchronize**, which keeps several SPLITMUX's in the same display mode.
- Default setting is "off", which prevents any external CONTROL.

Use a serial or USB cable to connect a control unit to the RS 232 port (RJ 45) on the SPLITMUX rear panel. To synchronize several devices, special Y cables are required.

Settings for the connection are: Transfer rate 57600 baud, 8 data bits, no parity, 1 stop bit, no flow control

The two control modes operate as follows:

#### DCP control

This mode allows direct control of a single SPLITMUX by means of a control device, e.g. a computer.

The control device can query and change the mode of SPLITMUX.

SPLITMUX responds to each DCP message sent by the control device with a DCP reply. This reply includes the values of all settings queried or set by means of the last message. If the message sent by the control unit contains errors, the SPLITMUX will reply by sending an error message.

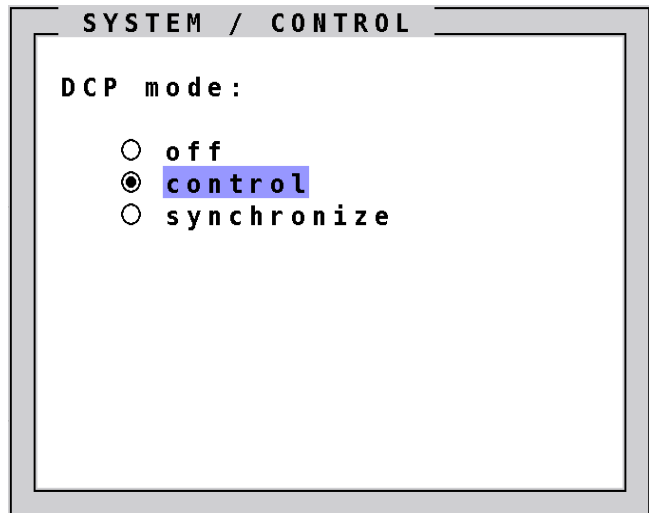

**OSD - SYSTEM - CONTROL**

**Example of DCP control**

A SPLITMUX is controlled via DCP-XML by a computer connected by serial cable or USB.

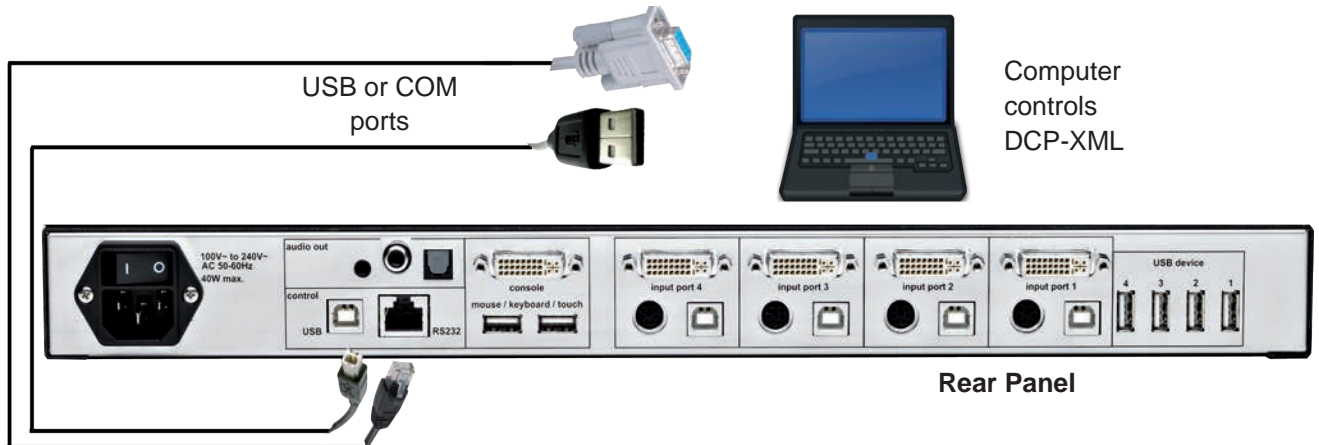

For an introduction to the DEVICE CONTROL PROTOCOL please Annex.

**DCP synchronize**

Use this mode to keep several SPLITMUX devices in the same mode.

Every change in settings initiated in the first SPLITMUX by **hotkeys, hotmouse, front panel buttons or controlling devices** synchronizes the modes of all connected devices via DCP messages.

Use special Y-cables for the synchronization.

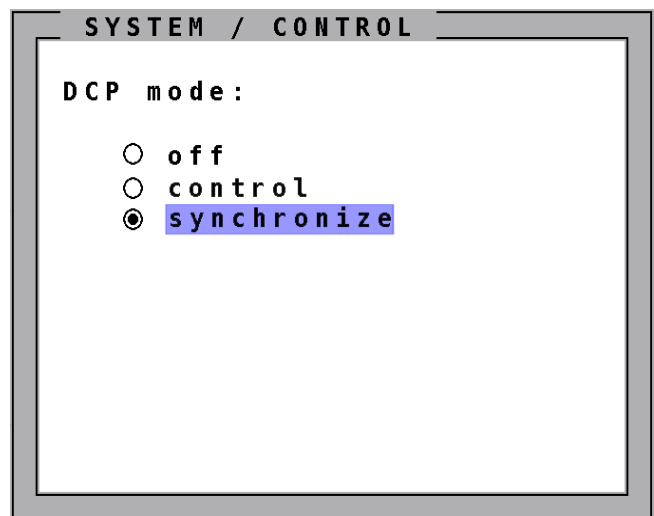

**Important:**

Each time you restart a SPLITMUX set to **synchronize**, it will send all its settings to the next connected device. This process also takes place after activating **synchronize** in the OSD menu.

When starting a chain of devices, always start by **first** switching on the device **at the end of the chain**. When the device has completed its startup phase and sent its DCP messages, switch on the next device in the chain.

Finally, switch on the first device in the chain, which synchronizes the settings of all other devices in the chain with its own settings as it starts up.

# ON SCREEN DISPLAY

## OSD - SYSTEM - CONTROL

### Example of DCP synchronization

SPLITMUX 2 and 3 are synchronized with SPLITMUX 1.

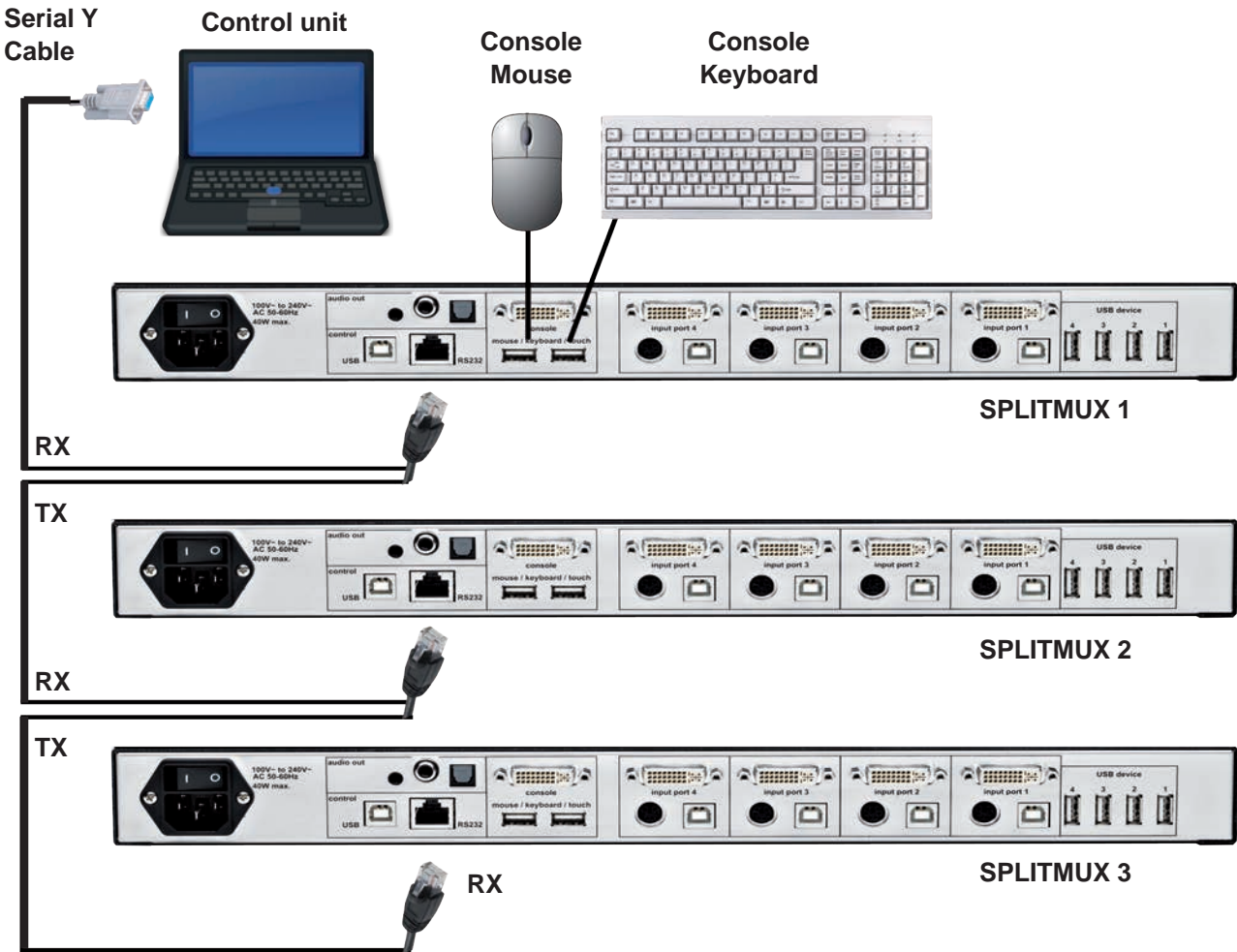

To synchronize, SPLITMUX 1 sends every change in settings as a DCP message via the serial Y to the RX input of SPLITMUX 2.

SPLITMUX 2 adopts the settings and sends a DCP message via TX output over the Y cable to the RX input of SPLITMUX 3.

The synchronization chain can have any length.

Do not connect the last device in the chain to the first device (i.e. do not create a loop).

**OSD - SYSTEM - CONTROL****SECURITY LEVELS**

The security level settings in the OSD menu previously described also apply to control via DCP messages. Queries are possible up to security level 7.

The table below shows the maximum security levels for simple element settings. These settings may be changed via DCP up to the specified protection level.

**Maximum security level for:**

CONSOLE CHANNEL	6
VIDEO CHANNEL	6
VIDEO LAYOUT	5
PIP LAYOUT	4
PIP HEIGHT	4
PIP OFFSET	4
PIP ZOOM	4
PIP CHANNEL	4
DUAL CHANNELS (L/R)	6
PIP SCAN TIME	4

# ON SCREEN DISPLAY

## OSD - MODE - CURRENT/START

### CURRENT

Defines the current mode in which the device should run.

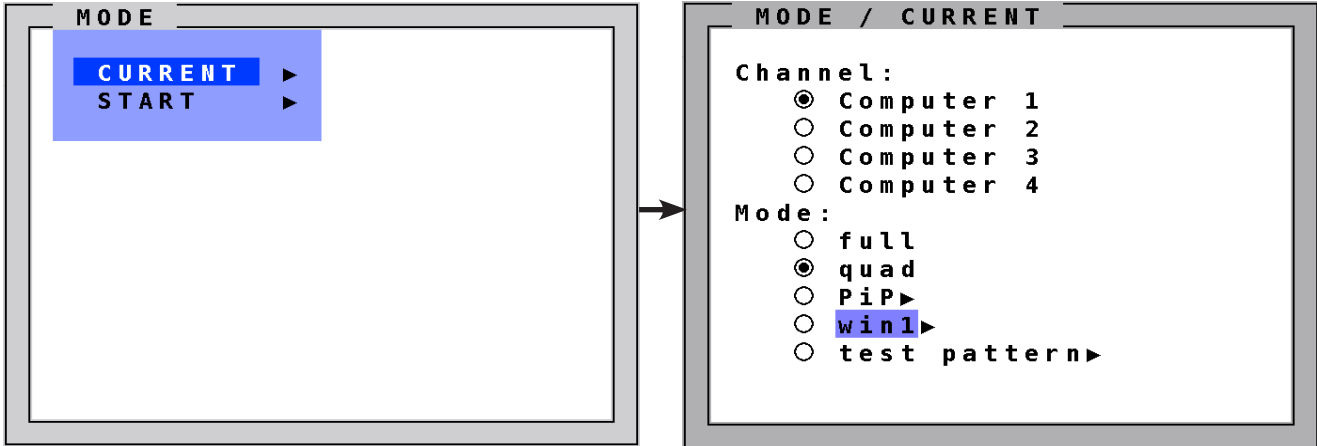

Choose from Fullscreen, Quad Mode, PiP, Win Mode or Test Pattern.

### START

Sets the mode in which the device should boot.

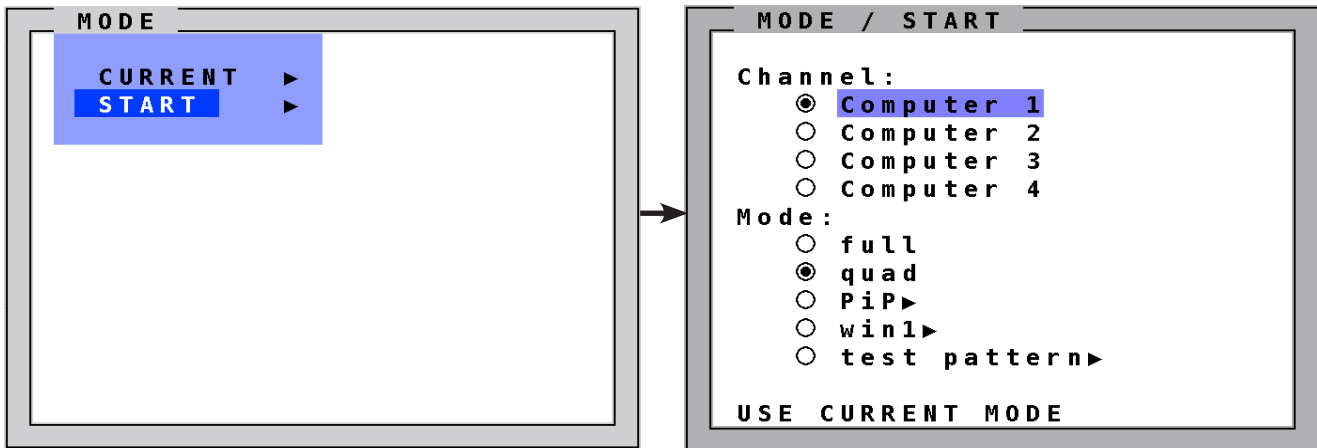

This feature allows you to define the start configuration, i.e. the display mode (Fullscreen, Quad, PiP, Win or Test Pattern), active channel, and PiP settings which SPLITMUX uses after a reset or when the system is powered up.

When the **START** menu is called up, the current start configuration is displayed. To modify your start configuration, change parameters in the channel, mode, and PiP fields. Press **ESC** to save the new parameters and exit the **START** menu.

Choose "Use current mode" to adopt the current settings as start mode. Use arrow keys to navigate to "Use current mode" and confirm by pressing **ENTER**.

The factory default start mode is Quad-mode with active channel 1.

See **OSD - MODE - CURRENT/START - PiP** for details on setting PiP mode to boot. See **OSD - MODE - CURRENT/START - WIN** for details on setting Win mode to boot. See **OSD - MODE - CURRENT/START - TEST PATTERN** for details on setting a test pattern to boot.

**OSD - MODE - CURRENT/START - PiP**

**PiP**

Use this section to define the current mode in which the device should run.

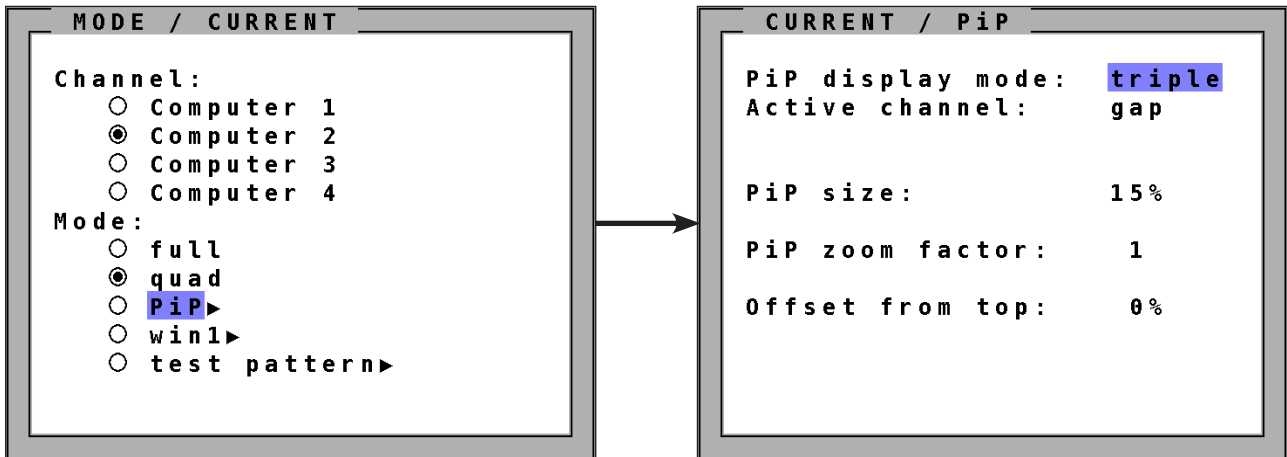

In the PiP window you can configure PiP size, position, and display mode.

**PiP Display Mode**

Select the option TRIPLE to show 3 additional screens in PiP Mode. Select SINGLE to display only one other screen. If SINGLE is selected. Use the option PiP CHANNEL to define which channel should appear in the single window.

See the section Display Modes for details.

**PiP size**

Adjust the size of PiP images to your requirements. 12 (single mode) or 9 (triple mode) different sizes are available:

Single: 3 % - 5 % - 7 % - 10 % - 15 % - 20 % - 25 % - 28 % - 33 % - 38 % - 44 % - 50 %

Triple: 3 % - 5 % - 7 % - 10 % - 15 % - 20 % - 25 % - 28 % - 33 %

50 % equals the size of one quad screen (one quarter of a full size screen).

**Note:** All settings also possible via Hotmouse Menu, see page 46.

### OSD - MODE - CURRENT/START - PiP (continued)

#### **PIP zoom factor**

Use this option to zoom the center of the PiP images by a factor of 2.

#### **Offset from top**

Use this option to change the position of PiP images. PiP images can be moved vertically to any position on the screen's right hand margin.

#### **Note:**

All settings also possible via Hotmouse Menu, see page 46.

**OSD - MODE - CURRENT/START - PiP**

**PIP Display Modes**

SPLITMUX offers the following PiP modes:

PIP display mode **triple**: All other video sources are displayed (three PiP images)

```

MODE / PiP
PiP display mode: triple
Active channel: gap

PiP size: 25%
PiP zoom factor: 1
Offset from top: 0%
    
```

**Triple gap:**  
PiP images are displayed with a gap in place of the active channel.

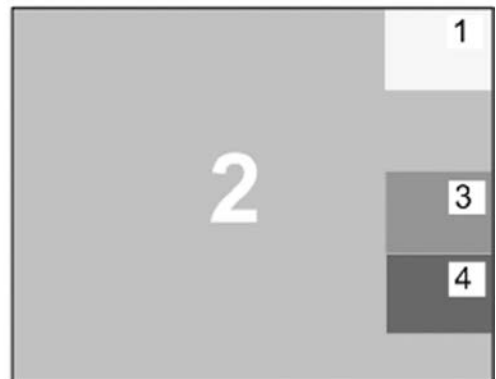

```

MODE / PiP
PiP display mode: triple
Active channel: no gap

PiP size: 25%
PiP zoom factor: 1
Offset from top: 0%
    
```

**Triple no gap:**  
PiP images are displayed without a gap.

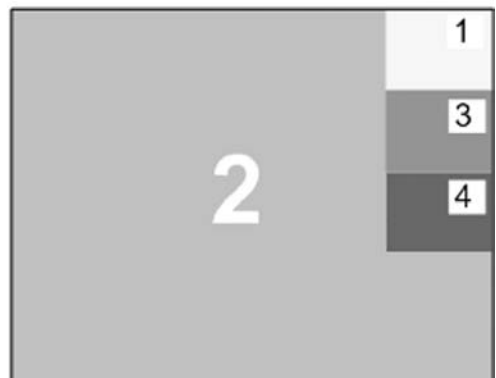

```

MODE / PiP
PiP display mode: triple
Active channel: tile

PiP size: -
PiP zoom factor: 1
Offset from top: -
    
```

**Triple tile:**  
The size of the main image and the PiP images is optimized so that the main image and the PiP images are shown as large as possible without overlapping.

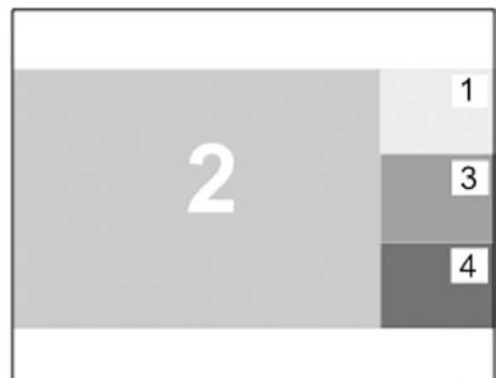



**OSD - MODE - CURRENT/START - PiP**

**PIP Display Modes (continued)**

PIP display mode **single**:

One PiP image is displayed. You can choose between different display modes:

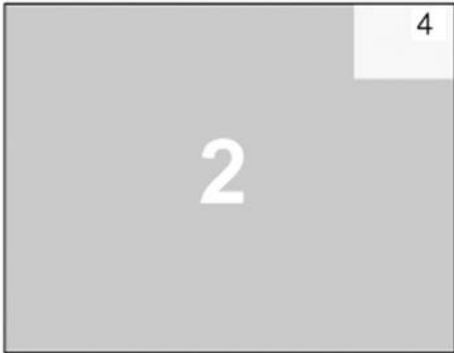

```

MODE / PiP
PiP display mode:  single
Channel selection:  fixed
PiP channel:      4

PiP size:         15%
PiP zoom factor:  1
Offset from top:  0%
    
```

**Single fixed:**

One channel is selected to be displayed as permanent PiP image. Only the active channel (full image) can be switched. Press front panel buttons 1, 2, 3, or 4 to switch the full image.

```

MODE / PiP
PiP display mode:  single
Channel selection:  direct
PiP channel:      4

PiP size:         15%
PiP zoom factor:  1
Offset from top:  0%
    
```

**Single direct:**

One channel is selected to be displayed as permanent full image (active channel).

Only the PiP can be switched. Press front panel buttons 1, 2, 3, or 4 to switch the full image.

```

MODE / PiP
PiP display mode:  single
Channel selection:  scan
Scan time:        5 sec

PiP size:         15%
PiP zoom factor:  1
Offset from top:  0%
    
```

**Single scan:**

Within a PiP image, the three other video sources are displayed one after the other; the delay can be set to between one and nine seconds.

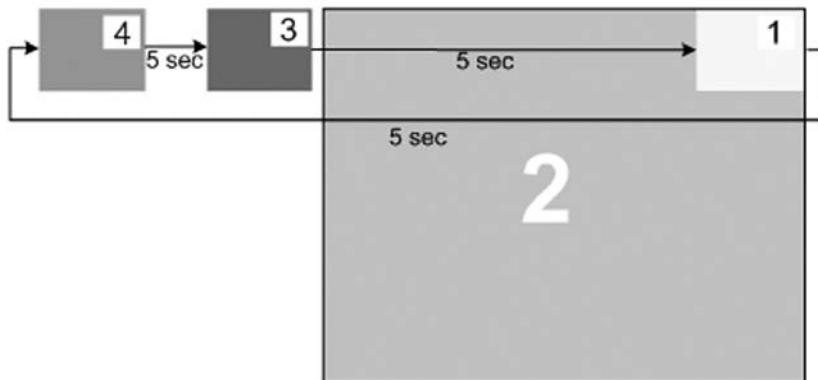

## WIN MODE

Navigate with the arrow keys in the MODE menu to the entry WIN

Press ENTER/SELECT to open the WIN MODE window.

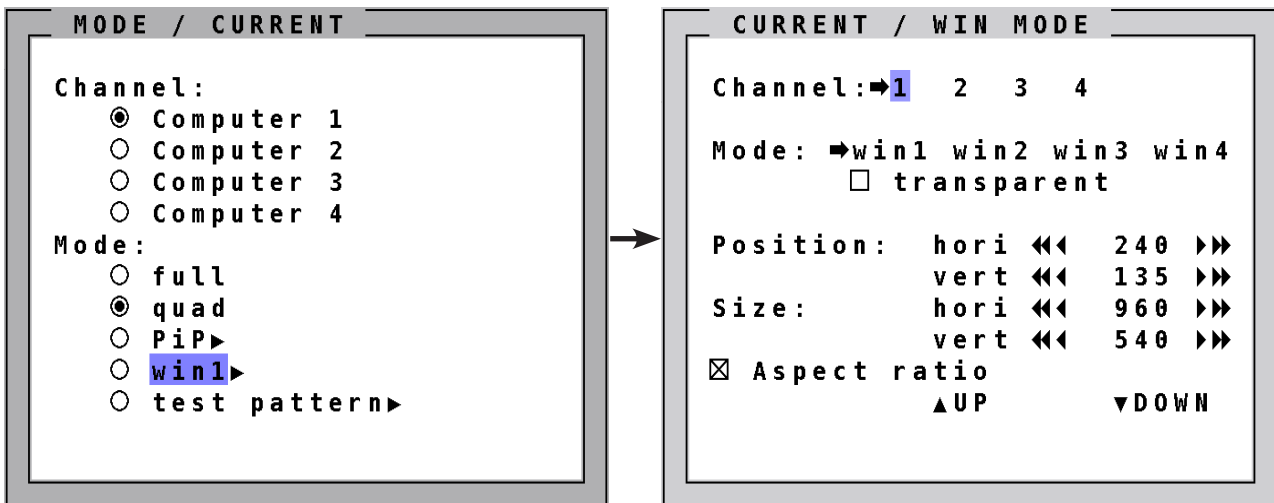

Select the channel, window mode, position and window size in the window WIN MODE.

The arrows can be used to select the horizontal or vertical position or size of the windows.

Activate the checkbox ASPECT RATIO to retain the aspect of the video source.

Changes made in the WIN MODE window are automatically saved by the SPLITMUX as you make them.

**Presets are WIN MODE configurations displaying the video from each channel in a specifically configured position, size and aspect ratio. Up to 4 different Presets can be saved in the SPLITMUX.**

**The WIN MODE window is used to not only configure the Presets (Win1, Win2, Win3 and Win4) but also to choose a Preset to display. Simply select the desired Preset and press <Enter>.**

**Presets can be enabled:**

1. Using the OSD menu (above)
2. Using the HOTMOUSE menu (page 82)
3. Using the SPLITMUX front panel (press WIN and button 1-4)
4. Using HOTKEY (HOTKEY + W puts you in Win Mode, then HOTKEY + W + x (x=Preset number) changes the Preset being viewed.)
5. Using DCP-XML Remote Control program.

# ON SCREEN DISPLAY

## OSD - MODE - CURRENT/START - TEST PATTERN

### TEST PATTERN

Navigate with the arrow keys in the MODE menu to the entry TEST PATTERN

Press ENTER/SELECT to open the TEST PATTERN window.

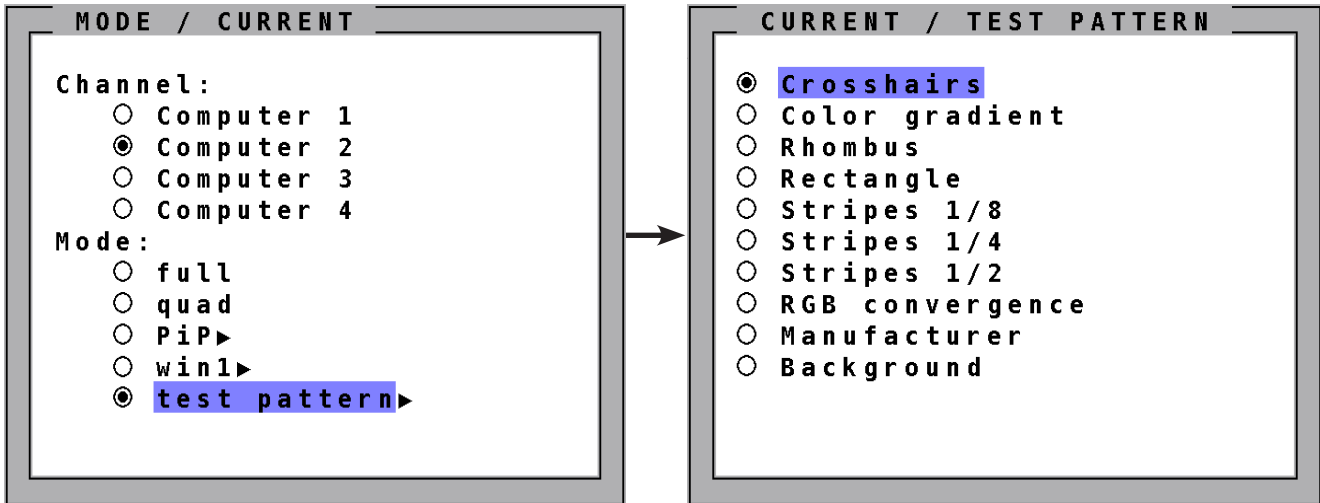

Use the Test Pattern feature to check monitor quality (pixel errors, contrast, changes etc) or the functionality of the video output of the SPLITMUX.

It is recommended to use all available test patterns for the test procedure.

To exit TEST PATTERN mode, use the OSD, the front panel buttons (Full, Quad, PiP or Win) or hotkey commands accordingly.

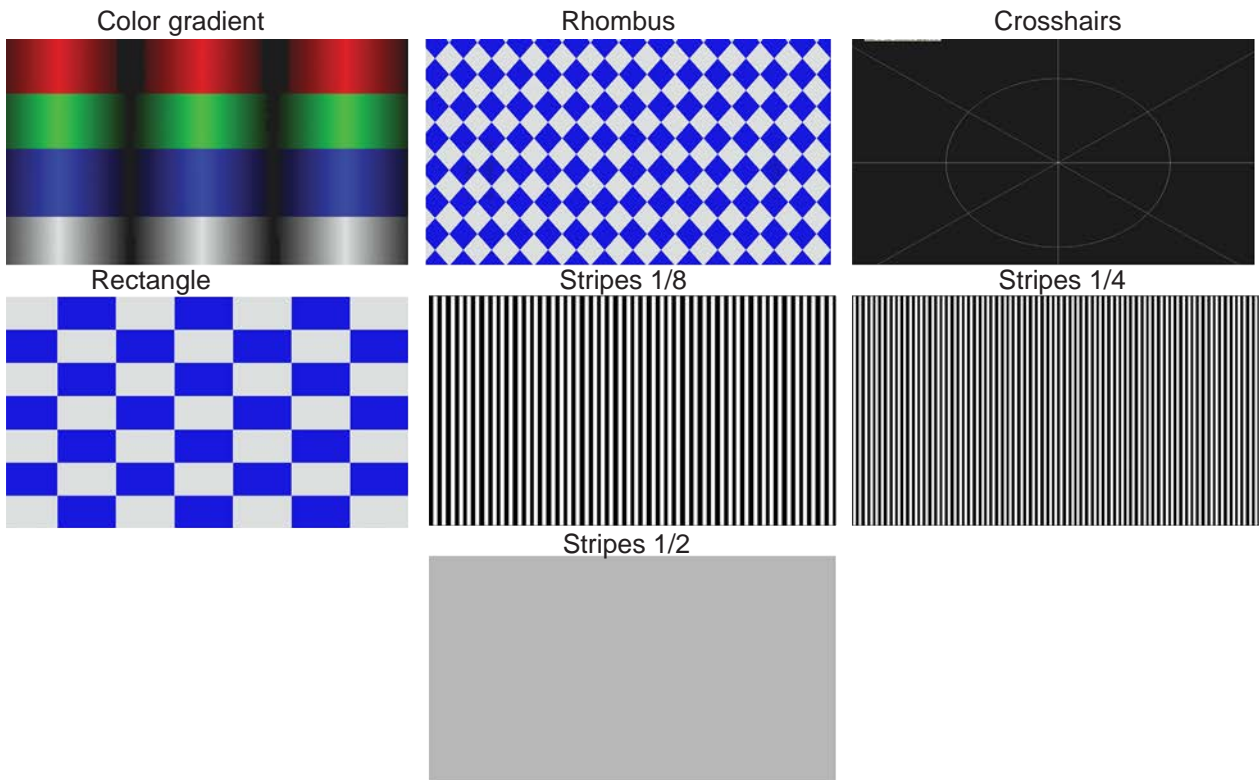

**OSD - CONFIGURATION - BACKUP / RECALL**

**BACKUP**

Navigate with the arrow keys in the CONFIGURATION menu to the entry BACKUP

Press ENTER/SELECT to open the BACKUP window.

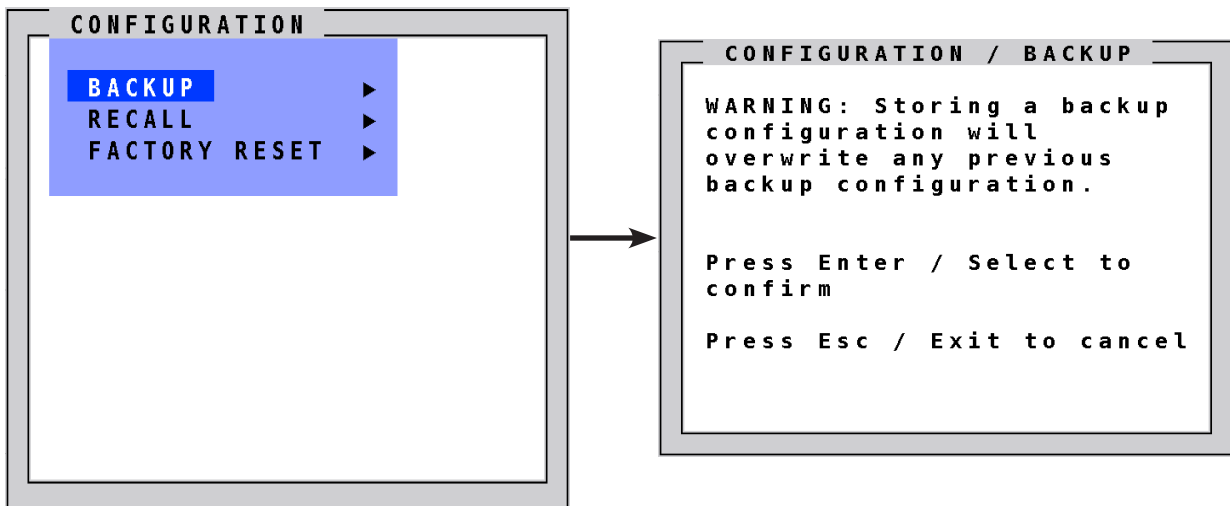

This function saves the current device settings, including the start mode set in MODE START. Additionally, EDID data from the 4 inputs is also saved.

For details on creating an external backup to a file, see the section "Device Configuration Program".

**RECALL**

CONFIGURATION menu to the entry RECALL

Press ENTER/SELECT to open the RECALL window.

Use this feature to replace the current settings with the last configuration saved using the BACKUP command.

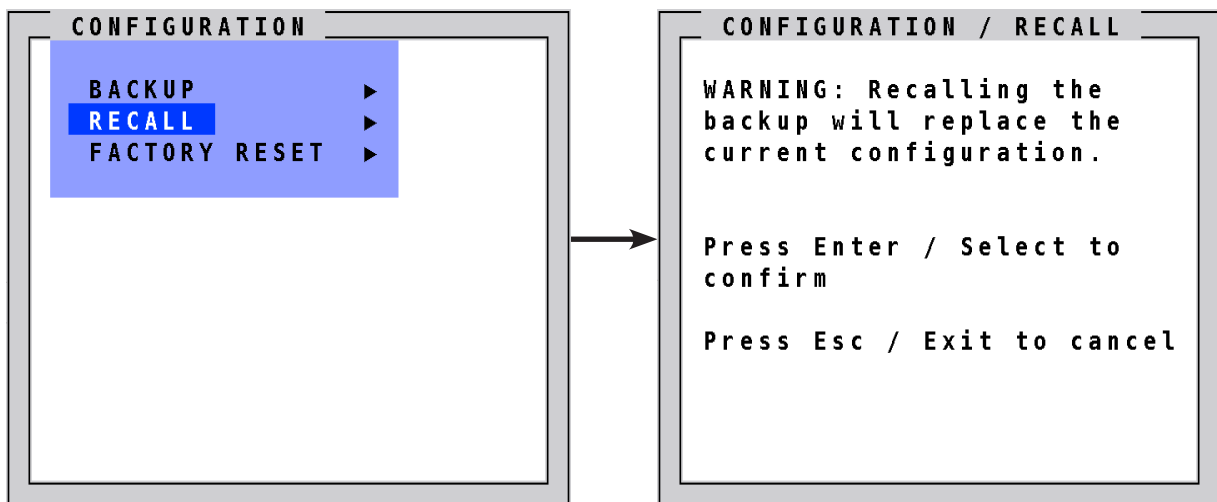

# ON SCREEN DISPLAY

## OSD - CONFIGURATION - FACTORY RESET

### FACTORY RESET

Navigate with the arrow keys in the CONFIGURATION menu to the Factory Reset  
Press ENTER/SELECT to open the DEFAULTS window.

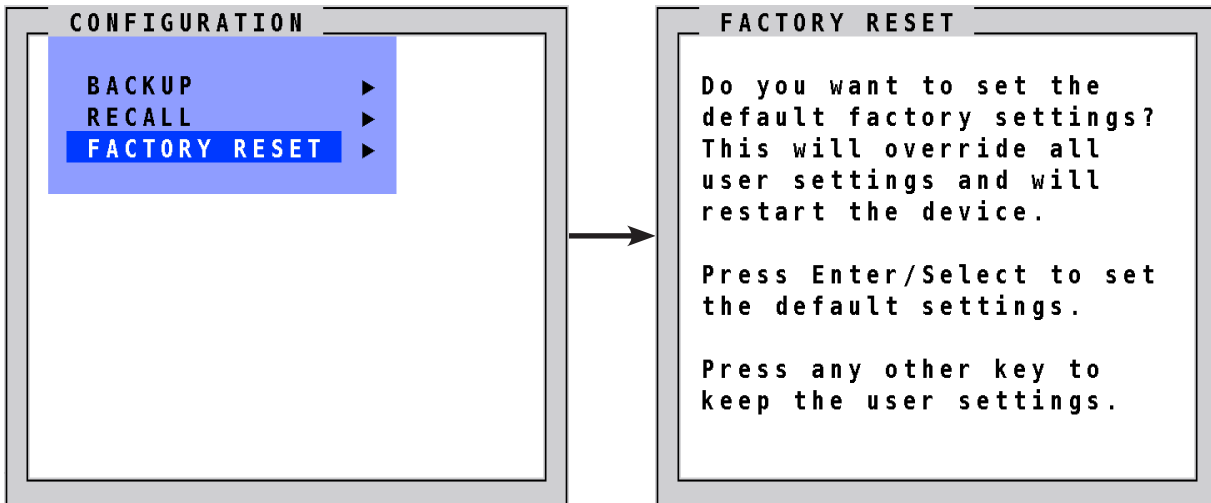

Use this function to reset the current settings of SPLITMUX to the factory default configuration. All four input EDIDs are also reseted to their default values.

If necessary, save your current settings before using the DEFAULTS command. Execution of this command results in a complete reset and reboot of SPLITMUX with factory defaults.

### FACTORY DEFAULTS:

#### SYSTEM

- HOTKEY = Multiple Hotkey / Hotkey = Ctrl + Alt
- HOTMOUSE = ON / Hotmouse timeout = 5 sec.
- QUAD MODE = Channel selection timeout = 5 sec.
- WIN MODE = Border width = 0 sec.  
Active channel= 255,255,0  
Active channel= 255,136,0
- OSD POSITION = centered
- OSD LANGUAGE = English
- SECURITY = None (security level = 0)
- DISABLE CHANNEL = All four channels are active
- CONTROL = Off

#### MODE

- CURRENT = Active channel = 1, quad
- START = Active channel = 1, quad
- > PIP Size = 15 % Zoom factor = 1  
Display mode = triple Active channel = gap;  
Offset from top = 0 %
- >WIN = Channel: 1, Mode:win1, Position settings depend on the source, Aspect ratio: enabled

**OSD - CONFIGURATION - FACTORY RESET**

**FACTORY DEFAULTS (continued):**

<b>CONSOLE</b>	VIDEO OUTPUT	= auto
	KEYBOARD	= English
	TOUCH SCREEN	= Mouse emulate right click /
	FADE	= Off
	MULTI MONITOR	= Monitor 1 --> Channel 1; Monitor 2 --> Channel2; Monitor 3 --> Channel 3; Monitor 4 --> Channel4;
	BACKGROUND	= Color / 0,0,0
<b>VIDEO</b>	DVI/VGA	= DVI / VGA (all channels)
	ROTATION	= 0
	CROPPING	= no cropping
	BRIGHTNESS	= +0 (all channels)
	CONTRAST	= 56 % (all channels)
	HORIZ POSITION	= auto (all channels)
	VERT POSITION	= auto (all channels)
	SCREEN WIDTH	= +0 (screen-width correction of all channels)
	PHASE	= +0 (all channels)
FORMAT	Fit to screen = No (all channels)	
<b>COMPUTER</b>	CHANNEL MAPPING	= Positioning = relative (all channels)
	AUDIO	= Enable audio output / Select active channel / Switch channel on audio activity = off
	NAME 1-4	= Computer 1-4 respectively
	KEYBOARD	= USB
	MOUSE	= positioning realtive
	RESET PS/2"	= Channel 1 selected
	EDID / DDC	1600x1200@60, 1920x1200@60, digital
<b>USB DEVICE 1-4</b>		= Off / manual switching w. warning / name: Device 1 (-4)

# ON SCREEN DISPLAY

## OSD - CONSOLE - VIDEO OUTPUT

### VIDEO OUTPUT

Navigate with the arrow keys in the CONSOLE menu to the entry VIDEO OUTPUT

Press ENTER/SELECT to open the VIDEO OUTPUT window.

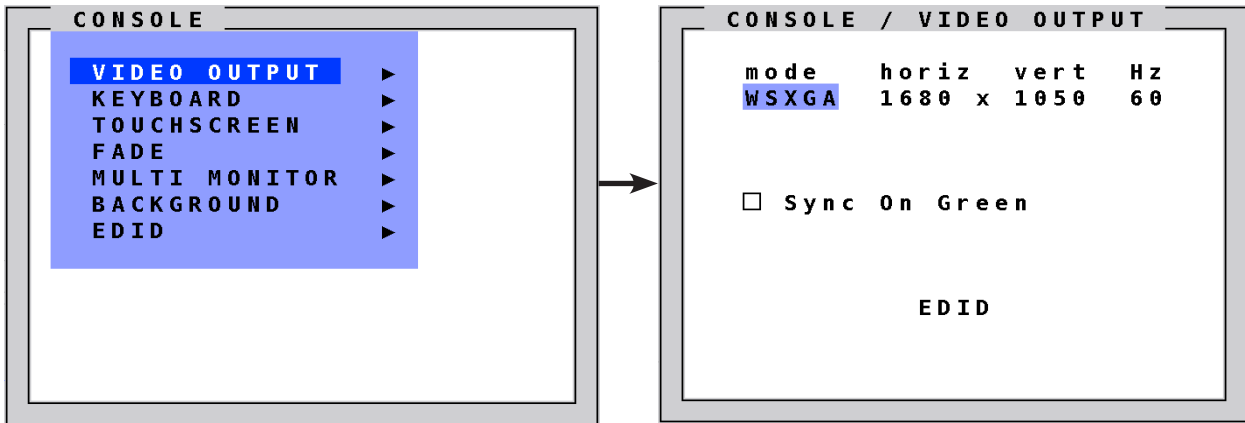

Use the VIDEO OUTPUT menu to choose an output resolution supported by your monitor.

Press ENTER/SELECT to enter the selection menu.

Use arrow keys to select the desired line in the list shown on the right and press ENTER/SELECT for the new video format.

The new output mode is visible for 10 seconds.

Within this time you can either accept the new setting by pressing ENTER/SELECT or return to your original setting by pressing ESC/EXIT.

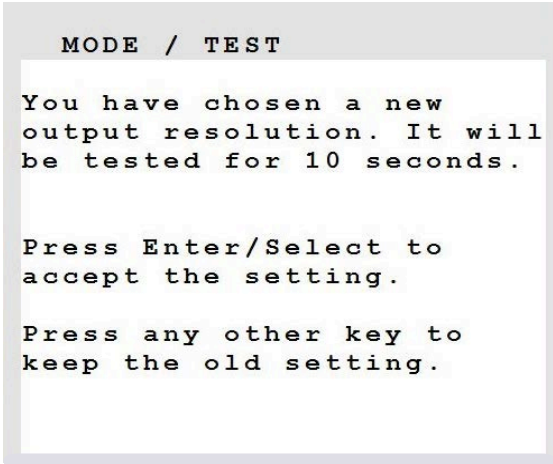

When the output mode is set to 'auto', SPLITMUX chooses a resolution by reading the connected monitor's EDID data. Choose the EDID menu item to check whether the connected monitor provides this data.

If the monitor does not offer this data, SPLITMUX sets VGA mode (640x480@60Hz) as default and activates Sync on Green.

Sync on Green can be deactivated on SPLITMUX.

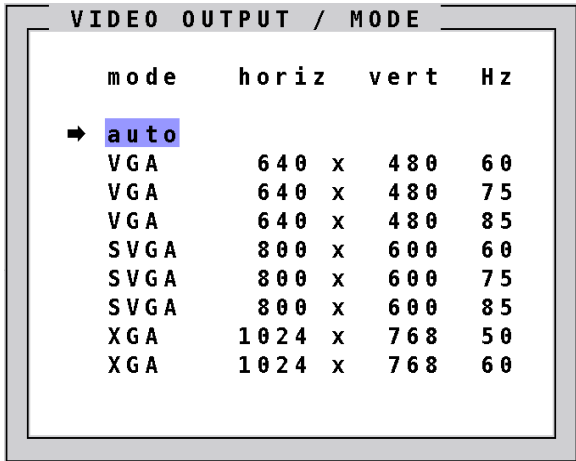

**OSD - CONSOLE - KEYBOARD****KEYBOARD**

Navigate with the arrow keys in the CONSOLE menu to the entry KEYBOARD

Press ENTER/SELECT to open the KEYBOARD window.

Set the keyboard layout to the desired language, English, Deutsch (German), Español (Spanish), Français (French), Italiano (Italian) or Japanese.

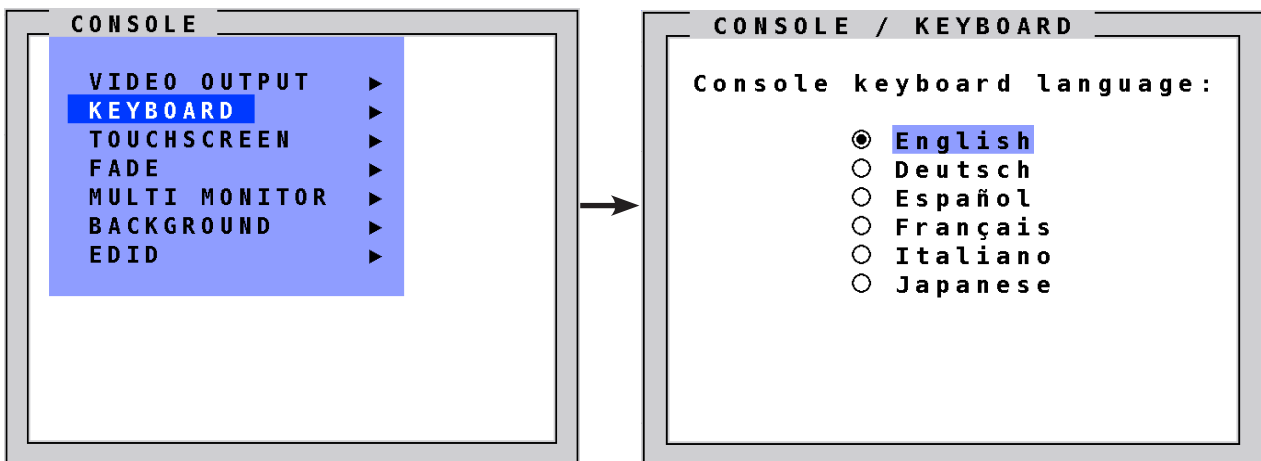



# ON SCREEN DISPLAY

## OSD - CONSOLE - TOUCH SCREEN

### TOUCH SCREEN

SPLITMUX enables the user to use a touch screen to control and switch between four computers as well as change display modes.

SPLITMUX supports a great number of USB touch screens with commonly integrated touch controllers. For a list of supported touch screens, please see Annex on page 97.

To control SPLITMUX using a touch screen, connect the touch screen to SPLITMUX by connecting the VGA or DVI cable from the SPLITMUX monitor port to the input of the touch screen. Connect the USB port of the touch screen to the SPLITMUX console USB port. Please see page 9 for a description of the SPLITMUX ports.

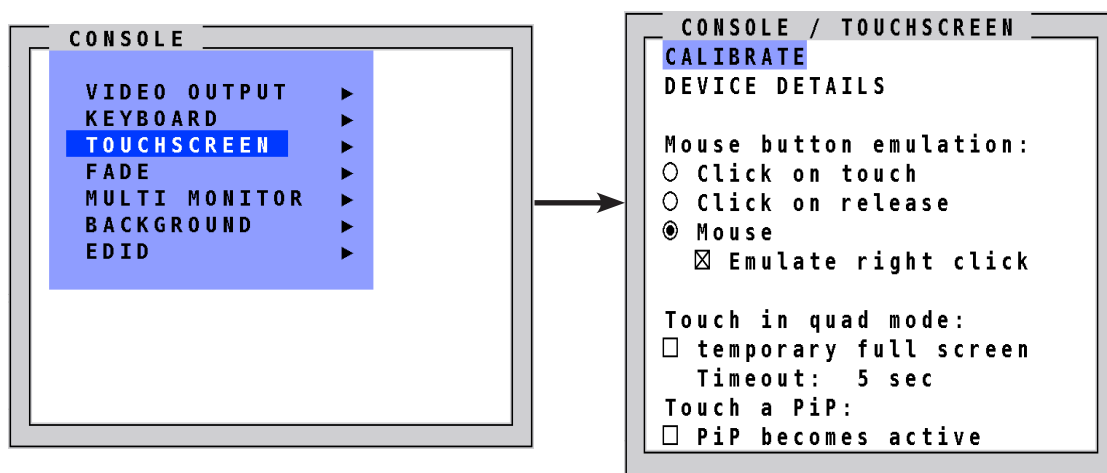

### Calibration

After connecting a touch screen to SPLITMUX for the first time, calibrate the touch screen.

Open CONSOLE ► TOUCH SCREEN menu, choose CALIBRATE, and press ENTER/SELECT.

Four markers will be displayed in the corners of the touch screen.

The diagram shows the first marker in the top left corner of the screen.

Touching the center of the markers as accurately as possible yields best calibration results.

Then repeat for the other three markers to complete calibration.

### Device Details

Select this option to display touch screen information such as the manufacturer ID and product ID.



## OSD - CONSOLE - TOUCH SCREEN

### Mouse button emulation

SPLITMUX offers three modes of interpreting the user input as mouse clicks.

1. Mouse: When touching the touch screen, the mouse button is pressed.  
When the finger is released from the touch screen, the mouse button is released.  
This mode can be used for drag and drop operations.
2. Click on touch: When touching the touch screen, a mouse click is generated at the position of the touch.
3. Click on release: When the finger is released from the touch screen, a mouse click is generated at the last position of the finger.

By default, "mouse" is set as mode. You could use your finger on the touch screen similarly to using your mouse. "Click on touch" and "click on release" are suited for kiosk applications or environments where touch screens are used instead of keyboards and mice, such as in medical industries for hygienic reasons, in industrial production and automation for operation with gloves, or in vehicles and aircraft where robust components are required.

### Touch in quad mode:

Check this box to switch a quadrant from Quad mode temporarily to full screen when touching the quadrant. This activates keyboard and mouse of that quadrant and allows operating the computer in full screen. The other sources are not visible during this time. After a timeout of 5 seconds without keyboard/mouse activity, SPLITMUX automatically switches back to Quad mode. The timeout can be set to values between 1 and 10 seconds.

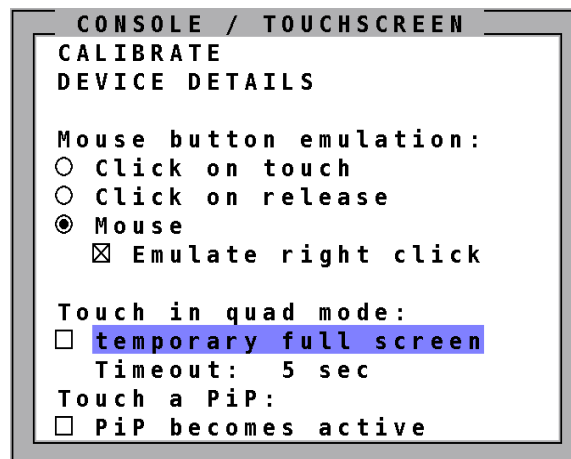

### Touch a PiP:

Check this box to activate keyboard and mouse on a computer shown as PiP. When touching a PiP, keyboard and mouse become active in this PiP. This activated channel now remains a little PiP and does not switch to full image. In this PiP you can operate the computer with keyboard and mouse.

When unchecked (by default), a PiP is switched to full image as soon as it is touched. The full image gets exchanged with the other sources remaining visible as PiPs.

### OSD - CONSOLE - TOUCH SCREEN

#### Right mouse button

Press and hold your finger on the touch screen to emulate the right mouse button. This only works in "mouse" emulation mode, not in "click on touch" or "click on release". By default „Emulate right click" is set in order to perform a right mouse click. Some touch controller models do not support right mouse click. Using touch screens with such controllers requires unchecking the box "Emulate right click".

#### Hotmouse and Hotmouse Menu

To open the Hotmouse Menu, tap the screen twice, and leave your finger pressed on the touch screen after the second tap (tap – hold, like a double click without lifting the finger on the second click), until the Hotmouse Menu opens.

By clicking outside the Hotmouse Menu, you can open the Hotmouse Cursor to enlarge and reposition PiPs (only in PiP mode), resize and move windows in Win mode, and switch channels (see description of the Hotmouse function).

After you are finished using the Hotmouse Cursor, the Hotmouse Menu will reopen.

#### Mouse position

##### Absolute mouse position

SPLITMUX works best together with touch screens when using absolute mouse positioning mode with the connected computers. To enable absolute mouse positioning mode, use the menu COMPUTER ► MOUSE in the OSD.

This mode works when a computer is connected via USB, and with most modern operating systems.

##### Relative mouse position

When using relative mouse positioning, please check the configuration of the computers connected to ensure that mouse acceleration is switched off and mouse scaling is set to 1:1.

Resetting the mouse position: When using relative positioning mode, the actual position of the mouse cursor and the position of your finger on the touch screen may not match in certain cases when a computer switches resolution or changes the mouse position (e.g. when the system is configured to place the mouse pointer over the 'OK' button of a window). In these cases, to reset the mouse position, either switch to a different channel, and back again, or tap the touch screen three times, and leave your finger pressed on the touch screen after the third tap (tap – tap – hold), until the mouse cursor moves to the top left corner of the screen.

**OSD - CONSOLE - MOUSE****MOUSE**

Use arrow keys to navigate in the CONSOLE menu to the entry MOUSE and press ENTER/SELECT to open the MOUSE window.

If you wish to be able to quickly switch between multiple screens in a split-screen environment controlling each using one monitor and one set of keyboard and mouse, apply a checkmark in the box "Enable cross channel switching"

With this enabled, simply move the mouse across the split screen to each device and operate it. Then you can move between the screens and just activate it with a simple left mouse click.

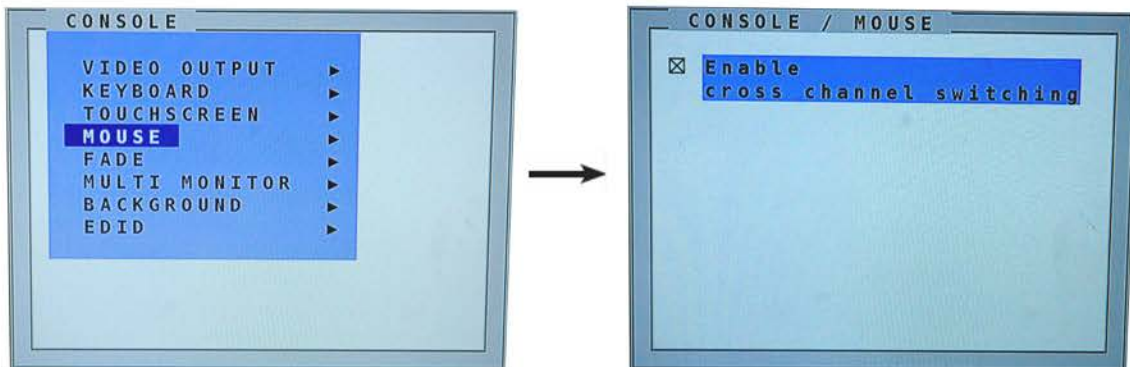
**OSD - CONSOLE - FADE****FADE**

Use arrow keys to navigate in the CONSOLE menu to the entry FADE and press ENTER/SELECT to open the FADE window.

Fade Through Black is an elegant visual effect for presentations: When switching channels or display modes, the previous image fades to black, and the next image is faded in smoothly.

To enable fade through black, select the transition speed under "Smooth transitions". The "Speed" setting controls the speed of the transition, with 1 being the slowest, and 3 the fastest transition.

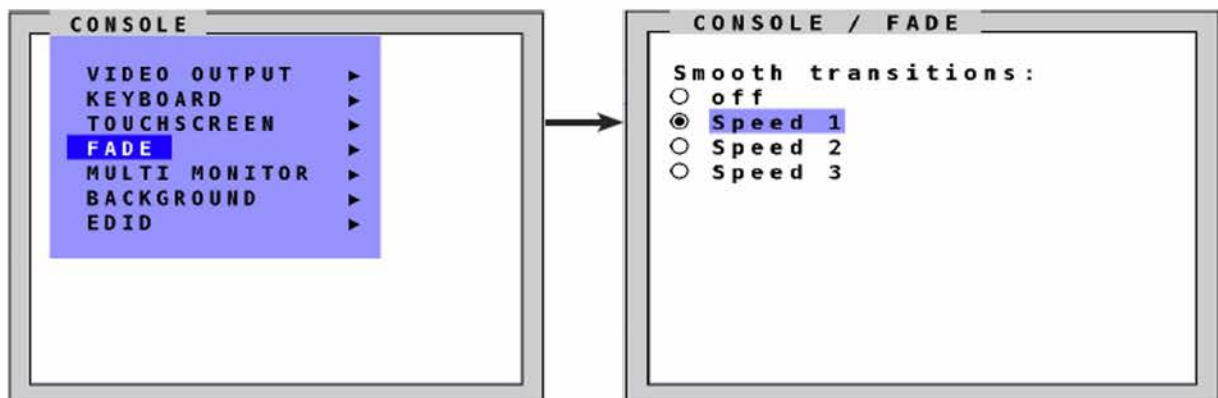

# ON SCREEN DISPLAY

## OSD - CONSOLE - MULTI MONITOR

### MULTI MONITOR

Use arrow keys to navigate in the CONSOLE menu to the entry MULTI MONITOR and press ENTER/SELECT to open the MULTI MONITOR window.

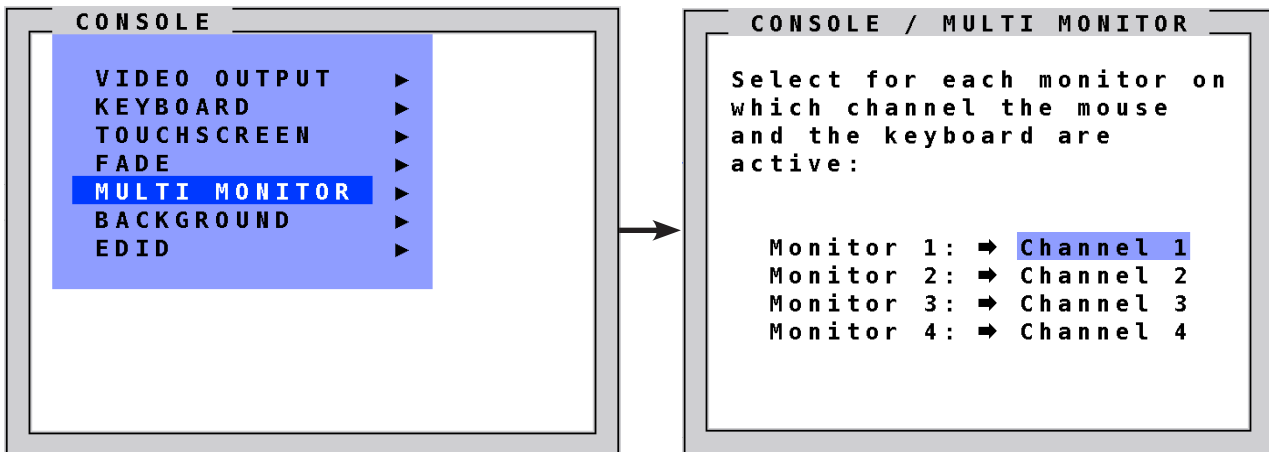

Multi Monitor is used if computers with multiple video output are connected to SPLITMUX but only one keyboard and mouse to operate the computer. If you use graphics cards with multiple video outputs, you must assign the computer's mouse and keyboard to the corresponding video output (channels 1-4).

Example:

If a computer with quad-head graphics card is connected to SPLITMUX, and keyboard and mouse are connected to channel 1, you must assign console „channel 1” to all video channels („Monitor 1 - 4”).

**OSD - CONSOLE - BACKGROUND**

**BACKGROUND**

Use arrow keys to navigate in the CONSOLE menu to the entry BACKGROUND and press ENTER/SELECT to open the BACKGROUND window.

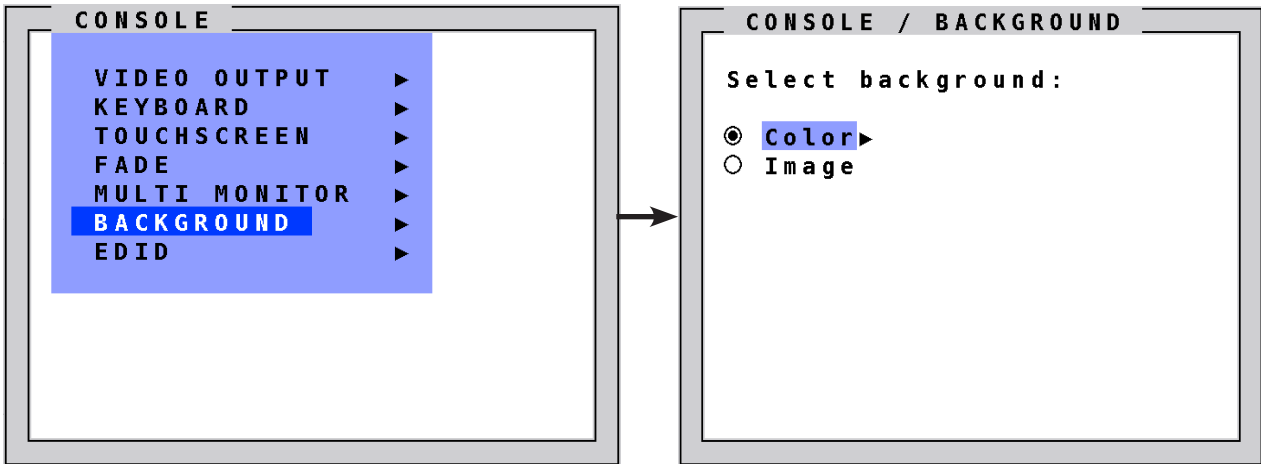

Use the window BACKGROUND to select either a solid color or an image for the background area of the screen on which windows are displayed. Note: The background is shown only in Win mode. Default color for the other modes is black.

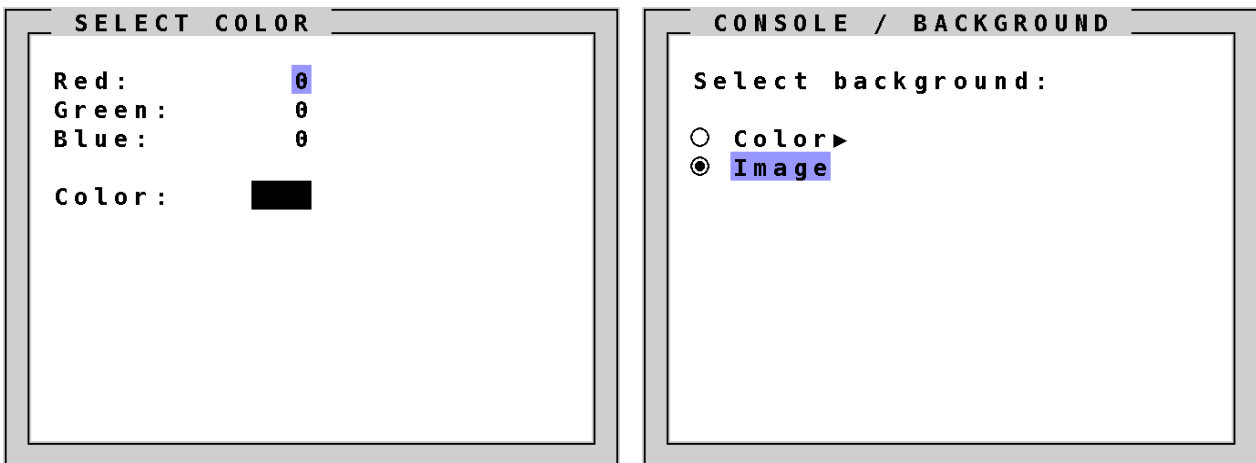

Use BACKGROUND > COLOR to set the color of the background. Enter the desired color in 24 bit color red, green and blue values. A preview of the color will appear in the field COLOR.

After selecting BACKGROUND > IMAGE, the background area of the screen will be filled with the image that has been previously selected in the utility ConfDev under *DEVICE > LOAD BACKGROUND IMAGE*. If no image has been loaded, this option will not appear.

# ON SCREEN DISPLAY

## OSD - CONSOLE - EDID

EDID (display of monitor data)

Use arrow keys to navigate in the CONSOLE menu to the entry EDID and press ENTER/SELECT to open the EDID window.

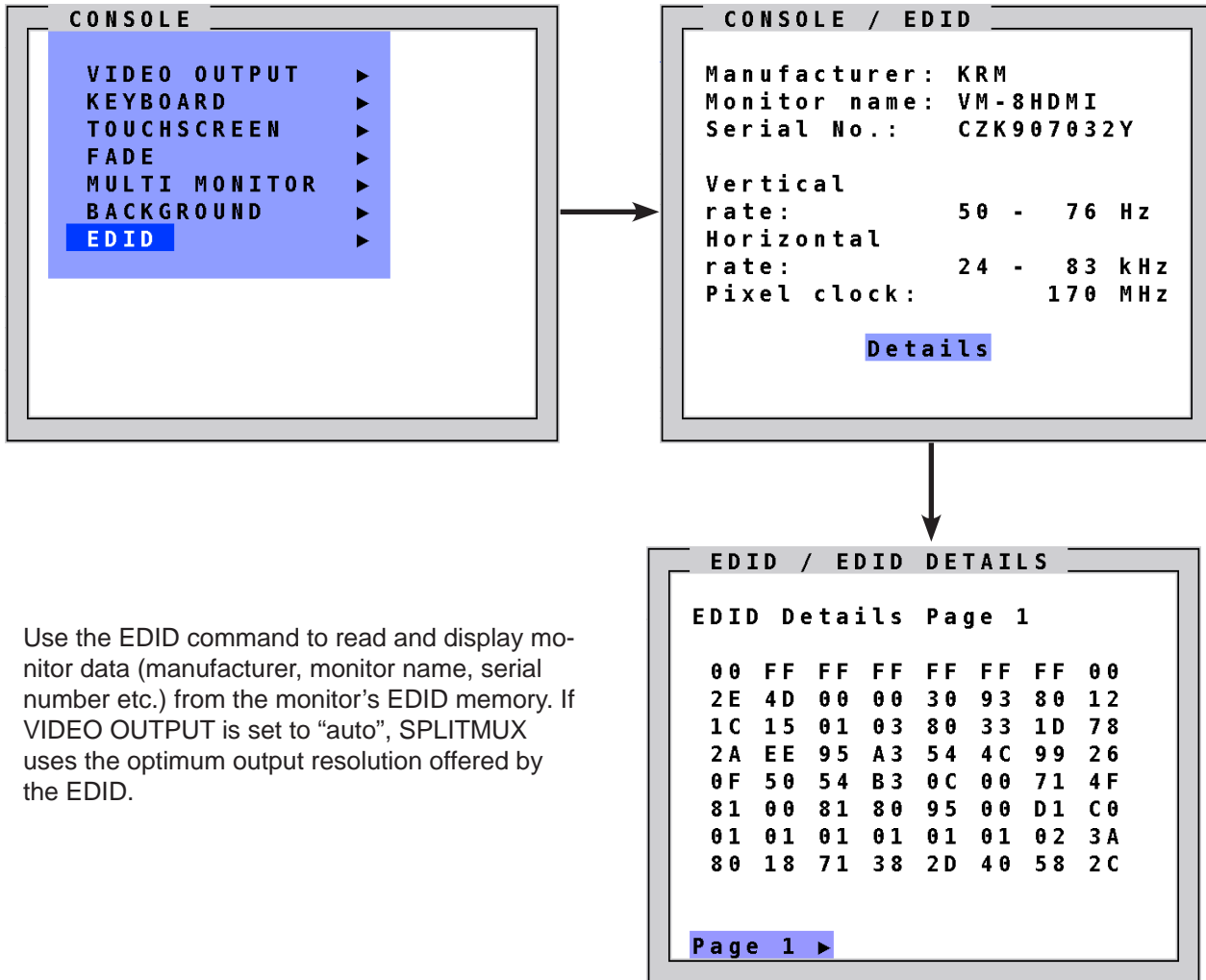

Use the EDID command to read and display monitor data (manufacturer, monitor name, serial number etc.) from the monitor's EDID memory. If VIDEO OUTPUT is set to "auto", SPLITMUX uses the optimum output resolution offered by the EDID.

**EDID (Extended Display Identification Data)** is a VESA standard data format that contains basic information about a monitor and its capabilities. This information is stored in the monitor by the manufacturer and can be read by SPLITMUX or graphics card via a monitor cable's Display Data Channel (DCC) interface.

**Note:**

EDID information can be copied to the four inputs and are then available for the connected sources. See COMPUTER > EDID/DDC.

**OSD - VIDEO - INPUT STATUS****INPUT STATUS (Display Video Formats)**

Use arrow keys to navigate in the VIDEO menu to the entry INPUT STATUS and press ENTER/SELECT to open the INPUT STATUS window.

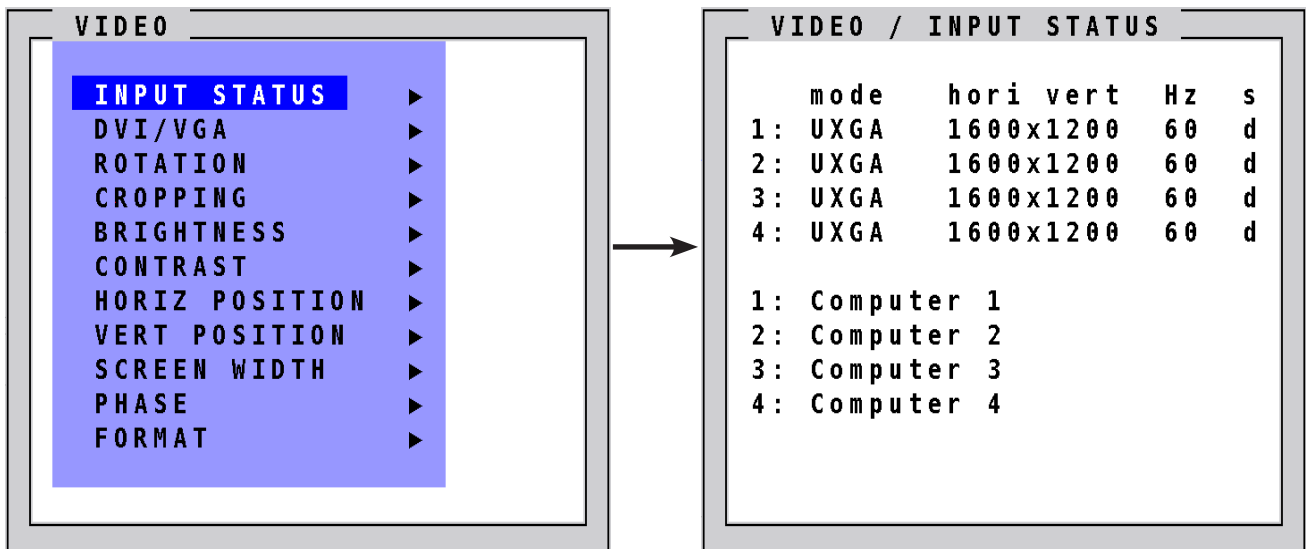

Resolutions at the four video inputs are shown under INPUT STATUS. Resolution recognition at the four video inputs is automatic. Some analog input resolutions may not correctly be detected.

See Annex for a list of video formats supported by SPLITMUX.

S Signal  
a = analog  
d = digital  
g = sync on green  
c = composite sync



# ON SCREEN DISPLAY

## OSD - VIDEO - DVI/VGA

### DVI/VGA

Use arrow keys to navigate in the VIDEO menu to the entry DVI/VGA and press ENTER/SELECT to open the DVI/VGA window.

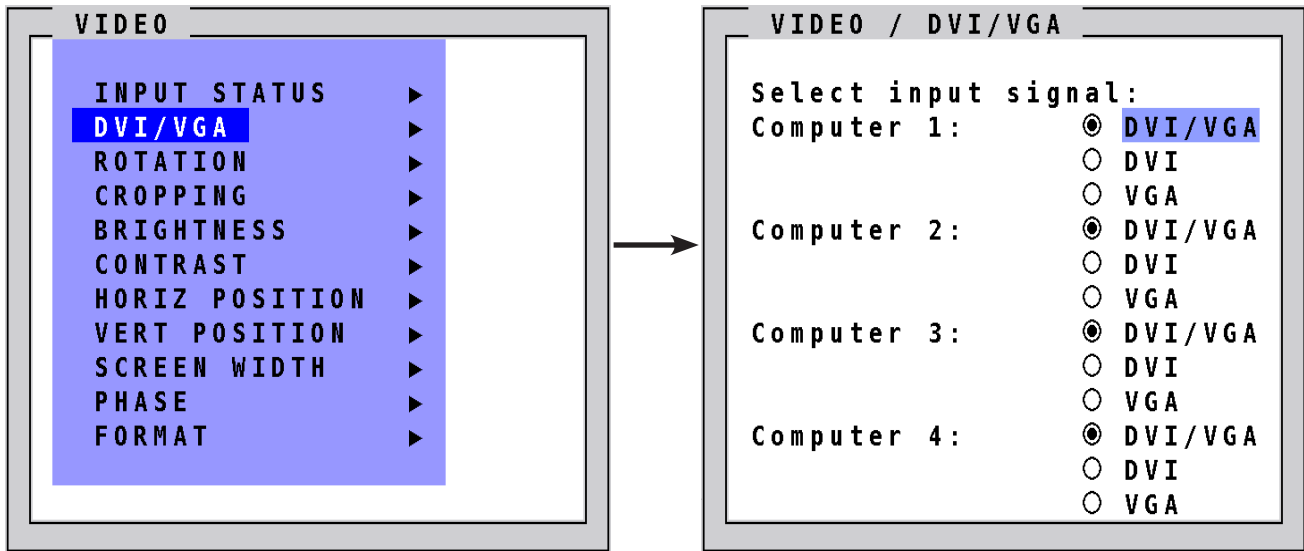

Go to "Select input signal" and define which video signal (VGA or DVI) is to be displayed.

If the setting „DVI/VGA” is selected, SPLITMUX will first check the digital input.

If there is no signal at this input, the analog signal input will be checked.

This function can be used to connect e.g. 8 sources (4x VGA + 4x DVI) via Y-cables to SPLITMUX.

**OSD - VIDEO - ROTATION**

**ROTATION**

Use arrow keys to navigate in the VIDEO menu to the entry ROTATION and press ENTER/SELECT to open the ROTATION window.

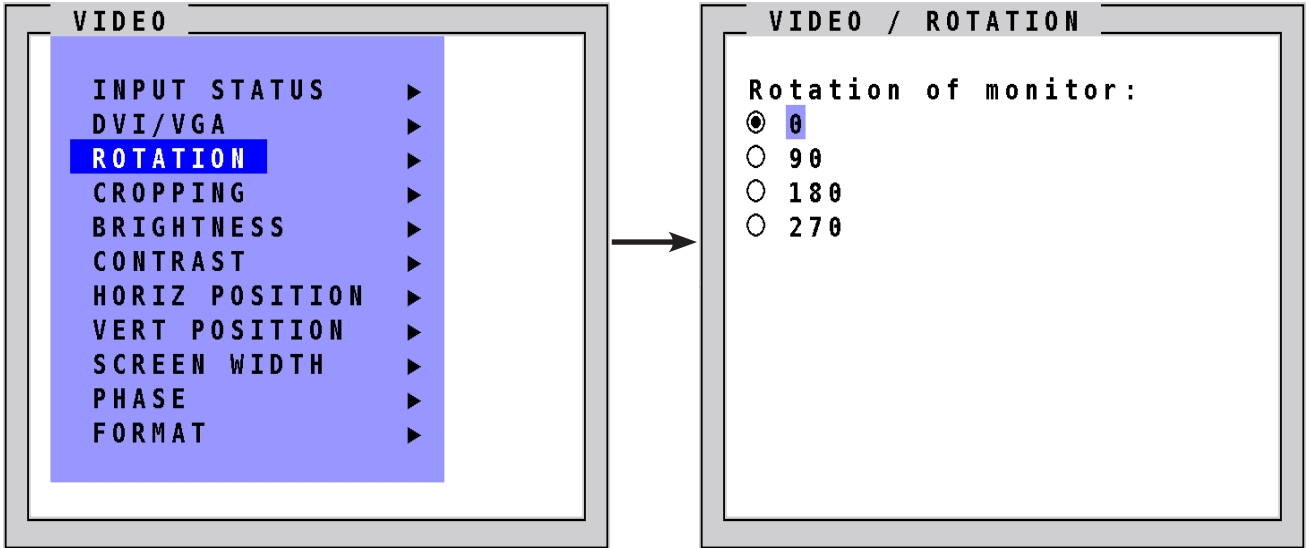

Select the degrees to which you would like to rotate your display. Choose from 0, 90, 180 and 270. Once the rotation degrees have been selected, all of the channel are rotated to the same degree.

**Note:** Once the degrees have been chosen, it may take a few seconds for the display to rotate.

Rotation limitation at 90° and 270°: If the channels overlap, the monitor display should have a total of lines no higher than 2028. If the aspect ratio is not locked in Win mode, size reduction and enlargement cannot both be used simultaneously for each channel. There may be further restrictions not known at the time print.

**Example with 90 degree setting:**

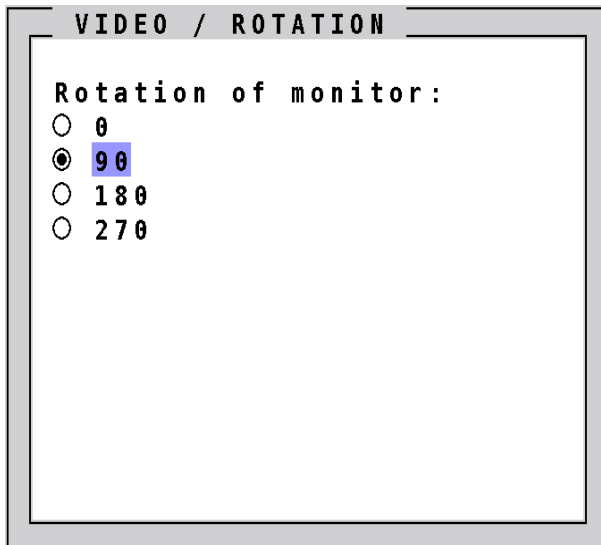

# ON SCREEN DISPLAY

## OSD - VIDEO - CROPPING

### CROPPING

Use arrow keys to navigate in the VIDEO menu to the entry CROPPING and press ENTER/SELECT to open the CROPPING window.

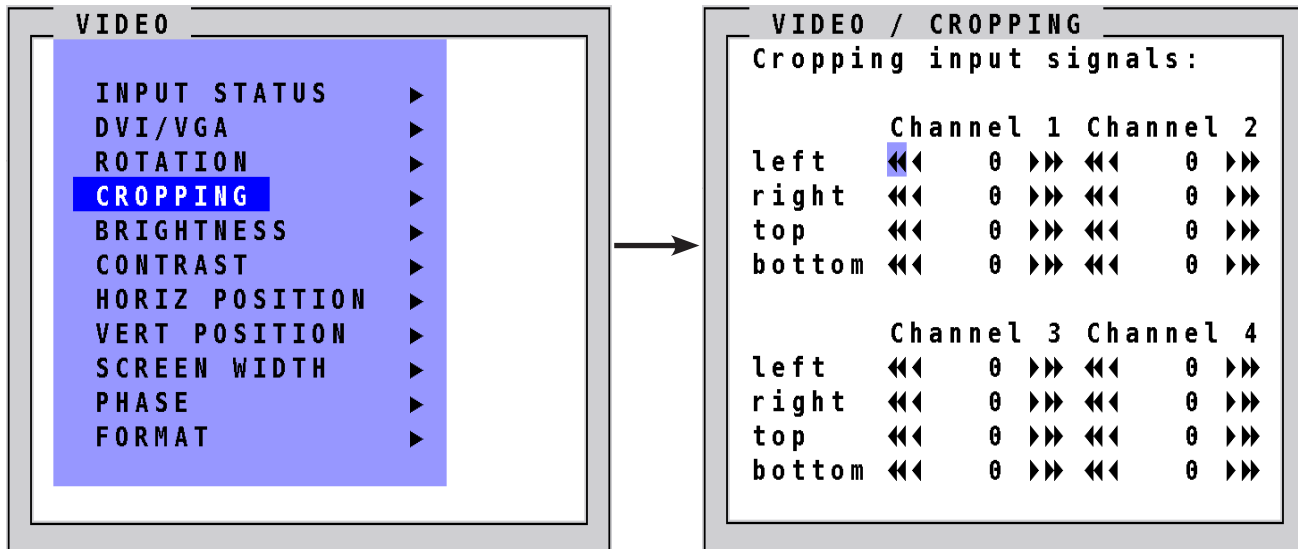

In the window VIDEO/CROPPING, enter a value from 0-999 for the left, right, top and bottom side of the channel to be cropped.

Use the arrows to increase or decrease the value either in single digits or in increments of 30. Alternatively, the right and left arrows of the keyboard may be used to adjust these values.

**Note:** The smallest possible size of each area is 10% of the input signal.

**OSD - VIDEO - BRIGHTNESS / CONTRAST**

**BRIGHTNESS – CONTRAST (with analog input only)**

Use arrow keys to navigate in the VIDEO menu to the entry BRIGHTNESS or CONTRAST and press ENTER/SELECT to open the BRIGHTNESS or CONTRAST window.

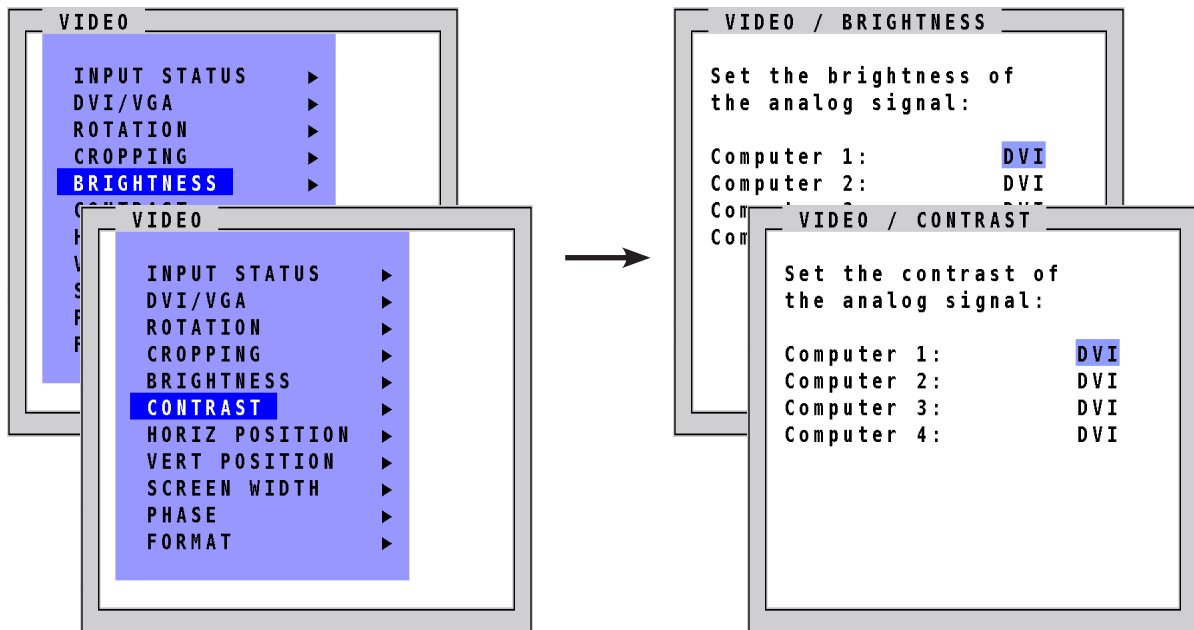

Use this feature to adjust the brightness or contrast of analog video input signals.

# ON SCREEN DISPLAY

## OSD - VIDEO - HORIZONTAL & VERTICAL POSITION

### HORIZ / VERT POSITION (horizontal / vertical position of computer screen) (with analog input only)

Use arrow keys to navigate in the VIDEO menu to the entry HORIZ POSITION or VERT POSITION and press ENTER/SELECT to open the HORIZ POSITION or VERT POSITION window.

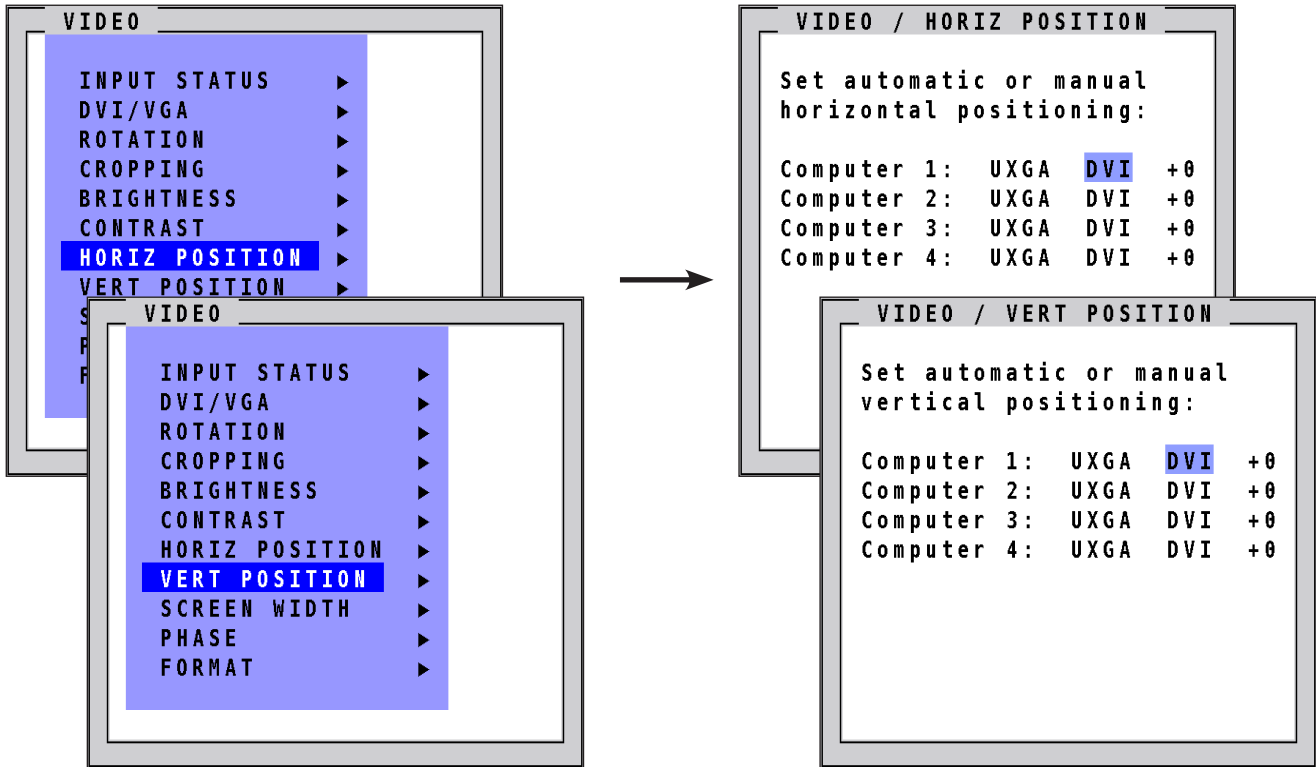

In case of incorrect horizontal position of a computer screen, use this feature to adjust the computer screen manually. Use the arrow keys to navigate to the AUTO/MAN field and set MAN for manual. Use the "+" or "-" keys in the value field to adjust the vertical position between -20 and +20, and the horizontal position between -63 and +63.

**OSD - VIDEO - SCREEN WIDTH / PHASE****SCREEN WIDTH (with analog input only)**

Use arrow keys to navigate in the VIDEO menu to the entry SCREEN WIDTH and press ENTER/SELECT to open the SCREEN WIDTH window.

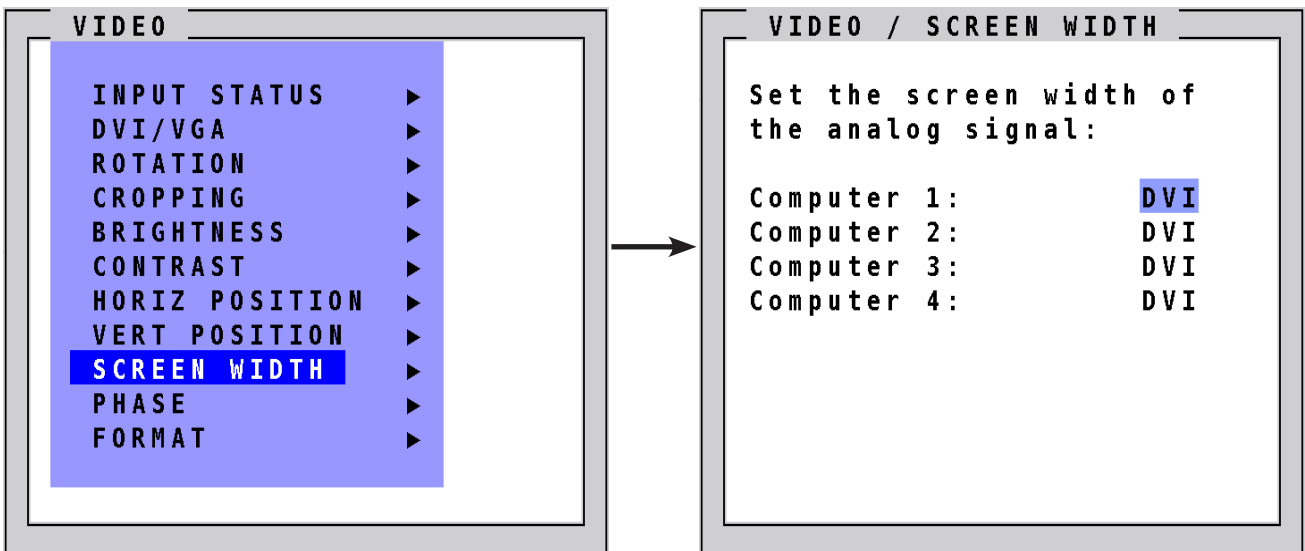

Normally, screen width (number of horizontal pixels) is defined by the VESA standard. If the screen appears blurred, change this setting to improve screen quality.

**PHASE (with analog input only)**

Use arrow keys to navigate in VIDEO menu to the PHASE line and press ENTER/SELECT to open the PHASE window.

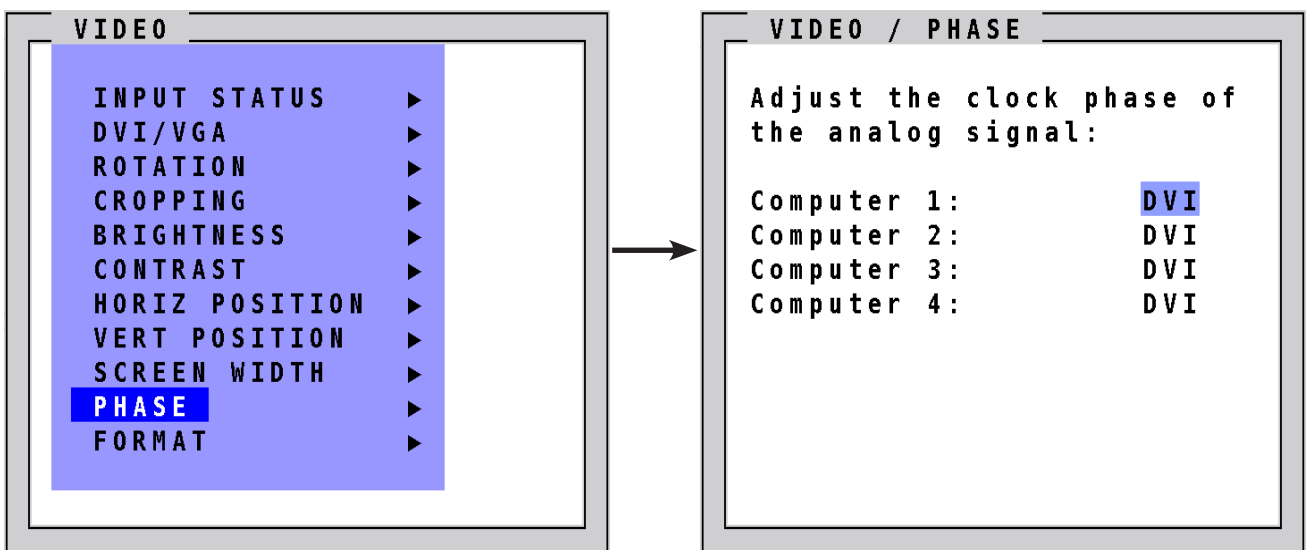

Incorrect phase (sampling time of pixel color value) may result in blurring, bad contrast, or poor legibility. Use this setting to adjust phase.

# ON SCREEN DISPLAY

## OSD - VIDEO - FORMAT

### FORMAT

Use arrow keys to navigate in the VIDEO menu to the entry FORMAT and press ENTER/SELECT to open the FORMAT window.

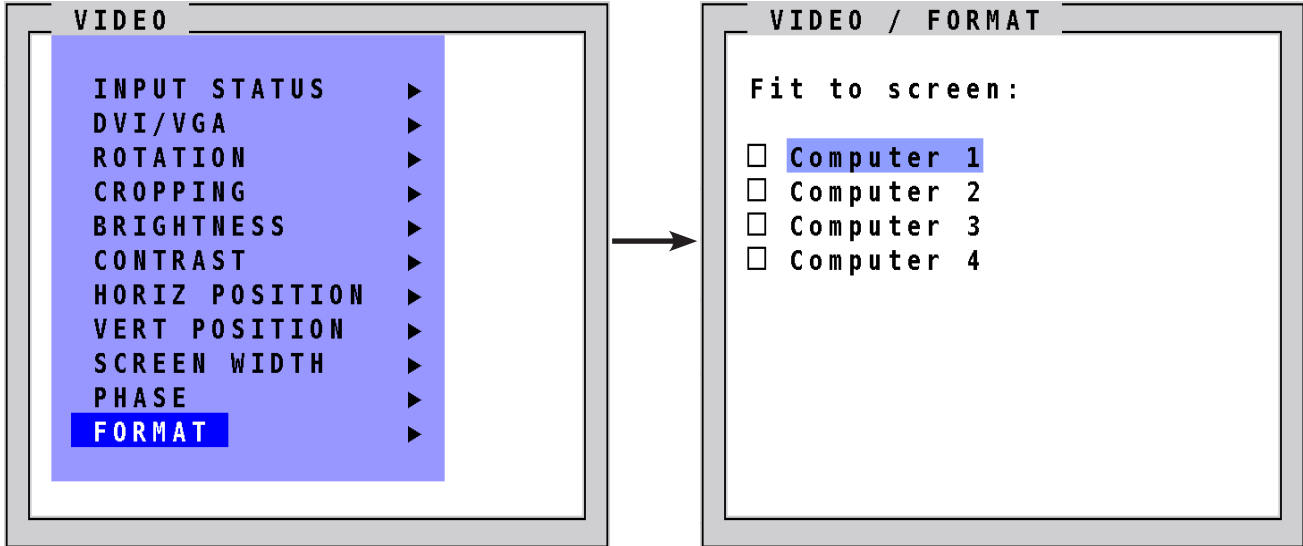

When using a wide-screen monitor (aspect ratio 16:10) in Quad mode, a video input with a different aspect ratio is normally displayed with black borders to the left and right. If „fit to screen” is enabled, the image is resized to fill the entire quadrant in Quad mode.

By default, "fit to screen" is disabled to display each source in its native aspect ratio in display modes (Quad, PiP, Full) of SPLITMUX.

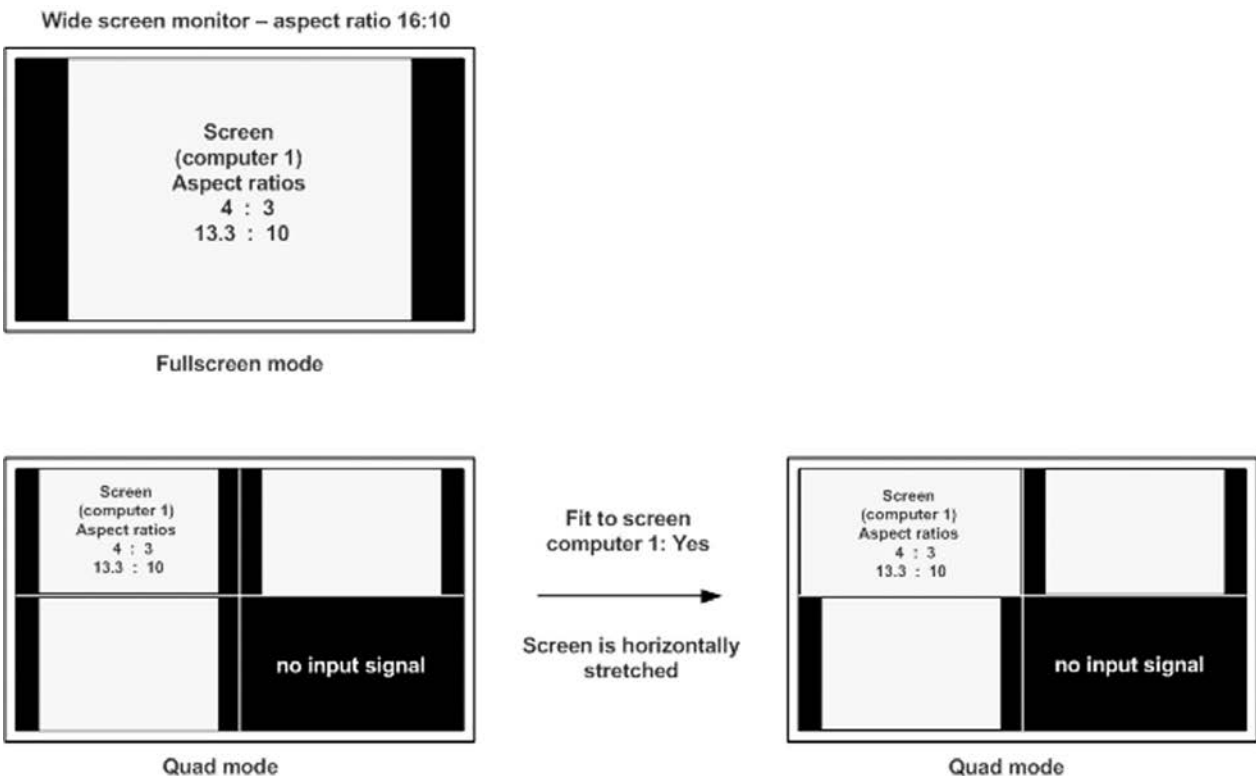

**OSD - VIDEO - FORMAT**

**FORMAT (continued)**

**PiP mode for wide-screen monitors**

If you use a wide-screen monitor (for example with an aspect ratio of 16:10) and the active channel does not have a wide-screen aspect ratio (e.g. 4:3), PiPs are placed aside the full image of the active channel in the black bar on the right side. The full image of the active channel is displayed left-aligned on the screen resulting in a black bar on the right side. Provided appropriate PiP size (20%) is set, PiP images are thus placed entirely outside the full screen channel. No screen content is overlapped. All content of all sources is visible.

Wide screen monitor – aspect ratio 16:10

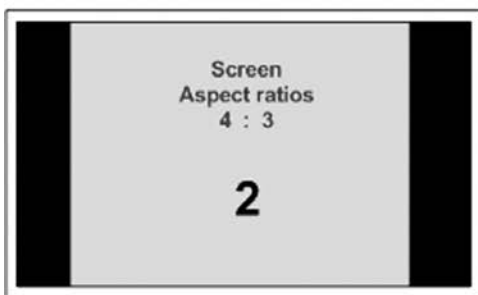

Fullscreen mode

Fullscreen ist positioned on the left-hand side in PiP mode

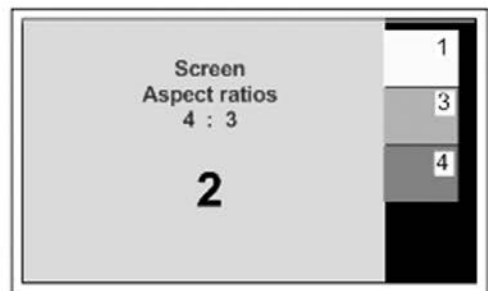

PiP mode



Quad mode



# ON SCREEN DISPLAY

## OSD - COMPUTER - CHANNEL MAPPING

### CHANNEL MAPPING

Use arrow keys to navigate in the COMPUTER menu to the entry CHANNEL MAPPING and press ENTER/SELECT to open the CHANNEL MAPPING window.

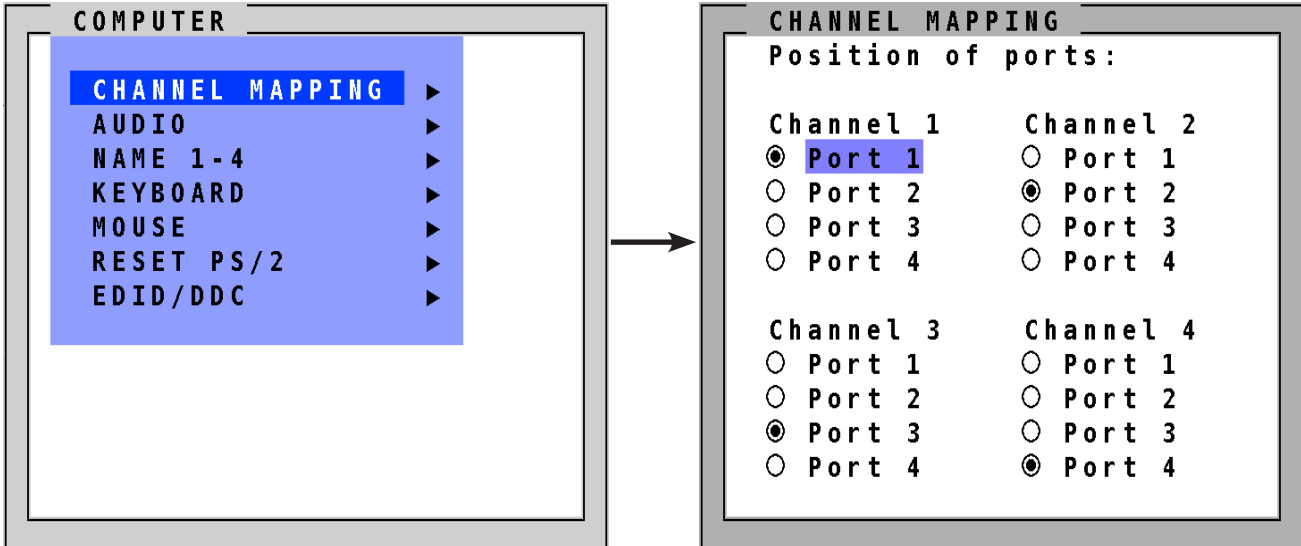

In the CHANNEL MAPPING menu, assignment between physical input ports and logical channels can be changed. This can be useful, for instance, if computer needs to be shown on another position on the quad screen without having to swap the connectors at the inputs.

Use arrow and "+/-" keys to navigate to the physical port that you would like to connect to the channel mentioned on the upper line. Press enter / select to change the connection.

**OSD - COMPUTER - AUDIO**

**AUDIO**

Use arrow keys to navigate in the COMPUTER menu to the entry AUDIO and press ENTER/SELECT to open the AUDIO window.

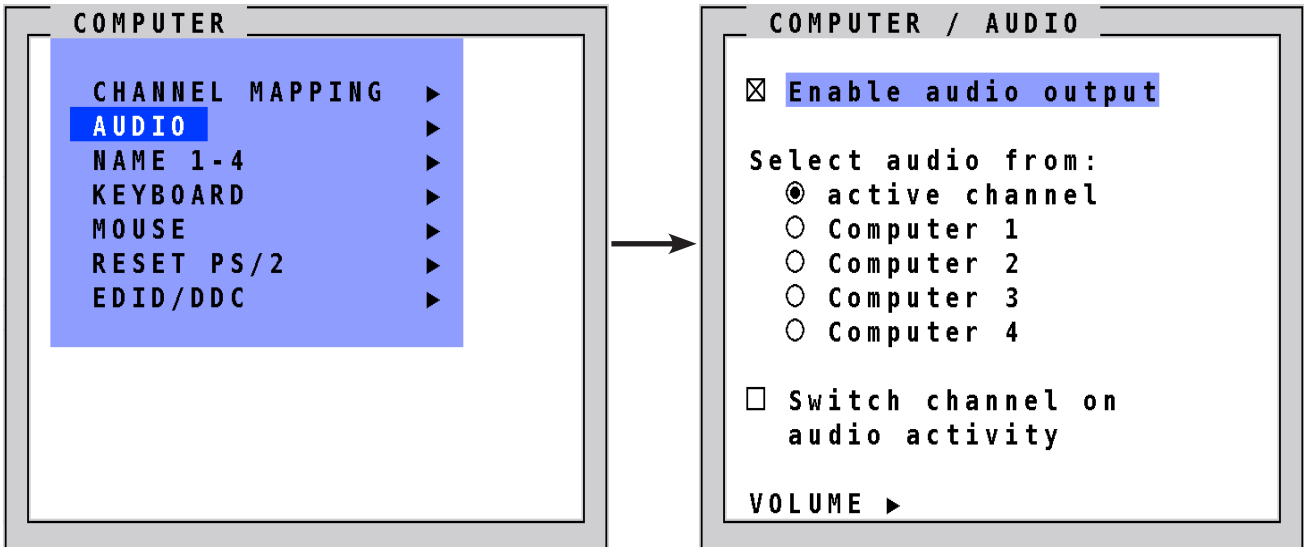

**“Enable audio output”:** To enable or disable the audio output, activate or deactivate the check box “Enable audio output”.

**Selecting audio source:** Select the audio source from the list. To ensure that the audio source is the computer being currently operated, select “active channel” from the list. For a fixed audio source select one of the computers from the list.

**Switch channel on audio activity:** With this setting enabled, SPLITMUX automatically switches to a channel on which an audio signal is detected.

**Volume**

To adapt the volume of the audio sources navigate to VOLUME and press enter/select.

Use this window to adjust the volume for the audio sources in 2 db steps.

Change the volume of each channel with + and -

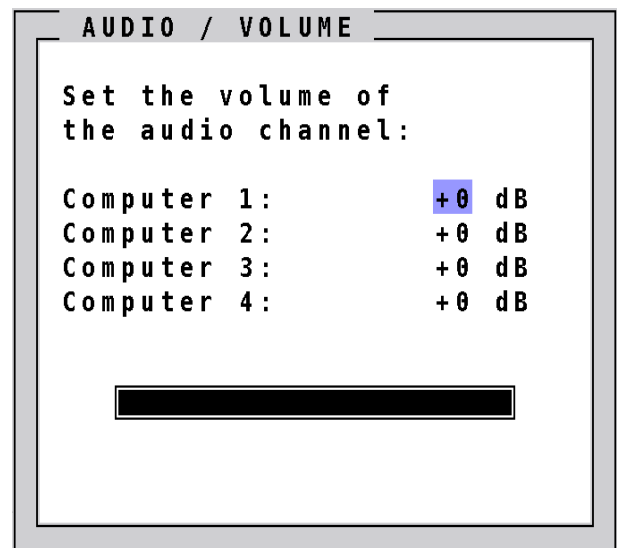

**Note:** This window can also be opened with the hotkeys HK + -/+.

# ON SCREEN DISPLAY

## OSD - COMPUTER - NAME 1-4

### NAME 1-4

Use arrow keys to navigate in the COMPUTER menu to the entry NAME 1-4 and press ENTER/SELECT to open the NAME 1-4 window.

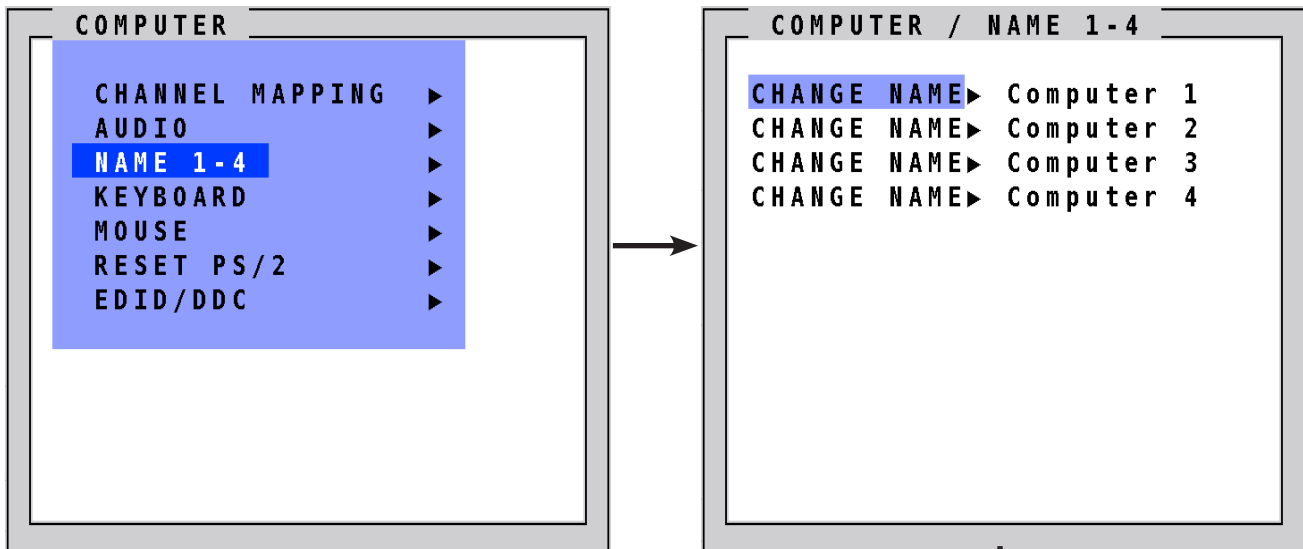

Use the section NAME to assign a name to each of the four windows displayed when HOTMOUSE is in use.

Move the cursor in the edit window using arrows on your keyboard. Press ENTER/SELECT to choose a letter. Press BACKSPACE/FULL to erase.

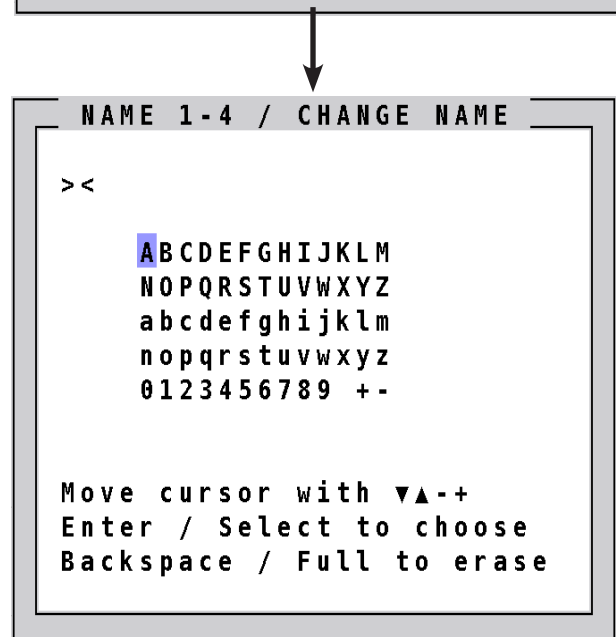

**OSD - COMPUTER - KEYBOARD****KEYBOARD**

Use arrow keys to navigate in the COMPUTER menu to the entry KEYBOARD and press ENTER/SELECT to open the KEYBOARD window.

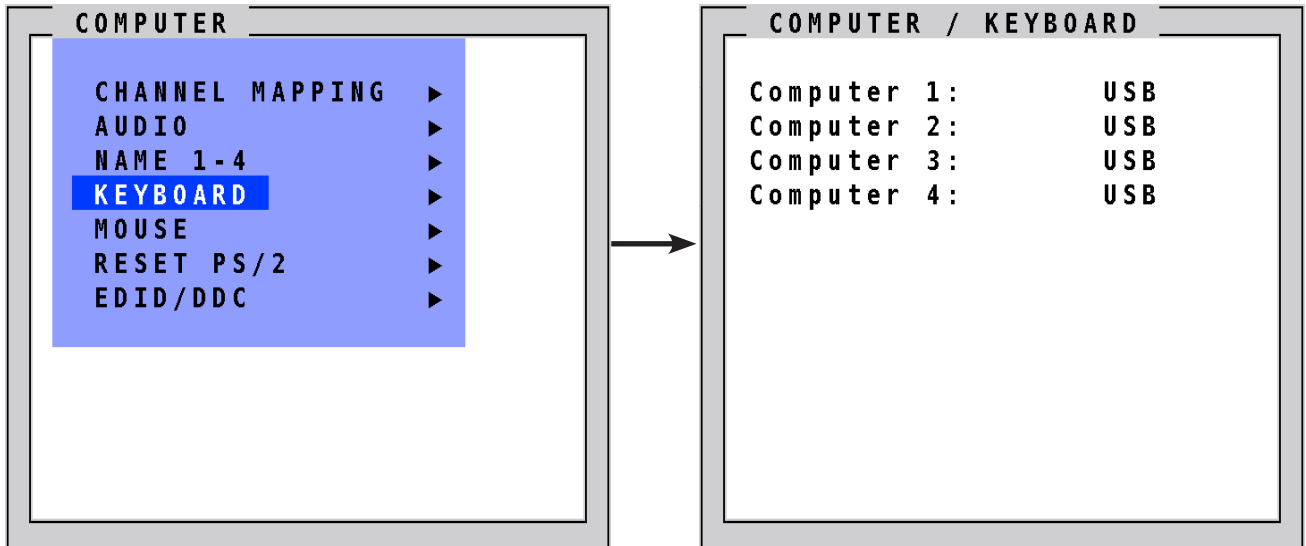

Use this display feature to identify which keyboard type (USB, PC1, PC2 or PC3) has been recognized at which computer port.

## OSD - COMPUTER - MOUSE

### MOUSE

Use arrow keys to navigate in COMPUTER menu to the MOUSE line and press ENTER/SELECT to open the MOUSE window.

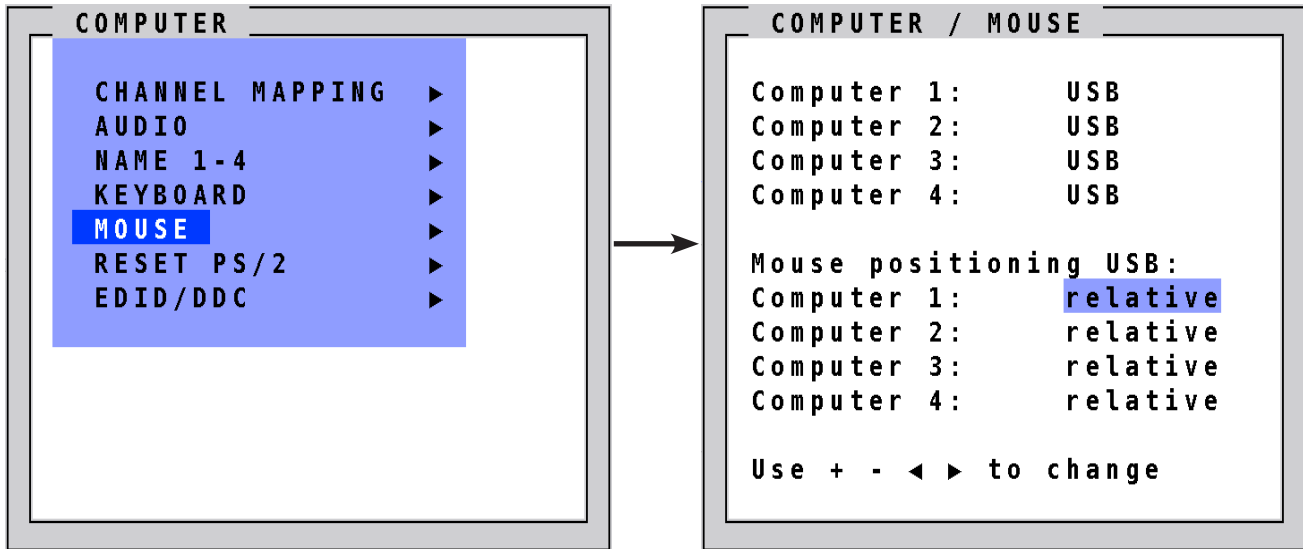

The upper half of the MOUSE window shows which mouse type (USB, PS/2 or PS/2 wheel) has been recognized at which computer port.

### USB – mouse positioning

For USB ports, you may specify absolute or relative mouse positioning.

Choose absolute mouse positioning if a device is connected to the console that supports absolute coordinates, such as graphic trays, screen pads or KVM extenders.

**OSD - COMPUTER - RESET PS/2 / EDID/DDC**

**RESET PS/2**

Use arrow keys to navigate in the COMPUTER menu to the entry RESET PS/2 and press ENTER/SELECT to open the RESET PS/2 window.

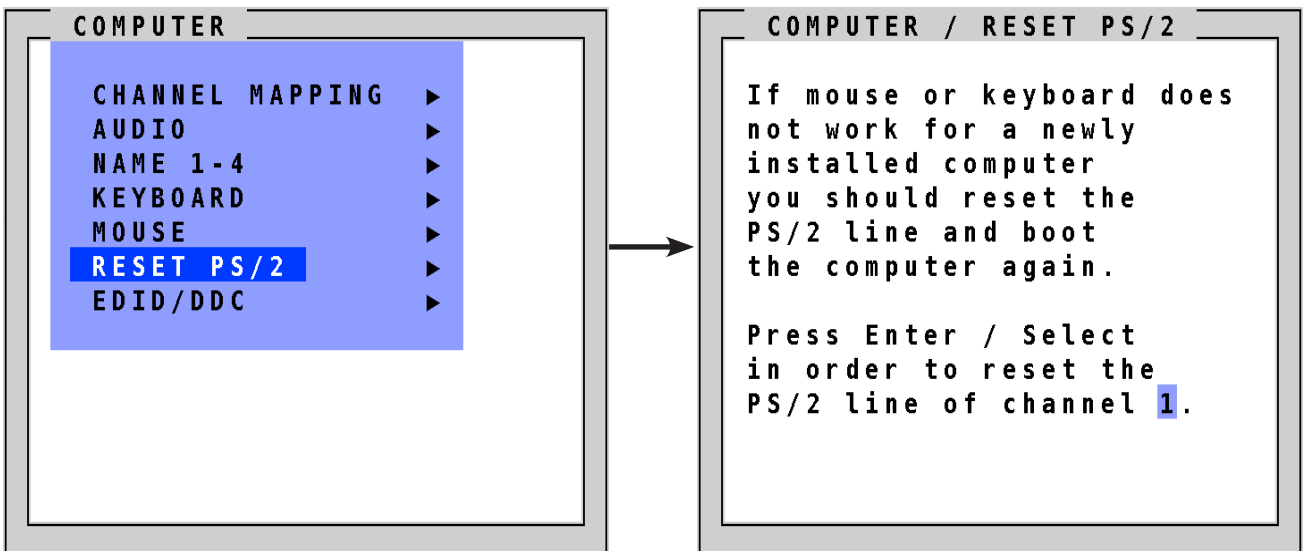

Use arrow keys ◀▶ or “+” and “-” keys to select the channel (1 to 4) you wish to reset and confirm by pressing ENTER/SELECT.

**EDID/DDC**

This window presents an overview of the status of the input EDIDs and the display EDID and allows editing of these.

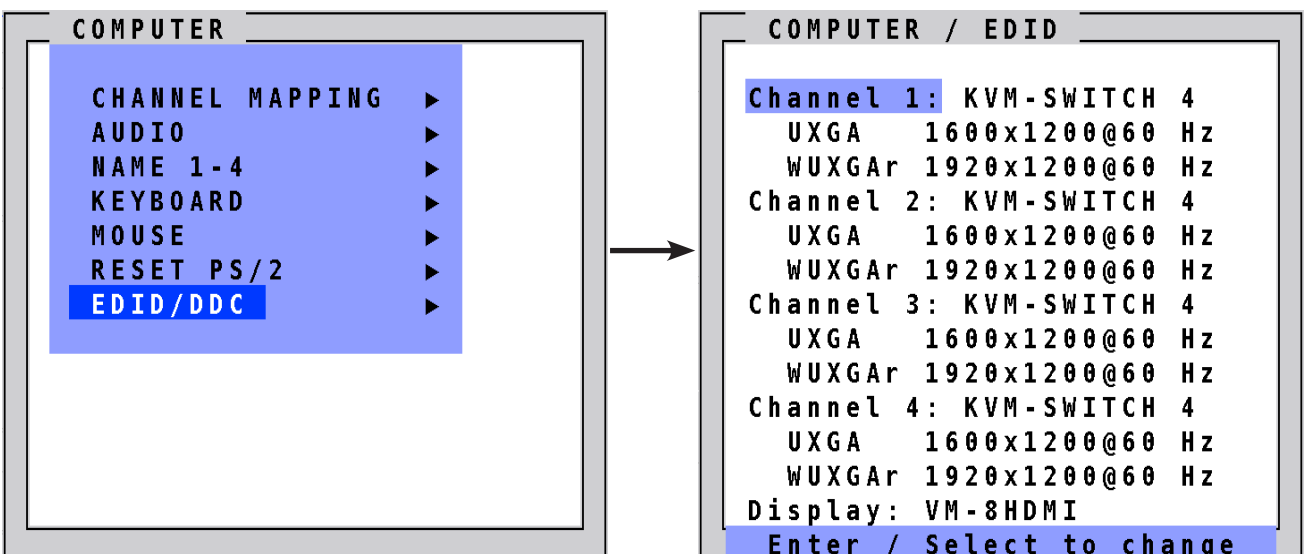

# ON SCREEN DISPLAY

## OSD - COMPUTER - EDID/DDC (continued)

### EDID/DDC (continued)

Use arrow keys to select the channel EDID information.

Press ENTER/SELECT to open the window with detailed settings for this EDID.

```
COMPUTER / EDID
Channel 1: KVM-SWITCH 4
  UXGA 1600x1200@60 Hz
  WUXGAr 1920x1200@60 Hz
Channel 2: KVM-SWITCH 4
  UXGA 1600x1200@60 Hz
  WUXGAr 1920x1200@60 Hz
Channel 3: KVM-SWITCH 4
  UXGA 1600x1200@60 Hz
  WUXGAr 1920x1200@60 Hz
Channel 4: KVM-SWITCH 4
  UXGA 1600x1200@60 Hz
  WUXGAr 1920x1200@60 Hz
Display: VM-8HDMI
Enter / Select to change
```

```
EDID / EDID/DDC
Channel 1:
Choose two video modes:
  UXGA 1600x1200@60 Hz
  WUXGAr 1920x1200@60 Hz
Signal:  (X) digital
         (O) analog
WRITE
WRITE TO ALL INPUTS
SAME AS DISPLAY EDID
```

Select a video mode for the channel using the arrow keys. Press ENTER/SELECT to confirm selection.

```
EDID/DDC / MODE
mode  horiz  vert  Hz
XGA   1024 x  768  60
SXGA+ 1400 x 1050 50
SXGA+ 1400 x 1050 60
UXGA  1600 x 1200 50
→ UXGA 1600 x 1200 60
UXGAr 1600 x 1200 50
UXGAr 1600 x 1200 60
WXGA  1280 x  768  60
WXGA  1360 x  768  60
Press Enter/Select or ▲ ▼
```

**OSD - COMPUTER - EDID/DDC (continued)****EDID/DDC (continued)**



Two freely selectable video modes can be programmed in the input EDID visible to the connected computer at the input port.



It is recommended to program the preferred video modes for the connected signal source.



SPLITMUX also uses these entries to distinguish between confusable analog input video signals. The following groups of analog input signals are difficult to distinguish automatically:



WUXGA 1920x1200 60 Hz  
 UXGA 1600x1200 60Hz  
 UXGA 1600x1200 60Hz with reduced blanking  
 WUXGA 1920x1200 50 Hz  
 UXGA 1600x1200 50Hz  
 UXGA 1600x1200 50Hz with reduced blanking  
 SXGA+ 1400x1050 60Hz  
 WSXGA 1680x1050 60Hz  
 XGA 1024x768 60Hz  
 WXGA 1280x768 60Hz  
 WXGA 1360x768 60Hz

If you experience problems with the automatic input detection of an analog input signal in these groups you can overwrite the automatic detection by programming the expected video signal into the input EDID.

Use arrow keys   to navigate to the first video mode entry and press ENTER/SELECT to open the window with a list of selectable video modes.

In this window use arrow keys   to select the desired line in the list shown on the right and press ENTER/SELECT for the video format.

Use arrow keys   to navigate to the second video mode entry and press ENTER/SELECT to open the window with a list of selectable video modes.

Use arrow keys   to navigate to "Signal" and press ENTER/SELECT to switch between analog or digital. This setting specifies whether the EDID should identify the SPLITMUX as an analog or digital device. Usually it is safe to leave this setting at "digital".

Use arrow keys   to navigate to the following write options:

**WRITE** save the changes in the current input EDID.

**WRITE TO ALL INPUTS** save the changes to all four input EDIDs.

Alternatively, the EDID data of the connected display can be used. To do this, navigate to SAME AS DISPLAY EDID and press ENTER/SELECT

**SAME AS DISPLAY EDID** write the contents of the display EDID to the current input EDID.

Press ENTER/SELECT to start the selected write option and wait until "successful" is displayed in the bottom status line. At this point, the EDID data can be written to one or all of the four channels.

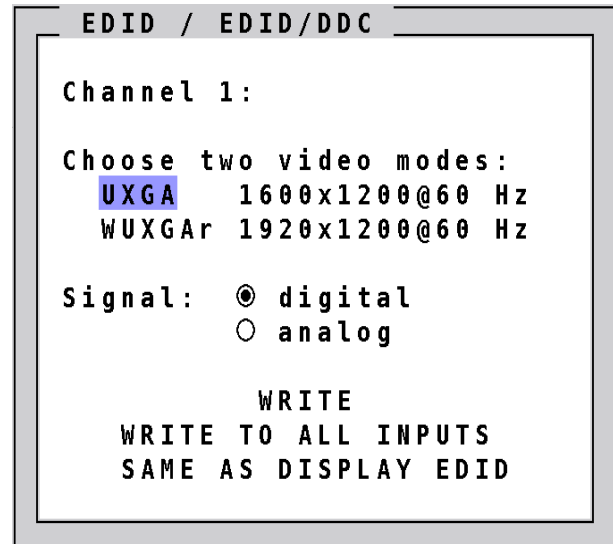

**Note:** If the EDID data of the connected video source is used, the switch behaves as if the display is connected directly to the source.



# ON SCREEN DISPLAY

## OSD - COMPUTER - EDID/DDC

### EDID/DDC (continued)

**Note:**

Please keep in mind that this setting will overwrite the automatic analog input mode detection. If you connect a different video source, or change the video mode from the PC, you may need to change this setting again to get correct results. For the detection of digital input signals this setting has no effect.

Alternatively, the display EDID data can be copied to the inputs:

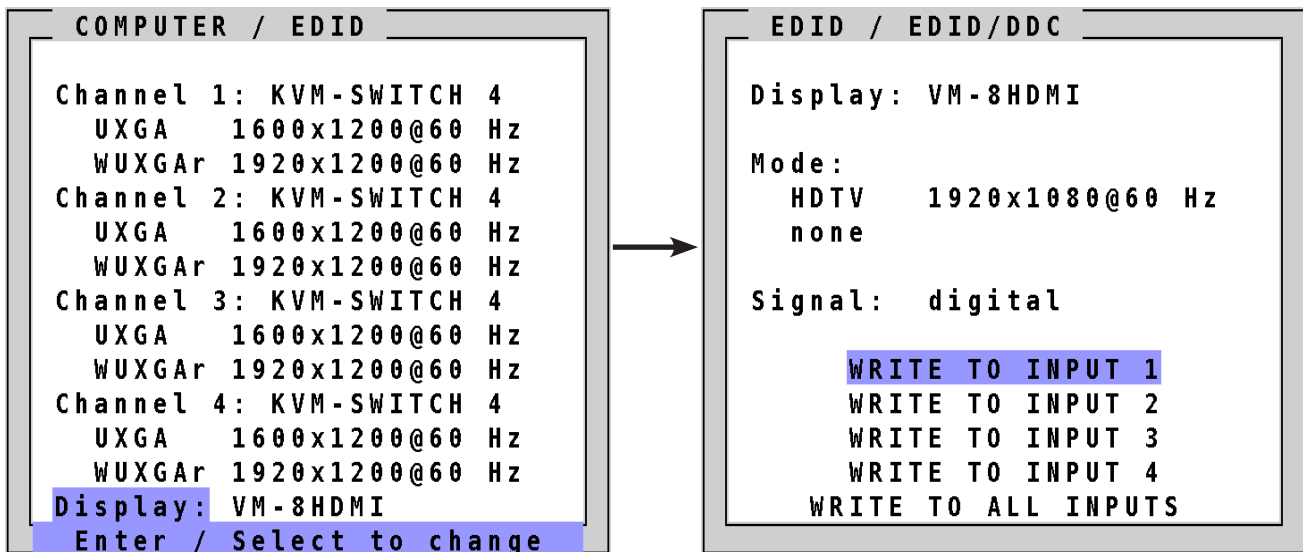

An overview of the contents of the display EDID is seen above.

It has the following write options:

WRITE TO INPUT 1	write the monitor EDID to input 1
WRITE TO INPUT 2	write the monitor EDID to input 2
WRITE TO INPUT 3	write the monitor EDID to input 3
WRITE TO INPUT 4	write the monitor EDID to input 4
WRITE TO ALL INPUTS	write the monitor EDID to all inputs

**Note:**

The content of the input EDIDS can be reset to default by the OSD function CONFIGURATION / FACTORY RESET.

**OSD - USB DEVICE 1-4**

**USB Device 1-4**

SPLITMUX supports and switches transparent USB 2.0 devices such as printer, camera, 3D mouse, finger printer, and external memory. (Example: Connect a memory stick to copy data from one computer to the stick, and from the stick to another computer connected to SPLITMUX: Data can be copied between computers without being networked.)

Use arrow keys to navigate in the OSD menu to the entry USB DEVICE 1-4 and press ENTER/SELECT to open the window.

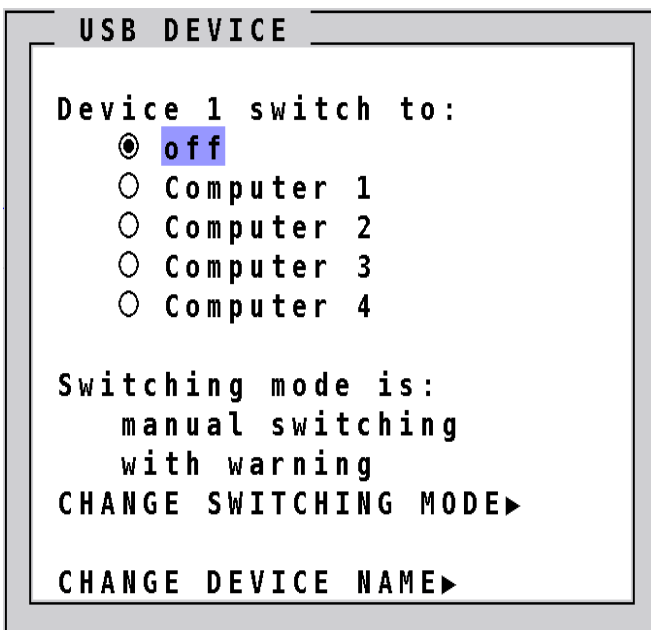
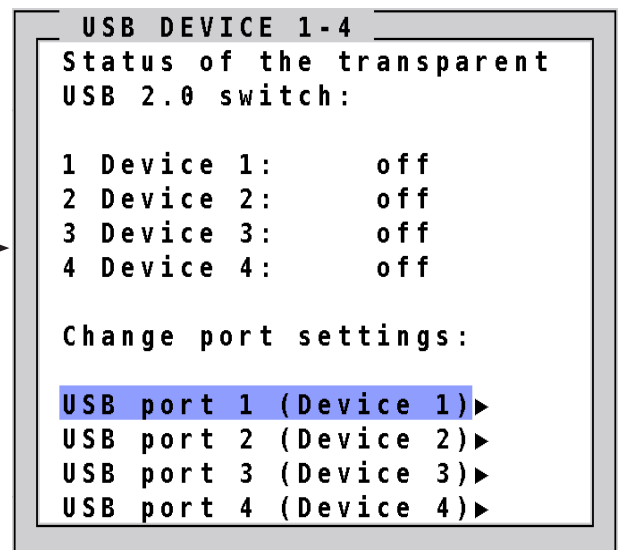
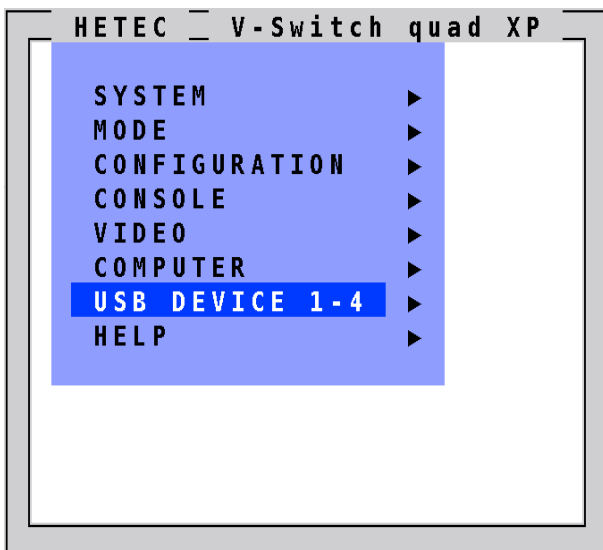

**Status display of the transparent USB 2.0 switch.** Connections from USB port to computer are shown.

**OFF:** Port is not switched to a computer. A USB device may be connected, but it is not switched to a computer.

**Computer (1-4):** Port is switched to one of the computers.

To change port and switch settings use arrow keys to select one of the four USB ports and open its submenu by pressing ENTER/SELECT.

**Device 1 switch to:** Off by default. To manually switch this USB port to one of the four computers, use arrow keys to select one of the four computers and press ENTER/SELECT.

## OSD - USB DEVICE 1-4 - SWITCHING MODE

### USB Device 1-4 (continued)

The following options can be selected for the USB port: Manual switching, change switching mode, change USB device name.

#### Switching mode:

By default, switching mode is "manual switching with warning".

To change the switching mode use the arrow keys to navigate to "CHANGE SWITCHING MODE" and press ENTER/SELECT.

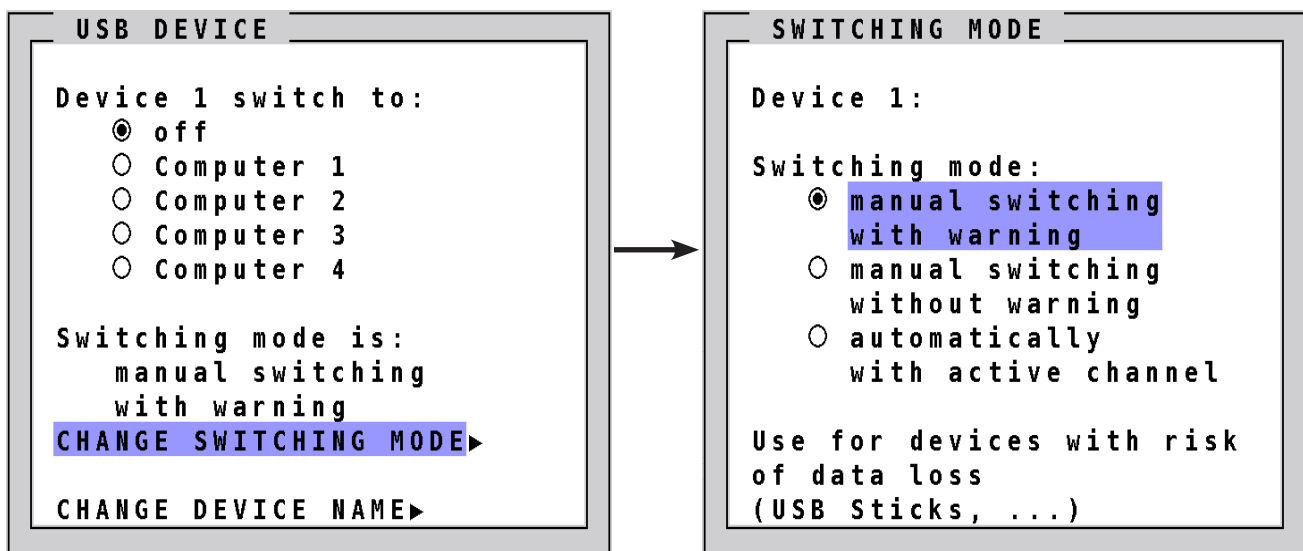

Use arrow keys to chose one of the following modes to change the switching mode:

- 1. Manual switching with warning:** This mode allows switching the USB port manually by selecting one of the computers connected. But before the switch is executed the following warning message is displayed: "In order to prevent data loss, stop the USB device before switching!" To switch, press ENTER/SELECT. This switching mode is recommended for USB devices with risk of data loss (e.g. USB stick, printer, external memory)
- 2. Manual switching without warning:** This mode allows switching the USB port manually by selecting one of the computers connected. The switching is executed immediately. This switching mode is recommended for USB devices without risk of data loss.
- 3. Automatically with active channel:** In this mode, the USB device/port is always switched automatically with the active channel. When switching channel/computer this USB device/port will automatically be switched to the activated channel/computer.

#### Note:

After power on, all USB devices are disconnected from computers except devices with switching mode "automatically with active channel".

**OSD - USB DEVICE 1-4 - CHANGE NAME****USB Device 1-4 (continued)****Change device name:**

In the „USB DEVICE. / USB DEVICE” menu chose „Change device name” and press ENTER/SELECT to change the name of the connected USB device.

Use the keyboard to rename the USB device or use the front panel buttons (as described in the OSD). Exit the menu. The new name will automatically be saved and displayed in the other menus.

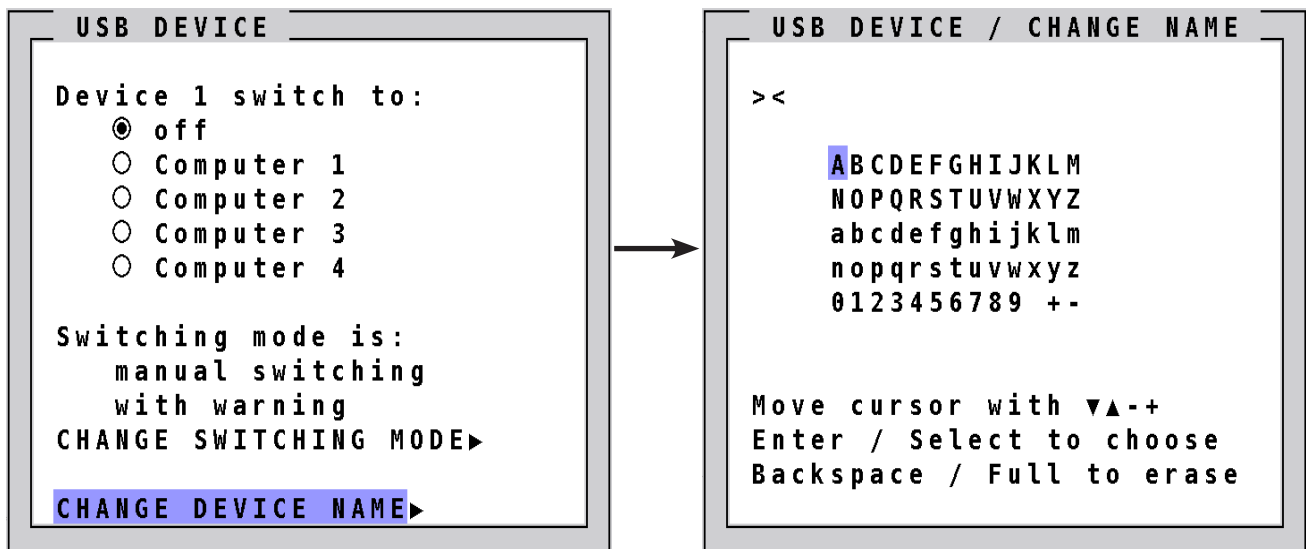
**Note:**

Use hotkey + „u” (by default: hotkey = Ctrl + Alt) to quickly access the USB DEVICE 1-4 menu. This allows quick access to this menu when switching manually.

To directly open the switching menu of e.g. USB device/port 1 use hotkey + „F1” (by default: hotkey = Ctrl + Alt).

# ON SCREEN DISPLAY

## OSD - HELP - HOTKEY / ABOUT / CONTACT

Use arrow keys to navigate in the HELP menu to the desired line and press ENTER/SELECT to open the corresponding window.

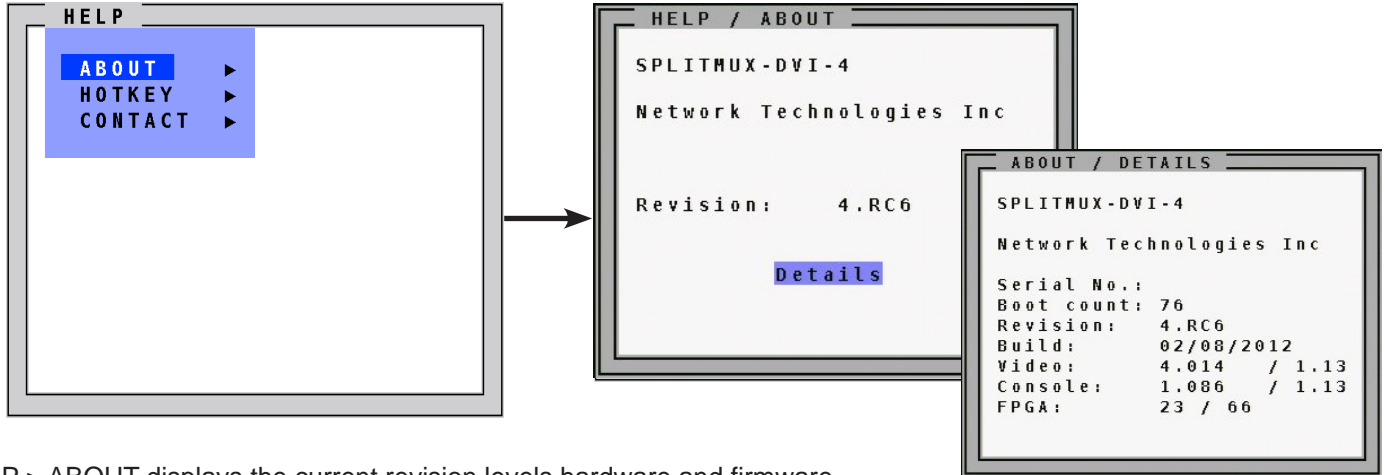

HELP > ABOUT displays the current revision levels hardware and firmware.

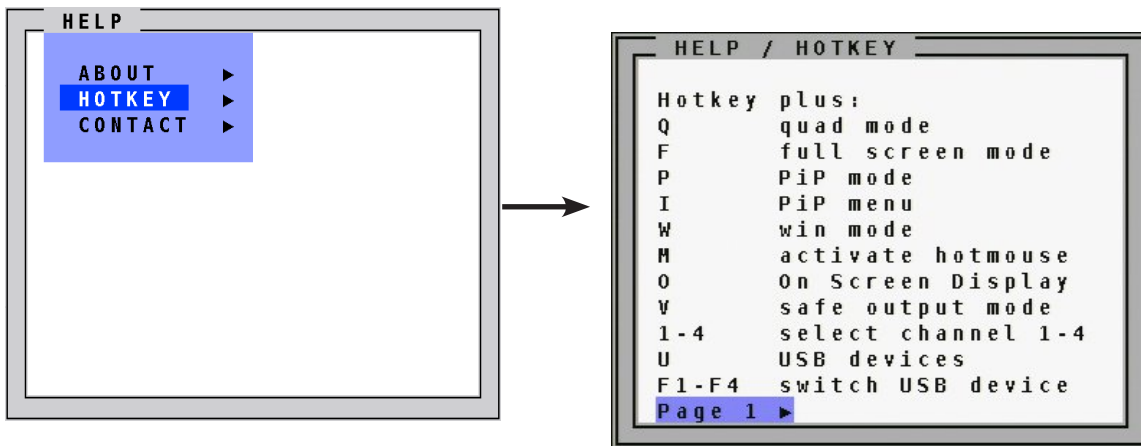

HELP > HOTKEY provides a guide to hotkey shortcuts.

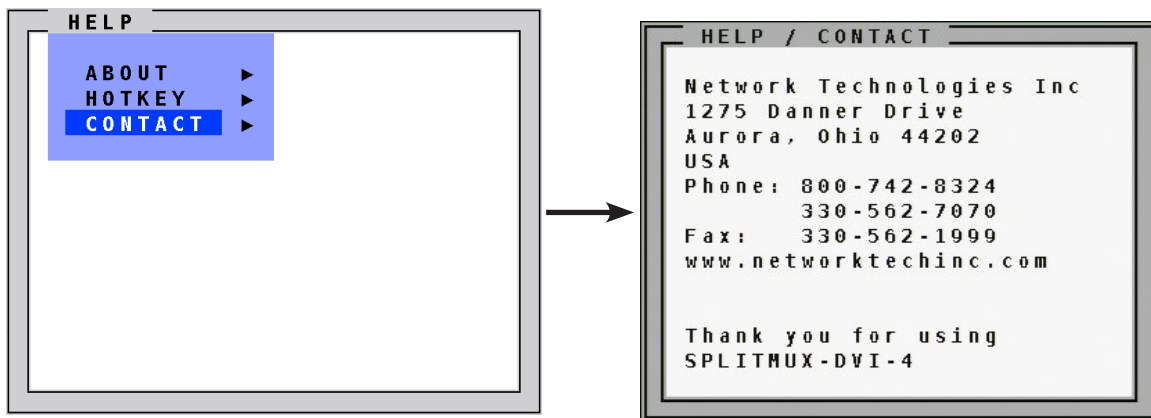

HELP > CONTACT window contains information on how to contact NTI support.

## HOTMOUSE - ACTIVATING HOTMOUSE CURSOR

### Hotmouse

Hotmouse is an exclusive function offered by NTI SPLITMUX. It works with your standard mouse or trackball and touch screens. Similar to using hotkeys on your keyboard, Hotmouse is a quick and comfortable way to operate SPLITMUX simply with your standard mouse, trackball, or touch screen. No software or additional hardware is required.

When activated, your mouse cursor becomes hotmouse cursor - a numbered arrow - that allows performing all hotmouse functions.

### Activating the hotmouse cursor

To activate **hotmouse cursor** move your mouse on the console four times in a rapid horizontal shaking motion or with hotkey + M.

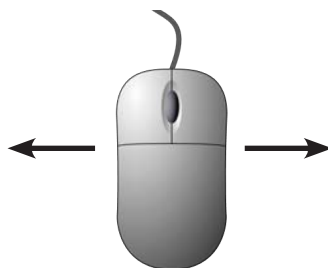

The hotmouse cursor can also be activated via touch screen: tap the screen twice, and leave your finger pressed on the touch screen after the second tap (tap – hold, like a double click without lifting the finger on the second click), until the hotmouse menu opens. Now click outside the hotmouse menu to open the hotmouse cursor.

Close the hotmouse by double clicking or with hotkey + M.

The hotmouse cursor changes its look depending on its position on the screen (arrows in vertical or horizontal direction, and number of channel).



Housemouse  
cursor



Vertical positioning of  
PiP images / Resize in  
Win mode



Resize  
window or PiP



Move  
window

Use the hotmouse cursor to perform the following functions:

- in Fullscreen mode:** - Switch to another fullscreen channel
- in Quad mode:** - Select another active channel (keyboard, mouse)
- in PiP mode:**
  - Modify position and size of PiP images
  - Change active channel
- in Win mode:**
  - Select mode for resize, channel select, and select options (hotmouse menu)
  - Modify position and size of Windows
  - Change active channel

# HOTMOUSE

## HOTMOUSE CURSOR IN FULLSCREEN MODE / QUAD MODE

### Hotmouse Cursor in fullscreen mode

When you activate the hotmouse cursor in Fullscreen mode, PiP images of the other channels are temporarily displayed to allow you to switch to another channel.

### Switching to another fullscreen channel

Activate hotmouse cursor. Move the hotmouse cursor over the PiP image of the channel that you wish to activate and click the **left** mouse button.

#### Example: Switch from channel 2 to channel 3

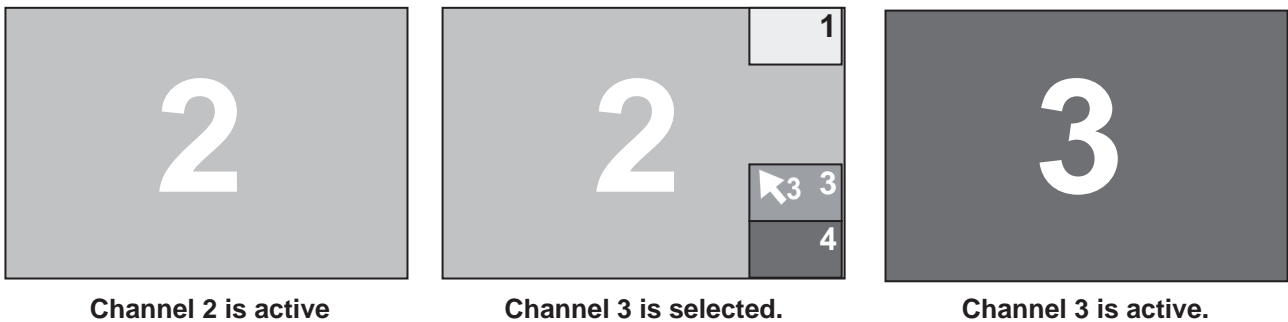

### Hotmouse cursor in Quad mode

#### Switching active channel (mouse, keyboard)

Activate Hotmouse Cursor. To change the active channel (switching mouse and keyboard), position the Hotmouse Cursor in the respective channel field (1 to 4) and press the left mouse button.

**Note:**

When you move into another channel field, the channel number in the Hotmouse Cursor changes.

#### Example: Switch active channel from 1 to 3

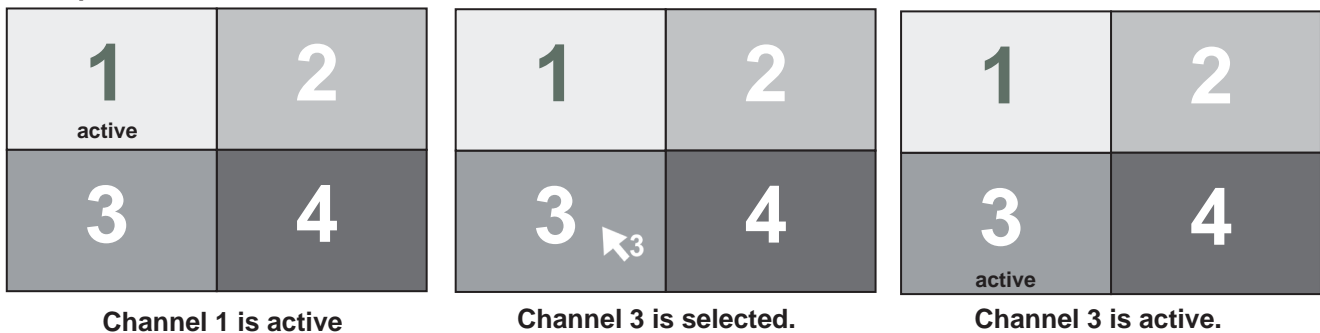

## HOTMOUSE CURSOR IN PIP MODE

### Hotmouse Cursor IN PIP MODE

#### Change active channel

Enable Hotmouse Cursor. Move the Hotmouse Cursor to the PiP-image of the channel you wish to activate and press the left mouse button.

**Note:**

When the Hotmouse Cursor moves over a PiP-image, its appearance changes (arrows, channel number).

#### Example: Switch from channel 2 to channel 3

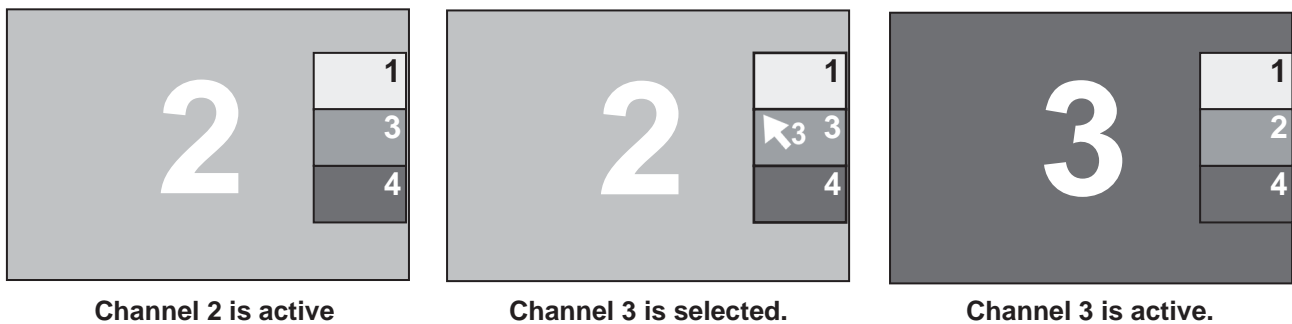

#### Vertical positioning of PiP images

Activate Hotmouse Cursor. Move the Hotmouse Cursor to the PiP-image area, hold down the left mouse button and drag the PiPs to the desired vertical position.

**Note:**

As soon as the Hotmouse Cursor moves over a PiP image, its appearance changes (arrows pointing in vertically).

#### Example: Move PiP images upward

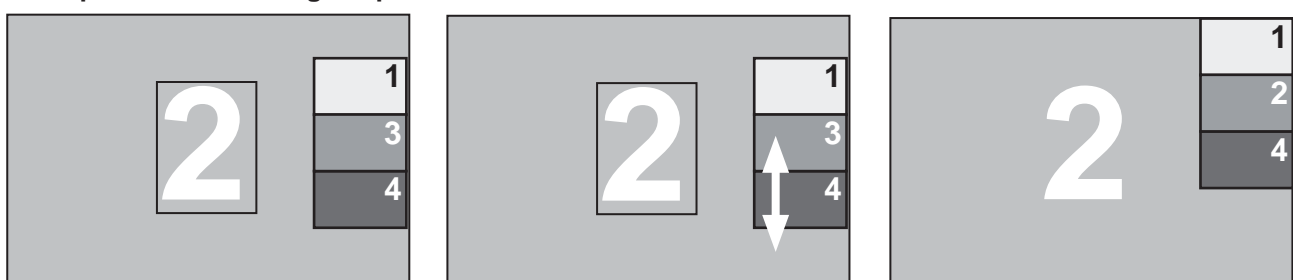



## HOTMOUSE CURSOR IN PIP MODE

### Hotmouse Cursor in PIP MODE (continued)

#### Modify size of PiP images

Activate Hotmouse Cursor and move to the left edge of the PiP image area until horizontal arrows appear in the Hotmouse Cursor. Hold down the left mouse button and drag the Hotmouse Cursor to the left to increase PiP image size, or to the right to reduce PiP image size.

**Note:**

As soon as the Hotmouse Cursor moves to the left edge of the PiP image area, its appearance changes (horizontal arrows, channel number).

#### Scaling PiP images up

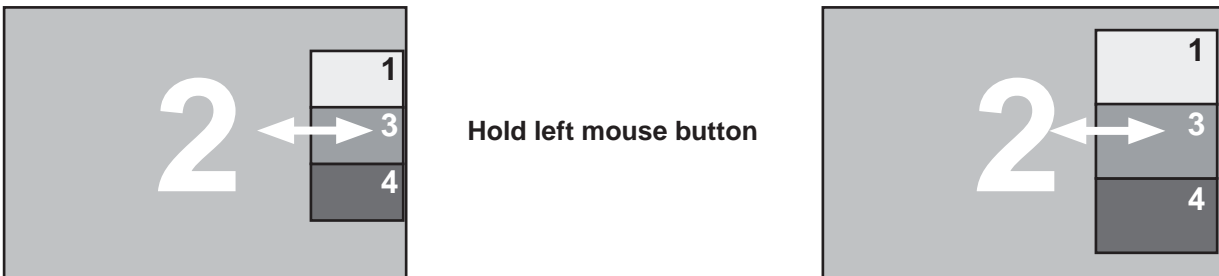

#### Scaling PiP images down

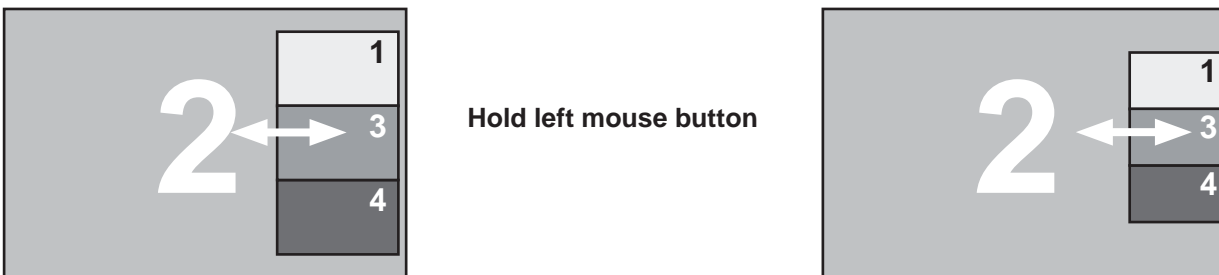

## HOTMOUSE CURSOR IN WIN MODE

### Hotmouse Cursor in Win MODE

#### Change active channel

Enable Hotmouse Cursor. Move the Hotmouse Cursor to the window of the channel you wish to activate and press the left mouse button.

**Note:** When the Hotmouse Cursor moves over a window, its appearance changes (arrows, channel number).

**Note:** To close the Hotmouse Cursor, left double click or use hotkey + M in Win mode.

#### Example: Switch from channel 2 to channel 3

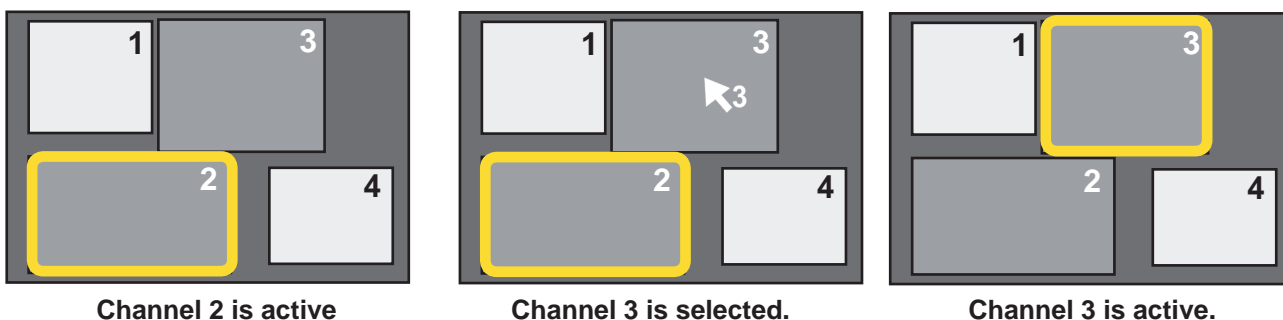

#### Resizing of windows

Activate Hotmouse Cursor. Move the Hotmouse Cursor to the window area, hold down the left mouse button and drag the window to the desired size.

**Note:**

As soon as the Hotmouse Cursor moves over a window, its appearance changes (arrows pointing vertically or horizontally).

#### Example: Resizing windows

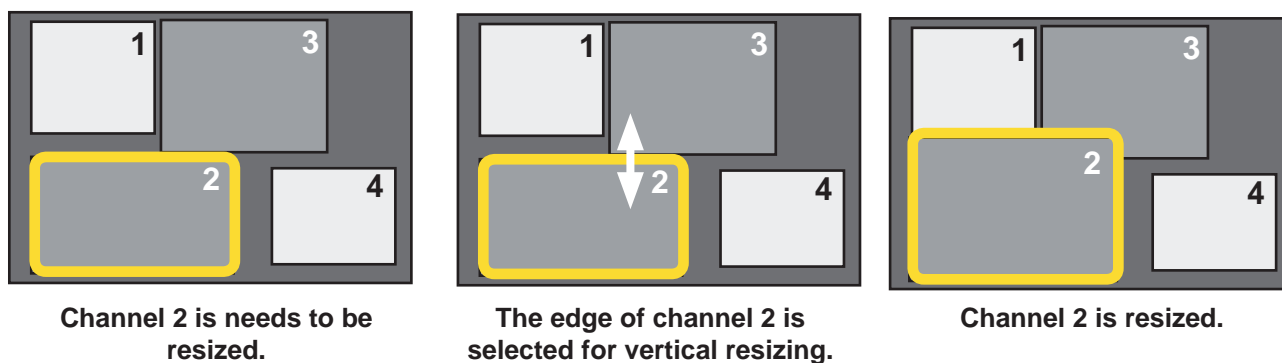

## HOTMOUSE CURSOR IN WIN MODE

### Hotmouse Cursor in Win MODE (continued)

#### Repositioning windows

Enable Hotmouse Cursor. Move the Hotmouse Cursor to the window that you wish to move and press the left mouse button.

**Note:** When the Hotmouse Cursor moves over a window, its appearance changes (arrows pointing up, down, left and right.).

---

#### Example: Repositioning the windows

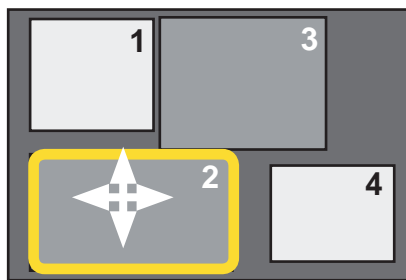

Channel 2 is active and the hotmouse is activated

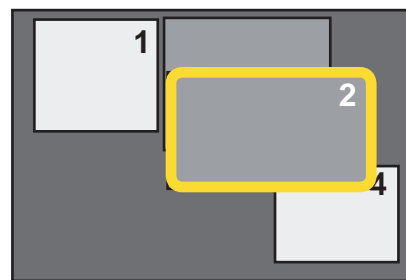

Channel 2 is moved to a new location on the screen..

Move the hotmouse cursor to the top right corner of the signal window, and the following buttons will appear:

- O = Open OSD hotmouse context menu
- S = Swap signal windows. After this is selected, the other window is clicked.
- R = Toggle aspect ratio locking for current window

## HOTMOUSE MENU - ACTIVATING / OPERATING

### Hotmouse Menu - ACTIVATING

Activate Hotmouse Cursor and press the right mouse button to open the Hotmouse Menu. The Hotmouse Menu can also be opened via touch screen: tap the screen twice, and leave your finger pressed on the touch screen after the second tap (tap – hold, like a double click without lifting the finger on the second click), until the Hotmouse Menu opens.

By clicking outside the Hotmouse Menu, you can open the Hotmouse Cursor to enlarge and reposition PiPs (only in PiP mode), switch channels and modify Win Mode.

After you are finished using the Hotmouse Cursor, the Hotmouse Menu will reopen. Menu appearance varies depending on display mode (Full / Quad / PiP / Win). This menu allows you to carry out switching operations and change display mode settings.

### Hotmouse Menu - OPERATING

The Hotmouse Menu allows you to carry out switching operations and to enter PiP settings by mouse click (left mouse button).

Click Help on the Hotmouse Menu for information on the individual symbols.

```

HOTMOUSE

Channel: 1 →2  3  4
Mode:    full  quad →PiP
        win1 win2 win3 win4
single:  fixed  direct
        scan
triple:  →gap   no gap
        tile

PiP zoom:      Yes →No
PiP offset:    ◀◀ 0% ▶▶
PiP size:      ◀◀ 15% ▶▶

CLOSE          HELP

```

### Hotmouse Menu in PiP-mode

Click with the left mouse button on the arrow symbols to either increase or decrease the values in question. Clicking on the outer arrow symbols sets the minimum or maximum value.

After having completed the settings, click on CLOSE to close the Hotmouse Menu window and exit the Hotmouse Function.

```

/ HELP

Select active channel.
Select mode.
Select PiP settings.

→ value is selected by user
◀ decrease value
▶▶ decrease big step
▶ increase value
◀◀ increase big step

CLOSE

```

Click on HELP to open the HOTMOUSE HELP window.

# HOTMOUSE

## Hotmouse Menu - MODES

### Hotmouse Menu - MODES

The individual modes can be set as follows:

### Hotmouse Menu - QUAD MODE

Use the mouse to navigate to a channel in the Hotmouse Menu and click the left mouse button to activate it. You can also switch to a different mode with the left mouse button.

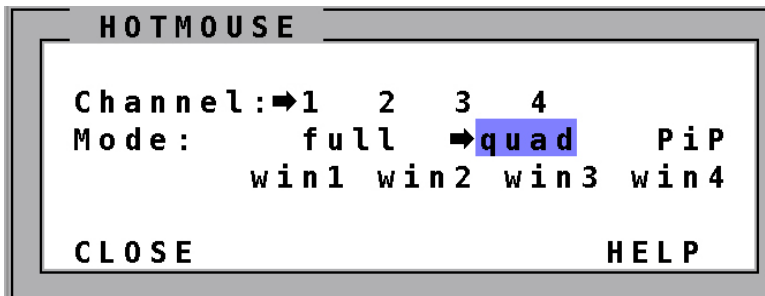

Hotmouse Menu in Quad mode

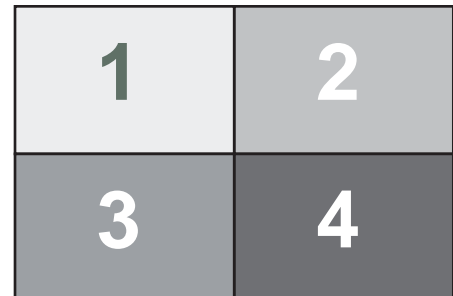

Quad mode

### Hotmouse Menu - FULLSCREEN MODE

Use the mouse to navigate to a channel in the Hotmouse Menu and click the left mouse button to activate it. You can also switch to a different mode with the left mouse button.

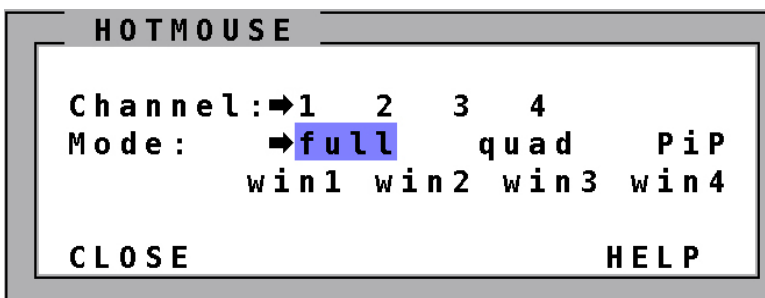

Hotmouse Menu in Fullscreen mode



Fullscreen mode

## Hotmouse Menu - MODES

### Hotmouse Menu – MODES (continued)

### Hotmouse Menu – PIP MODE

Use the mouse to navigate to a channel in the Hotmouse Menu and click the left mouse button to activate it. Change position and size of PiP images, and PiP zoom. Change PiP mode (triple / triple gap / single fixed / single direct / single scan) and scan time.

```

HOTMOUSE
Channel: 1 →2  3  4
Mode:    full  quad →PiP
        win1 win2 win3 win4

single:  fixed  direct
        scan
triple: →gap   no gap
        tile

PiP zoom:      Yes →No
PiP offset:    ◀◀ 0% ▶▶
PiP size:      ◀ 15% ▶
CLOSE                HELP

```

**Triple gap:** PiP images are displayed with a gap in place of the active channel.

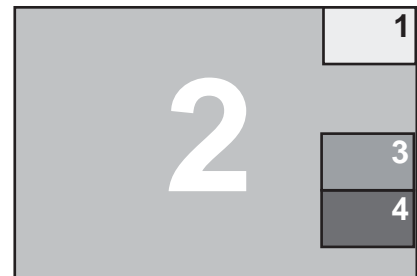

```

HOTMOUSE
Channel: 1 →2  3  4
Mode:    full  quad →PiP
        win1 win2 win3 win4

single:  fixed  direct
        scan
triple:  gap    →no gap
        tile

PiP zoom:      Yes →No
PiP offset:    ◀◀ 0% ▶▶
PiP size:      ◀ 15% ▶
CLOSE                HELP

```

**Triple no gap:** PiP images are displayed without a gap.

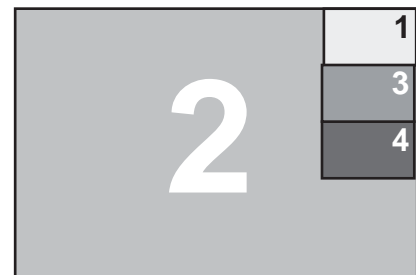

```

HOTMOUSE
Channel: 1 →2  3  4
Mode:    full  quad →PiP
        win1 win2 win3 win4

single:  fixed  direct
        scan
triple:  gap    no gap
        →tile

PiP zoom:      Yes →No
PiP offset:    ◀◀ 0% ▶▶
PiP size:      ◀ 15% ▶
CLOSE                HELP

```

**Triple tile:** The size of the main image and the PiP images is optimized so that the main image and the PiP images are shown as large as possible without overlapping.

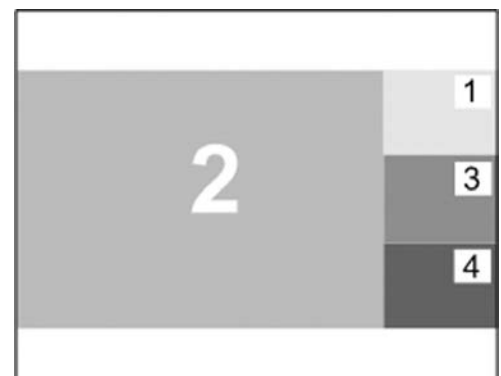

## Hotmouse Menu - MODES

### Hotmouse Menu – PIP MODE (continued)

```

HOTMOUSE
Channel: 1 →2  3  4
Mode:    full  quad →PiP
         win1 win2 win3 win4

single: →fixed  direct

HOTMOUSE
Channel: 1 →2  3  4
Mode:    full  quad →PiP
         win1 win2 win3 win4

single:  fixed →direct
         scan
triple:  gap    no gap
         tile

PiP zoom:      Yes →No
PiP offset:    <<< 0% >>>
PiP size:      < 15% >
CLOSE          HELP
    
```

**Single fixed:** One selected PiP image is permanently displayed.

**Single direct:** Press the front panel buttons 1, 2, 3, or 4 to directly select the PiP channel you want.



```

HOTMOUSE
Channel: 1 →2  3  4
Mode:    full  quad →PiP
         win1 win2 win3 win4

single:  fixed  direct
         →scan
triple:  gap    no gap
         tile

PiP zoom:      Yes →No
PiP offset:    <<< 0% >>>
PiP size:      < 15% >
CLOSE          HELP
    
```

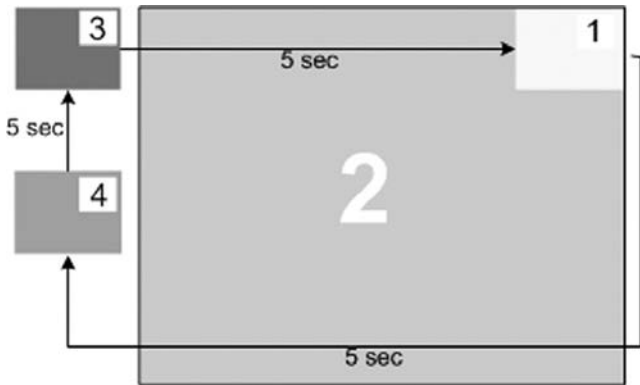

**Single scan:** Cycles through the PiP images at a set interval.

### Hotmouse Menu – Win Mode

Use the section "Mode" in the hotmouse menu in WIN mode to save the position of your channel windows. Four different configuration sets can be saved under win1, win2, win3 or win4.

1. Enter Win Mode
2. Position and/or resize your channel windows as desired.
3. Activate the hotmouse menu.
4. Select one of the win slots
5. Click "Save" at the bottom of the hotmouse menu

```

HOTMOUSE
Channel: →1  2  3  4
Mode:    full  quad  PiP
         →win1 win2 win3 win4
          transparent

Position:  hori <<< 240 >>>
           vert <<< 135 >>>
Size:      hori <<< 960 >>>
           vert <<< 540 >>>
 Aspect ratio
           ▲UP          ▼DOWN

CLOSE      SAVE      HELP
    
```

**SERVICE INFORMATION****MAINTENANCE AND REPAIR**

SPLITMUX does not contain any user-serviceable parts. Please report any malfunction or deviation from the functionality described in this manual during operation to NTI's Technical Support Department.

If we cannot solve your problem by phone and find that the fault is due to the unit, we will repair your unit free of charge during our warranty period. Please pack the device carefully, if possible in its original packaging, and send it to:

**Network Technologies Inc  
1275 Danner Drive  
Aurora, Ohio 44202  
USA**

**TECHNICAL SUPPORT**

If you cannot identify the cause of a problem, please contact NTI, Technical Support. Call telephone number below to obtain Return Authorization number before returning this product to NTI.

**Telephone**                                **330-562-7070 or 1-800-RGB-TECH (1-800-742-8324)**  
**Mondays through Fridays**        **08:00 AM to 5:00 PM (EST)**



**FCC DECLARATION****FEDERAL COMMUNICATIONS COMMISSION  
AND  
INDUSTRY CANADA  
RADIO FREQUENCY INTERFERENCE STATEMENTS**

This equipment generates, uses, and can radiate radio-frequency energy, and if not installed and used properly, that is, in strict accordance with the manufacturer's instructions, may cause interference to radio communication. It has been tested and found to comply with the limits for a Class A computing device in accordance with the specifications in Subpart B of Part 15 of FCC rules, which are designed to provide reasonable protection against such interference when the equipment is operated in a commercial environment. Operation of this equipment in a residential area is likely to cause interference, in which case the user at his own expense will be required to take whatever measures may be necessary to correct the interference. Changes or modifications not expressly approved by the party responsible for compliance could void the user's authority to operate the equipment.

This digital apparatus does not exceed the Class A limits for radio noise emission from digital apparatus set out in the Radio Interference Regulation of Industry Canada.

Le présent appareil numérique n'émet pas de bruits radioélectriques dépassant les limites applicables aux appareils numériques de la classe A prescrites dans le Règlement sur le brouillage radioélectrique publié par Industrie Canada.

**KEYBOARD COMMANDS**

SPLITMUX supports two types of hotkey: "multiple keys" and "double click".

By default, SPLITMUX is set to "multiple keys".

Use the OSD menu to choose the hotkey type and keys (see page 14).





**Multiple keys:** Press multiple keys plus command key.

**COMMAND** = Hotkey  and  together



The following hotkeys are available for selection:



By Default: **HOTKEY**  =  + 

Further examples:  =  +  + 

 =  + 

 = 

**Double click key:** Double click one key (=hotkey) and immediately press the command key within 2 seconds.

**COMMAND** = Hotkey  and  in sequence

As double click hotkey you can choose one of the following keys:



Examples: **HOTKEY**  =  

 =  







**Note:**

In command mode (hotkey is activated) LED flashing on the keyboard.  
In double click hotkey mode, pressing an invalid key leaves the command mode.

While OSD is open hotkey = 

## KEYBOARD COMMANDS

### Selecting display mode









	+		<b>Quad mode</b>
	+		<b>Fullscreen mode</b>
	+		<b>PiP mode</b>
	+		<b>Win mode</b>

### Selecting active channel in Fullscreen / Quad / PiP / Win mode

	+		<b>Computer 1</b>
	+		<b>Computer 2</b>
	+		<b>Computer 3</b>
	+		<b>Computer 4</b>

You can also use hotkey and the arrow keys to switch the active channel. In Quad and Win mode, you can select the channel on the right using the 1, 2, 3, or 4 keys on the numeric keypad. Switch the active channel with hotkey and the arrow keys. In PiP mode, the active channel automatically is displayed as full image.

### Open USB device switch menu

	+		<b>Open USB device/port 1 switch menu</b>
	+		<b>Open USB device/port 2 switch menu</b>
	+		<b>Open USB device/port 3 switch menu</b>
	+		<b>Open USB device/port 4 switch menu</b>

## KEYBOARD COMMANDS

### Other commands

<b>HK</b> + <b>O</b>	<b>Open OSD</b>
<b>HK</b> + <b>U</b>	<b>Directly open OSD USB Device 1-4</b>
<b>HK</b> + <b>V</b>	<b>Safe output mode</b>
<b>HK</b> + <b>I</b>	<b>Directly open OSD PiP menu</b> (In the background display mode switches to PiP as long as menu is open)
<b>HK</b> + <b>M</b>	<b>Open/Close the Hotmouse</b>
<b>HK</b> + <b>+/-</b>	<b>Adjust volume menu</b>

### Hotkeys for Win mode

<b>HK</b> + <b>S</b>	<b>Save current win mode to eeprom.</b>
<b>HK</b> + <b>R</b>	<b>Restore current win mode from eeprom and loose all changes.</b>
<b>HK</b> + <b>T</b>	<b>Toggle transparent status of current win mode.</b>
<b>HK</b> + <b>Z</b>	<b>Undo up to ten previous actions.</b>
<b>HK</b> + <b>Y</b>	<b>Redo up to ten previous actions</b>
<b>HK</b> + <b>W</b> + <b>1,2,3,4</b>	<b>Select Win mode</b>

## DEVICE CONFIGURATION PROGRAM

### Installation of Device Configuration Program (CONFDEV)

The Device Configuration Program allows you to remotely operate the OSD of SPLITMUX on an external Windows computer via serial connection.

To install the device configuration software CONFDEV, you need

- A Windows computer with a free USB or RS232 COM-port
- Your SPLITMUX
- The DCP Support.zip file from our website containing the **confdev.exe** program
- The enclosed "serial cable" (RJ45-DB9 adaptor + RJ45 CAT5 cable)

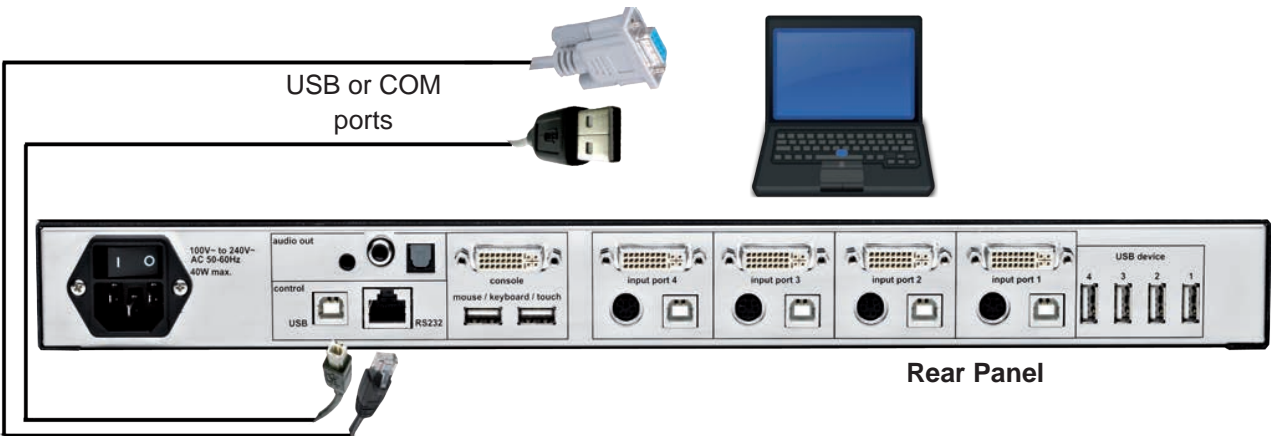

Use the serial cable to connect the COM port of the Windows computer with the serial port of your SPLITMUX.

Start the **confdev.exe** program. The Device Configuration Program (CONFDEV) window opens:



Click to open the OSD (device configuration) remotely.  
Click to change settings (Eg. COM port)

## DEVICE CONFIGURATION PROGRAM

### Settings

Click the "device configuration" button  to open the SETTINGS window. It allows you to set the font size for the OSD window, log parameters, and the COM port SPLITMUX is connected to.

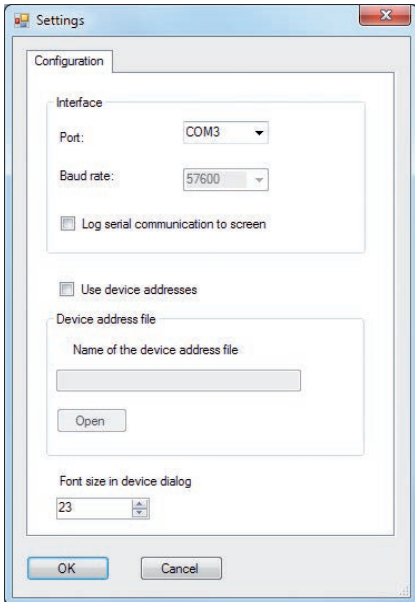

### Remote OSD operation

Click the green arrow  to open the On Screen Display (OSD) of SPLITMUX remotely on your external Windows computer.

Now, the main OSD menu is open and ready for navigation.

### Navigation

Use arrow keys on the keyboard of your remote Windows computer to navigate to the desired line in the OSD menu and confirm by pressing ENTER.

Use the ESC key to return to the previous menu.

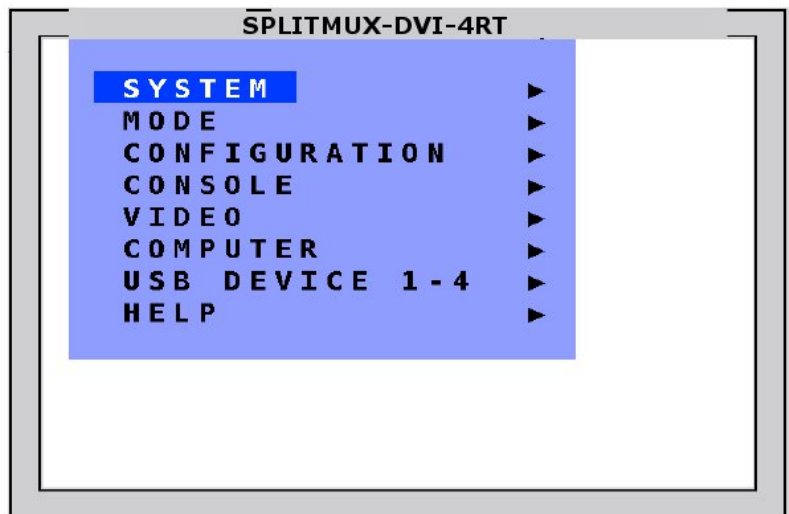

**DEVICE CONFIGURATION PROGRAM - UPLOADING A BACKGROUND IMAGE****UPLOADING A BACKGROUND IMAGE**

A background image can be uploaded to the SPLITMUX and will be displayed behind windows when in Win Mode. To upload an image to the SPLITMUX, use the ConfDev menu DEVICE > LOAD BACKGROUND IMAGE.

**IMPORTANT: Only 256 color bitmaps are supported for background images. The file used should have a maximum size of 2 MB. The maximum resolution will be that of the monitor connected.**

If an image of another format needs to be used, it must first be converted into a bitmap. There are free tools available like Gimp or Paint.NET to do this conversion. MS paint available in Windows also supports this conversion. Due to the limited color count in the bitmap format, the quality of the image may be reduced.

For downloading a compression algorithm is used. If the image cannot be compressed well, the download can take up to 30 minutes.

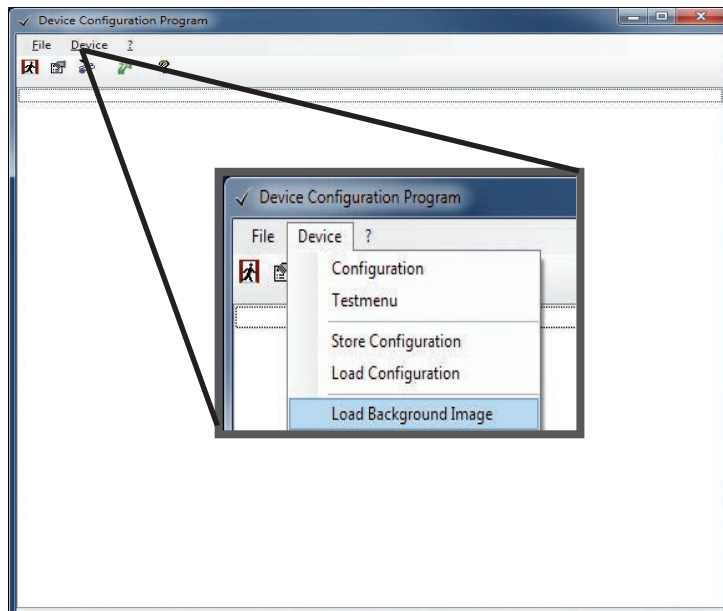

A 256 color bitmap is uploaded from the user PC to SPLITMUX using the ConfDev utility.



**DEVICE CONFIGURATION PROGRAM - STORING AND LOADING A CONFIGURATION**

**STORING A CONFIGURATION**

ConfDev can also be used to store device configurations to a file on your PC. Open the ConfDev menu **DEVICE > STORE CONFIGURATION**. The Save As dialog will appear and you can save the configuration to the desired location.

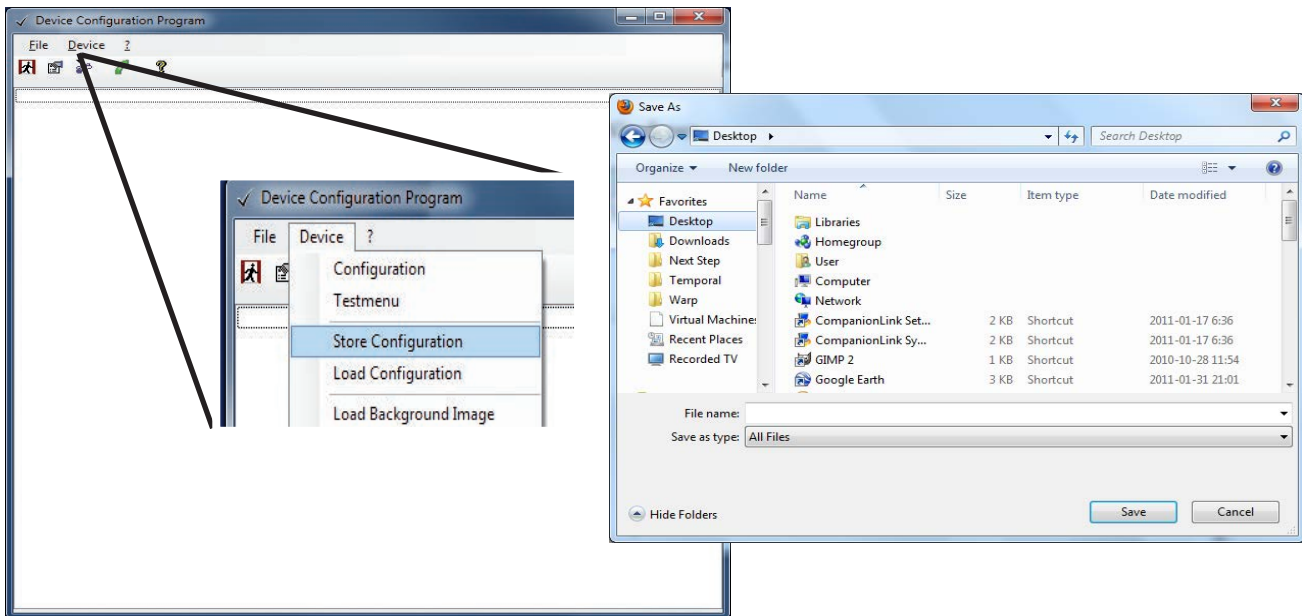

**LOADING A CONFIGURATION**

ConfDev can be used to load device configurations from a file on your PC. Open the ConfDev menu **DEVICE > LOAD CONFIGURATION**. The Open dialog will appear from which you can select the configuration file to be loaded.

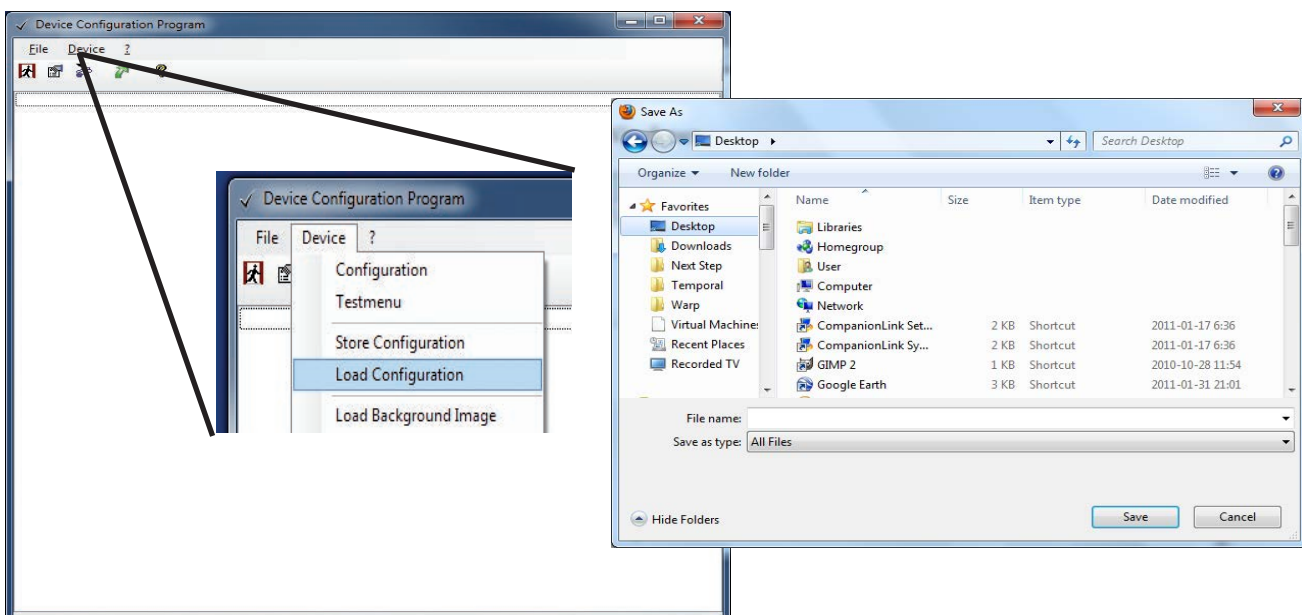



## FIRMWARE UPDATE

### Update firmware of SPLITMUX

To execute a firmware update, you need:

- a computer with serial or USB port
- the enclosed "serial cable" (RJ45-DB9 adaptor + RJ45 CAT5 cable) or a USB cable (USB-A/USB-B)
- the current executable firmware file

1a. Use the serial cable to connect the COM port of your computer to the RS232 port on SPLITMUX.

OR

1b. Use the USB cable to connect the USB port of your computer to the USB port on SPLITMUX.

**Note: the virtual com port USB driver can be downloaded from the Future Technology Devices International Ltd. website at [www.ftdichip.com/Drivers/VCP.htm](http://www.ftdichip.com/Drivers/VCP.htm)**

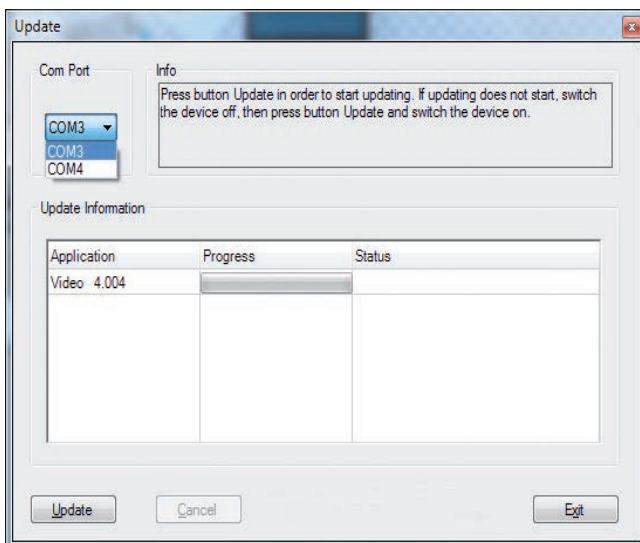
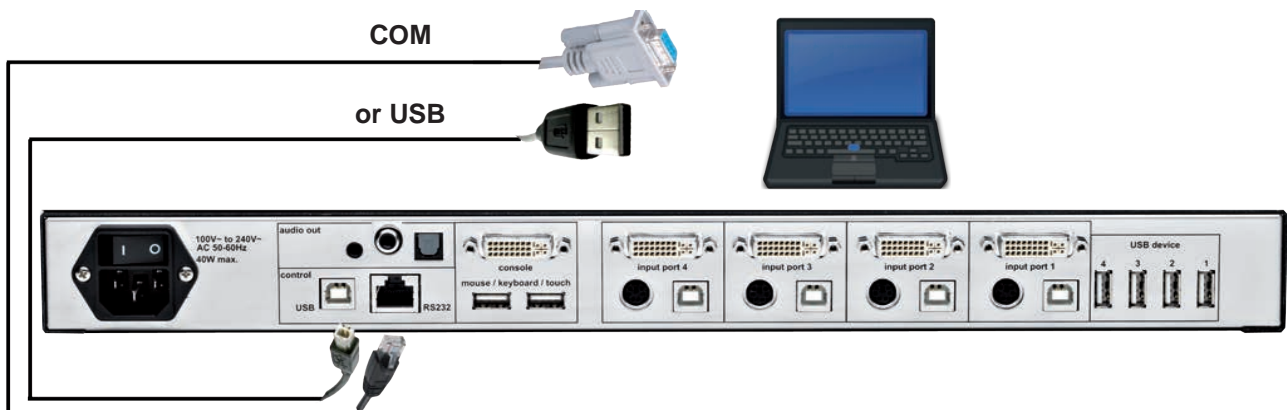

2. Start the executable firmware file.

3. Set the desired COM port

4. Press "Update".

LEDs 1-4 on the front panel of SPLITMUX flash (blue) during the update.

**FIRMWARE UPDATE (CONTINUED)**

**Update firmware of SPLITMUX (continued)**

Additionally, the upgrade process is indicated by an OSD window on your remote computer.

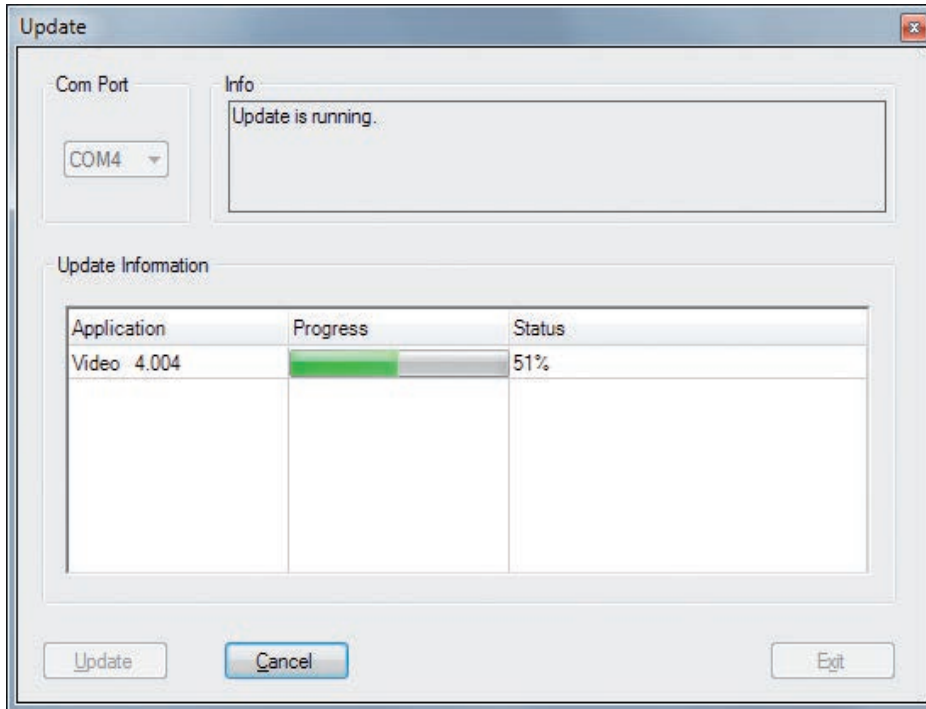

After successful update, SPLITMUX restarts without changing configuration.

**SERIAL CABLE**

For serial remote control, SPLITMUX requires a special adaptor to connect a CAT5 cable to the serial RJ45 port at the rear panel of SPLITMUX.

This adaptor is connected to your external serial control device (e.g. computer). To the adaptor any CAT5 cable can be connected. The CAT5 cable again is connected to the RJ45 port of SPLITMUX. The adaptor (plus a standard CAT5 cable (in green)) is supplied with SPLITMUX.

Serial cable = NTI adaptor + standard CAT5 cable

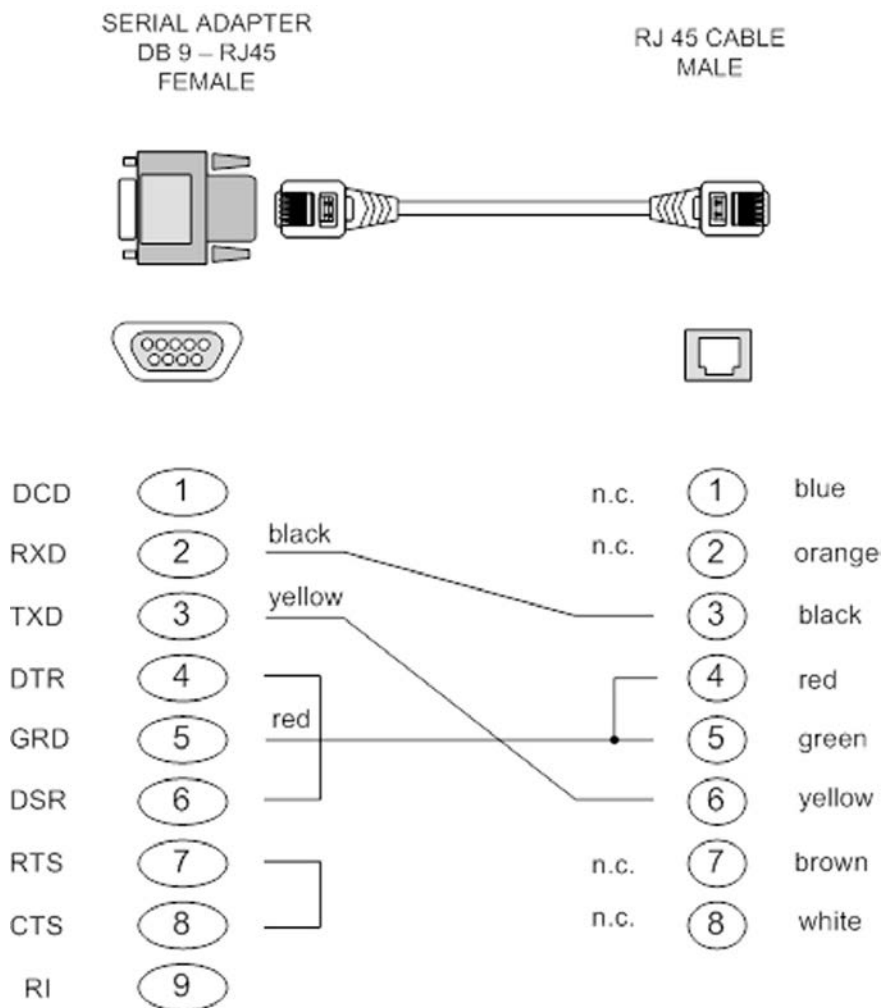

## DCP-XML REMOTE CONTROL

DCP-XML permits remote control of SPLITMUX by a computer or other devices using the RS-232 serial port of SPLITMUX. To connect to this port, use the "serial cable" (NTI RJ45-DB9 adaptor + standard RJ45 CAT5 cable).

DCP is an XML-based protocol. (Device Control Protocol). Using DCP, all important settings of SPLITMUX can be queried and changed.

A general description of XML can be found at <http://www.w3.org/XML/>

The XML scheme for DCP can be found in the DCP Support.zip file, under the name "dcp.xsd".

For a detailed description on how to use DCP-XML with SPLITMUX please see the "DCP-XML Manual" found on our website.

### DCP Modes

DCP has two modes of operation:

#### 1. Control

This mode is intended for direct control of a SPLITMUX, for example using a computer.

#### 2. Synchronize (not used as of this publishing)

This mode is used to synchronize multiple, linked devices.

In Synchronize mode, SPLITMUX sends all settings changes as DCP messages.

Thus, a chain of linked SPLITMUX can be controlled synchronously.

---

**SUPPORTED TOUCH SCREEN CONTROLLER**

SPLITMUX supports **USB touch screens** having built in one of the following controllers:

**Tyco ELO Touch System:**

- **AccuTouch** Five-Wire Resistive Touch Technology

includes models 1215L, 1229L, 1515L, 1522L, 1528L Medical, 1529L, 1537L, 1715L, 1729L, 1739L, 1915L, 1928L, 1928L Medical, 1939L, 2020L

- **IntelliTouch** Surface Wave Touch Technology

elo 2701 Controller Series (IntelliTouch, SecureTouch)

- **CarrollTouch** Infrared Touch Technology

(not supported: Acoustic Pulse Recognition (APR))

**TSharc:**

**TSharc Octopus** Controller

widely used, including in touch screens manufactured by 3M, Microtouch, TrollTouch, The Bergquist Company

**3M MicroTouch:**

- **MicroTouch™ EX II** (new release delivered since 2009 with support of HID)

- **MicroTouch™ DST**, only restrict: (first calibrate it at computer, then same procedure but while connected at SPLITMUX; only left mouse key support, right mouse key has no function). E.g. integrated at display NEC Multeos 32" und 40" LCD with touch option.

**ET&T Technology:**

**ETouch IR™** infra red touch screen, aluminium frame, 26" up to 65"

**eGalaxy eMPIA Technology Inc. (EETI):**

**S5000UEGG**; 4/5-Wire Resistive Touch Technology; USB;

**Note:**

New multitouch screen systems are compatible with the newly defined digitizer touch screen interface. Generally these can be used.

**SUPPORTED VIDEO INPUT**

**VIDEO INPUT (Display Video Formats)**

Mode	Resolution	Sync polarity H/V	Refresh rate		Set in EDID	VESA / CEA Standard
			analog Hz	digital* Hz		
CGA	640x350	+/-	85	85		DMT
CGA	640x400	-/+	85	85		DMT
EGA	720x400	+/+	70	70	x	CVT
EGA	720x400	-/+	85	85		DMT
VGA	640x480	-/-	60	22 - 60	x	DMT
VGA	640x480	-/-	72	72	x	DMT
VGA	640x480	-/-	75	75	x	DMT
VGA	640x480	-/-	85	85	x	DMT
SVGA	800x600	+/+	56	22 - 56	x	DMT
SVGA	800x600	+/+	60	60	x	DMT
SVGA	800x600	+/+	72	72	x	DMT
SVGA	800x600	+/+	75	75	x	DMT
SVGA	800x600	+/+	85	85 - 180	x	DMT
XGA	1024x768	-/+	50	22- 50		CVT
XGA	1024x768	-/-	60	60	x	DMT
XGA	1024x768	-/-	70	70	x	DMT
XGA	1024x768	+/+	75	75	x	DMT
XGA	1024x768	+/+	85	85	x	DMT
XGA/B	1152x864	+/+	75	75	x	DMT
SUN	1152x900	+/+	66	66		CVT
HDTVp	1280x720	+/+	50	22 - 50		CEA-861-E
HDTVp	1280x720	+/+	60	60		CEA-861-E
WXGA	1280x768	-/+	60	60		DMT
UWXGA	1280x960	+/+	60	60		DMT
UWXGA	1280x960	+/+	85	85		DMT
SXGA	1280x1024	g	50	50		CVT
SXGA	1280x1024	+/+	60	60	x	DMT
SXGA	1280x1024	g	72	72		CVT
SXGA	1280x1024	+/+	75	75	x	DMT
SXGA	1280x1024	+/+	85	85	x	DMT
WXGA	1360x768	+/+	60	22 - 60		DMT
SXGA+	1400x1050	-/+	50	22 - 50		CVT
SXGA+	1400x1050	-/+	60	60		DMT
SGI	1600x1024	+/+	60	60		CVT
UXGA	1600x1200	+/+	50	50		CVT
UXGA	1600x1200	+/+	60	60	x	DMT
UXGAr	1600x1200	+/+	50	50		CVT
UXGAr	1600x1200	+/+	60	60		CVT
WSXGA	1680x1050	-/+	60	60		DMT
HDTVp	1920x1080	+/+	---	22 - 24		CEA-861-E
HDTVp	1920x1080	+/+	50	50		CEA-861-E
HDTVp	1920x1080	+/+	60	60	x	CEA-861-E
WUXGAr	1920x1200	+/+	50	22 - 50		CVT
WUXGAr	1920x1200	+/+	60	60	x	DMT

**Note:**

\* digital: **all** video formats up to 162 MHz pixel clock following DMT, CVT or GTF standard timings are supported. Within this range **ANY** digital resolution is supported.  
Analog input may not be detected correctly. See page 47 EDID/DDC.

## SUPPORTED VIDEO OUTPUT

### VIDEO OUTPUT (Display Video Formats)

The table lists all video formats supported by SPLITMUX at the output port.

Mode	Horizontal	Vertical	Hz
VGA	640	480	60
VGA	640	480	75
VGA	640	480	85
SVGA	800	600	60
SVGA	800	600	75
SVGA	800	600	85
XGA	1024	768	50
XGA	1024	768	60
XGA	1024	768	70
XGA	1024	768	75
XGA	1024	768	85
SXGA	1280	1024	50
SXGA	1280	1024	60
SXGA	1280	1024	75
SXGA+	1400	1050	50
SXGA+	1400	1050	60
UXGA	1600	1200	50
UXGA	1600	1200	60
UXGAr	1600	1200	50
UXGAr	1600	1200	60
XGA/B	1152	864	75
UWXGA	1280	960	60
UWXGA	1280	960	85
SUN	1152	900	66
WXGA	1280	768	60
WXGA	1366	768	60
WSXGA	1680	1050	60
WUXGAr	1920	1200	40
WUXGAr	1920	1200	50
WUXGAr	1920	1200	60
HDTVp	1280	720	50
HDTVp	1920	1080	24
HDTVp	1920	1080	50
HDTVp	1920	1080	60

**Note:**

When set to auto (by default) SPLITMUX reads the EDID of the monitor connected and automatically supports its resolution.

## CASCADING

### CASCADING multiple SPLITMUX units - more than 4 video sources on a single display

SPLITMUX can be cascaded in order to display more than 4 video sources simultaneously on a single display.

In this master-slave-system, any SPLITMUX can be used as master or slave. It is the same hardware. One SPLITMUX is used as master unit. The console that has a keyboard, mouse and display or touchscreen is connected to the output of the master unit. A slave SPLITMUX can be connected to each input of the master unit. In this way, each quadrant on the display can be split in four more quadrants.

Example: In a setup with one master and four slave SPLITMUX a total of 16 video sources can be displayed simultaneously on a single console.

#### All display modes:

Display modes (Fullscreen, Quad, PiP, Win) of slaves and master can individually be set, combined, and switched, e.g. the master unit could be set to Quad mode, while the first slave is set to PiP, the second slave to Fullscreen, the third slave to Quad and the fourth slave to Win mode. Any combination is possible.

#### Keyboard and mouse operation:

Keyboard and mouse can be activated on any of the up to 16 computers connected to operate these.

#### Hotkeys for switching:

Use hotkeys to quickly activate any of the e.g. 16 channels or to switch the display mode of any of the SPLITMUX units in the master-slave-system.

Different levels (master or slave) require different types of hotkeys.

For example, keep the hotkey default setting  $\text{HK1} = \text{Ctrl} + \text{Alt}$  for all slave SPLITMUX.

Just change the hotkey setting for the master SPLITMUX to e.g.

$\text{HK1} = \text{Ctrl} + \text{Win}$

See page 19 on how to change hotkeys.

Example:

In a cascaded SPLITMUX setup with one master, 4 slaves, and 16 computers connected you can activate keyboard and mouse of computer 16 by pressing the following hotkey combination:

**HK2 + 4** (to activate the channel 4 on the master level), **then HK1 + 4** (to activate the channel 4 on the slave SPLITMUX connected to port 4 of the master)

Example:

To change a display mode of e.g. the slave SPLITMUX connected to port 4 of the master SPLITMUX press the following hotkey combination:

**HK2 + 4** (to activate the channel 4 on the master level), **then HK1 + P** to switch from default Quad mode to PiP mode in this quadrant. The result is a screen split in four equal quadrants. All quadrants are split again in four equal quadrants (Quad mode), just the quadrant in the lower right corner (channel 4) is showing its four sources in PiP mode.

#### Note:

Use a programmable keyboard for comfortable switching of cascaded SPLITMUX. Behind a single key you can program a combination of hotkeys. By pressing a single key you can activate keyboard and mouse of one of e.g. 16 computers connected or the switch display mode of the master or any of the four slave SPLITMUX.



Knowledgebase Entries

Legend:

- <x> denotes a keyboard key
- <x> + <y> = press keys simultaneously
- <x> - <y> = press keys consecutively

**“If multiple SPLITMUX-DVI-4RT Units are Cascaded, can you manually size the individual screens and save your settings as a preset?”**

1, Configure the Master hot key setting to activate with a hotkey different than the default (i.e. change to <Ctrl> + <Win>). (manual page 19).

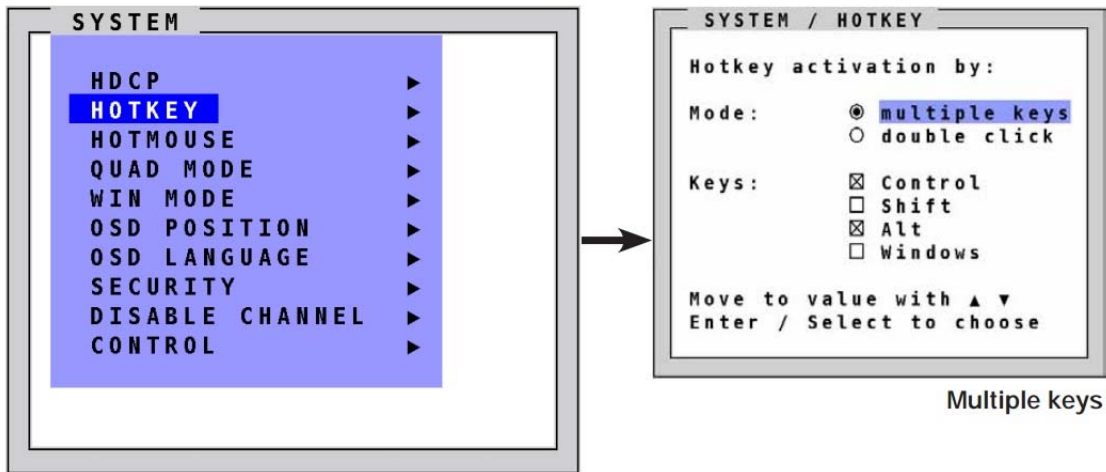

2. Keep the default hot key as <Ctrl> + <Alt> for each Slave unit.

You now want to set the WIN mode for the slaves to display the channels just the way you want to view them, and save that configuration as presets Win1, Win2, Win3 or Win4. (manual page 37)

3. Enter <Ctrl> + <Win> - <1> (if the slave you want to configure is connected to Channel 1 of the master) Your keystrokes will now control the slave on channel 1.
4. Enter <Ctrl> + <Alt> - <O> (that’s the letter “O”, not a zero). This will open the OSD menu on the slave switch.
5. Navigate to the configuration of the Win Mode. Select **Mode- Current-** and **Win1** under **Mode** (see images on page 37).

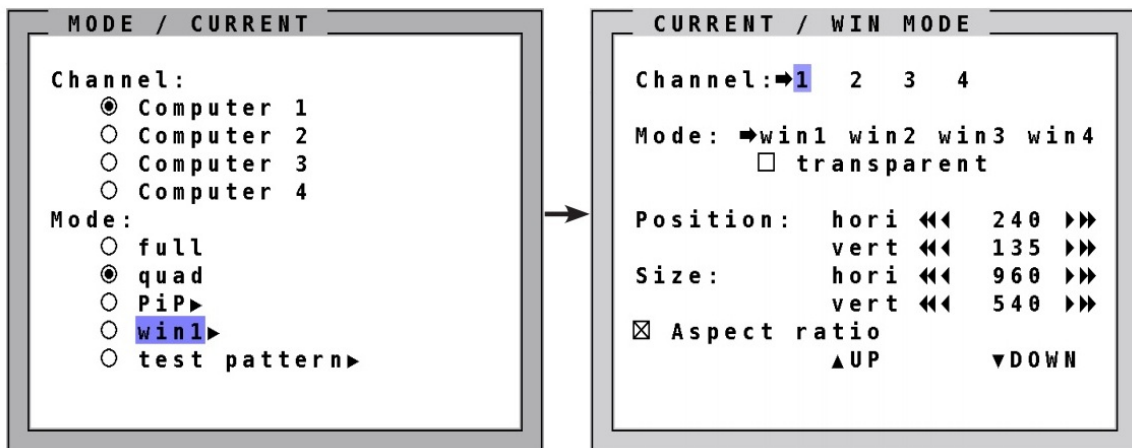

6. Configure the displays on each channel to appear as desired while "Win1" is selected, changing the Position, Size, and Aspect ratio as needed. The unit will auto save as you change each parameter. Be sure to adjust these settings for each channel while Win1 is still selected.

**Tip: You can also use the Hotmouse Menu to configure the presets (manual page 82).**

7. Repeat for presets Win2, Win3 and Win4 as desired.

Now, anytime you select that channel and place that channel in Win mode (<Ctrl> + <W>), it will start with your preset configuration of display appearance.

**Tip: While in Win mode, Enter <Ctrl> + <W> + <2> to switch from preset Win1 to preset Win 2.**

## "If multiple SPLITMUX-DVI-4RT Units are Cascaded, can you make any one of the inputs full screen?"

1, Configure the Master hot key setting to activate with a hotkey different than the default (i.e. change to <Ctrl> + <Win>). (manual page 19)

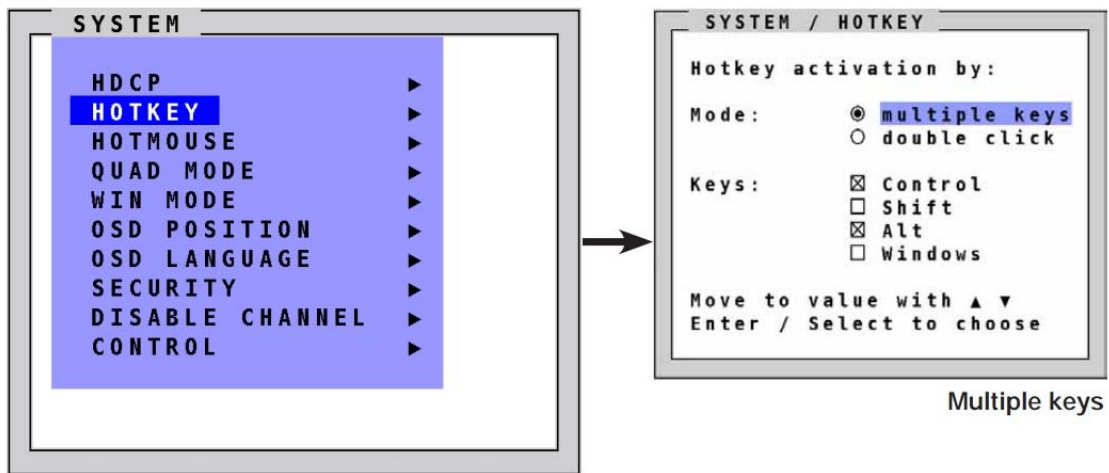

2. Keep the default hot key as <Ctrl> + <Alt> for each Slave unit.

3. Enter <Ctrl> + <Win> - <1> (if the slave with the display you want at full screen is connected to Channel 1 of the master) This will connect directly to Channel 1 of the Master.

4. Enter <Ctrl> + <Alt> - <1> (if the display you want at full screen is connected to Channel 1 of the slave) This will connect directly to Channel 1 of the Slave connected to Channel 1 of the Master.

5. Enter <Ctrl> + <Alt> - <F>. This will put the video source on Channel 1 of the Slave at full screen for the Slave.

6. Enter <Ctrl> + <Win> - <F>. This will put the video source on Channel 1 of the Slave at full screen for the Master.

## TROUBLE SHOOTING

### **PROBLEM: XC Mini computer reboots when connected to SPLITMUX**

**SOLUTION: Perform these settings changes to solve a re-boot issue with certain XC Mini computers**

- 1) Connect the Monitor that will be used to “Console” port of SPLITMUX unit.
- 2) Connect the XC Mini PC to “Input Port 1” of SPLITMUX unit.  
Connect computer to SPLITMUX unit using a DVI-to-DVI cable or DP-to-DVI cable.
- 3) Enter/ open the OSD menu by pressing the **PiP** and **Quad** buttons simultaneously.
- 4) Press **Down-arrow** button to highlight “Computer”, then press **select** button
- 5) Press **Down-arrow** button to highlight “EDID/DDC”, then press **select** button
- 6) Press **select** button to select Channel 1,
- 7) Press **Down-arrow** button to highlight “Same As Display EDID”.
- 8) Press **select** button (“Successful” should be displayed at bottom of window and the name for Channel 1 should indicate the monitor name.)

**Note: Settings changes are live, so the computer connected to Input Port1 will boot fully now.**

- 9) Press **exit** button to go back to the Computer/ EDID screen of OSD menu,
- 10) Repeat steps 6-9 until for each input port until all ports have been changed.
- 11) Press **exit** button a few times until the OSD menu is gone and the unit is in normal mode.
- 12) Turn ON the computers (if not already ON). The XC mini Computer should boot normally.

### **PROBLEM: No Video Output**

**SOLUTION: Perform these settings changes to solve a “No video output” issue using a Digital Video source**

- 1) Connect computer to SPLITMUX unit using a DP-to-VGA or DVI-to-VGA cable/ adapter,
- 2) Enter/ open the OSD menu, by pressing the **PiP** and **Quad** buttons simultaneously.
- 3) Press **Down-arrow** button to highlight “Computer”, then press **select** button
- 4) Press **Down-arrow** button to highlight “EDID/DDC”, then press **select** button
- 5) Press **select** button to select Channel 1 (or **down-arrow** to specific port with DP source as input)
- 6) Press **Down-arrow** to “analog” then press **select** button
- 7) Press **Down-arrow** to “Write” –OR- if all inputs are similar, then **Down-arrow** to “Write to All Inputs” then press the **select** button.
- 8) Press **exit** button a few times until the OSD menu is gone the unit is in normal mode.
- 9) Turn ON the computers (if not already ON). The sources video should be displayed.

**PROBLEM: No Video using a 4K monitor**

**SOLUTION: Change output resolution of unit**

***SETUP: Use the confdev utility via RS232 port and manually choose 1920x1200 as output resolution, or connect a different monitor to the unit and set output resolution via OSD menu as follows:***

- 1) Enter/open the OSD menu, by pressing the PiP and Quad buttons simultaneously.
- 2) Press Down-arrow button to highlight "Console", then press select button
- 3) Press select to enter the Video Output menu
- 4) Press select, "Auto" should now be highlighted.
- 5) Press Down-arrow until desired resolution is highlighted and press select button.
  - a. If the monitor does not accept the chosen resolution a message such as "Invalid format" will be displayed by the monitor. Wait several seconds for the menu reappear and press up- or down-arrow buttons to choose another resolution.
  - b. If the monitor accepts the selected resolution, a screen will pop up noting that a new resolution was chosen. Press the select button to accept the resolution change.
- 6) Press Exit button until OSD menu is gone and the unit is in normal mode.
- 7) Connect the 4K monitor. Video should now be displayed.

---

**BOX CONTENTS**

Please use the list below to verify that all parts have been delivered.

The following components are included:

- 1- SPLITMUX-DVI-4RT
- 1- 19" Rackmount Kit
- 1- Country specific power cable
- 1- Adapter DVI-I male-to-VGA (15HD) female
- 1- 7 Inch Y-cable PS/2 Keyboard and mouse to USB type A male
- 4- USB Type A male to USB Type B male cable- length 2.0 meters
- 2- 15HD Male VGA to DVI-I male cable- length 2.0 meters
- 2- DVI-D male to DVI-D male dual link cables- length 2.0 meters
- 1- DB9 female to RJ45 Serial Adapter
- 1- CAT5 patch cable- 6 feet long
- 1- 6 pack of tie-wraps
- 1- URL Slip with path to product manual



[www.networktechinc.com](http://www.networktechinc.com)