



**NETWORK
TECHNOLOGIES
INC**

1275 Danner Dr Tel:330-562-7070
Aurora, OH 44202 Fax:330-562-1999
www.networktechinc.com

SPLITMUX® Series

SPLITMUX-4K18GB-4

SPLITMUX-USB4K18GB-4

4K 18Gbps Quad Screen Splitter/Multiviewer Installation and Operation Manual



SPLITMUX-4K18GB-4



TRADEMARK

SPLITMUX and the NTI logo are registered trademarks of Network Technologies Inc in the U.S. and other countries. All other brand names and trademarks or registered trademarks are the property of their respective owners.

COPYRIGHT

Copyright © 2014-2024 by Network Technologies Inc. All rights reserved. No part of this publication may be reproduced, stored in a retrieval system, or transmitted, in any form or by any means, electronic, mechanical, photocopying, recording, or otherwise, without the prior written consent of Network Technologies Inc, 1275 Danner Drive, Aurora, Ohio 44202.

CHANGES

The material in this guide is for information only and is subject to change without notice. Network Technologies Inc reserves the right to make changes in the product design without reservation and without notification to its users.

FIRMWARE VERSION

2.0

WARRANTY INFORMATION

The warranty period on this product (parts and labor) is two (2) years from the date of purchase. Please contact Network Technologies Inc at **(800) 742-8324** (800-RGB-TECH) or **(330) 562-7070** or visit our website at <http://www.networktechinc.com> for information regarding repairs and/or returns. A return authorization number is required for all repairs/returns.

TABLE OF CONTENTS

Introduction.....	1
Supported Web Browsers	2
Materials.....	2
Connectors and LEDs	3
Mounting.....	5
Installation	7
Terminal Connection for RS232	9
Ethernet Connection for Remote User Control.....	9
Power ON.....	10
Control Methods	11
Front Panel Buttons	11
Standard Mode	11
OSD Mode	13
Reset Resolution	14
Command Mode	14
Hot Mouse Mode	14
Device Discovery Tool.....	15
How to Use the Device Discovery Tool	15
Use and Operation via Web Interface	16
Log In and Enter Password	16
Administration-System.....	18
Administration-Network.....	20
Administration- Input Settings.....	21
Administration- Output Settings	22
Audio Level and Gain	23
Audio Mode Settings	23
Administration-Mode Settings.....	24
Single PIP Mode.....	27
Double PIP Mode	27
Triple PIP Mode.....	27
Administration- Custom Settings	28
Preset Layouts and Display Preview.....	29
Alignment Tools.....	29
Individual Channel Settings.....	30
Enable/Disable Channels	30
Save/Restore Layouts	31
Cascade Settings.....	32
Administration-User Config.....	34
Administration- Firmware.....	35
Administration- System Information.....	36
Logout.....	36
Support	37
Reboot	37
Command Line Interface.....	38
RS232 Control	38
Baud Rate.....	38
RS232 Command Protocol.....	39

Telnet Control	40
Using The Text Menu	41
Text Menu Navigation.....	41
Current Mode.....	42
System Configuration	43
Network Configuration	45
User Configuration.....	47
Input Configuration	49
Output Configuration.....	50
Mode Configuration	52
Load/Save Layout.....	56
System Information.....	57
Using OSD.....	58
Navigating the OSD menus	58
Navigating OSD menu via Keyboard	59
System Configuration	60
Network Configuration	61
Input Configuration	63
Output Configuration.....	64
Mode Configuration	65
Load / Save Layout.....	69
System Information.....	70
Infrared Remote Control.....	71
Materials	71
Buttons.....	71
Operation	72
Changing Ports	72
Audio Control	72
Save and Recall.....	72
Multiple Multiviewer Control.....	72
Technical Specifications For IRT-UNV	73
Troubleshooting the IRT-UNV	73
Example of Cascaded Configuration.....	74
Specifications	77
Troubleshooting.....	78
Removing Lines	79
Index.....	81

TABLE OF FIGURES

Figure 1- Attach ear brackets to front corners.....	5
Figure 2- Assembled unit, ready to mount in rack.....	5
Figure 3- Remove cable tray (if applicable)	6
Figure 4- Video Source/Display Connections	7
Figure 5- Video Source\Display Connections- SPLITMUX-USB4K18GB-4	8
Figure 6- RS232 Terminal Connection.....	9
Figure 7- Ethernet connection.....	9
Figure 8- Power Switch and LED.....	10
Figure 9- Front Panel Button Functions	13
Figure 10- Device Discovery Tool.....	15
Figure 11- Login prompt to access web interface	16
Figure 12- Initial page- Administrator.....	17
Figure 13- Initial page- Non-Admin User.....	17
Figure 14- System Configuration	18
Figure 15- Network Configuration	20
Figure 16- Input Settings.....	21
Figure 17- Output Settings.....	22
Figure 18- Display with sound level indications	23
Figure 19- Mode Settings.....	24
Figure 20- Triple Screen Mode Settings	25
Figure 21- PIP Screen Mode Settings	26
Figure 22- Custom Screen Mode Settings	28
Figure 23- Pan and Crop Enabled	29
Figure 24- Cascading SPLITMUXs.....	32
Figure 25- Cascade Settings	32
Figure 26- User Configuration.....	34
Figure 27- Firmware Update	35
Figure 28- System Information page.....	36
Figure 29- Text Menu- Login screen.....	41
Figure 30- Text Menu-Main Menu.....	42
Figure 31- Text Menu-Current Mode Selection.....	42
Figure 32- Text Menu- System Configuration	43
Figure 33- Text Menu- Unit Settings	43
Figure 34- Text Menu- Serial Port Settings.....	44
Figure 35- Text Menu- OSD Screen Settings	44
Figure 36- Text Menu- Restore Default Settings.....	45
Figure 37- Text Menu- Network Configuration	45
Figure 38- Text Menu- IPv4 Network Settings	46
Figure 39- Text Menu-Server Settings	47
Figure 40- Text Menu- Users List	47
Figure 41- Text Menu- Account Settings.....	48
Figure 42- Text Menu- User Account Settings.....	48
Figure 43- Text Menu- Input Configuration	49
Figure 44- Text Menu- Output Configuration	50
Figure 45- Text Menu- Audio Output Configuration	51
Figure 46- Text Menu- Mode Settings Menu.....	52
Figure 47- Text Menu- Default Mode Configuration.....	52
Figure 48- Text Menu- Full Screen Mode Settings	53
Figure 49- Text Menu- Quad Mode Settings.....	53
Figure 50- Text Menu- PIP Mode Settings.....	54
Figure 51-Text Menu- Triple Screen Mode Settings	55

Figure 52- Text Menu- Custom Mode Settings 55

Figure 53- Text Menu- Load/Save Layout..... 56

Figure 54- Text Menu- System Information..... 57

Figure 55- Front Panel Button OSD Functions 58

Figure 56- The OSD Menu..... 58

Figure 57- OSD System Configuration..... 60

Figure 58- OSD Network Configuration 61

Figure 59- OSD IP Settings 62

Figure 60- OSD Server Settings 62

Figure 61- OSD Input Configuration 63

Figure 62- OSD Input Settings..... 63

Figure 63- OSD Output Settings..... 64

Figure 64- OSD Mode Settings..... 65

Figure 65- Default, Full Screen and Quad Screen Settings 66

Figure 66- PIP Screen Mode settings 67

Figure 67-Triple Mode Settings..... 68

Figure 68- OSD- Custom Screen Mode Settings 68

Figure 69- OSD- Load/Save Layout functions 69

Figure 70- Save or Load a Custom Layout 69

Figure 71- OSD- System Information Page 70

Figure 72- View of cascaded configuration from Master 74

Figure 73- View of cascaded configuration from Slave at IP 192.168.3.173..... 75

Figure 74- View of cascade configuration from Slave at IP 192.168.3.125..... 75

Figure 75- View of custom configuration of Slave at IP 192.168.3.183..... 76

Figure 76- Current output mode selection..... 76

Figure 77- Four channels, overlapping to remove lines 80

INTRODUCTION

The SPLITMUX® 4K 18Gbps Quad Screen Splitter/Multiviewer allows you to simultaneously display 4k Ultra High Definition video from four different computers or video sources on a single monitor providing resolutions up to 4096 x 2160.

Features:

- Quad, Picture-in-Picture, Full Screen, Triple and Custom display modes with configurable window transparency.
- Independent video-in-to-video-out resolution.
- Supports Ultra-HD input and output resolutions
 - Up to UHD(2160p), 4096x2160@60Hz HDMI 2.0 (4k/UHD real-time video).
- Connect digital video sources to the splitter and display images on a digital monitor.
- Output resolution and frame rate independent of input.
- Front panel pushbutton, a USB hot keyboard/mouse port (for navigating OSD, selecting and naming inputs, etc.), Ethernet (web server with GUI and Telnet), RS-232, and IR control (optional).
- Infinite number of levels of video cascading with web server GUI support .
- HDMI features supported:
 - Input: 24-, 30-, and 36-bit RGB, and YCbCr.
 - Output: 24-bit RGB.
 - Four-channel mixing stereo with 16-, 20-, or 24-bit uncompressed PCM audio.
 - Video bandwidth up to 594Mhz (5.94Gbps).
- Any DVI source or display can be connected by using the DVI-HD-xx-MM cable (not included).
 - Use DVIA-HD-CNVTR-LC or DVI-HD-CNVTR DVI + Audio to HDMI Converters to pass and independently switch audio signals to the multiviewer.
- HDCP V2.2 compliant
- On-screen display
- Fluid, real-time video performance with up to 60 frames per second (fps) in all four quadrants
- HDMI-embedded audio switching (four-channel stereo, non-mixing or one-channel stereo, mixing).
 - Switch audio independently of video from HDMI sources
- Control the multiviewer through the front panel buttons, on screen display (OSD), RS232 serial port, infrared remote control or Ethernet.
- Backup and restore multiviewer configuration.
- Supported output resolutions can be selected or set to auto detect.
- Cable management shelf and rackmounting ears included
 - Units can be mounted in a rack so that the front panel buttons are facing the front or back of the rack.
- USB KVM version:
 - The two attached USB device ports (for hot keyboard/mouse) double as inputs for human interface device emulation.
 - 2-port USB 2.0 high-speed transparent switch.

SUPPORTED WEB BROWSERS

Most modern web browsers should be supported. The following browsers have been tested:

- Microsoft Edge
- Mozilla FireFox 30.0 or higher
- Opera 12.02 or higher
- Google Chrome 9.0.5 or higher
- Safari 5.0 or higher for MAC and PC

MATERIALS

Materials supplied with SPLITMUX-(USB)4K18GB-4:

- NTI SPLITMUX-(USB)4K18GB-4 Multiviewer
- 120VAC or 240VAC at 50 or 60Hz-12VDC/8.3A AC Adapter (PS4626)
- Country-specific power cord
- CT6182 DB9 Female-to-RJ45 Female adapter
- CB7094 5 foot CAT5E-SF32-5-BLACK patch cable
- 2- MP5160 Rack Ears
- 8- HW5133 #6-32x1/4" Flat head Screws

Materials Included with SPLITMUX-(USB)4K18GB-4-2R (same as SPLITMUX-(USB)4K18GB-4 plus the following):

- 4- MP4829 Ear Brackets
- 2- MP5172 End Brackets (Ears)
- 1- MP4830 Cable Tray Connector
- 2- MP4828 Connector Plate
- 24- HW5133 #6-32x1/4" Flat head Screws
- 4- HW7097 #4-40x3/16" Pan head Screws

Additional materials may need to be ordered;

CAT5/5e/6 unshielded twisted-pair cable(s) terminated with RJ45 connectors wired straight thru- pin 1 to pin 1, etc. for Ethernet connection

Optional **IRT-UNV** (CT7003) IR Remote Control with two (2) AAA batteries (PS0154)

HDMI Cables Available from NTI

NTI#	Supported Resolution
HD-xx-MM Where xx= 3,6,10,15 and 20 Feet	4K@30/60Hz
HD4K18GB-FO-xxM-MM Where xx=10,15,20,25,30,50,70 and 100 Meters	4K@30/60Hz
HD-ACT-xx-MM Where xx=20,25,30,40,50,60 feet	4K@30/60Hz
HD-ACT-75/100-MM	4K@30Hz Only
DP-HD-15-MM (Use as source cable only)	4K@30Hz

Note: 4K in the above chart refers to both 3840x2160 and 4096x2160 resolutions

Contact your nearest NTI distributor or NTI directly for all of your cable needs at 800-RGB-TECH (800-742-8324) in US & Canada or 330-562-7070 (Worldwide) or at our website at <http://www.networktechinc.com> and we will be happy to be of assistance.

CONNECTORS AND LEDS

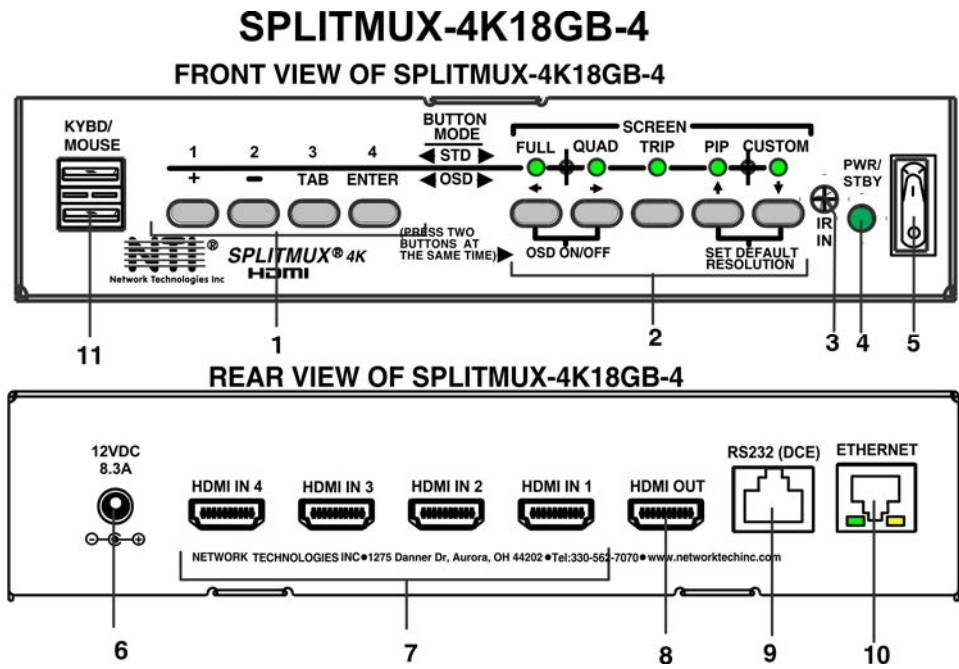

#	LABEL	CONNECTOR/LED	DESCRIPTION
1	1-4	Pushbuttons	HDMI Input Selection (Standard Mode)
	+, -, TAB, ENTER		OSD Menu Navigation (OSD Mode)
2	SCREEN-FULL, QUAD, TRIP, PIP, CUSTOM MODE (Display Modes)	Pushbuttons	For selecting the display mode for image placement on the user's monitor
	Directional Arrows		Used for OSD Menu positioning Also used to toggle the OSD Menu ON/OFF and returning the SPLITMUX to the default display resolution
3	IR IN	IR Sensor	Input sensor to receive IR signals from remote control
4	PWR/STBY	Green/Red LED	To indicate when the SPLITMUX is powered ON (Green) or in Standby (Red)
5		Rocker switch	For switching the SPLITMUX between ON (I) and Standby (O)
6	12VDC	Power Jack	For connection of power supply
7	HDMI IN 1-4	HDMI female connector	For connection of HDMI video sources
8	HDMI OUT	HDMI female connector	For connection of cable to HDMI Monitor
9	RS232 (DCE)	RJ45 female connector	For RS232 serial connection of a terminal to control the system
10	ETHERNET	RJ45 female connector	For connection to an Ethernet for remote multi-user control <ul style="list-style-type: none"> Yellow LED- indicates 100Base-T activity when illuminated, 10Base-T activity when dark Green LED – illuminated when Ethernet link is present, strobing indicates activity on the Ethernet port
11	KYBD/MOUSE	USB Type A Female X2	For connecting keyboard and mouse to control SPLITMUX from OSD menus

SPLITMUX-USB4K18GB-4

FRONT VIEW OF SPLITMUX-USB4K18GB-4-R

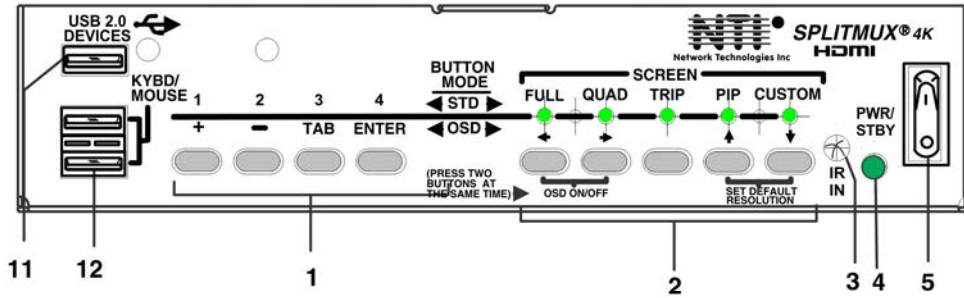

REAR VIEW OF SPLITMUX-USB4K18GB-4-R

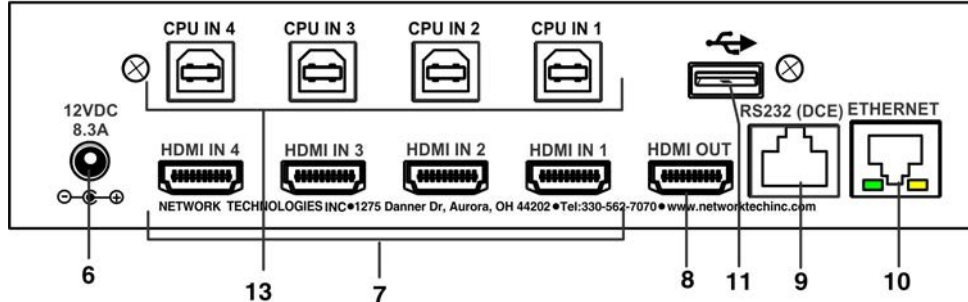

#	LABEL	CONNECTOR/LED	DESCRIPTION
1	1-4	Pushbuttons	HDMI Input Selection (Standard Mode)
	+, -, TAB, ENTER		OSD Menu Navigation (OSD Mode)
2	SCREEN-FULL, QUAD, TRIP, PIP, CUSTOM MODE (Display Modes)	Pushbuttons	For selecting the display mode for image placement on the user's monitor
	Directional Arrows		Used for OSD Menu positioning Also used to toggle the OSD Menu ON/OFF and returning the SPLITMUX to the default display resolution
3	IR IN	IR Sensor	Input sensor to receive IR signals from remote control
4	PWR/STBY	Green/Red LED	To indicate when the SPLITMUX is powered ON (Green) or in Standby (Red)
5		Rocker switch	For switching the SPLITMUX between ON (I) and Standby (O)
6	12VDC	Power Jack	For connection of power supply
7	HDMI IN 1-4	HDMI female connector	For connection of HDMI video sources
8	HDMI OUT	HDMI female connector	For connection of cable to HDMI Monitor
9	RS232 (DCE)	RJ45 female connector	For RS232 serial connection of a terminal to control the system
10	ETHERNET	RJ45 female connector	For connection to an Ethernet for remote multi-user control <ul style="list-style-type: none"> Yellow LED- indicates 100Base-T activity when illuminated, 10Base-T activity when dark Green LED – illuminated when Ethernet link is present, strobing indicates activity on the Ethernet port
11	USB	USB Type A Female	For connecting USB devices (mouse and keyboard) to control connected CPUs (SPLITMUX-USB4K18GB-4 only)
12	KYBD/MOUSE	USB Type A Female X2	For connecting keyboard and mouse to control SPLITMUX from OSD menus and Hot Mouse mode
13	CPU IN 1-4	USB Type B Female	For connecting USB device cables from connected PCs

MOUNTING

The SPLITMUX comes with parts and hardware for mounting in a rack. Follow the instructions below for assembly and installation.

The SPLITMUX can be mounted rear-facing or front-facing, so brackets will be attached to the case to enable mounting.

1. For a front-facing SPLITMUX, attach the mounting ears to the holes in the sides of the SPLITMUX using the #6-32 x 1/4" screws provided. Tighten the screws securely.

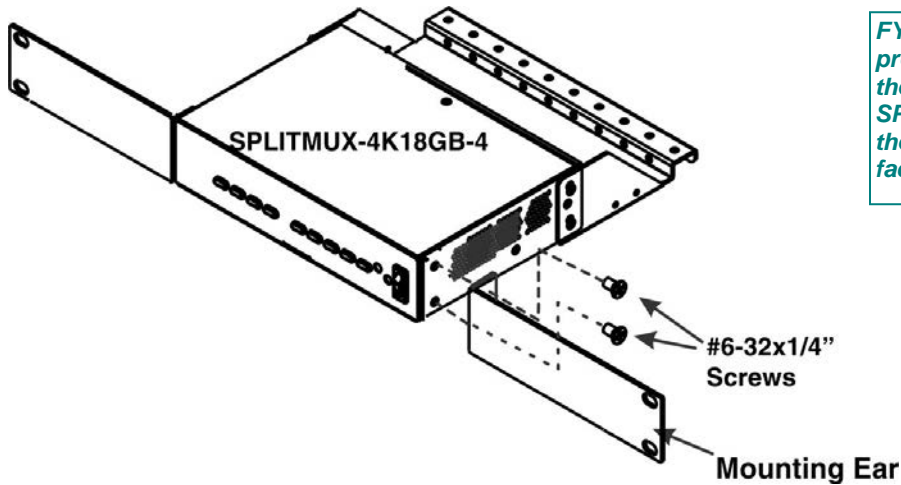

FYI: The same hole pattern is provided at the front and rear of the SPLITMUX, enabling the SPLITMUX to be mounted with the front facing out or rear facing out.

Figure 1- Attach ear brackets to front corners

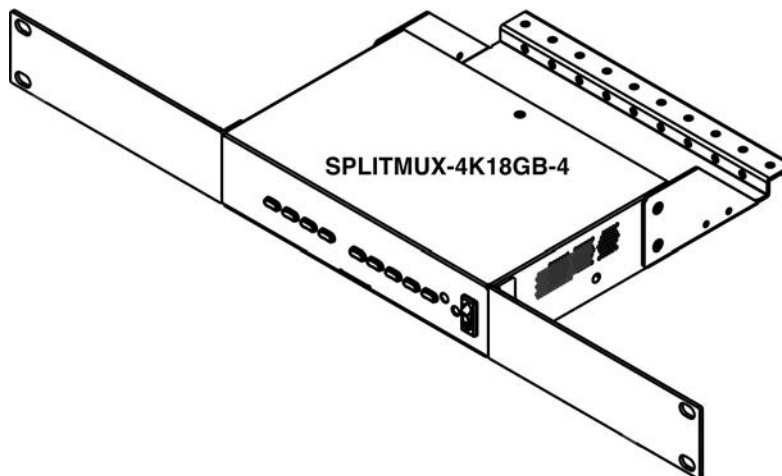

Figure 2- Assembled unit, ready to mount in rack

2. Install 4 cage nuts (provided) to the rack in locations that line up with the holes in the mounting ears on the SPLITMUX.
3. Secure the SPLITMUX to the rack using the four #10-32x3/4" screws provided. Be sure to tighten all mounting screws securely. The SPLITMUX is ready for mounting.

Note: Do not block power supply vents in the SPLITMUX case. Be sure to enable adequate airflow in front of and behind the SPLITMUX.

Note: If the mounting ears will be applied such that the rear will face out, you will need to disassemble the cable tray from the rear of the SPLITMUX as shown below. The cable management tray will not be used. Assemble the ear brackets to the holes vacated by the screws securing the cable tray.

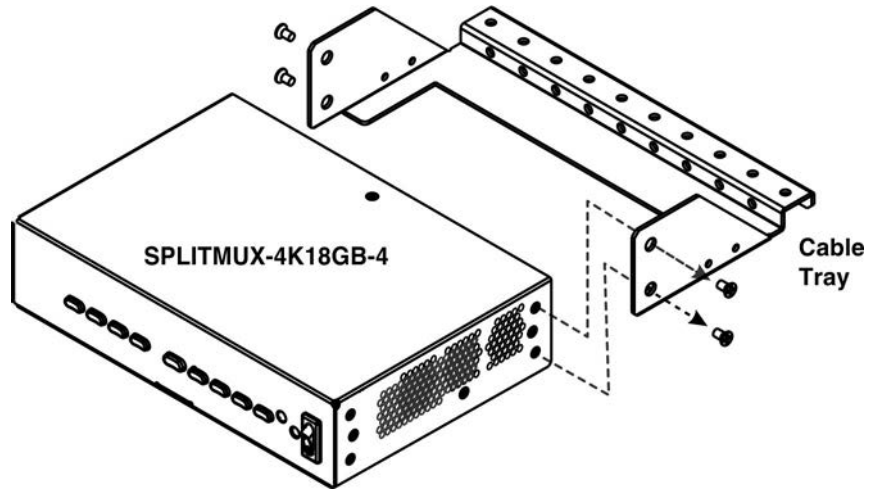

Figure 3- Remove cable tray (if applicable)

4. Install 4 cage nuts (provided) to the rack in locations that line up with the holes in the mounting ears on the SPLITMUX assembly.
5. Secure the SPLITMUX to the rack using the four #10-32x3/4" screws provided. Be sure to tighten all mounting screws securely.

INSTALLATION

1. Connect each of the HDMI or DVI video sources to the ports on the SPLITMUX marked "HDMI IN x" (x = 1-4).
2. Connect the display to the port marked "HDMI OUT".
3. Connect the power supply to the power jack and plug it in. In approximately 20 seconds, the LED on the SPLITMUX will illuminate red (standby).
4. Press the switch on the front to power the SPLITMUX ON. Within 20 more seconds the LED will change from red to green (ON) and the SPLITMUX will be ready to use.
5. For keyboard and/or mouse control of the OSD menu of the SPLITMUX, connect a USB keyboard and/or mouse to a USB type A port labeled "KYBD/MOUSE" on the SPLITMUX. The mouse connected to this port will also be able to open Hot Mouse mode (see page 14).

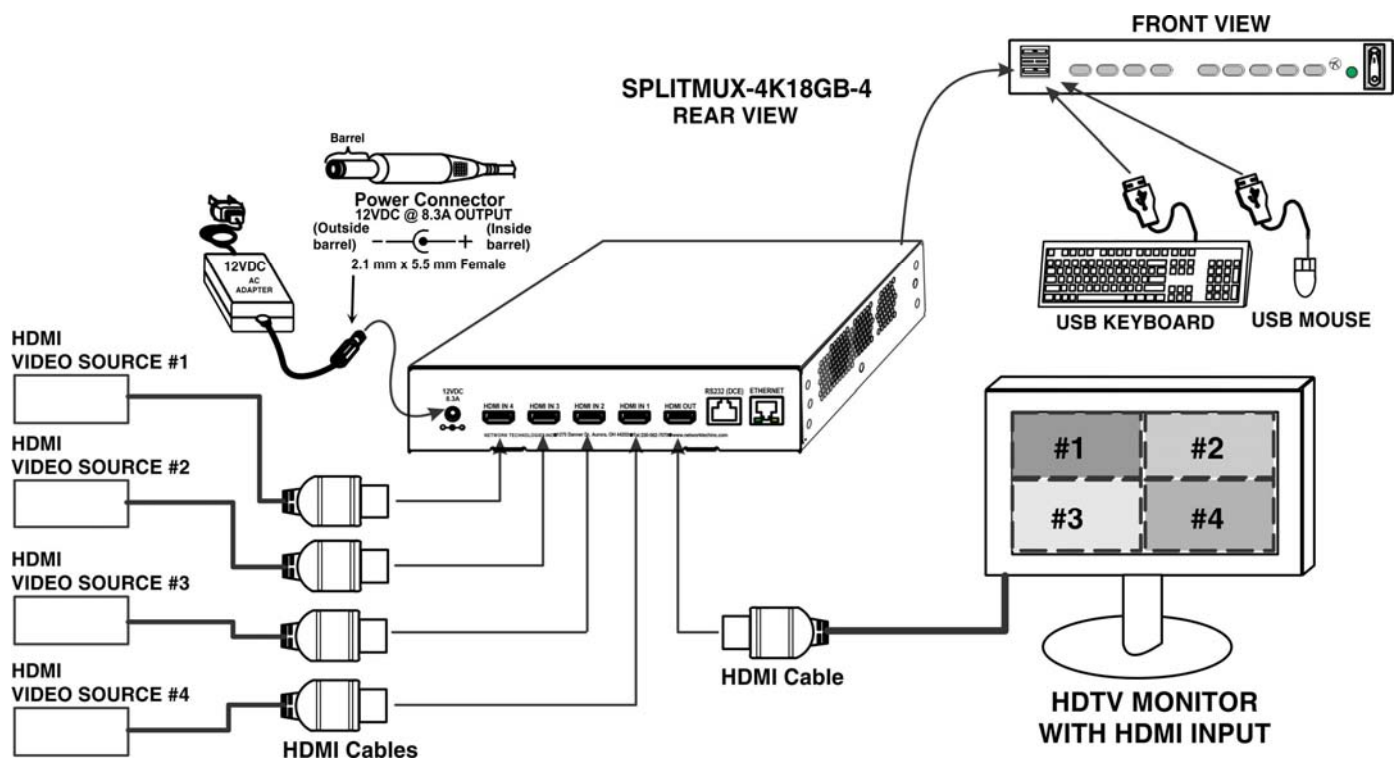



Figure 4- Video Source/Display Connections

Note: If the connected display does not support an HDMI input (typically it will have at least one HDMI input port), the display will not be compatible.

6. For SPLITMUX units supporting USB CPUs (SPLITMUX-USB4K18GB-4), a USB2-AB-xM cable (where x = 0.5 meter, 3,6,10 or 15 feet)(sold separately) can be connected between a USB port on the CPU and a “CPU IN x” port corresponding with the “HDMI IN x” port the video from the CPU is connected to.

7. Connect any desired USB devices to the ports labeled  .

With the connections made in steps 6 and 7, the keyboard connected to the “KYBD/MOUSE” ports and any USB device connected to the ports labeled  will be active for the connected CPU when the video from that CPU is selected in the SPLITMUX.

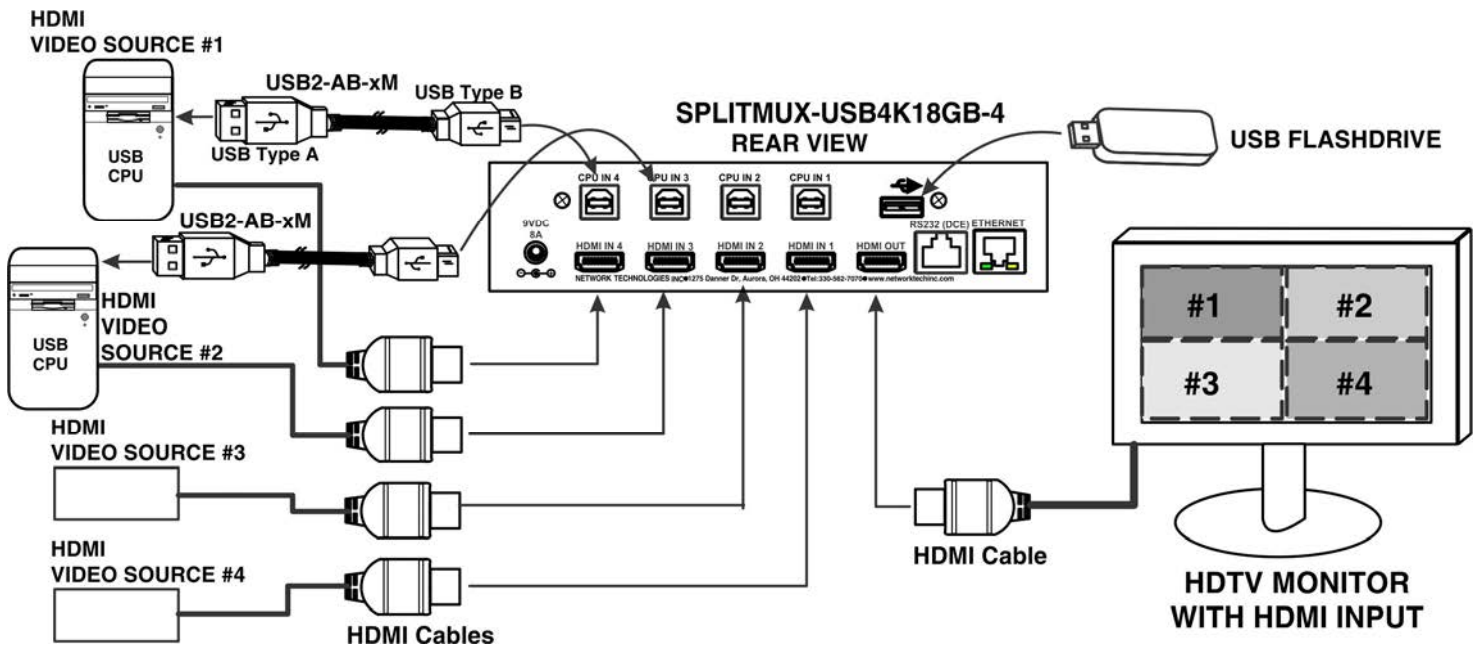

Figure 5- Video Source\Display Connections- SPLITMUX-USB4K18GB-4

Terminal Connection for RS232

If control via serial connection is going to be used, serial control can be achieved by connecting a control terminal to the “RS232” port .

To use the “RS232” port, connect one end of a CAT5 patch cable (supplied) to the port labeled “RS232” on the rear of the SPLITMUX. Plug the other end of the CAT5 cable into an RJ45-to-DB9F adapter (supplied), and then into a DB9M-to-USB type A male adapter and connect the adapter to a USB port on a computer running a terminal program. If the computer running the terminal program has a DB9M COM port on it, the serial adapter won't be necessary.

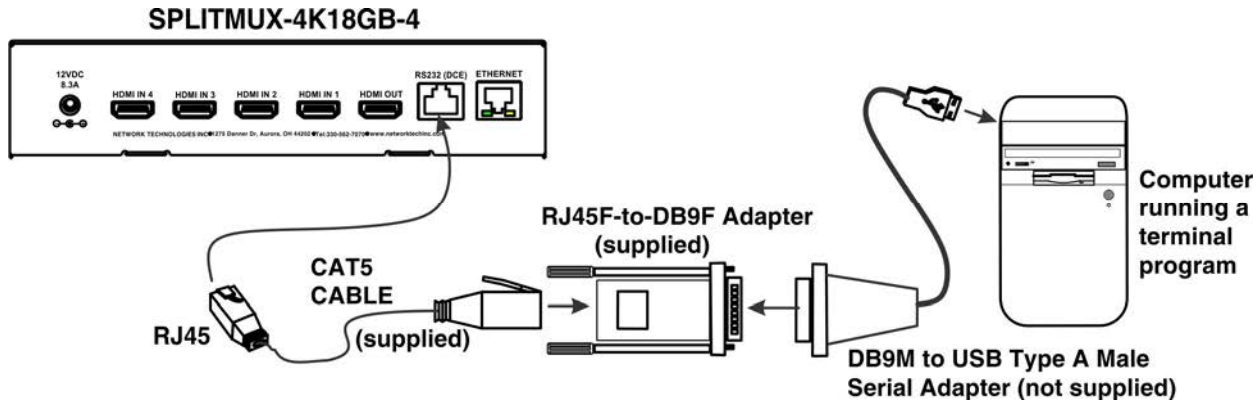

Figure 6- RS232 Terminal Connection

Ethernet Connection for Remote User Control

To make a remote connection, over the Ethernet, from anywhere on the local area network, connect a CAT5/5e/6 Ethernet cable with RJ45 male connectors on the ends, wired straight through (pin 1 to pin 1, pin 2 to pin 2, etc.). Up to 16 users can connect to the SPLITMUX at a time using the Ethernet.

Note: A direct connection from a computer's Ethernet port to the SPLITMUX “ETHERNET” port may also be made using the same cable.

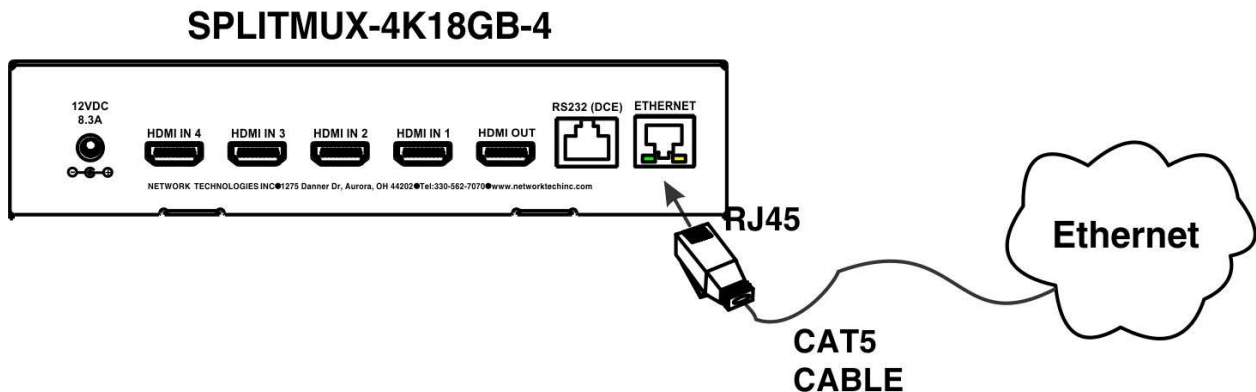

Figure 7- Ethernet connection

POWER ON

When you plug in the AC adapter between the SPLITMUX and your power supply, with the power switch OFF (switch towards “O”), the LED on the SPLITMUX will illuminate red after approximately 20 seconds. To use the SPLITMUX, press the power switch to ON (switch towards “I”). After 20 more seconds the LED will change from red (standby) to green (ON). The SPLITMUX is now powered up and ready to use.

When powering the SPLITMUX OFF, always press the power switch to OFF (switch towards “O”). Then wait 5 seconds or so until the green LED changes to red. Once it is red, you can then safely unplug the SPLITMUX from the power source.

WARNING: If you unplug the power source before powering OFF the SPLITMUX at the power switch, you may lose saved data and configuration information.

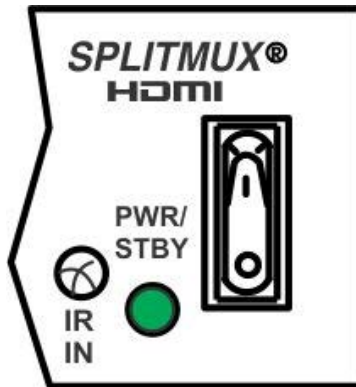

Figure 8- Power Switch and LED

CONTROL METHODS

The SPLITMUX can be controlled using any of seven methods;

- Standard Mode using the front panel buttons
- OSD Mode using the front panel buttons and/or keyboard and mouse,
- Using the Command Line Interface either through RS232 or remote connection
- Using a Text Menu either through RS232 or remote connection
- Using a hand-held IR Remote Control (purchased separately)
- Remotely through the Web Interface using an Ethernet connection.
- Hot Mouse Mode using only the mouse

Front Panel Buttons

The buttons on the front panel have two separate sets of functions, depending upon what mode the SPLITMUX is in; Standard Mode or OSD Mode.

Standard Mode

In Standard Mode, the left 4 buttons control which video source is viewed as the active image on the monitor, whether the SPLITMUX is in Full or PIP mode. The right 5 buttons determine which mode format the monitor will display the video signals in.

- When FULL is pressed, the input selected using buttons 1 through 4 (or "active" image) will be the only image on the display. The audio from the selected input will also be heard provided the audio input is set to "Automatic".(See pages 23 or 64)
- When QUAD is pressed, images from all 4 inputs will be displayed equally on the monitor. The audio from the last active image will continue to be heard.
- When TRIP is pressed, images from 3 of 4 inputs will be displayed equally on the monitor rotated by 90 degrees. The audio from the last active image will continue to be heard.
- When PIP is pressed, the active image will occupy the entire screen and the images from the remaining inputs will be displayed in lower resolution on the right side of the screen.
- When CUSTOM is pressed, the images will be displayed in whatever way you have the SPLITMUX configured to present them. Each input can be sized and positioned on the screen as desired.



In FULL screen mode, only the active video source will be displayed. The image will be viewed at full size and up to 4K resolution.



In QUAD screen mode, all four video sources share the screen equally. Each video source is displayed completely.

In PIP mode (right), either 2, 3 or all 4 video sources can be displayed, with the active source being displayed in its entirety on the full screen and the remaining selected images at a reduced resolution for simultaneous viewing. The position of the reduced images can be configured for preferred viewing.



In CUSTOM mode (left) the 4 video sources can be individually placed where ever you want, at what ever size you want, or not at all. The amount of each source that is viewed is determined by your configuration.

In Triple mode (right), 3 out of 4 video sources can be displayed, all of which are active and sharing the screen equally. The monitor is mounted vertically in this mode, and the video will output clockwise or counter-clockwise (user-selectable- depending upon how the monitor is rotated) to be viewed properly.



OSD Mode

In OSD Mode, the buttons are used to navigate and control the SPLITMUX using the OSD menu.

To bring up the OSD menu, press the FULL and QUAD buttons at the same time.

To exit the OSD menu, press the FULL and QUAD buttons at the same time again, or press <Esc> on the keyboard..

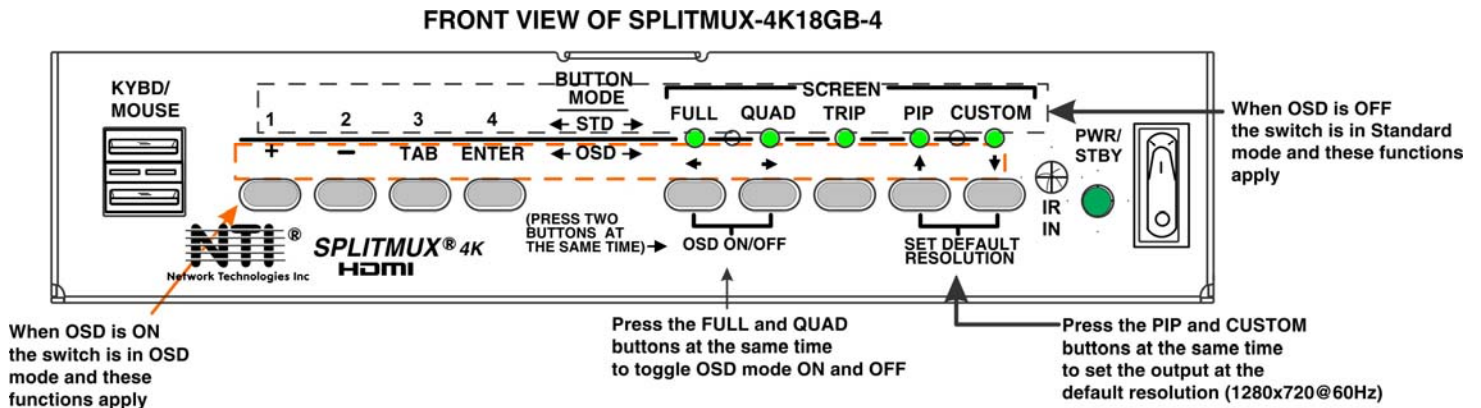

Figure 9- Front Panel Button Functions

Reset Resolution

In the event an incompatible resolution setting is applied to the SPLITMUX, to quickly restore the images of video sources to the SPLITMUX, press the PIP and CUSTOM buttons at the same time. This will reset the output to the default resolution of 1280x720 @60Hz.

Command Mode

The attached keyboard and mouse will, by default, control the PC supplying the active video. The keyboard can also be used for controlling Standard Mode functions as well as OSD Mode (see OSD menus on page 58).

To control the SPLITMUX using the keyboard, press <Ctrl> + <~> (accent/tilde key) on the keyboard (press at the same time) to enter Command Mode. While in Command Mode, all 3 status lights on the keyboard will illuminate to indicate that Command Mode is enabled.



When entering Command Mode, the Standard Mode functions will be controlled as follows:

Keypress	Function
1 thru 4	Select Channels 1 thru 4
F	switch to Full screen mode
Q	switch to Quad mode
T	Switch to Triple mode
P	switch to PIP mode
C	switch to Custom mode
O (Letter "O")	Toggle OSD Menu (Open/ Close)

OSD Menu Navigation:

Down Arrow or Tab	Move down thru OSD menu selections
Enter	Select the Menu item
Left/Right Arrow	Change values of menu item
L / R / U / D	Move the OSD screen on the display

Press <Esc> to exit Command Mode.

Hot Mouse Mode

Using the mouse that is plugged into the "KYBD/MOUSE" port on the SPLITMUX, the user can enter Hot Mouse mode by moving the mouse back and forth with a rapid motion. How sensitive the SPLITMUX will be to this motion is controlled under System Settings (see page 19). Hot Mouse mode can be opened while in FULL, PIP, QUAD or TRIP mode. Once Hot Mouse mode is active, SPLITMUX will temporarily switch to a format that looks like QUAD mode with the mouse floating across all 4 quadrants. Clicking on one video source will make that source the active input and return the SPLITMUX to the mode it was in.

Note: Hot Mouse mode will only be available to use while in FULL, PIP, QUAD and TRIP modes. It is not available in CUSTOM mode.

Moving the mouse back and forth in a rapid motion will open Hot Mouse mode, and using the mouse to select the desired active source will close Hot Mouse mode. Hot Mouse mode can also be closed by opening Command Mode while in Hot Mouse mode.

Note: While in Command Mode, Hot Mouse mode is not available to open.

The user can set the cursor moving speed on the display (see page 19). This can be adjusted from a range of 1-50, with 1 being the most amount of movement, and 50 being the least amount of movement. The default setting is 16.

DEVICE DISCOVERY TOOL

In order to easily locate NTI Devices on a network, the NTI Device Discovery Tool may be used. The Discover Tool can be downloaded from <http://www.networktechinc.com/download/d-4k-hdmi-multiviewer.html>, unzipped and saved to a location on your PC. To open it just double-click on the file `NTIDiscover.jar`. This will open the NTI Device Discovery Tool.

Note: The Device Discovery Tool requires the Java Runtime Environment (version 6 or later) to operate. Here is a [link to the web page from which it can be downloaded](#).

Note: The computer using the Device Discovery Tool and the NTI Device must be connected to the same subnet in order for the Device Discovery Tool to work. If no devices are found, the message “No Devices Found” will be displayed.

Tip: If your Windows program asks which program to open the `NTIDiscover.jar` file with, select the Java program.

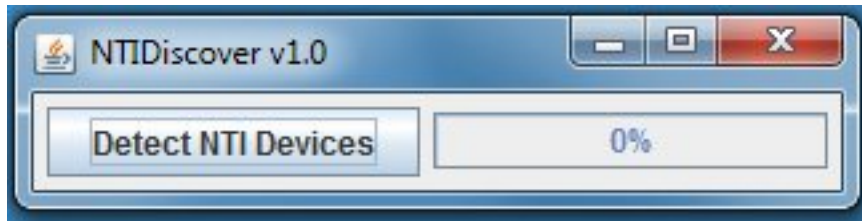

Figure 10- Device Discovery Tool

Click on the “**Detect NTI Devices**” button to start the discovery process. After a short time, the tool will display all NTI devices on your network, along with their network settings.

E-MICRO	00:0C:82:15:00:06	192.168.3.106	255.255.255.0	192.168.3.3	Submit	Blink LED
E-1W	00:0C:82:17:02:38	192.168.3.174	255.255.255.0	192.168.3.3	Submit	Blink LED
E-MICRO	00:0C:82:15:19:D9	192.168.3.111	255.255.255.0	192.168.3.3	Submit	Blink LED
IPDU-Sx	00:0C:82:08:00:77	192.168.3.220	255.255.255.0	192.168.3.3	Submit	Blink LED
SPLITMUX-4K18GB-4	00:0C:82:19:00:25	192.168.3.126	255.255.255.0	192.168.3.3	Submit	Blink LED
IPDU-S2	00:0C:82:05:00:CC	192.168.3.226	255.255.255.0	192.168.3.3	Submit	Blink LED
E-2DB	00:0C:82:0E:00:02	192.168.3.222	255.255.255.0	192.168.3.3	Submit	Blink LED
E-5DB	00:0C:82:10:06:3B	192.168.3.210	255.255.255.0	192.168.3.3	Submit	Blink LED
E-2DB	00:0C:82:0E:00:0F	192.168.3.88	255.255.255.0	192.168.3.3	Submit	Blink LED

How to Use the Device Discovery Tool

To Change a Device’s Settings, within the row of the device whose settings you wish to change, type in a new setting and click on the **Enter** key, or the **Submit** button on that row. If the tool discovers more than one device, the settings for all devices can be changed and you can click on the **Submit All** button to submit all changes at once.

To Refresh the list of devices, click on the **Refresh** button.

To Blink the LEDs of the unit, click on the **Blink LED** button (This feature is not supported on all products.) The **Blink LED** button will change to a “**Blinking....**” button. The LEDs of the unit will blink until the **Blinking...** button is clicked on, or the NTI Device Discovery Application is closed. The LEDs will automatically cease blinking after 2 hours.

To Stop the LEDs of the unit from blinking, click on the **Blinking...** button. The **Blinking....** button will change to a **Blink LED** button.

USE AND OPERATION VIA WEB INTERFACE

A user may configure the settings of the SPLITMUX using the Web Interface via any web browser (see page 2 for supported web browsers). To access the Web Interface, connect the SPLITMUX to the Ethernet (page 9). Use the Device Discovery Tool (page 15) to setup the network settings. Then, to access the web interface controls, the user must log in.

Note: In order to view all of the graphics in the Web Interface, the browser's JavaScript and Java must be enabled.

By default, the SPLITMUX is configured to dynamically assign network settings received from a DHCP server on the network it is connected to. (This can be changed to a static IP address to manually enter these settings in the Network Settings on page 20.) The SPLITMUX will search for a DHCP server to automatically assign its IP address each time the unit is powered up. If the SPLITMUX does not find a DHCP server, the address entered into the static IP address field (page 20-default address shown below) will be used. If a DHCP server on the network has assigned the IP address, use the Device Discovery Tool to identify the IP address to enter when logging in to the SPLITMUX, or use the OSD menu to view the System Info page.

Note: The computer using the Device Discovery Tool and the NTI Device must be connected to the same subnet in order for the Device Discovery Tool to work. If no devices are found, the message "No Devices Found" will be displayed.

Log In and Enter Password

To access the web interface, type the current IP address into the address bar of the web browser. (The default IP address for the SPLITMUX is shown below):

http://192.168.1.30

To open a SSL-encrypted connection, type:

Address

https://192.168.1.30

A log in prompt requiring a username and password will appear:

Username = root

Password = nti

(lower case letters only)

Note: usernames and passwords are case sensitive

Login

The screenshot shows a web browser window with a login form. The form has a title bar that says "Enter login credentials". Below the title bar, there are two rows of input fields. The first row is labeled "Username" and has a text input field with the placeholder "Enter the username to log in with". The second row is labeled "Password" and has a text input field with the placeholder "Enter the associated password". At the bottom left of the form, there is a button labeled "Login".

Figure 11- Login prompt to access web interface

With a successful log in, a screen similar to the following will appear:

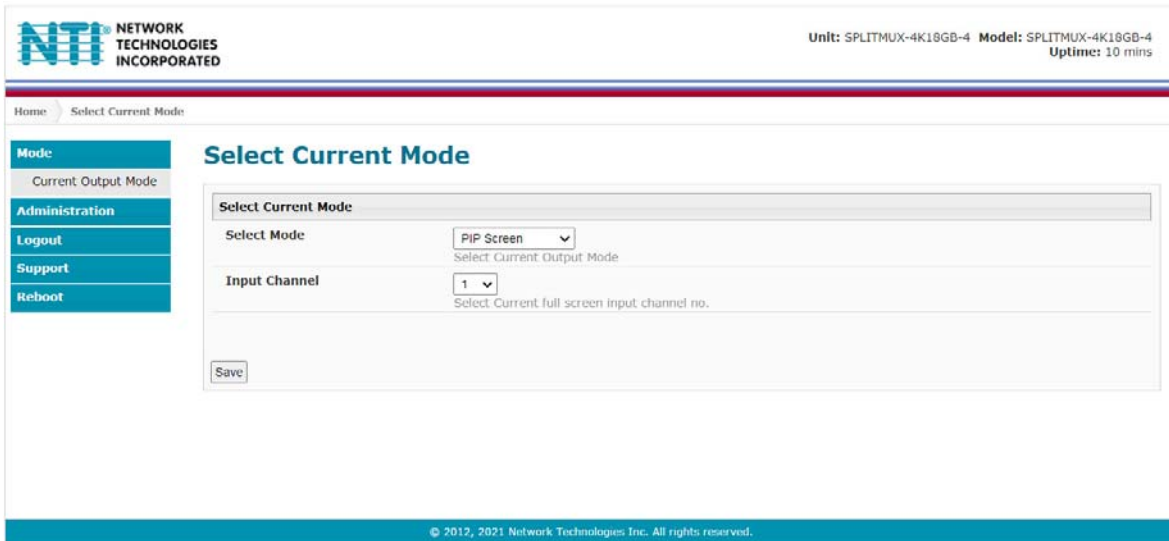

Figure 12- Initial page- Administrator

The initial page is the Mode page where the current operating mode of the SPLITMUX is selected and the input channel to be displayed in Full Screen mode is assigned. A menu to the left is presented to administrative users with access to all pages used to manage the functions of the SPLITMUX. When the selected mode is Quad, PIP , TRIP or Custom the Input Channel selected indicates which input will pass audio through to the output (provided the audio mode for each input is set to Automatic (page 23).

Function	Description
MODE	Select the current operating mode and main input channel
ADMINISTRATION	Configure all network and multi-user access settings (page 19)
LOGOUT	Log the user out of the SPLITMUX web interface
SUPPORT	Links for downloading a manual or firmware upgrades
REBOOT	Enables user to reboot the SPLITMUX using the web interface

A non-administrative user will only have access to select the current mode or to the support links.

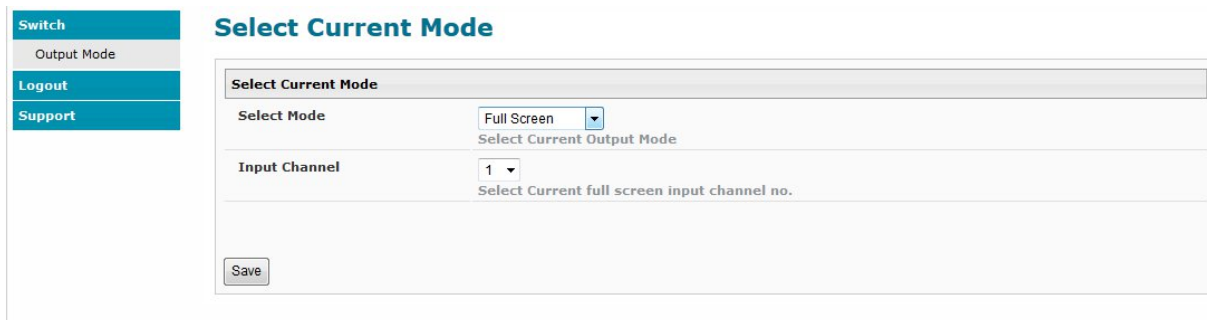

Figure 13- Initial page- Non-Admin User

Administration	
System	Fields for applying unit settings (name and keypad PIN), Serial configuration settings, OSD screen position, and configuration backup and restore options
Network	Fields for providing all the network settings to the SPLITMUX and access control settings
Input Settings	Display configuration settings for each input channel
Output Settings	Video and Audio controls for the output channel
Mode Settings	All settings for each operating mode of the SPLITMUX
Custom Settings	Settings for customizing the layout of the channels on the display
Cascade Settings	Settings to control cascading of the video and audio inputs/outputs on other SPLITMUXs to/from this SPLITMUX
User Config	Fields for assigning users, access privileges, passwords, contact settings, and schedule settings
Firmware	For updating the firmware of the SPLITMUX when improved software becomes available.
System Information	Provides firmware version, MAC address, network settings and input connection status

Administration-System

The System Configuration page provides blocks to enter the switch name and a PIN number that will be used to allow access to the SPLITMUX from the front panel. The name will appear on each page in the web interface identifying which SPLITMUX is being controlled. Hot Mouse settings provide greater control over the sensitivity of the SPLITMUX to the user. Serial port settings for communication with the unit can be entered and the position of the OSD menu on the monitor is defined. Configuration Backup and Restore provides utility for saving all configuration settings to a file on your PC and being able to restore them at any time, in addition to being able to restore the SPLITMUX to default settings with the click of a button.

System Configuration

Unit Settings

Name
Unique name for this unit

Keypad PIN
PIN for keypad. Enter digits 1-4. Any 0 in the digits will reset the PIN to 0000. Use 0000 for no PIN.

Hot Mouse Settings

Hot Mouse Trigger Sensitivity
Sensitivity to shake and trigger hot mouse mode. 1-70 (1 is most sensitive, default is 10)

Hot Mouse Cursor Sensitivity
Sensitivity of mouse movement once in hot mouse mode. 1-50 (1 is most sensitive, default is 16)

Serial Port Settings

Baud Rate Baud Rate for RS232 Commands

Serial Address Address for RS232 Commands and System Address

OSD Screen Settings

Horz Offset OSD Horizontal Offset from left (0-70%)

Vert Offset OSD Vertical Offset from Top (0-70%)

Configuration Backup & Restore

Choose File No file chosen
Choose configuration file to restore.
Note: system will reboot to apply the configuration.

Note: Changing the OSD Screen Settings will only be effective when the output resolution is set to 1080P or less. When set above 1080P, the default settings of 10 will take effect, regardless of what these values are changed to.

Figure 14- System Configuration

System Settings	Description
Unit Settings	
Name	Unique name for this SPLITMUX to appear on the login page and header of each web interface page
Keypad Pin	PIN number that must be entered before using the keypad to change settings- 4 digits using buttons 1-4. Enter 0000 for no pin.
Hot Mouse Settings	
Hot Mouse Trigger Sensitivity	Sensitivity level for the SPLITMUX to trigger Hot Mouse mode. Range is 1-70. 1 = most sensitive 70 = least sensitive (10 = default setting)
Hot Mouse Cursor Sensitivity	Sensitivity level of mouse movement when in Hot Mouse mode. Range is 1-50. 1 = most sensitive 50 = least sensitive (16 = default setting)
Serial Port Settings	
Baud Rate	Baud rate for RS232 commands- select a value between 1200 and 115200 bps
Serial Address	Serial Address for RS232 commands and for the IR Remote- select value from 1-15
OSD Screen Settings	
Horiz Offset	OSD Horizontal Offset from left (0-70%)
Vert Offset	OSD Horizontal Offset from top (0-70%)
Configuration Backup and Restore	
Choose file	Browse for a saved configuration file to be restored to the SPLITMUX. Upon selection, press "Save" and the SPLITMUX will restore the configuration settings and reboot. Allow 1 minute before trying to reconnect and log in again. <i>Note: The IP address will be set to the IP address in the file and may be different</i> <i>Note: Before overwriting the existing configuration, consider whether the existing configuration should be saved first. If it will be saved, be sure to save the current configuration file under a different name than the configuration file to be loaded.</i>
Upload Config	Click on the Browse button to browse to the file, then click on " Upload Config ", and restore the SPLITMUX to the configuration stored in the uploaded file.
Download Configuration File	Click this button to save the configuration of the SPLITMUX to a location on your PC. This file can be restored using the "Upload Config" button in the event you wish to return the SPLITMUX to a former state
Restore Defaults	Click this button to restore the SPLITMUX to the configuration settings it had upon receipt from the factory. Be careful! This will erase <u>all</u> user configuration settings. Upon restoration, the SPLITMUX will reboot. Allow 1 minute before trying to reconnect and log in again. Confirmation to use this is required.

Administration-Network

The Network Configuration page is where all network settings are entered. These settings determine how you will remotely access the SPLITMUX.

Network Configuration

This IP address is ONLY used if the Mode is set to "Static" (settings are grayed-out when set to DHCP). The System Information page always shows the assigned IP address whether the Mode is set to "Static" or "DHCP". (See page 32)

Note: When Mode is set to "DHCP With Failover", in the event the DHCP server is not available, the SPLITMUX will automatically revert to the Static IP address as set.

Figure 15- Network Configuration

IP Settings	Description
Mode	Select the method for acquiring IP Settings- Static (manual), DHCP with Failover (automatic) or Disable. Failover enables the SPLITMUX to automatically switch to the Static Mode IP settings in the event the DHCP server is not available. (default is DHCP With Failover)
IP Address	Enter valid IPv4 address (for Static Mode) (default is 192.168.1.30)
Subnet Mask	Enter valid subnet mask (for Static Mode)
Default Gateway	Enter valid default gateway (for Static Mode)
Primary DNS Address	Enter preferred name server (for Static Mode)
Alternate DNS Address	Enter alternate name server (for Static Mode)
When in DHCP mode, the Primary and Alternate DNS addresses are set by the DHCP server.	
Server Settings	Description
Enable Telnet	Place a checkmark in the box to enable access to the SPLITMUX via Telnet The default is Disabled.
Allow HTTP access	Place a checkmark in the box to enable access to the SPLITMUX via standard (non-secure) HTTP requests (default is enabled)
HTTP Port	Port to be used for standard HTTP requests
HTTPS Port	Port to be used for HTTPS requests
Web Timeout	Number of minutes after which idle web users will be logged-out (maximum is 32000, enter 0 to disable this feature)

Note: If you select "DHCP" for the mode, make sure a DHCP server is running on the network the SPLITMUX is connected to.

Administration- Input Settings

Video Input Settings

Input Channel 1 Configuration

Input Channel 1 Port Name
Name for input port

Enable Enable ▾
Enable / Disable Input Channel 1

Input Channel 2 Configuration

Input Channel 3 Configuration

Input Channel 4 Configuration

Figure 16- Input Settings

Input Settings	Description
Input Channel x Port Name	Enter a port name to associate with the video source on Input 1
Enable	Choose to Enable or Disable the video input for this channel

Each Input channel can be configured with these settings.

Note: Make sure the input channel port names contain at least 7 characters (including spaces) or they will not be controllable through the Serial/Telnet interface (page 40).

Administration- Output Settings

Output Settings

Output Configuration

Output Port Name:
Name for output port

Output Resolution:
Select output resolution. Auto will choose from EDID.

Transmitter Settings Freeze:
Corrects some of output display issues by freezing Output side settings. When resolution changes, display color changes may not work. Default: No

Config output for Input 1 audio

Audio level: -96 dB | -48 dB | 0 dB (L, R)

Audio Gain:

Audio Mode:
Choose output mode for Audio input.

Config output for Input 2 audio

Audio level: -96 dB | -48 dB | 0 dB (L, R)

Audio Gain:

Audio Mode:
Choose output mode for Audio input.

Config output for Input 3 audio

Audio level: -96 dB | -48 dB | 0 dB (L, R)

Audio Gain:

Audio Mode:
Choose output mode for Audio input.

Config output for Input 4 audio

Audio level: -96 dB | -48 dB | 0 dB (L, R)

Audio Gain:

Audio Mode:
Choose output mode for Audio input.

Figure 17- Output Settings

Video Output Configuration	Description
Output Port Name	Enter a port name to associate with the display
Output resolution	Select the output resolution to send to the display or select "Auto" to have it choose from the EDID table.
Transmitter Settings Freeze	Select Yes or No (No is default). When "Yes" is selected, some settings like resolution changes or display color settings may not work. You can select "Yes" to debug output side display issue. Please note this setting will reset on reboot of device and is not saved to config

Note: When the Output resolution is set to "Auto", your SPLITMUX will automatically sense the native resolution of your monitor and set the output resolution to that when powering ON the SPLITMUX.

Audio Level and Gain

The Audio level bar indicates the sound level output for the left and right speakers of that input channel. The level “-96dB” indicates minimum sound output and “0dB” indicates maximum sound output. The audio level can also be viewed on the display (see Figure 18) when enabled through the web interface (see Figure 22).

The Audio Gain provides control over the Audio level output by the SPLITMUX. Drag the slide button to the left or right to adjust the audio level. If the Audio level indicates -96dB for an input channel, it means there is no audio at that source.

Note: *If sliding the Audio Gain button towards 0.00 dB results in the Audio level reaching 0 dB, back it down towards the left enough to reduce the Audio level to at least -3dB (red arrow in Fig. 20.). Levels higher than 0dB will likely result in significant audio static or noise.*

Note: *The audio that is heard is determined by the Audio Mode Settings (below) and the Input Channel selected under Current Output Mode (page 17).*

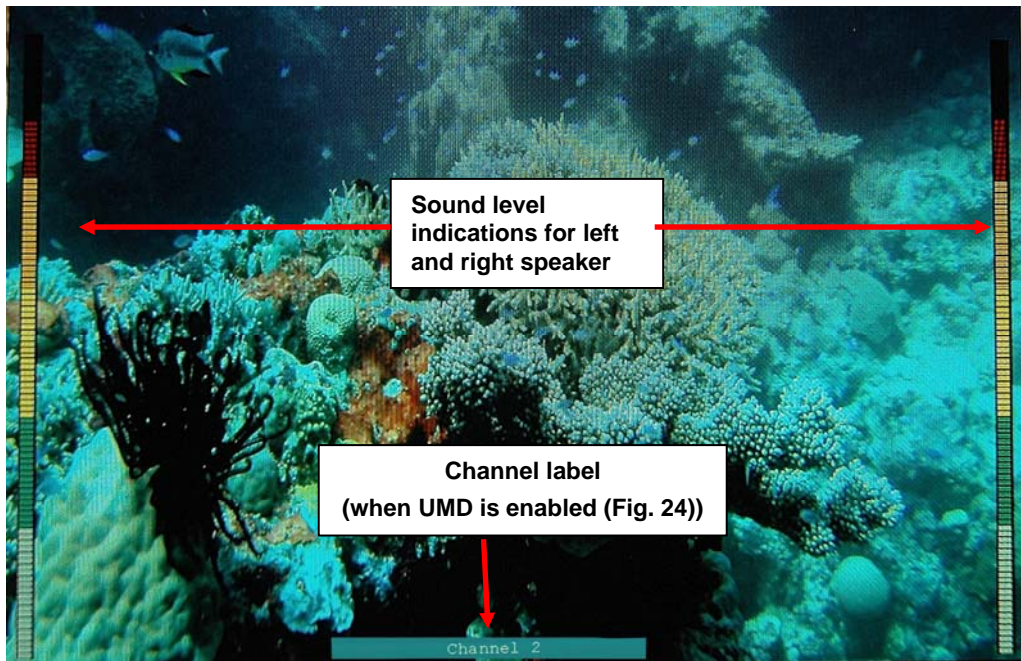

Figure 18- Display with sound level indications

Audio Mode Settings

When Audio Mode is **enabled**, the audio will come through any time the input signal is present (whether the video is enabled or not).

When Audio Mode is **disabled**, no audio will be heard from that input.

When Audio Mode is **automatic**, the audio will only be heard from that input if that input is the currently active input. To avoid confusion from multiple audio inputs when using Quad, TRIP or PIP modes, set each audio input to automatic.

Administration-Mode Settings

Mode Settings

Figure 19- Mode Settings

Power Up Mode Setting	Description
Power Up Mode	Choose the mode the SPLITMUX will be in when powered ON
Full Screen Mode Settings	Description
Input Channel	Select the input channel assigned to Full Screen
Enable Scan	Enable scanning for the full screen input channel- to automatically switch from one channel to another
Scan time	Set the dwell time while scanning- the amount of time (in seconds) each channel will appear at full screen- range is 0-999
Scan input 1	Enable or disable to include input 1 in the scanning sequence
Scan input 2	Enable or disable to include input 2 in the scanning sequence
Scan input 3	Enable or disable to include input 3 in the scanning sequence
Scan input 4	Enable or disable to include input 4 in the scanning sequence
Quad Screen Mode Settings	Description
Enable Border	Place a border around each input displayed
Border Color	Choose the color of the border around each input
Border Width	Choose the width of the border around each input- from 0-50 pixels
Enable Aspect Ratio	Enable to maintain the aspect ratio for each displayed image

Triple Screen Mode Settings	
Rotation Direction	Counter clockwise Select image rotation direction
Enable Aspect Ratio	<input type="checkbox"/> Preserve input aspect ratio for all outputs
Top Screen	1 Select input for top screen
Middle Screen	2 Select input for middle screen
Bottom Screen	3 Select input for bottom screen
Enable Border	<input type="checkbox"/> Enable Border for each output
Border Color	YELLOW Select Color of Border
Border width	5 Border width in 0 - 50 pixels.

Figure 20- Triple Screen Mode Settings

Triple Screen Mode Settings	Description
Rotation Direction	Choose a Clockwise or Counter-clockwise image rotation direction
Enable Aspect Ratio	Click to Enable to maintain the input aspect ratio for each displayed image
Top Screen	Select which of the 4 inputs should be on top
Middle Screen	Select which of the 4 inputs should be in the middle
Bottom Screen	Select which of the 4 inputs should be on bottom
Enable Border	Place a border around each input displayed
Border Color	Choose the color of the border around each input (see Figure 19 for options)
Border Width	Choose the width of the border around each input- from 0-50 pixels (0= no border)

Top/Middle/Bottom Screen

Select which of the 4 inputs should be on top, in the middle, and on the bottom of your monitor. If you select the same input for two positions, you will receive an error message **"Error: Duplicate selection detected in triple mode screen input!!"**

PIP Screen Mode Settings	
Active Channel	1 <input type="button" value="v"/> Default active full screen input channel no.
Enable Full Screen	<input checked="" type="checkbox"/> Enable Active input in full screen mode with overlay
Enable Aspect Ratio	<input type="checkbox"/> Preserve input aspect ratio for all outputs
PIP Mode	Triple <input type="button" value="v"/> Select pip screen mode.
PIP1 Input	2 <input type="button" value="v"/> PIP screen 1 input channel no.
PIP2 Input	3 <input type="button" value="v"/> PIP screen 2 input channel no.
PIP3 Input	4 <input type="button" value="v"/> PIP screen 3 input channel no.
PIP Horz. Position	80 <input type="text"/> Horizontal position of PIP from left 0-90%.
PIP Vert. Position	0 <input type="text"/> Vertical position of PIP from top 0-66%.
PIP Size	20 <input type="text"/> Size of PIP 10-50%.
Enable Scan	<input type="checkbox"/> Enable input channel scanning
Scan Time	15 <input type="text"/> Scan time in seconds.
Enable Active Scan	<input type="checkbox"/> Enable active/full screen channel scanning in Single mode
Enable Border	<input type="checkbox"/> Enable Border for pip
Border Color	BLUE <input type="button" value="v"/> Select Color of Border
Border width	5 <input type="text"/> Border width in 0 - 50 pixels.
<input type="button" value="Save"/>	

Figure 21- PIP Screen Mode Settings

Pip Screen Mode Settings	Description
Active Channel	Select which active channel is in full screen mode
Enable full screen	Enable active input in full screen mode with overlay of PIP image. If deselected, active input will shrink to prevent overlay of PIP image.
Enable aspect ratio	Enable to maintain the aspect ratio for all displayed images
PIP Mode	Select how many PIP images will be displayed, 1, 2 or 3 (the Active channel will be at full screen)
PIP 1 Input	Select which input channel will be in PIP upper right position
PIP 2 Input	Select which input channel will be in PIP center position
PIP 3 Input	Select which input channel will be in PIP lower right position
PIP Horz. Position	Position of PIP images from the right side of the screen- range is 0-90% of screen width
PIP Vert Position	Position of uppermost PIP from the top of the screen- range is 0-60% of screen height
PIP Size	Size of the PIP image- range is 10-50%
Enable Scan	Enable input channel scanning when PIP Mode is set to "Single" or "Triple"
Scan Time	Set the dwell time while scanning- the amount of time (in seconds) each channel will appear in the single PIP position- range is 0-999
Enable Active Scan	Enable full screen scanning between the inputs while in "Single" PIP mode Note: If "Enable Scan" is selected, Active Scan will be automatic in "Triple" PIP mode so the option to enable/disable it will not be available.
Enable Border	Place a border around each input displayed
Border Color	Choose the color of the border around each input (see Figure 19 for options)
Border Width	Choose the width of the border around each input- from 0-50 pixels

Single PIP Mode

When in Single PIP Mode, the PIP window will be in the upper right position by default. You can adjust the vertical position on the screen by setting the "**PIP Vert Position**".

With "**Enable Scan**" selected, the SPLITMUX will scan each of the non-active channels and alternate between them in the PIP image for the selected **Scan Time**. The selected **Active Channel** will remain unchanged on the screen.

With "**Enable Active Scan**" selected, the SPLITMUX will scan all channels including the **Active Channel** and take turns displaying each channel in the PIP window as well as changing the Active Channel image at full screen.

Double PIP Mode

When in Double PIP Mode, the **PIP Vert. Position**, **Enable Scan**, **Scan Time** and **Enable Active Scan** features will not be available. Selected PIP 1 and PIP 2 inputs will be displayed in PIP.

Triple PIP Mode

When in Triple PIP Mode, all channels will be displayed, one as Active and three as PIP. The **Vert. Position** option will not be available and will be greyed out.

When "**Enable Scan**" is selected, all channels will be scanned and each will be made Active for the selected **Scan time**. The **Enable Active Scan** function will be the default and therefore not be selectable.

Administration- Custom Settings

Using the Custom Mode Settings page you can individually customize how you want the video from **each channel** to appear on the display.

The screenshot displays the Custom Screen Mode Settings interface for a 4K 18GB Multiviewer. At the top, there are 10 preset layout thumbnails labeled layout 1 through layout 8. Below this is a main display area showing four channels (Channel 1, 2, 3, 4) with colored borders (blue, yellow, green, red) indicating their positions. A callout box labeled "10 Preset Layouts" points to the top row of thumbnails, and another labeled "View of display positions by channel" points to the main display area.

Below the display area is a toolbar with "Alignment Tools" (curved arrows and grid icons) and a "Mode" selector with options for "Move & Scale" (selected) and "Pan & Crop". It also includes "Snap To Grid" checkboxes, "Rows: 10" and "Columns: 10" settings, and "Output Resolution: 3840 X 2160".

The bottom section contains configuration panels for each channel (Channel 1, 2, 3, 4). Each panel includes:

- Channel enable/disable checkboxes (Ch 1-4).
- Update Layout: Choose File, No file chosen, Select Layout to Update (dropdown), and Download Layout: Select Layout to Download (dropdown), Download.
- Channel-specific settings: Aspect Ratio (Free Ratio), Border Width (0), Border Color (BLACK), Transparency (0%), Zoom (100%), Display VOL-L, Display VOL-R, Display UMD, and Enable Audio.
- Default Size/Pos: Width (1920), Height (1080).

Callout boxes provide additional instructions:

- "Enable/Disable and Label each channel" points to the channel enable checkboxes.
- "Restore saved layout" points to the "Select Layout to Update" dropdown.
- "Download to save layout" points to the "Download" button.
- "Restore to full screen at either native resolution or a combination of output and native (whichever is lower)" points to the "Default Size/Pos" section.
- "Configure the size, position, appearance of each input channel" points to the channel-specific settings.
- "Turn ON/OFF audio for each channel (effects Custom Mode performance only)" points to the "Enable Audio" checkboxes.
- "Show audio levels for the channel on the display" points to the "Display VOL-L" and "Display VOL-R" checkboxes.
- "Enter checkmark to show channel label on the display" points to the "Display UMD" checkboxes.

Figure 22- Custom Screen Mode Settings

Preset Layouts and Display Preview

You can use any of the 10 preset layouts (use the slide bar to scroll to 9 and 10) or you can change the presets to a custom configuration and save those as well.

The window below the presets provides a preview of the spacing of each channel on the display.

When you click on a channel within the window, the box will turn grey to indicate it has been selected. While selected, you can click and drag any point on the border to resize the channel. Click within the channel and drag to relocate the channel on the display.

Note: If you click on a channel that covers another channel (bringing the selected channel to the front), you won't be able to re-select the covered channel unless you either move the selected channel or click the disable/enable block for the covered channel to bring the covered channel to the front again.

Alignment Tools

Alignment tools enable the user to select two channels and quickly have them positioned in relationship to each other. Select one channel, press the <Ctrl> key and select another channel. Then click an alignment tool. The second channel will move in relationship to the first channel based on the tool you selected. Select Undo or Redo to reverse or repeat an action.

Enter a checkmark in **"Snap To Grid"** to manually drag channels to invisible grid points for easy alignment of the displayed images. The distance between grid points is adjusted by changing the numbers of "Rows" and "Columns" (default is 10).

Click the radio button **"Move & Scale"** (the default) to be able to move the position of the channel on the display. Drag the corners of the channel to change the size of the displayed image in relationship to your selected aspect ratio (See Aspect Ratio under Channel Settings- page 30)

Click the radio button **"Pan & Crop"** to enable panning and cropping of the viewed image.

Note: For Pan to work, the image must first be zoomed or cropped (see Channel Settings – page 30).

When "Pan & Crop" is selected, the displayed image will not change in size, but rather your adjustments will change what portion of the viewed image is visible.

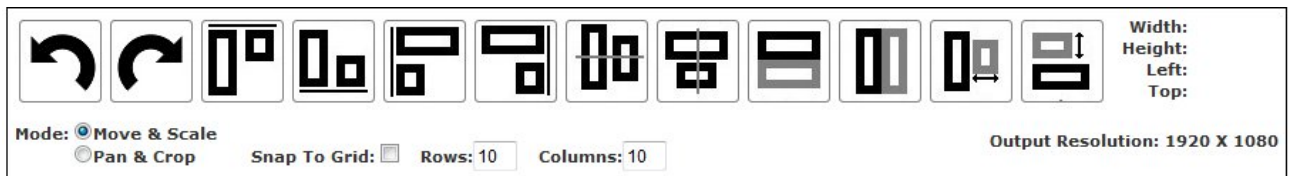

With the image zoomed, use the "Pan & Crop" feature to bring your preferred area of focus into view. When the "Pan & Crop" feature is enabled, a grid will appear in the web interface to represent the image being adjusted.

Either click and drag the grid itself to pan your view, or click on the edges of the image box (top, bottom, left or right) and drag the edge in to hide that portion of the image you don't need to see. (You will want to view the actual display as you do this to see what portion of the image you are hiding.) When panning, the edges of the grid will tell you where the image edges are (if you aren't looking at the actual display when you adjust this).

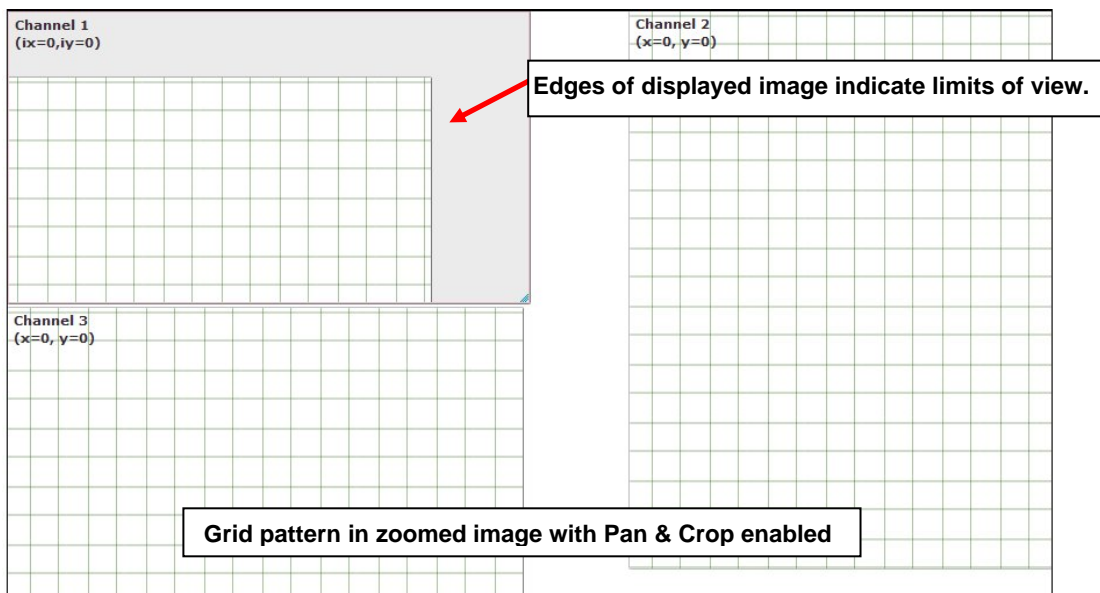

Figure 23- Pan and Crop Enabled

Individual Channel Settings

The settings applied here will impact only the individual channel being configured.

The Aspect Ratio can be configured to be a Fixed or Free Ratio.

When set to **Fixed Ratio**, no matter what size you drag the channel to be, the viewed image will retain the ratio of the source.

When set to **Free Ratio**, the displayed video will adjust to whatever size or shape you have dragged that channel to be.

To switch between aspect ratio settings, click on the drop-down arrow and select the desired setting.

Note: When you switch from Free Ratio to Fixed Ratio after having resized the image, the image on that channel will automatically crop to retain the displayed size and shape while adjusting to the proper aspect ratio.

The border width can be set from 0-50 pixels (0 = no border).

The border color is selected from an array of options by clicking on the arrow.

Control the level of transparency for an input by sliding the “Transparency” button to the right.

Use the Zoom slider to zoom in on the image to enlarge your view of the source. Zoom range is from 100% (full size) to 500%.

With the image zoomed, you can also use the “Pan and Crop” feature (see **Alignment Tools- page 29**) to bring your preferred area of focus into view.

Place a checkmark in “VOL-L” and/or “VOL-R” to display audio levels to the left and right of the video on the display for that channel. (See Figure 18 on page 23).

Place a checkmark in “UMD” (Under Monitor Display) to show the channel name beneath the video on the display.

Note: The audio level and UMD will only be viewable on the display when the SPLITMUX is in Custom Mode.

Place a checkmark in “Enable Audio” to hear the audio from that channel. Remove the checkmark to disable audio, but this will only effect audio operation while in Custom Mode.

If your adjustments result in distortions in the channel and you want to start from scratch, click on “**Default Size/Pos**” button. The channel resolution will either change to a full screen display at the native resolution for that channel, or to a combination of the native resolution and the set output resolution of the SPLITMUX. If the output resolution is set smaller than the channel (source) resolution, then the resulting display image will be limited by the size and aspect ratio of the output setting.

For a specific display dimension for the selected channel, enter the desired values under “Width” and “Height”.

Enable/Disable Channels

You can enable or disable each channel being displayed, and provide labels for the channels. These labels are displayed in this interface as well as on the display device when “UMD” (under monitor display) is selected for the channel.

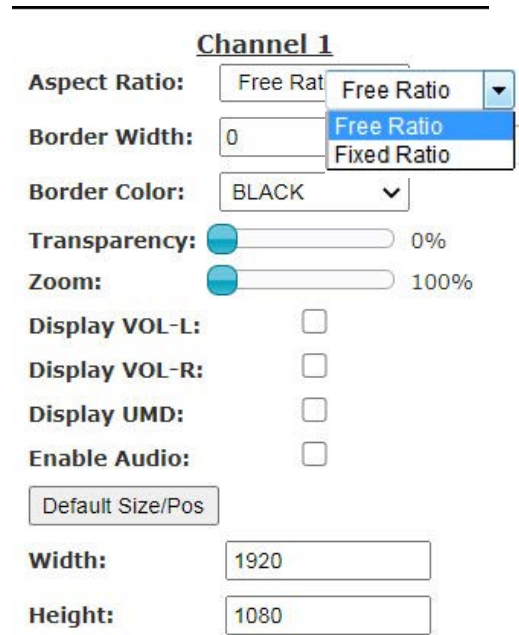

Save/Restore Layouts

Any customized layout can be saved as a preset. Once you have the desired layout settings, click on “Download” and save the layout file to a location on your PC.

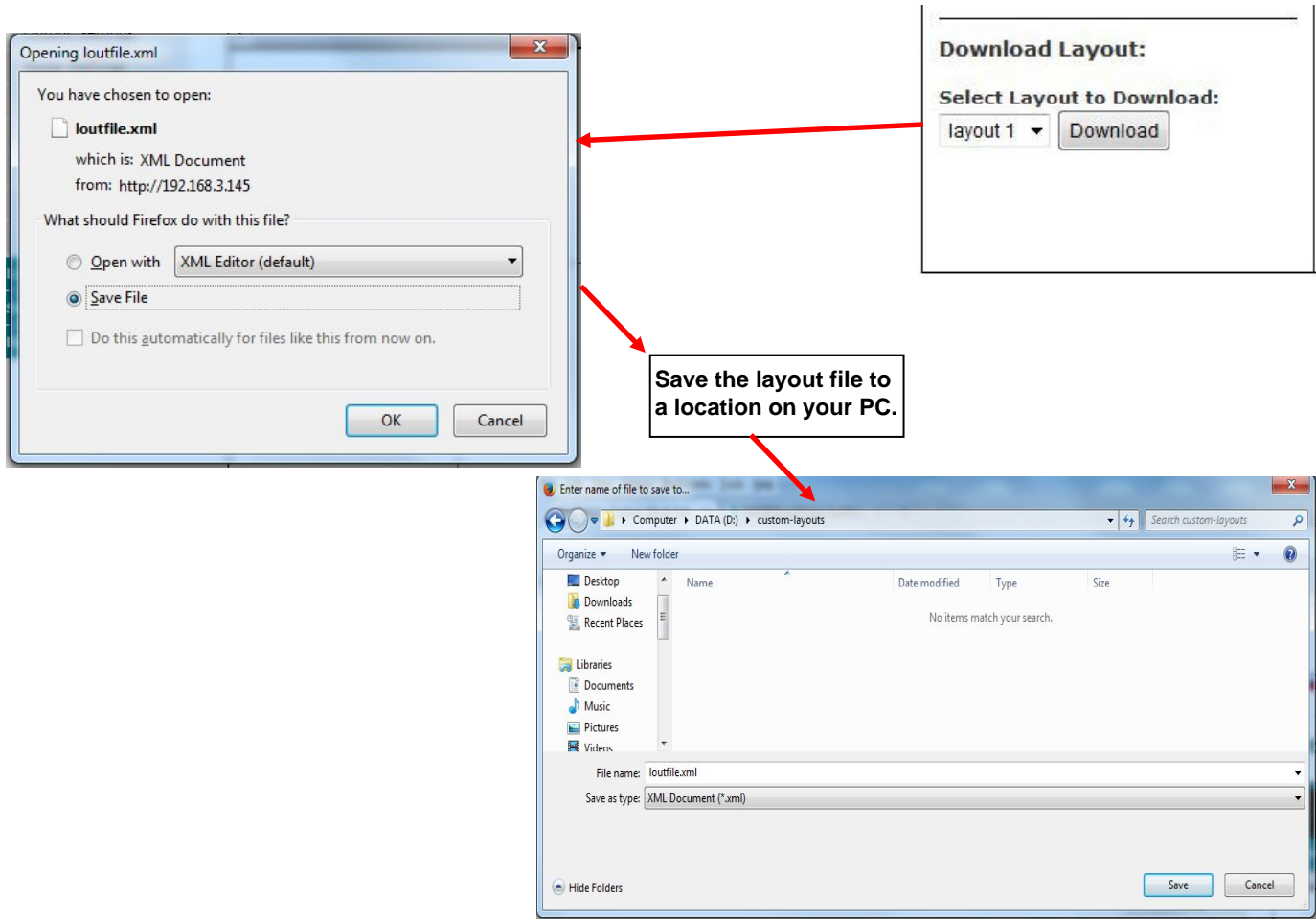

To replace an existing preset with your custom preset, click on “Browse” under “Update Layout” and select the saved preset file on your PC. Then select which preset layout to update with your custom layout and click on “Update”.

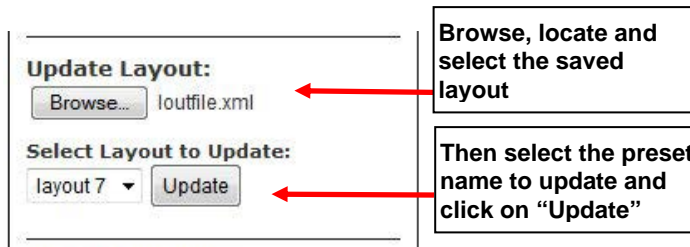

Note: If you don't want to overwrite an existing preset, save that layout to a file on your PC before updating the preset layout with your custom one. This way you can easily restore the preset at any time.

When resetting the SPLITMUX to default settings, all factory defined presets will be restored. Be sure any customized layouts are saved to your PC before resetting to defaults.

Cascade Settings

In order to expand the number of video inputs that can be monitored by one display, SPLITMUXs can be connected in a cascaded configuration.

To cascade SPLITMUXs, simply connect the output port of any downstream SPLITMUXs to the input port of an upstream SPLITMUX. Any input sources will be viewable from the monitor connected at the most upstream SPLITMUX. Using Cascade Settings under Administration, configure the SPLITMUX for the connection method that will be employed.

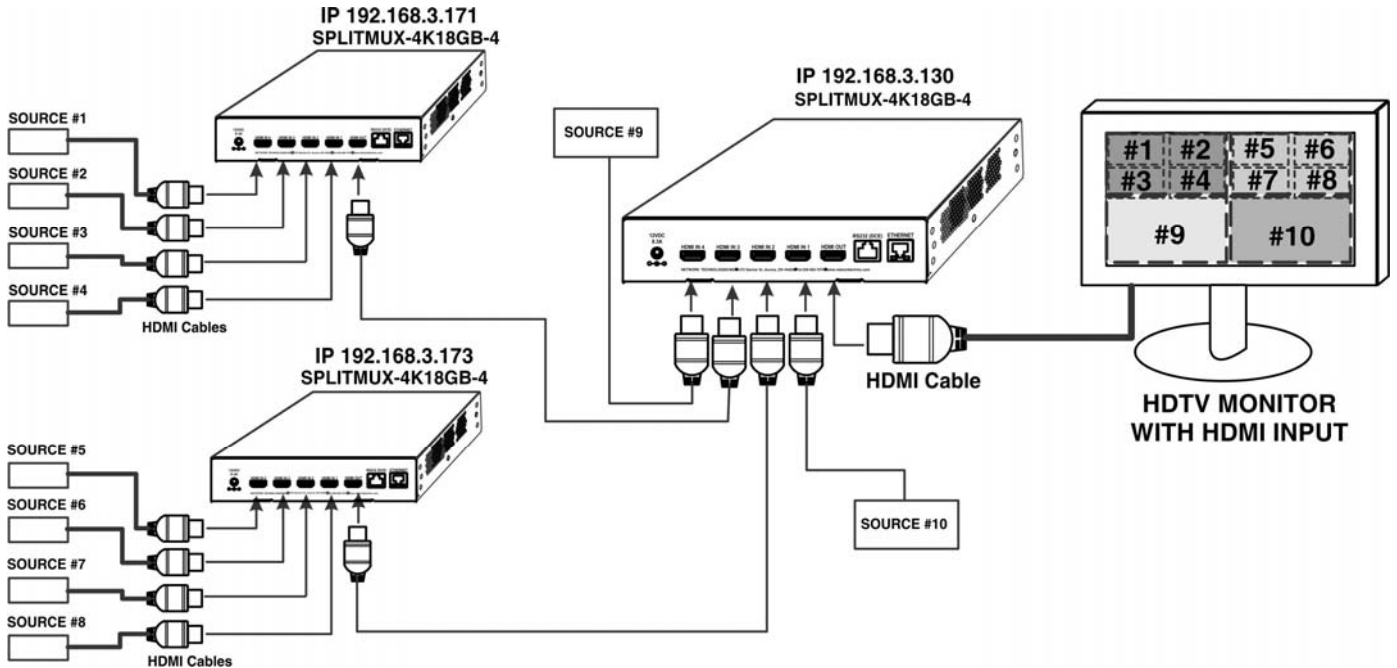

Figure 24- Cascading SPLITMUXs

Cascade Settings

Cascade Configuration	
Output type	Direct
Output IP Address	Output connection type Output master IP address for cascade
Input 1 type	Direct
Input 1 IP Address	Input 1 connection type Input 1 IP address for cascade
Input 2 type	Cascade Slave
Input 2 IP Address	Input 2 connection type 192.168.3.171 Input 2 IP address for cascade
Input 3 type	Cascade Slave
Input 3 IP Address	Input 3 connection type 192.168.3.173 Input 3 IP address for cascade
Input 4 type	Direct
Input 4 IP Address	Input 4 connection type Input 4 IP address for cascade
Save	

Figure 25- Cascade Settings

Cascade Configuration	Description
Output type	Direct- port will be directly connected to a display Cascade Slave- port will be connected to the Input port of an upstream SPLITMUX
Output IP Address	When the Output is connected to another SPLITMUX, enter the IP address of that SPLITMUX
Input X (1-4) type	Direct- port will be directly connected to a source Cascade Slave- port will be connected to the Output port of a downstream SPLITMUX
Input X IP Address	When the Input is connected to another SPLITMUX, enter the IP address of that SPLITMUX

Be sure to click on “Save” after changing these settings.

Notes:

Each SPLITMUX must be properly configured in the cascade settings in order to view the inputs at the master level.

The Custom Mode layout will display the custom mode layout outline of each slave connected to it.

The Current Mode setting of the slave will determine what video is viewed and audio is heard at the master level, regardless of what the custom mode layout is set at.

The configuration menu for each slave is accessible from the web interface of the master SPLITMUX with a proper cascade configuration.

To adjust the custom layout settings for a slave, you must be at the IP address of that slave.

The dotted lines in the custom layout are indication of connection to a slave on that channel of the SPLITMUX. To access that slave, double-click on the channel image. Allow a few seconds for the screen to update. You will see that the IP address in the URL bar has updated.

In order to control the configuration of any slave unit from the web interface, that unit must be connected to the LAN through the Ethernet port. If web interface control is not required for a slave unit, connection to the Ethernet is not required in order to use it in a cascaded configuration.

With a proper cascade configuration at each level, the IP hierarchy will be displayed in tabs on the Custom Mode Settings page.

For an example of cascading, see page 74.

Administration-User Config

Selection of this menu will display a list of all configured users and their status, including the name, if they are enabled to access the SPLITMUX and if they have basic, potentially limited, user privileges or full administrative privileges.

Click on “Add new user” to configure up to 15 users beyond the “root” user for a total of 16 users.

Users

Users				
Num.	Username	Enabled	Admin	Action
1	root	yes	yes	Edit
2	user1	yes	no	Edit Delete

[Add New User](#)

Configure User

Account Settings

Username
The username for this user

Admin
Grant this user administrative privileges

Enabled
Users can only access the system if their account is enabled

Password
The user's password to login to the system (for local authentication)

Confirm
Confirm the entered password

Title
The user's title within the company

Department
The user's department within the company

Company
The name of the user's company

FYI: Only user “root” can change the password for user “root”. An administrative user can edit any other user’s password, except for user “root”.

Figure 26- User Configuration

Account Settings	
Username	name the user will use to login
Admin	grant this user administrative privileges or not
Enabled	enable or disable this users access to the SPLITMUX Note: a user that is not enabled will not be able to log in to the SPLITMUX
Password	enter a password for this user to login with
Confirm	re-enter the password this user will login with
Title	Title of this user in the company
Department	Department of this user
Company	Name of this user’s company

To edit a user’s settings, click on the user name within the list. The “root” username and privileges cannot be changed, but the root password can be edited. If the root password is changed and forgotten, contact NTI to provide instruction to reset the password back to “nti”.

Administration- Firmware

The Update Firmware page is used to change the firmware of the SPLITMUX. Occasionally new features or changes to existing features will be introduced and new firmware with these changes will be made available on the NTI website (<https://www.networktechinc.com/4k60hz-hdmi-multiviewer.html>). To view the Update Firmware page, select **Firmware** in the **Administration** section of the main menu. Once a user has downloaded the required file for firmware upgrade, this page will be used to upload it to the SPLITMUX.

Update Firmware

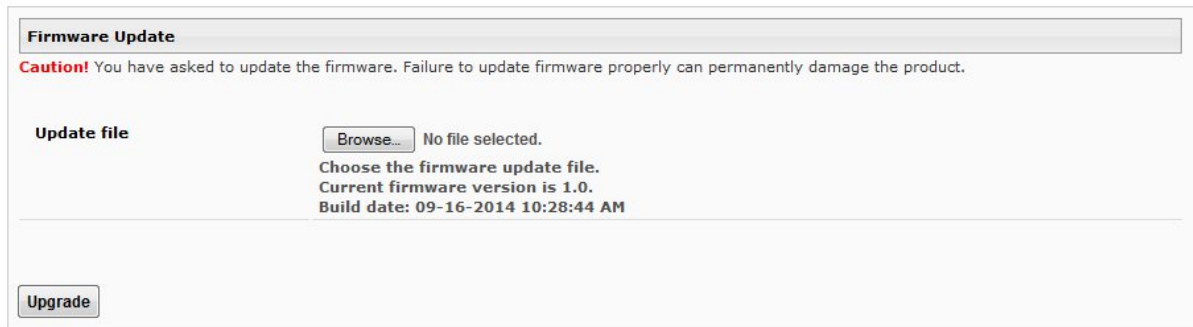
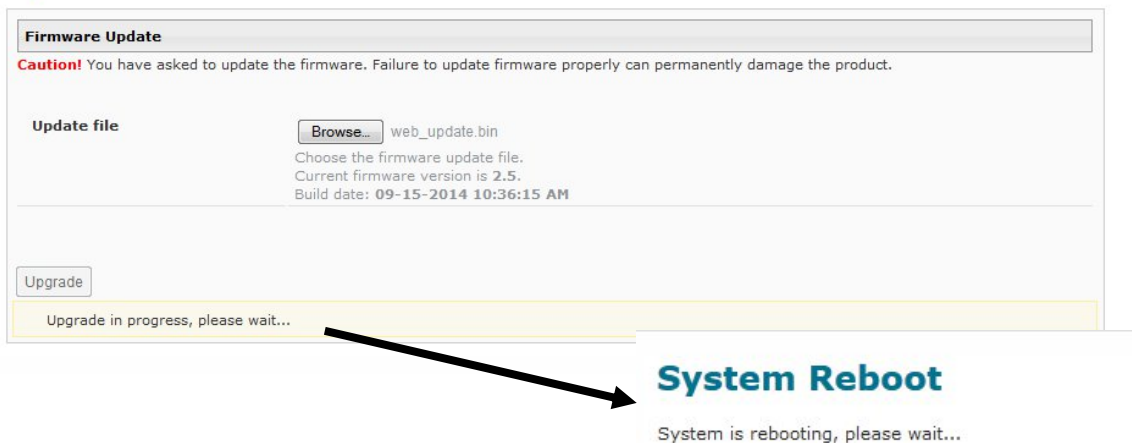

Figure 27- Firmware Update

1. Download the most current firmware file from www.networktechinc.com/download/d-hdmi-multiviewer.html to a location on your PC.
2. Click on the “Browse” button and locate and select the firmware file for the SPLITMUX (*splitmux-hd-4rt-vx-x.bin, for example*).
3. Click on the “Upgrade” button to perform the firmware update. The firmware update process will take approximately 5 minutes while the SPLITMUX installs the firmware.

Once the update file has been installed, the unit will automatically reboot. Wait for the SPLITMUX to finish rebooting (5 minutes). Then click on any menu item and the login screen will appear. Login as normal and resume operation.

Update Firmware



Note: In the event the SPLITMUX firmware should be corrupted, such that connection through the web interface is no longer possible, contact NTI for instruction and recovery files to access the SPLITMUX and restore the firmware using a TFTP server and Terminal connection (page 9).

Administration- System Information

The System Information page provides firmware version, MAC address, network settings and input connection status for the SPLITMUX. This information is particularly helpful when the IP mode is set to “DHCP With Failover” (the default setting) because it displays the DHCP server-assigned settings, regardless of the network setting applied on the Network Configuration page (page 20) which only apply when the IP mode is set to “Static”.

System Information

System Information	
Product:	SPLITMUX-4K-18GB : Quad Screen Multiviewer
Revision:	1.0
Build Date:	04-30-2021 06:00:33 PM
MAC Address:	16:0F:02:23:3D:66
IP Mode:	DHCP With Failover
IP Address:	192.168.3.130
Subnet Mask:	255.255.255.0
Default Gateway:	192.168.3.3
Primary DNS:	166.102.165.11
Secondary DNS:	8.8.8.8
Output Resolution:	auto, Non-Encrypted Video, Non-HDCP Monitor
Input1 Status:	Non-Encrypted Video, 28x2i
Input2 Status:	Encrypted Video, 3840x2160
Input3 Status:	Encrypted Video, 1920x1080
Input4 Status:	Non-Encrypted Video, 5x0

Figure 28- System Information page

Note: The System Information page always shows the assigned IP address whether the IP Mode is set to “Static” or “DHCP with Failover”. (See page 20) This information is also easily accessed from the OSD screen using the front panel buttons.

Logout

To logout of the SPLITMUX, click on the Logout link in the left menu. This will return you to the login screen.

Mode
Administration
Logout
Logout
Support
Reboot

Support

The Support section of the menu includes two links, Manual and Downloads.

The Manual link will open the pdf manual for the SPLITMUX on the NTI website. You must have Adobe Reader installed on your computer to open this.

The Downloads link will take you to the Firmware Downloads page for the SPLITMUX on the NTI website. All versions of firmware for the SPLITMUX will be found there, available for immediate download to your computer.

Mode
Administration
Logout
Support
Manual
Downloads
Reboot

Reboot

To remotely cause the SPLITMUX to reboot and refresh, click on "Reboot" under "Reboot" in the side menu.

The SPLITMUX will immediately log any users out and reboot. Another click on anything in the side menu will return you to the login screen.

The screenshot shows a side menu on the left with the following items: Mode, Administration, Logout, Support, Reboot, and Reboot. The 'Reboot' item is highlighted. The main content area displays the title 'System Reboot' and the message 'System is rebooting, please wait...'.

COMMAND LINE INTERFACE

The SPLITMUX can be controlled using a command line interface from either a terminal connection to the “RS232” serial port (page 9) or through an Ethernet connection (page 9).

RS232 Control

The RS232 Interface is designed to meet the RS232C standard and can be controlled from any CPU or other controller with an RS232 communications port. The pin-out for the RJ45 connector on the unit is as follows:

RS232 (RJ45) CONNECTOR

PIN	SIGNAL	FUNCTION
1	-	No connection
2	-	No connection
3	RX+	Receive data (TXD at host)
4	GND	Ground
5	-	No connection
6	TX+	Transmit data (RXD at host)
7	-	No connection
8	-	No connection

A 5 foot patch cable and adapter, RJ45-to-DB9, have been provided for connection to most CPUs (see page 9).

Baud Rate

The baud rate can be changed using the OSD menu (page 60), using Telnet commands (page 40) from the RS232 commands (page 39), from the Text Menu (page 44), or through the WEB Interface (page 18). The baud rate can be set to 115200, 57600, 38400, 19200, 9600, 4800, 2400, or 1200. A data protocol of 8 data bits, no parity, and 1 stop bit is used for communications. The default baud rate setting is 115200. The terminal should be in VT100 terminal mode.

RS232 Command Protocol

CPU controller commands supported by the unit are defined below. All commands must be terminated with a <CR> (carriage return). When a command is sent, the entire string is echoed back along with a response from the addressed unit as shown in the Command Definitions table (below). All characters in the command string are case sensitive (see Command Definitions table), and all numbers below 10 must have a leading 0 (ex: 1 = 01).

Legend:

(All numbers must be two digits)

SA	:	Serial Address (01-15)	<CR>	:	Carriage Return (Hex 0xD)
BR	:	Baud Rate Code	mode	:	01 = FULL, 02 = QUAD, 03 = TRIP, 04 = PIP, 05 = CUSTOM
ip	:	Input Port (01-04)	nn	:	Custom Layout (01-10)

Command Definitions

Command String	Good Response	Description
CS SA,ip,01	*<CR>	Connect input X to the output port
CM SA,mode,01	*<CR>	Change the mode of the switch
CF SA	Login Prompt	Open Text Menu
CB 00,BR	None	Change baud rate of serial line, BR=11(5200),57(600),38(400),19(200)96(00),48(00),24(00),12(00) Factory default is 115200
LA SA,nn	*<CR>	Load saved custom layout (01-10)
RU SA	*<CR>IP,OP<CR>	Read Unit Size
RS SA	*<CR>	Reset unit

If the first field is not a known command (as listed above) or SW field is different from the serial address programmed in the switch memory, the command will be ignored. If the SW field corresponds to the unit address, but the syntax is wrong after this field, the switch will answer with a bad response ?<CR>.

Examples:

(From the screen in the Terminal program (HyperTerminal, Putty, etc))

Type, then press <Enter>	Action
RU 01	This will return the unit size. RU must be in upper case. There is a space (press the <Spacebar>) between RU and 01. 01 is the default serial address of the unit.
CS 01,02,01	This will connect input 2 to output 1. The first 01 is unit serial address; 02 is input 2; the last 01 means output 1. (There is only 1 output, so this value will always be 01). There is a space between letters and numbers, but a comma between just number values.
CM 01,03,01	This will change output mode to PIP. The first 01 is the serial address. Change as needed for the SPLITMUX you are controlling. 03 is the mode setting desired (PIP). The second 01 means output 1.
CF 01	This will bring up the Text Menu for the SPLITMUX with serial address 01. Text menu functions begin on page 41.

Telnet Control

To control the SPLITMUX using telnet from the command line, the SPLITMUX must first be connected to the Ethernet.

Note: Telnet must be enabled through the web interface (page 20) for a connection via Telnet to be possible and the user must be on the same subnet as the SPLITMUX.

To open a telnet session to the SPLITMUX, issue the following command from the command line:

```
telnet <SPLITMUX IP address> 2000
```

<SPLITMUX IP address> is IP address of the SPLITMUX (default is **192.168.1.30**).

Note: When making a Telnet connection through any terminal software, be sure to configure to connect through port 2000.

The user will be prompted for the root password to connect to the SPLITMUX.

The factory default password is "nti". (all lowercase letters).

With a proper password sent the SPLITMUX will respond with:

Password Successful
Connection Established

The commands below are now usable:

Command String	Good Response	Description
CS, <i>ip</i> ,01	*<CR>	Connect input X to the output port
CM, <i>mode</i> ,01	*<CR>	Change the mode of the switch
CF	Login Prompt	Open Text Menu
CB 00, <i>BR</i>	None	Change baud rate of serial line, BR=11(5200),57(600),38(400),19(200)96(00),48(00),24(00),12(00) Factory default is 115200
LA, <i>nn</i>	*<CR>	Load saved custom layout (01-10)
RU	*<CR> <i>IP</i> , <i>OP</i> <CR>	Read Unit Size
RS	*<CR>	Reboot unit

USING THE TEXT MENU

The text menu can be reached either by using a serial command through the RS232 port or a Telnet command through an Ethernet connection. Either way, a text menu with full feature control can be reached by any administrative user.

Text Menu Navigation

- To move up and down the numbered menu items or toggle through field options, use the arrow keys.
- To jump from menu item to another quickly, press the numbered key above the QWERTY keys (**the numberpad number keys are not used**).
- To move from menu list to action key (such as “Save” in Figure 31), press <Tab>.
- To exit an action or menu, press <Esc>.
- To select a highlighted item or move to another field in a configuration page, press <Enter>.
- Be sure to Tab to “Save” and press <Enter> when configuration changes are made.
- To return from “Save” back to a field on the configuration page, press <Tab>.

From a terminal connection to the “RS232” port, enter the command “CF SA” (where SA is the serial address of the SPLITMUX) and press <Enter>.

From an Ethernet connection through the LAN, enter the Telnet command “CF” (provided you already have a Telnet connection as described on page 40) and press <Enter>.

You will be presented with a login screen.

1. At “Username” type <root> (all lowercase letters) and press <Enter>.
2. At “Password” type <nti> (all lowercase letters) and press <Enter>.

If you are an administrative user, alternatively enter a valid username and password to also access this menu.

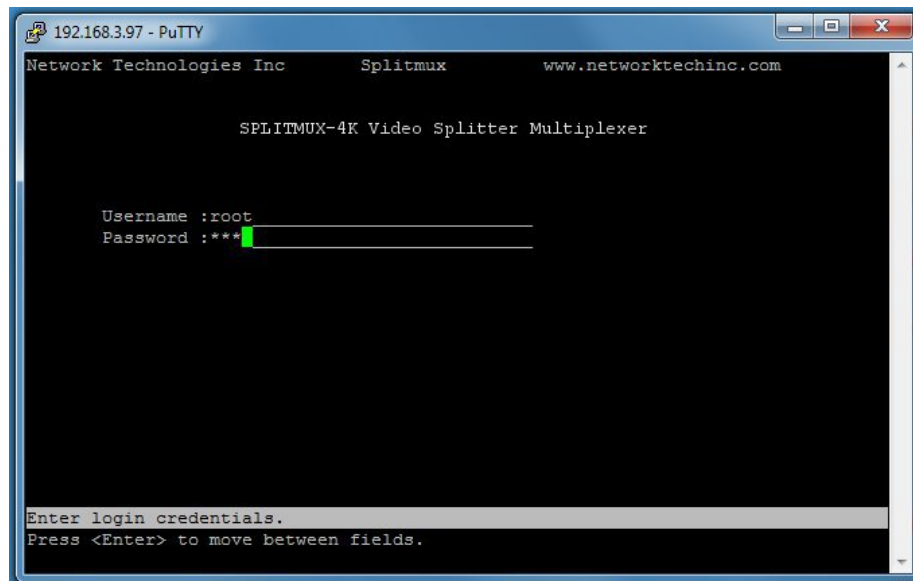

Figure 29- Text Menu- Login screen

Note: User names and passwords are case sensitive. It is important to know what characters must be capitalized and what characters must not.

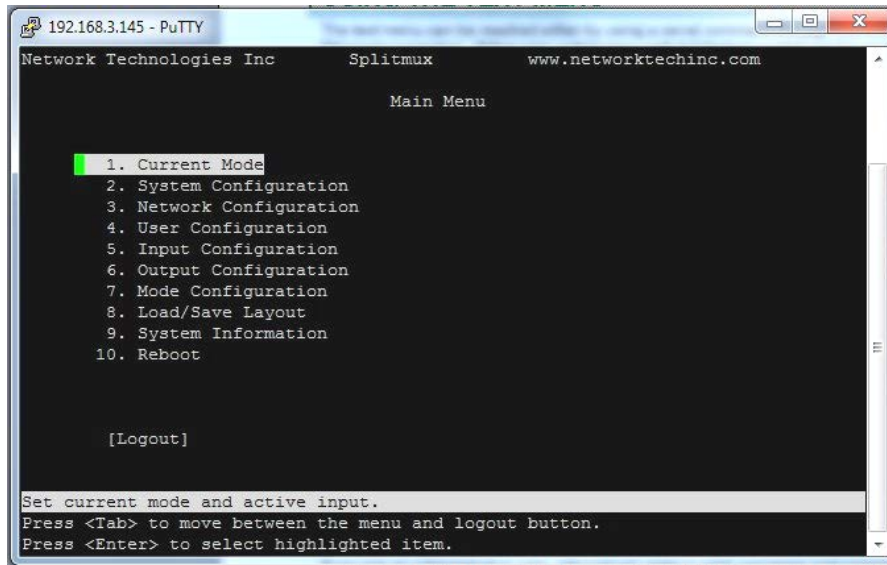

Figure 30- Text Menu-Main Menu

The Main Menu is broken into 10 categories:

Function	Description
Current Mode	Sets the current viewing mode of the SPLITMUX
System Configuration	Configure system settings
Network Configuration	Configure network settings
User Configuration	Configure user access settings
Input Configuration	Configure which inputs will be viewed
Output Configuration	Configure how the images will appear on the display
Mode Configuration	Configure how each mode will behave
Load/Save Layout	Choose to save custom layout (up to 10 different layouts) or load one of saved custom layouts.
System Information	Displays information about the configuration of the SPLITMUX
Reboot	Enables the user to reboot the SPLITMUX

Current Mode

In the Current Mode screen (Main Menu-> 1), set the active mode of the SPLITMUX. This is the mode the SPLITMUX will be in if the unit is power-cycled. The selected Current Active Input will be the primary input (i.e. when in PIP mode, this will be the largest image on the screen at power ON).

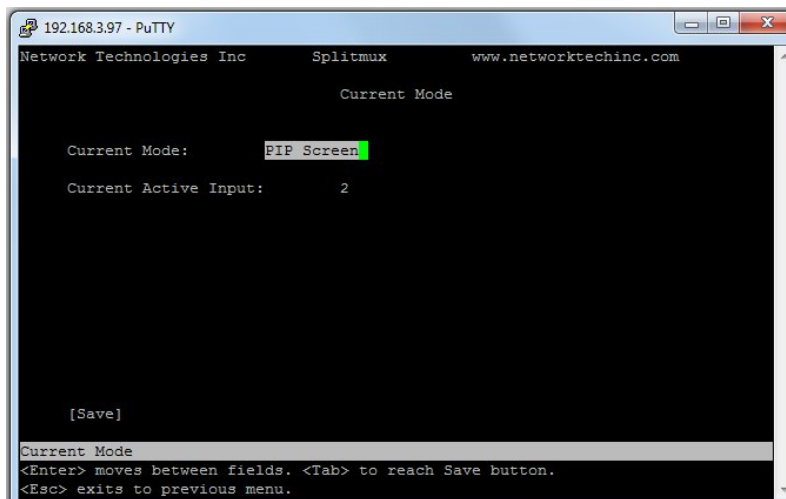

Figure 31- Text Menu-Current Mode Selection

System Configuration

In the System Configuration screen (Main Menu—>2) provides 3 categories of settings to configure, and provides an option to restore the SPLITMUX configuration to default settings.

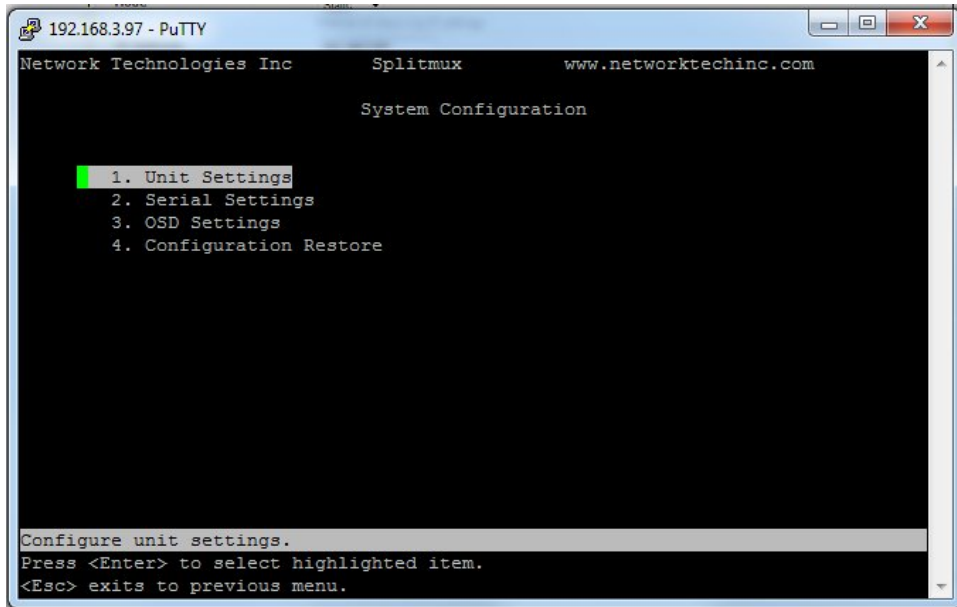

Figure 32- Text Menu- System Configuration

The Unit Settings page provides a place to enter the name as you want it to appear in the web interface.

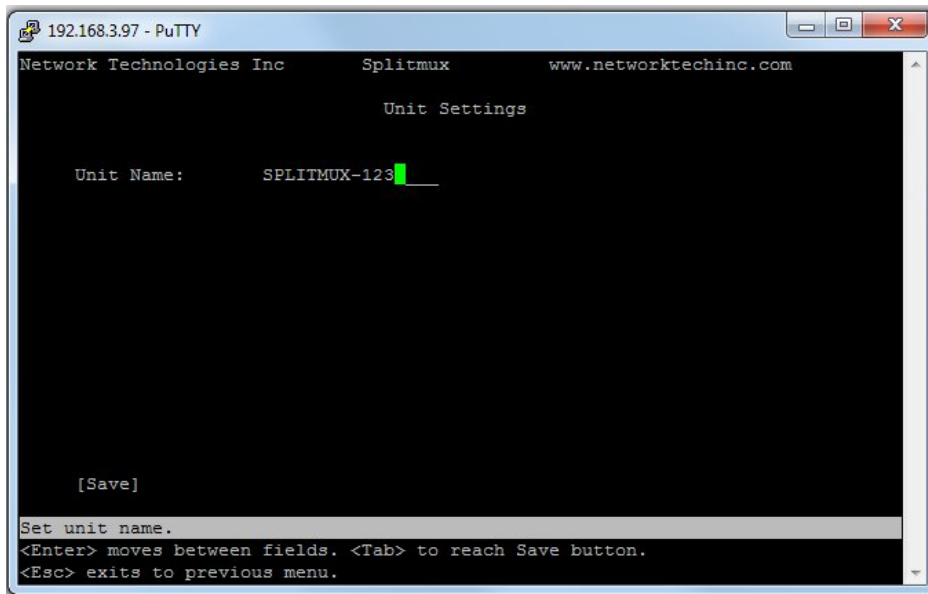

Figure 33- Text Menu- Unit Settings

Serial Settings page provides configuration of the baud rate (select a value between 1200 and 115200 bps) and the assigned serial address (1-15).

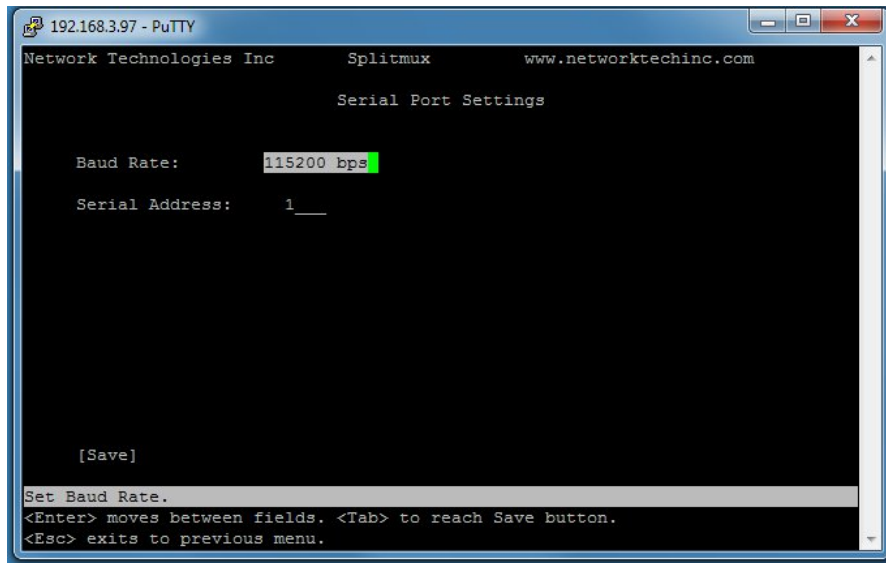

Figure 34- Text Menu- Serial Port Settings

The OSD Screen Settings page provides values for the placement of the OSD menu on your screen. Values of the Horizontal and Vertical Position offsets are in percentage of the screen and range from 0 to 70%.



Figure 35- Text Menu- OSD Screen Settings

If item 4 is selected from the System Configuration menu, you will be prompted for a “Yes” or “No” selection as to whether you are sure you want to reset all settings in the SPLITMUX to default values, or not. Be careful here, but the default answer is “No” for your protection.

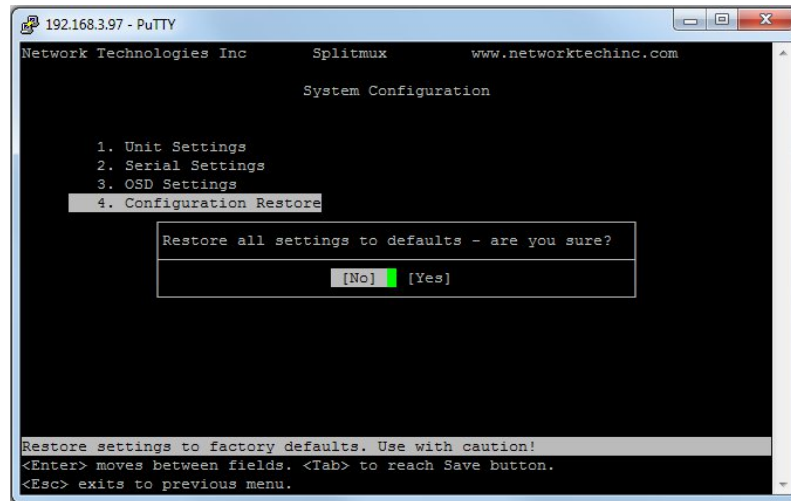

Figure 36- Text Menu- Restore Default Settings

Network Configuration

The Network Configuration screen (Main Menu—>3) is where all network settings are entered. These settings determine how you will remotely access the SPLITMUX. Choose between your basic network (IP) settings and several server settings.

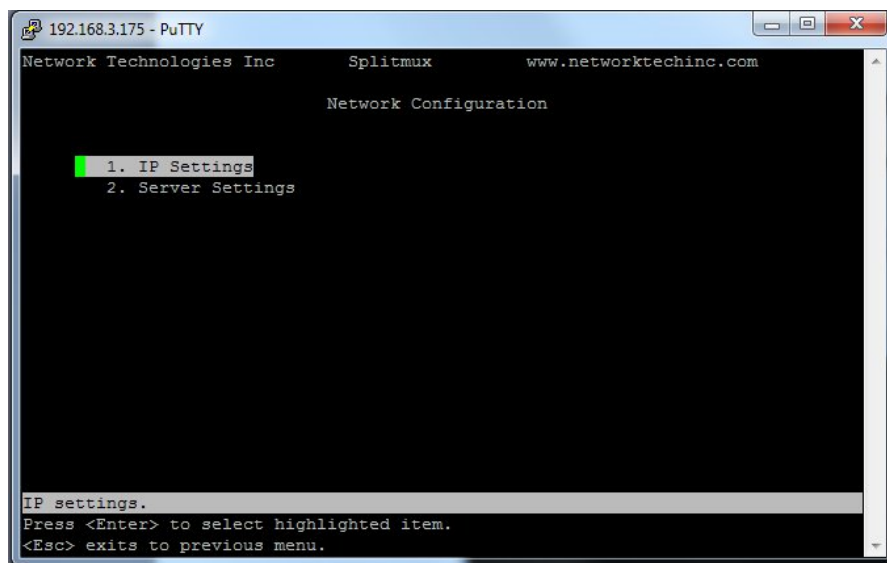

Figure 37- Text Menu- Network Configuration

The main network settings required to connect the SPLITMUX to your network are found under IP Settings.

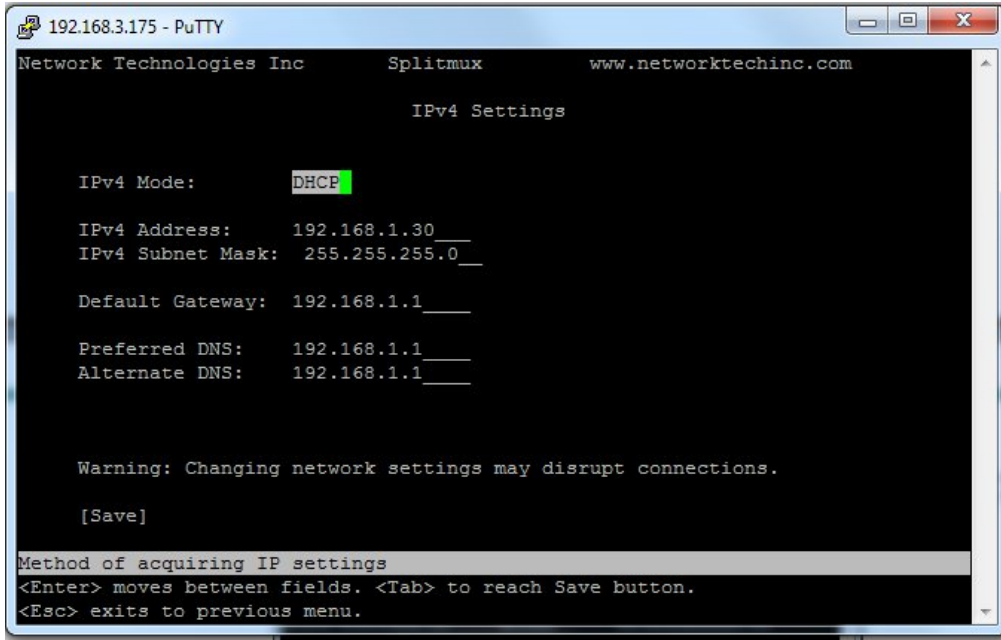

Figure 38- Text Menu- IPv4 Network Settings

(Default settings are shown in this image)

IP Settings	
Mode	Select the method for acquiring IP Settings- Static (manual), DHCP (automatic) or Disable
IP Address	Enter valid IPv4 address (for Static Mode) (default is 192.168.1.30)
Subnet Mask	Enter valid subnet mask (for Static Mode)
Default Gateway	Enter valid default gateway (for Static Mode)
Primary DNS Address	Enter preferred name server (for Static Mode)
Alternate DNS Address	Enter alternate name server (for Static Mode)

Note: If you select “DHCP” for the mode, make sure a DHCP server is running on the network the SPLITMUX is connected to.

If, upon bootup, the SPLITMUX does not find a DHCP server, the SPLITMUX can be accessed using its default IP address and network settings (above).

Note: The IP address shown here is only used when the IPv4 mode is set to “STATIC”. To view the IP address when the mode is set to “DHCP”, go to the “System Information” page (page 57).

Important server settings that determine your ability to connect the SPLITMUX and stay connected are found under Server Settings.

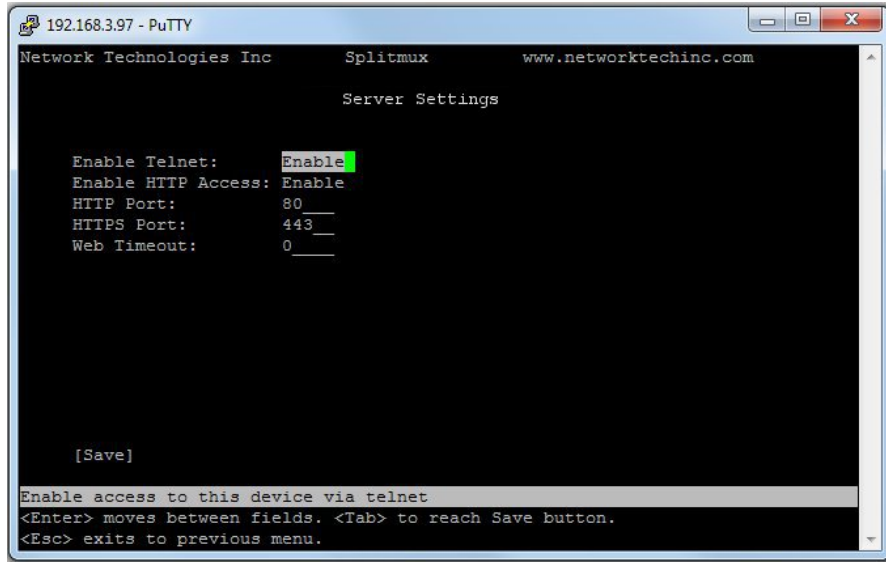

Figure 39- Text Menu-Server Settings

Server Settings	
Enable Telnet	Change to “Enable” to permit access to the SPLITMUX via Telnet The default is disabled.
Allow HTTP access	Change to “Enable” to allow access to the SPLITMUX via standard (non-secure) HTTP requests The default is disabled.
HTTP Port	Port to be used for standard HTTP requests (default is 80)
HTTPS Port	Port to be used for HTTPS (secure) requests (default is 443)
Web Timeout	Number of minutes after which idle web users will be logged-out (maximum is 32000, enter 0 to disable this feature)

User Configuration

The configured users are listed on the Configure User screen (Main Menu—>4). Up to 15 users can be configured to access the SPLITMUX (16 total including “root”). Select a user and press Enter to edit the user settings, press Tab to “Add” (User) to create a new one, or press Tab to Delete the selected user.

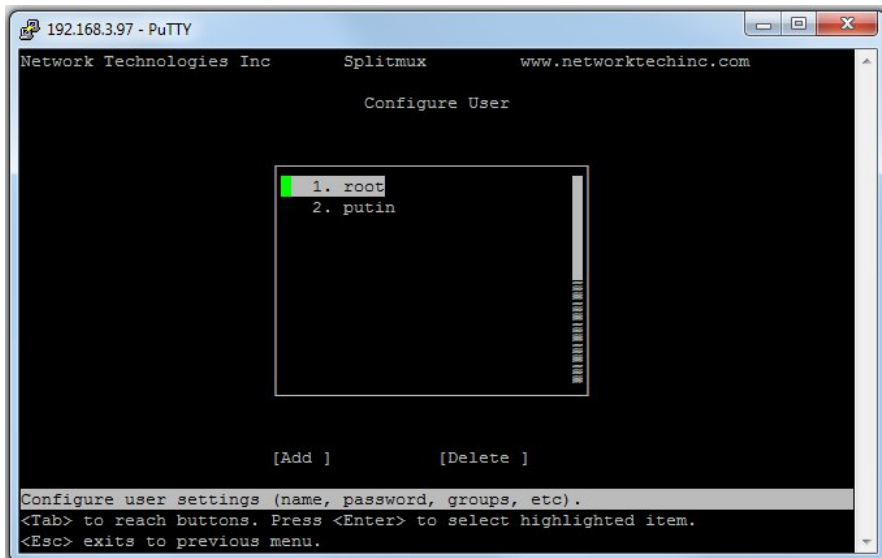

Figure 40- Text Menu- Users List

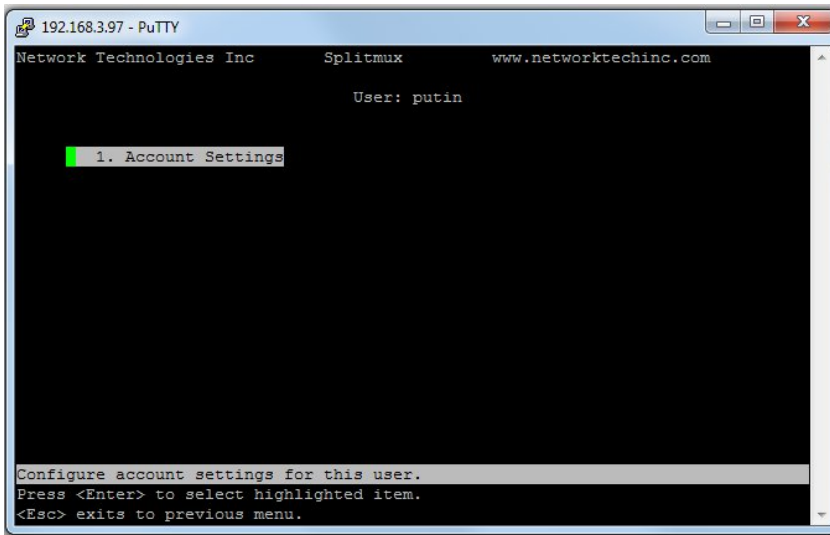

Figure 41- Text Menu- Account Settings

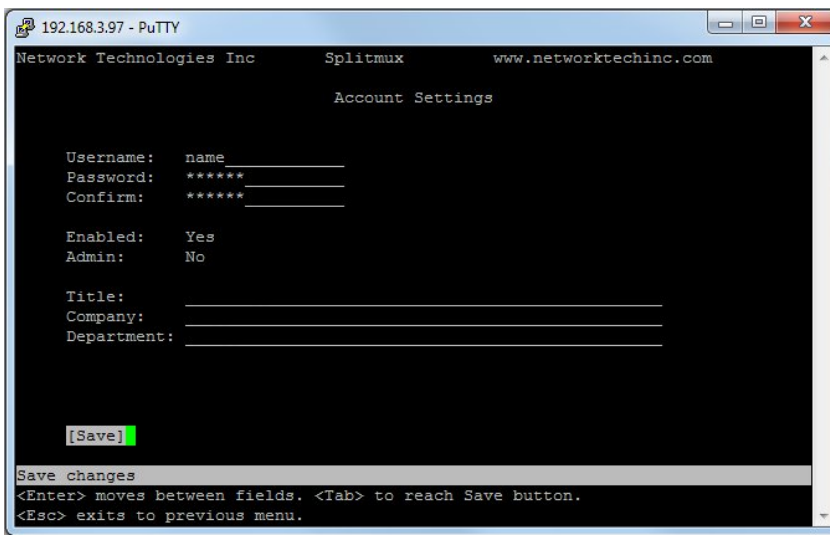

Figure 42- Text Menu- User Account Settings

Account Settings	
Username	enter the name the user will use to login
Password	enter a password for this user to login with
Confirm	re-enter the password this user will login with
Enabled	Yes or No to enable this user to access the SPLITMUX
Admin	grant this user administrative privileges - or not
Title	Title of this user in the company
Company	Name of this user's company
Department	Department of this user

Input Configuration

Configure what inputs will be viewed on the display in the Input Configuration screen (Main Menu—>5). Select which input to configure and choose the settings to be applied.

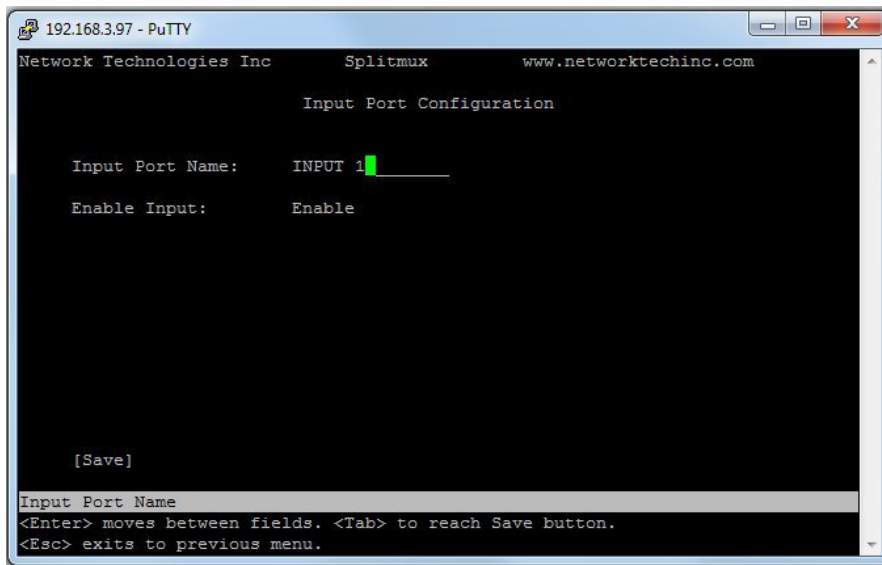
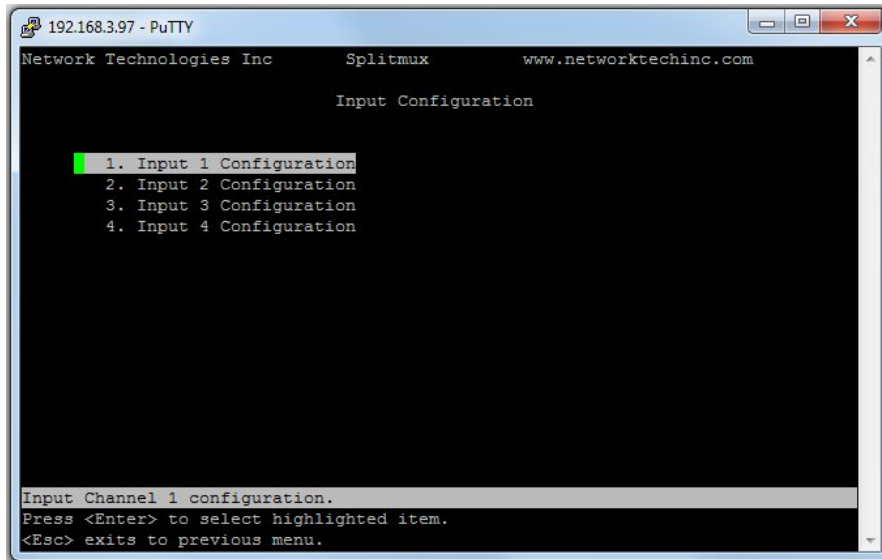

Figure 43- Text Menu- Input Configuration

Input Settings	
Input Channel x Port Name	Enter a port name to associate with the video source on Input 1
Enable	Choose to Enable or Disable the video input for this channel

Each Input channel can be configured with these settings.

Output Configuration

The Output Configuration determines how the inputs will be viewed on the display (Main Menu—>6). From this menu you can also select the Audio Output Configuration which will provide settings for how the audio from the inputs is managed.

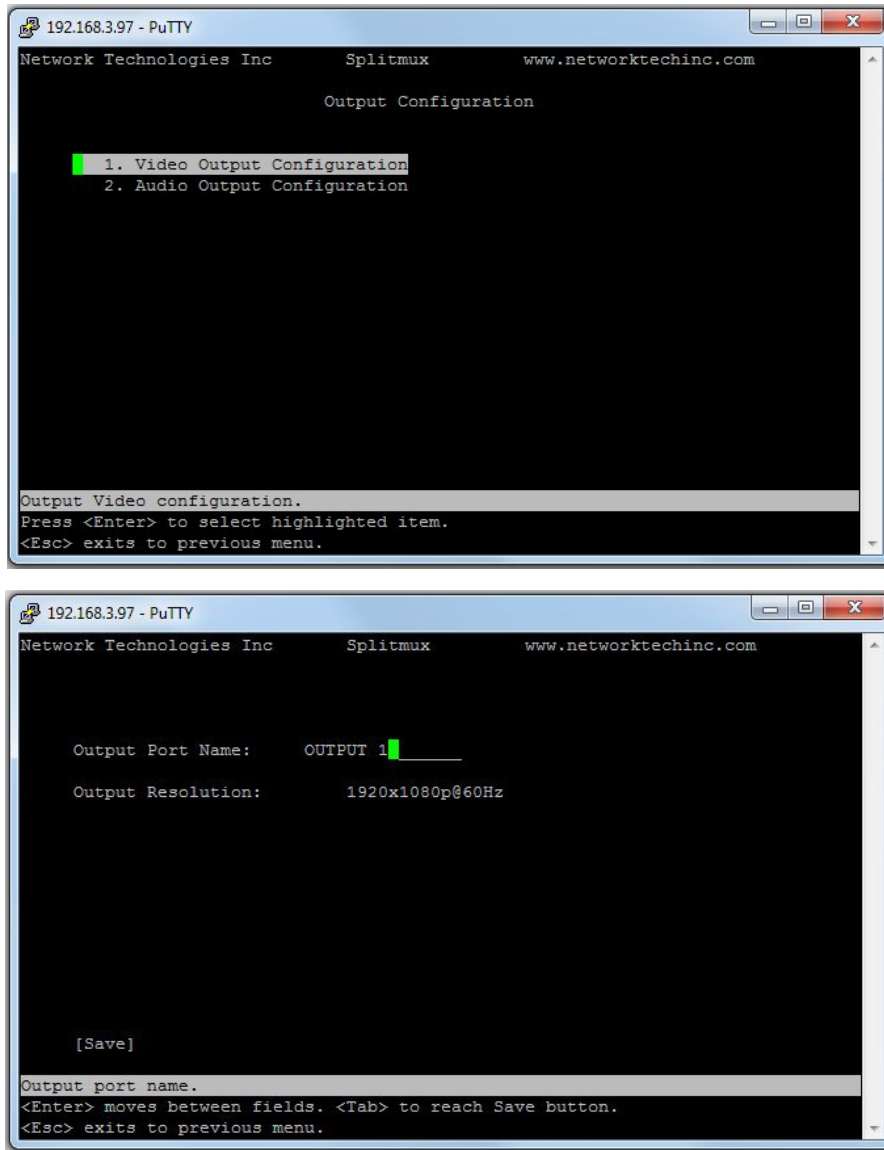

Figure 44- Text Menu- Output Configuration

Video Output Configuration	
Output Port Name	Enter a port name to associate with the display
Output resolution	Select the output resolution to send to the display (see table below for resolutions to choose from) or select "Auto" to have it choose from the EDID table.

Note: When the Output resolution is set to “Auto”, your SPLITMUX will automatically sense the native resolution of your monitor and set the output resolution to that when powering ON the SPLITMUX.

Video Output Resolutions to choose from (progressive scan):

1280x720@60Hz	2048x1080@60Hz	3840x2160@60Hz	4096x2160@30Hz
1920x1080@60Hz	3840x2160@30Hz	4096x2160@60Hz	

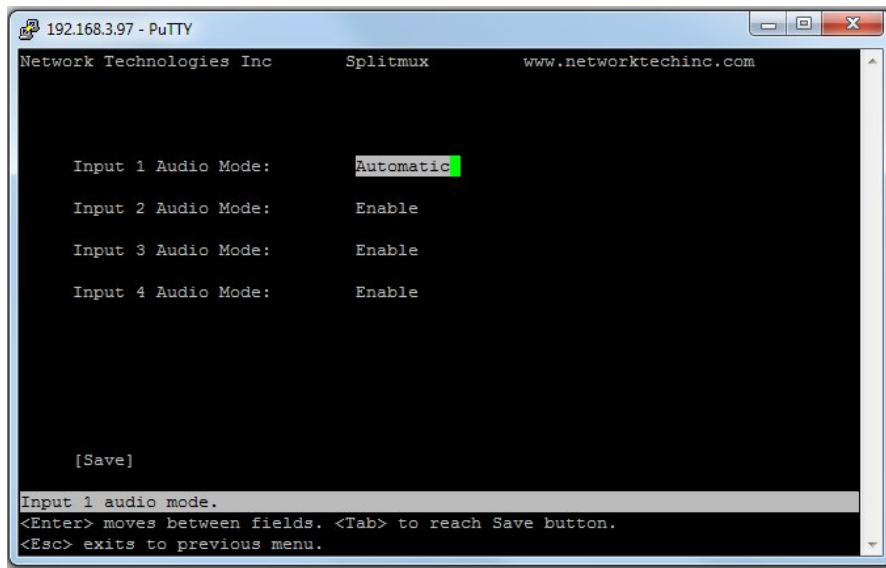

Figure 45- Text Menu- Audio Output Configuration

Audio Output Configuration	
Input 1 Audio Mode	Select the audio mode for the Input- between enabled/disabled/automatic
Input 2 Audio Mode	Select the audio mode for the Input- between enabled/disabled/automatic
Input 3 Audio Mode	Select the audio mode for the Input- between enabled/disabled/automatic
Input 4 Audio Mode	Select the audio mode for the Input- between enabled/disabled/automatic

When Audio Mode is enabled, the audio will come through any time the input signal is present (whether the video is enabled or not)

When Audio Mode is disabled, no audio will be heard from that input.

When Audio Mode is automatic, the audio will only be heard from that input if that input is the currently selected input. To avoid confusion from multiple audio inputs when using Quad, TRIP or PIP modes, set each audio input to automatic.

Mode Configuration

Mode Configuration (Main Menu—>7) will determine how each display mode provided by the SPLITMUX will be presented. Mode characteristics will determine how the images will look on the display.

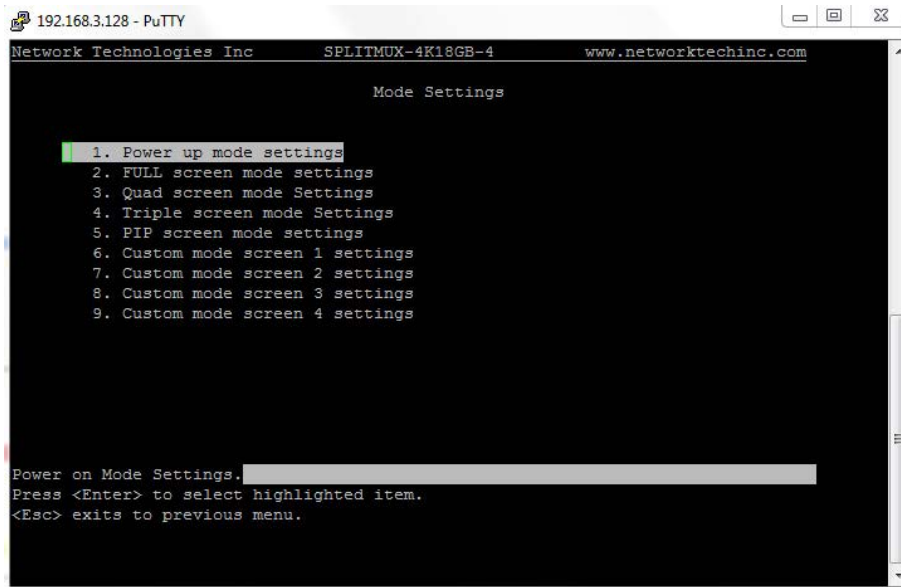

Figure 46- Text Menu- Mode Settings Menu

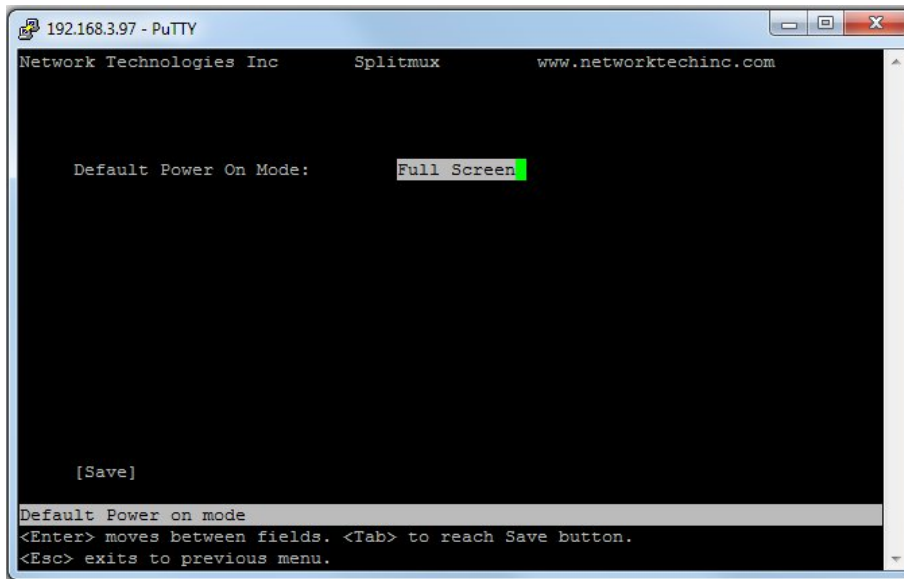

Figure 47- Text Menu- Default Mode Configuration

Power Up Mode Setting	
Default Power On Mode	Choose the default mode the SPLITMUX will be in when powered ON. Choose from Full, PIP, Quad or Custom

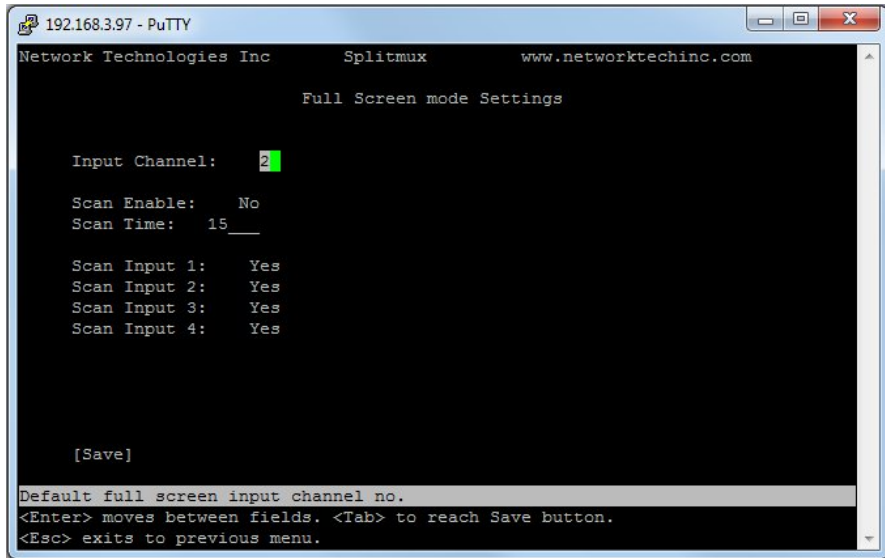

Figure 48- Text Menu- Full Screen Mode Settings

Full Screen Mode Settings	
Input Channel	Select the input channel assigned to Full Screen
Enable Scan	Enable scanning for the full screen input channel- to automatically switch from one channel to another
Scan time	Set the dwell time while scanning- the amount of time (in seconds) each channel will appear at full screen- range is 0-999
Scan input 1-4	Select Yes or No to include input 1, 2, 3 or 4 in the scanning sequence

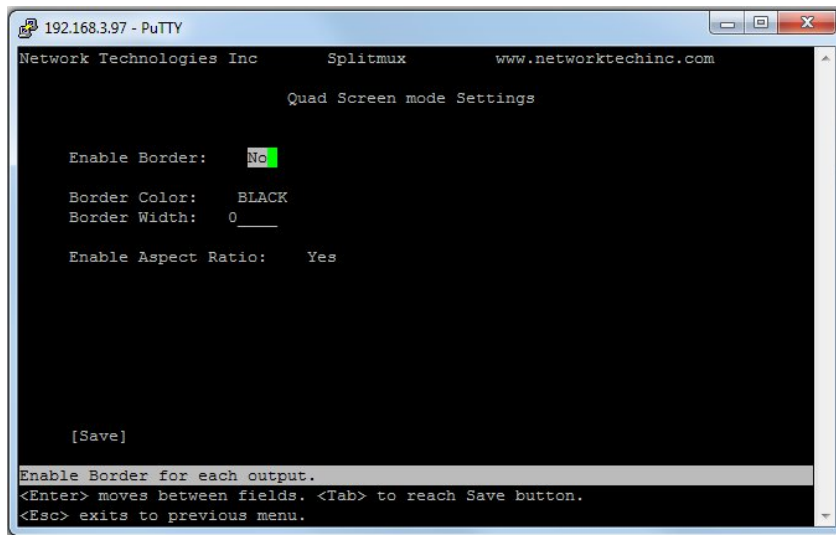

Figure 49- Text Menu- Quad Mode Settings

Quad Screen Mode Settings	
Enable Border	Choose whether or not to place a border around each input displayed
Border Color	Choose the color of the border around each input
Border Width	Choose the width of the border around each input- from 0-50 pixels
Aspect Ratio	Choose whether or not to maintain the aspect ratio for each displayed image

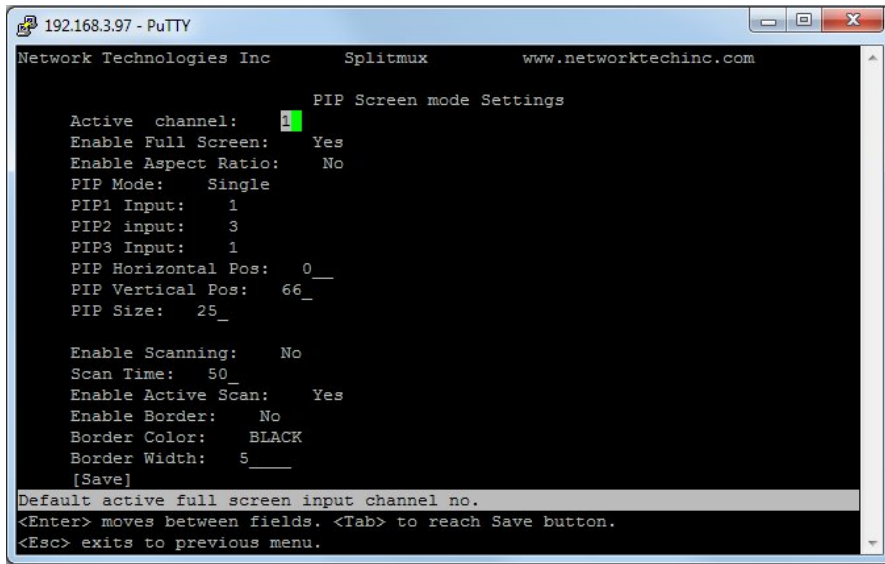

Figure 50- Text Menu- PIP Mode Settings

Pip Screen Mode Settings	
Active Channel	Select which active channel is in full screen mode
Enable full screen	Enable active input in full screen mode with overlay of PIP windows
Enable aspect ratio	Enable the aspect ratio to be maintained for all displayed images
PIP Mode	Select how many PIP images will be displayed, 2, 3 or 4 (one will be at full screen)
PIP 1 Input	Select which input channel will be in PIP upper right position
PIP 2 Input	Select which input channel will be in PIP center position
PIP 3 Input	Select which input channel will be in PIP lower right position
PIP Horizontal Position	Position of PIP images from the right side of the screen- range is 0-90% of screen width
PIP Vertical Position	Position of uppermost PIP from the top of the screen- range is 0-60% of screen height
PIP Size	Size of the PIP image- range is 10-50%
Enable Scan	Enable input channel scanning when PIP Mode is set to "Single"
Scan Time	Set the dwell time while scanning- the amount of time (in seconds) each channel will appear in the single PIP position- range is 0-999
Enable Active Scan	Enable full screen scanning between the inputs while in PIP mode
Enable Border	Place a border around each input displayed
Border Color	Choose the color of the border around each input
Border Width	Choose the width of the border around each input- from 0-50 pixels

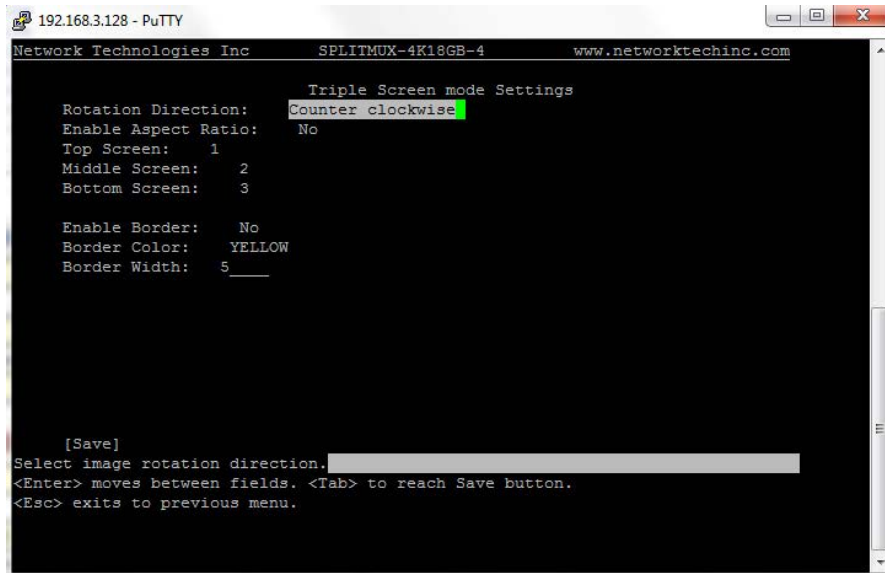

Figure 51-Text Menu- Triple Screen Mode Settings

Triple Screen Mode Settings	
Rotation Direction	Clockwise or Counter-clockwise
Enable Aspect Ratio	Yes or No to keep the input aspect ratio
Top Screen	Select which input should be displayed on top
Middle Screen	Select which input should be displayed in the middle
Bottom Screen	Select which input should be displayed on the bottom
Enable Border	Yes or No to add a border for each input
Border color	Choose the color of the border around each input
Border width	Choose the width of the border around each input (0-50 pixels) (0 = no border)

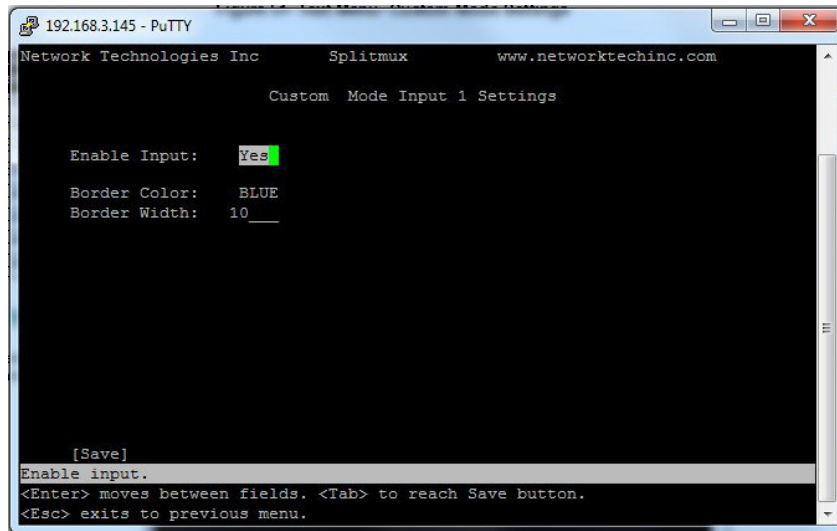

Figure 52- Text Menu- Custom Mode Settings

Custom Screen Mode Settings Input x (1-4)	
Enable Input	Enter a checkmark to enable the display of the input
Border color for Input	Choose the color of the border around each input
Border width for Input	Choose the width of the border around each input- from 0-50 pixels (0 = no border)

Load/Save Layout

Select Load/Save Layout from the main menu (Main Menu—>8) to save or recall a display configuration of video sources being viewed.

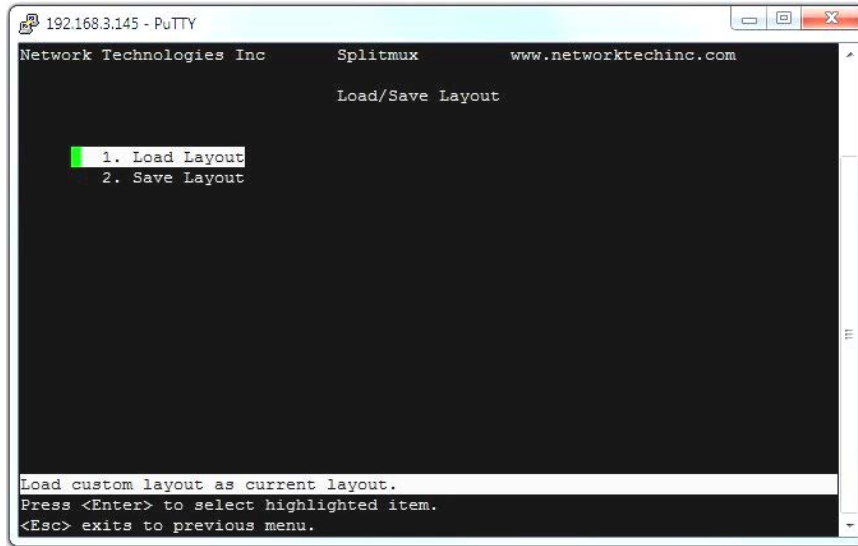
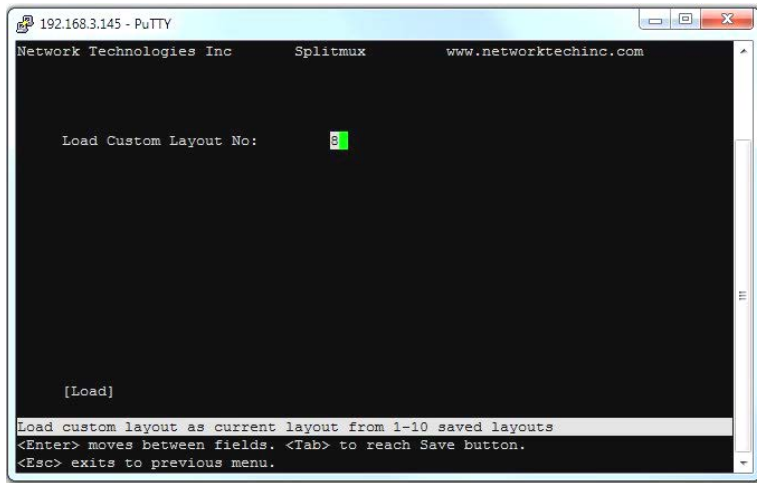
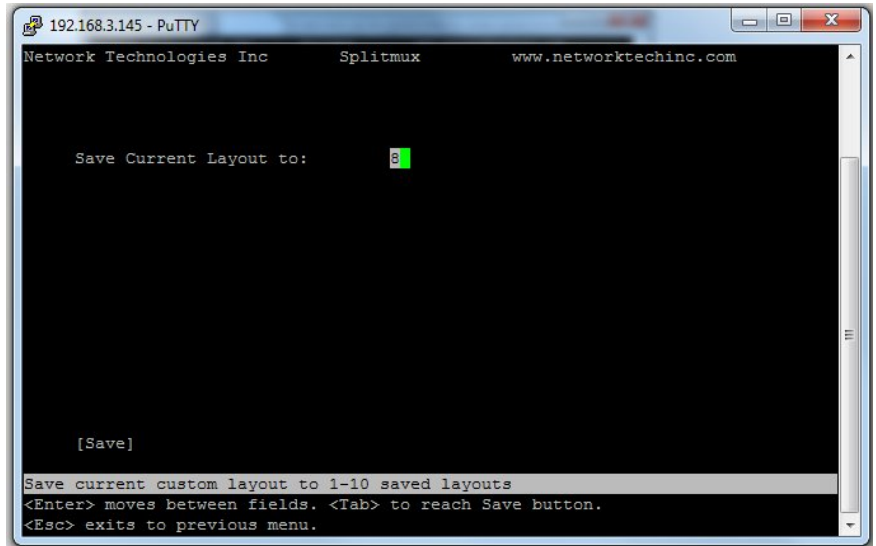

Figure 53- Text Menu- Load/Save Layout

Either save your current layout to one of 10 possible saved layouts.....



..... or load one of up to 10 previously viewed and saved layouts.

System Information

Select System Information from the main menu (Main Menu—>9) to view the port status, network configuration, firmware version and MAC address for the SPLITMUX.

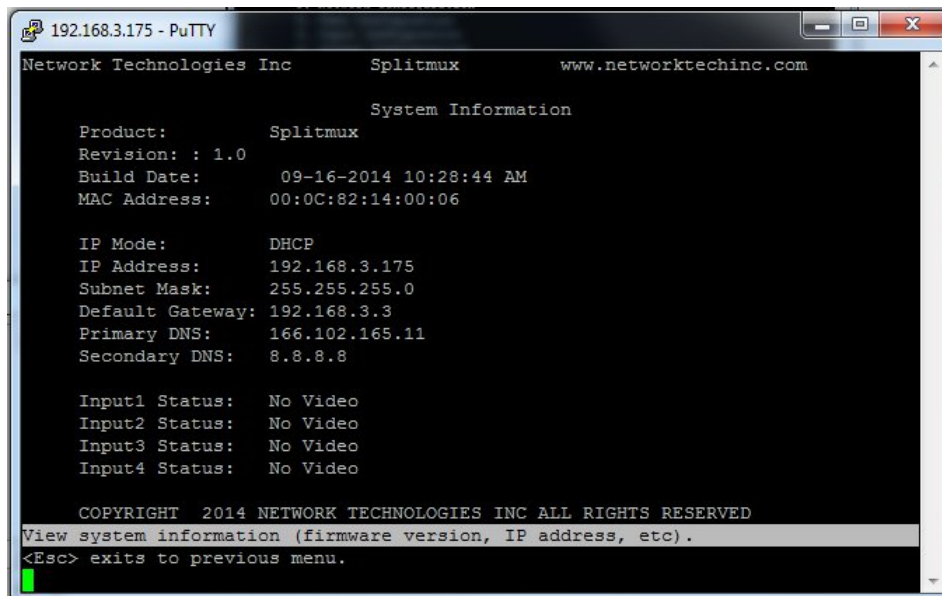

Figure 54- Text Menu- System Information

USING OSD

In OSD Mode, the front panel buttons are used to navigate and control the SPLITMUX using an on screen display (OSD) menu. To bring up the OSD menu, press the FULL and QUAD buttons at the same time. To exit the OSD menu, press them again. The OSD Mode can also be controlled using the attached keyboard (if connected) from Command Mode.

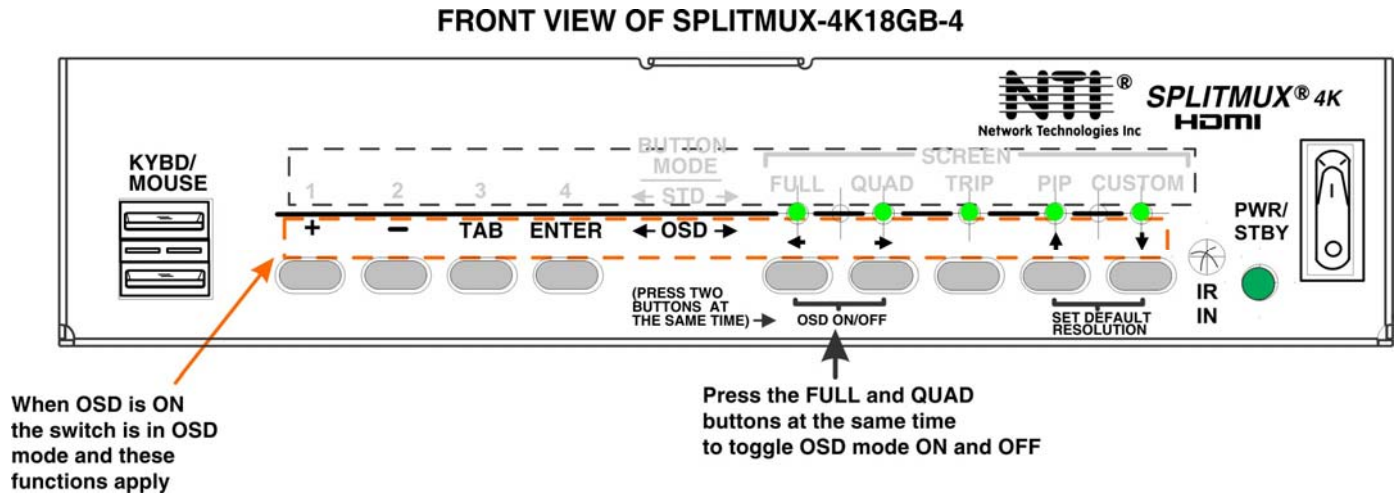

Figure 55- Front Panel Button OSD Functions

Navigating the OSD menus

While the OSD menu is on the display, the front panel buttons have the following functions:

- The “ENTER” button is used to execute a choice, like pressing the <Enter> key on the keyboard.
- The “TAB” button is used to move from one field to another in the menus.
- The “+” button is used to advance the field to another option, or increase a numeric value by one.
- The “-” button is used to decrement the field to another option, or decrease a numeric value by one.

The left, right, up and down arrows are only used in the OSD position screen to move the OSD screen to a different location on the display. As an arrow is pressed, the value of the horizontal or vertical position will increase or decrease as the OSD menu also moves in response to the button press.

TAB to “Save” and press ENTER to record your changes in the SPLITMUX.

TAB to “Cancel” and press ENTER to ignore and cancel any changes that were made

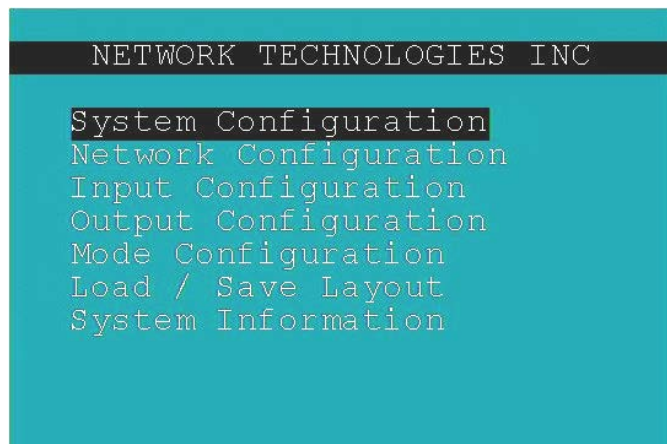

Figure 56- The OSD Menu

Most of the settings that can be changed using the web interface and text menus can also be changed using the OSD menus.

Function	Description
System Configuration	Configure system settings
Network Configuration	Configure network settings
Input Configuration	Configure which inputs will be viewed
Output Configuration	Configure how the images will appear on the display
Mode Configuration	Configure how each mode will behave
Load/Save Layout	Load or Save Custom Layout configurations
System Information	Display firmware version, MAC address, network settings and port status

Navigating OSD menus via Keyboard

To enter Command Mode and control the SPLITMUX OSD menu using the keyboard, press **<Ctrl> + <`>** (accent/tilde key) on the keyboard (press at the same time). Press **<Esc>** to exit Command Mode.

Keypress	Function
O (Letter "O")	Toggle OSD Menu (Open/ Close)
Down Arrow or Tab	Move down thru OSD menu selections
Enter	Select the Menu item
Left/Right Arrow	Change values of menu item
L / R / U / D	Move the OSD screen on the display

System Configuration

In the System Configuration screen provides 3 categories of settings to configure. Access to the OSD menu is controlled under Unit Settings, serial communication baud rate and address under Serial Settings, and the position of the OSD menu on the display under OSD Settings.

Select "Back" and press ENTER to return to the main menu.

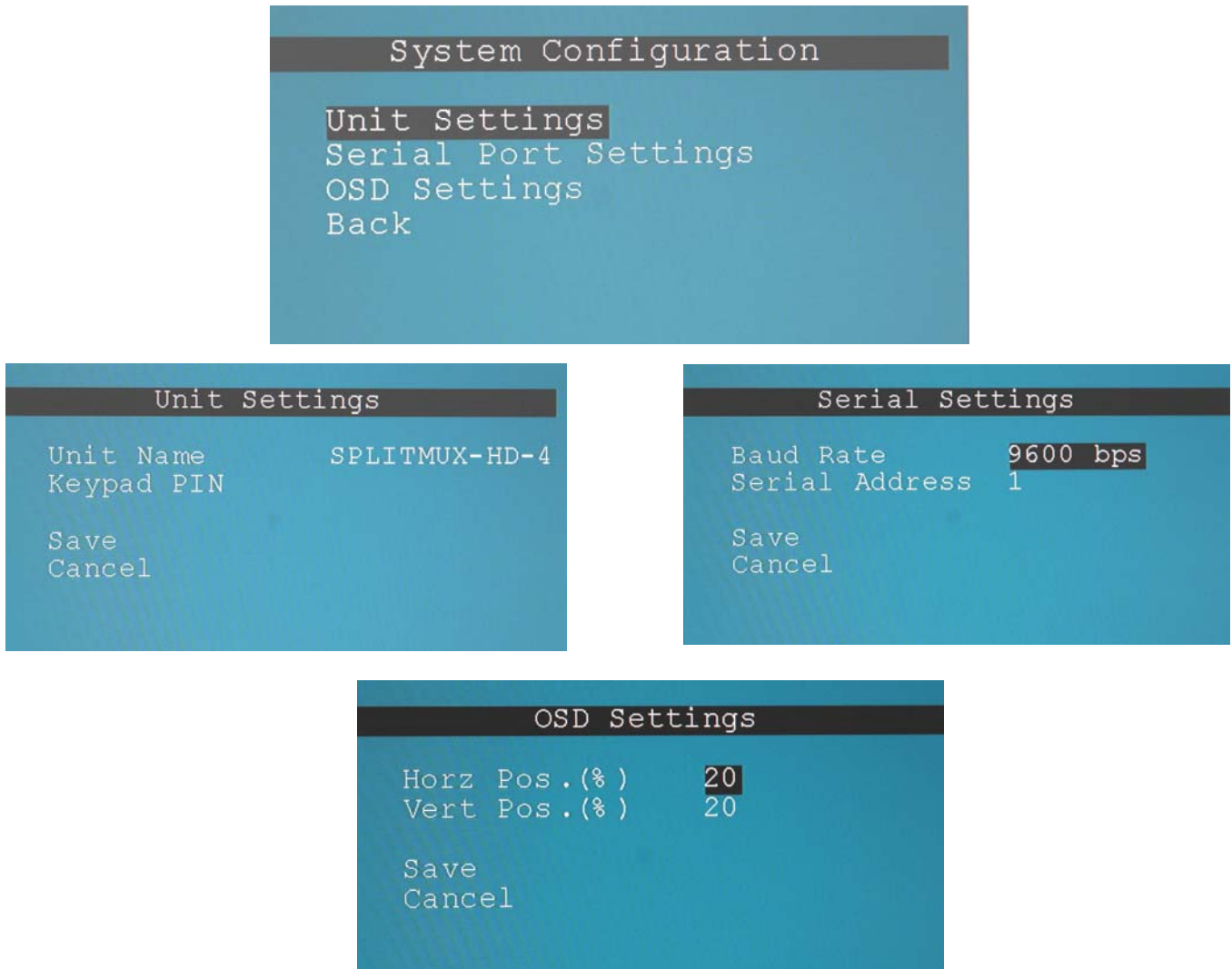

Figure 57- OSD System Configuration

System Settings	Description
Unit Settings	
Name	Unique name for this SPLITMUX to appear on the web interface login page and header of each web interface page
Keypad Pin	PIN number that must be entered before OSD mode can be accessed to change settings- 4 digits using buttons 1-4. 0000 (default) = No PIN required
Serial Port Settings	
Baud Rate	Baud rate for RS232 commands- select a value between 1200 and 115200 bps
Serial Address	Serial Address for RS232 commands and for the IR Remote- select value from 1-15
OSD Screen Settings	
Horiz Offset Position	OSD Horizontal Offset from left (0-70%) Use Arrow Buttons to move
Vert Offset Position	OSD Horizontal Offset from top (0-70%) Use Arrow Buttons to move

Network Configuration

The Network Configuration screen is where all network settings are entered. These settings determine how you will remotely access the SPLITMUX. Choose between your basic network (IPv4) settings and several miscellaneous server settings.



Figure 58- OSD Network Configuration

The IP address shown here is only used when the IPv4 Mode is set to “STATIC”.

To quickly view the IP address when the mode is set to “DHCP”, go to the “System Information” page (page 70).

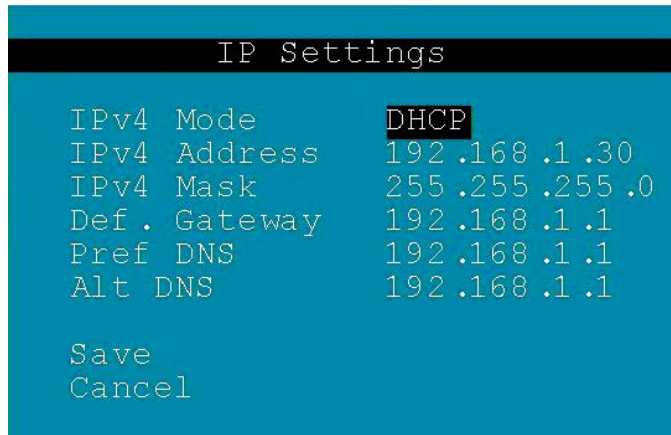

Figure 59- OSD IP Settings

IP Settings	
Mode	Select the method for acquiring IP Settings- Static (manual), DHCP (automatic) or Disable
IP Address	Enter valid IPv4 address (for Static Mode) (default is 192.168.1.30)
Subnet Mask	Enter valid subnet mask (for Static Mode)
Default Gateway	Enter valid default gateway (for Static Mode)
Primary DNS Address	Enter preferred name server (for Static Mode)
Alternate DNS Address	Enter alternate name server (for Static Mode)

Note: If you select “DHCP” for the mode, make sure a DHCP server is running on the network the SPLITMUX is connected to.

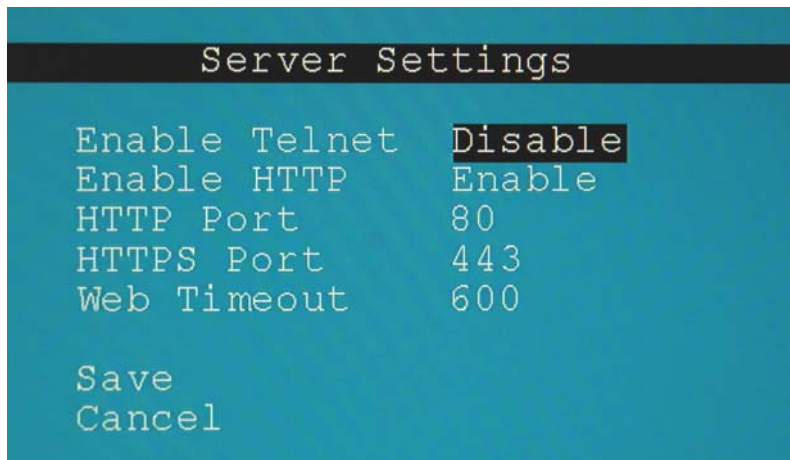

Figure 60- OSD Server Settings

Server Settings	
Enable Telnet	Change to “Enable” to permit access to the SPLITMUX via Telnet The default is disabled.
Enable HTTP	Change to “Enable” to allow access to the SPLITMUX via standard (non-secure) HTTP requests The default is disabled.
HTTP Port	Port to be used for standard HTTP (non-secure) requests (default is 80)
HTTPS Port	Port to be used for HTTPS (secure) requests (default is 443)
Web Timeout	Number of minutes after which idle web users will be logged-out (maximum is 32000, enter 0 to disable this feature)

Input Configuration

Configure what inputs will be viewed and heard on the display and what EDID mode they should be in from the Input Configuration screen. Select which input to configure and choose the settings to be applied.

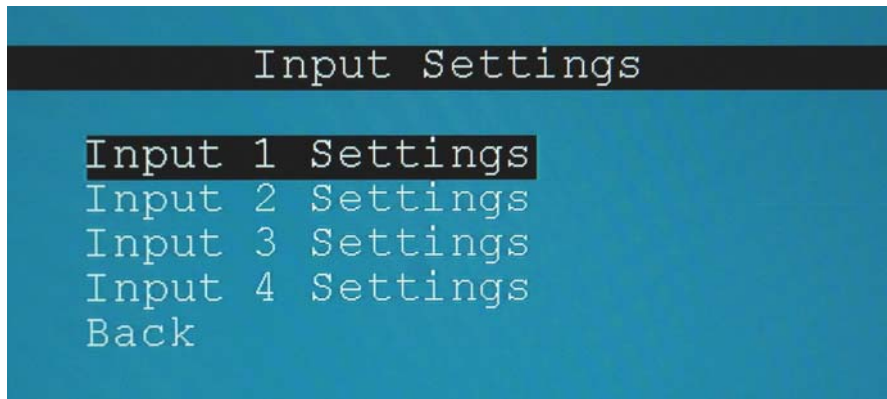

Figure 61- OSD Input Configuration

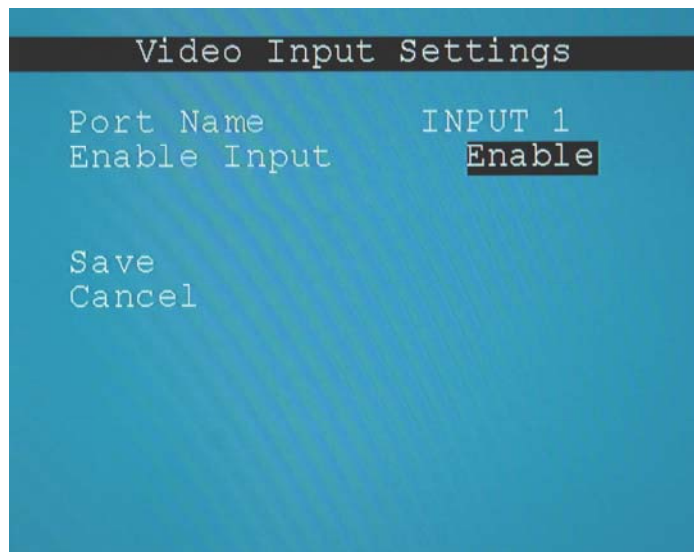

Figure 62- OSD Input Settings

Input Settings	
Input Channel x Port Name	Enter a port name to associate with the video source on Input 1
Enable	Choose to Enable or Disable the video input for this channel

Each Input channel can be configured with these settings.

Output Configuration

The Output Configuration determines how the inputs will be viewed on the display. From this menu you can also select the Audio Output Configuration which will provide settings for how the audio from the inputs is managed.

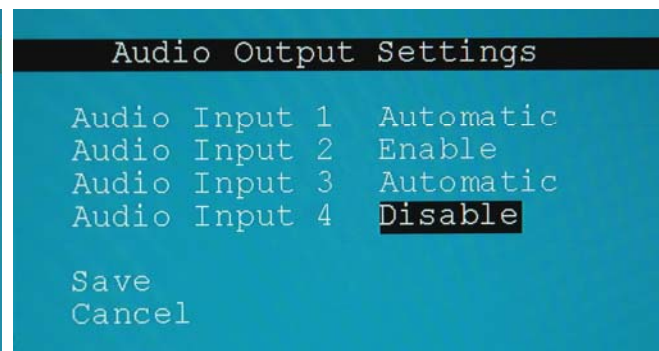
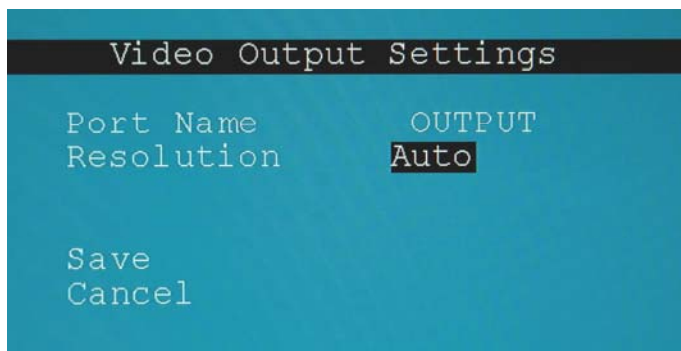

Figure 63- OSD Output Settings

Video Output Settings	
Output Port Name	Enter a port name to associate with the display (optional)
Output resolution	Select the output resolution to send to the display (options shown below) or select Auto to have it choose from the EDID table.

Note: When the Output resolution is set to “Auto”, your SPLITMUX will automatically sense the native resolution of your monitor and set the output resolution to that when powering ON the SPLITMUX.

Audio Output Settings	
Input 1 Audio Mode	Select the audio mode for the Input- between enabled/disabled/automatic
Input 2 Audio Mode	Select the audio mode for the Input- between enabled/disabled/automatic
Input 3 Audio Mode	Select the audio mode for the Input- between enabled/disabled/automatic
Input 4 Audio Mode	Select the audio mode for the Input- between enabled/disabled/automatic

When Audio Mode is enabled, the audio will come through any time the input signal is present (whether the video is enabled or not)

When Audio Mode is disabled, no audio will be heard from that input.

When Audio Mode is automatic, the audio will only be heard from that input if that input is the currently selected input. To avoid confusion from multiple audio inputs when using Quad,TRIP or PIP modes, set each audio input to automatic.

Video Output Resolutions to choose from (progressive scan):

1280x720@60Hz	2048x1080@60Hz	3840x2160@60Hz	4096x2160@30Hz
1920x1080@60Hz	3840x2160@30Hz	4096x2160@60Hz	

Mode Configuration

Mode Configuration will determine how each display mode provided by the SPLITMUX will be presented. Mode characteristics will determine how the images will look on the display.

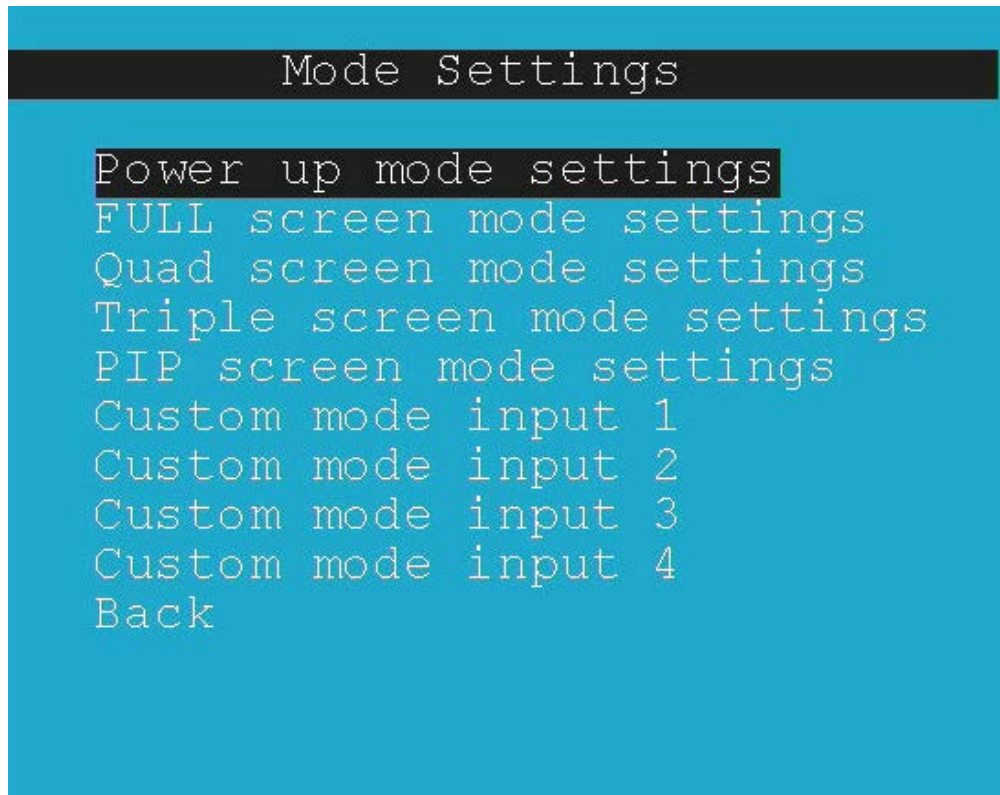

Figure 64- OSD Mode Settings

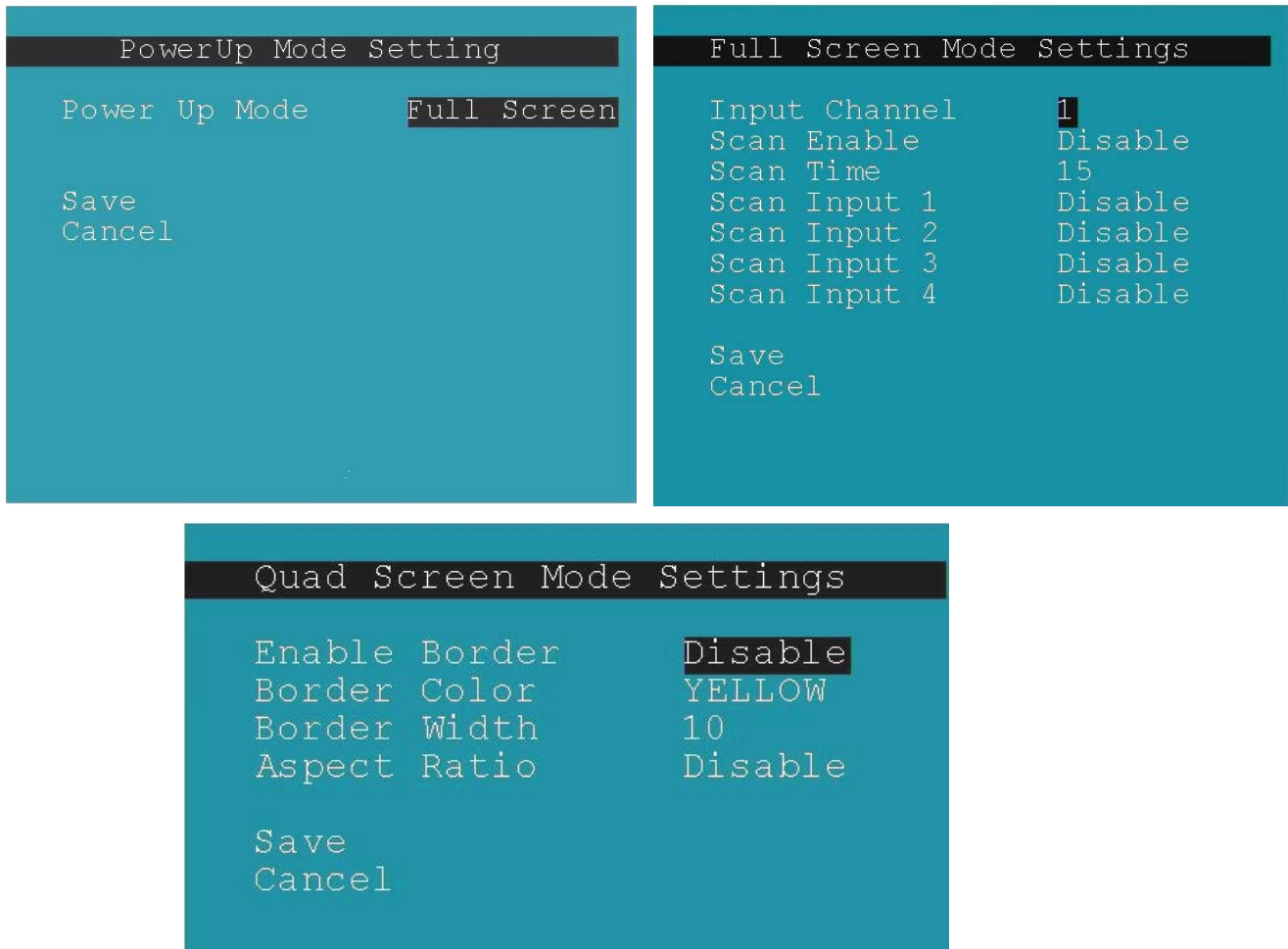

Figure 65- Default, Full Screen and Quad Screen Settings

Power Up Mode Setting	
Power Up Mode	Choose the default mode the SPLITMUX will be in when powered ON. Choose from Full screen , PIP screen, Quad screen or Custom screen

Full Screen Mode Settings	
Input Channel	Select the input channel assigned to Full Screen
Enable Scan	Enable scanning for the full screen input channel- to automatically switch from one channel to another
Scan time	Set the dwell time while scanning- the amount of time (in seconds) each channel will appear at full screen- range is 0-999
Scan input 1-4	Select Enable or Disable to include input 1, 2, 3 or 4 in the scanning sequence

Quad Screen Mode Settings	
Enable Border	Choose whether or not to place a border around each input displayed
Border Color	Choose the color of the border around each input
Border Width	Choose the width of the border around each input (0-50 pixels)
Aspect Ratio	Choose whether or not to maintain the aspect ratio for each displayed image

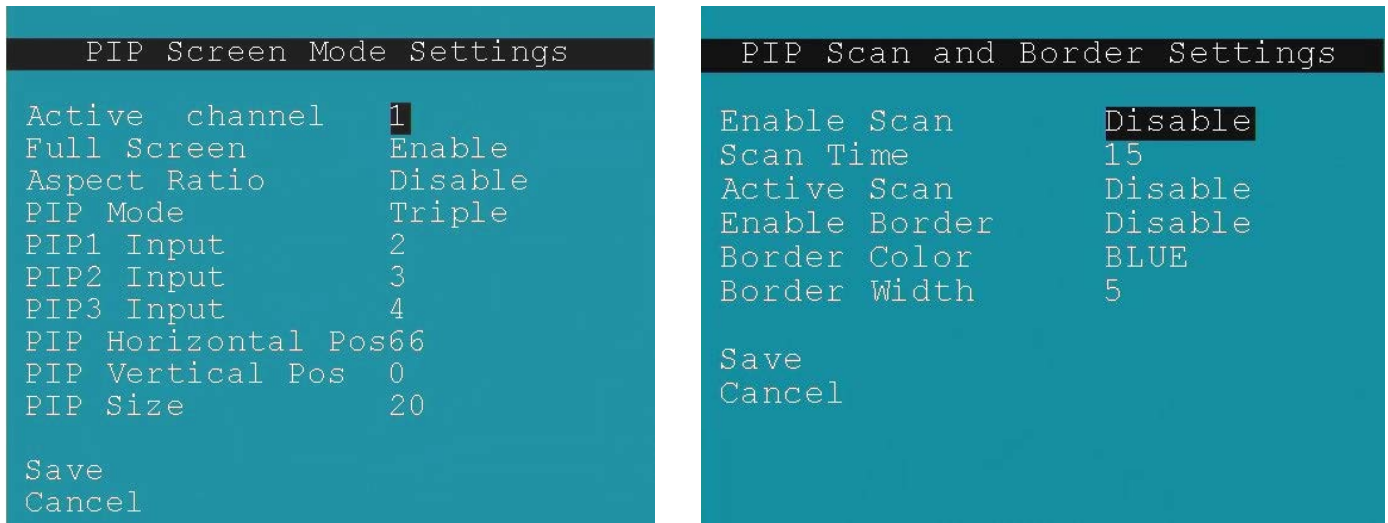

Figure 66- PIP Screen Mode settings

Pip Screen Mode Settings	
Active Channel	Select which active channel is in full screen mode
Enable full screen	Enable/disable active input in full screen mode with overlay
Enable aspect ratio	Enable/disable the aspect ratio to be maintained for all displayed images
PIP Mode	Select how many PIP images will be displayed, 2, 3 or 4 (one will be at full screen)
PIP 1 Input	Select which input channel will be in PIP upper right position
PIP 2 Input	Select which input channel will be in PIP center position
PIP 3 Input	Select which input channel will be in PIP lower right position
PIP Horizontal Position	Position of PIP images from the right side of the screen- range is 0-90% of screen width
PIP Vertical Position	Position of uppermost PIP from the top of the screen- range is 0-60% of screen height
PIP Size	Size of the PIP image- range is 10-50%
Enable Scan	Enable input channel scanning when PIP Mode is set to "Single"
Scan Time	Set the dwell time while scanning- the amount of time (in seconds) each channel will appear in the single PIP position- range is 0-999
Active Scan	Enable/disable full screen scanning between the inputs while in PIP mode
Enable Border	Place a border around each input displayed
Border Color	Choose the color of the border around each input
Border Width	Choose the width of the border around each input- from 0-50 pixels

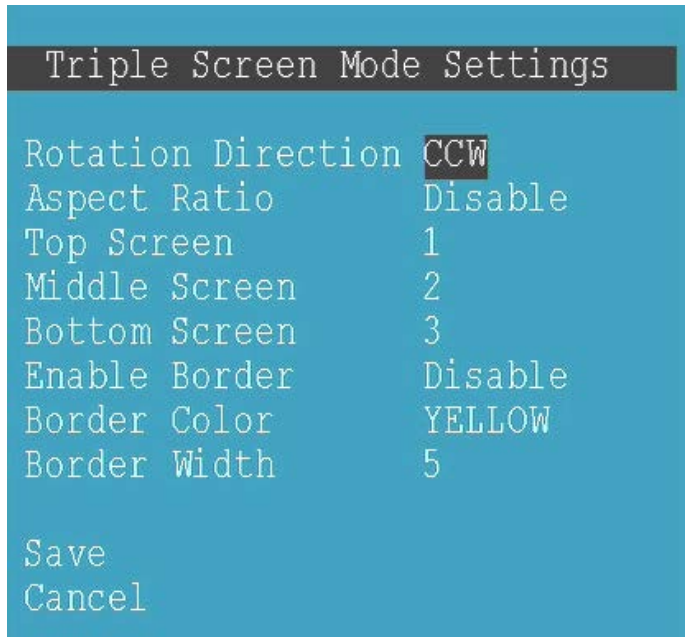

Figure 67-Triple Mode Settings

Triple Screen Mode Settings	
Rotation Direction	CW (clockwise) or CCW (counter-clockwise)
Aspect Ratio	Enable or Disable keeping the input aspect ratio
Top Screen	Select which input should be displayed on top
Middle Screen	Select which input should be displayed in the middle
Bottom Screen	Select which input should be displayed on the bottom
Enable Border	Disable or Enable a border for each input
Border color	Choose the color of the border around each input
Border width	Choose the width of the border around each input (0-50 pixels) (0 = no border)

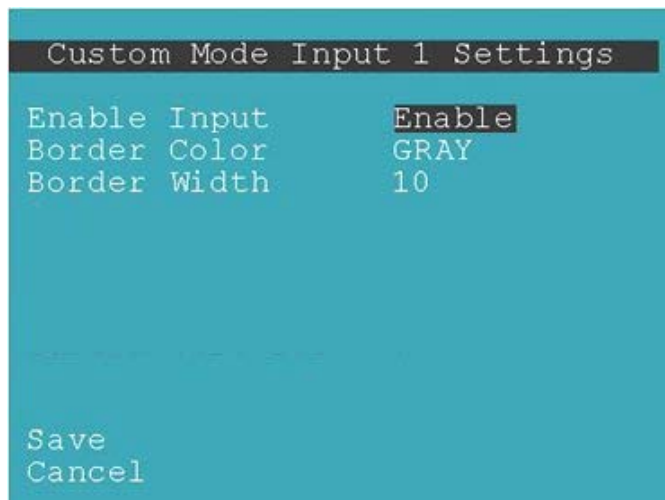

Figure 68- OSD- Custom Screen Mode Settings

Custom Screen Mode Settings Input x (1-4)	
Enable Input	Enable/disable displaying the content of the input
Border color for Input	Choose the color of the border around the input
Border width for Input	Choose the width of the border around the input (0-50 pixels) (0 = no border)

Load / Save Layout

When you have a screen layout configured in such a way that you want to save that layout for future viewing, select Load / Save Layout to open the Save Layout menu.

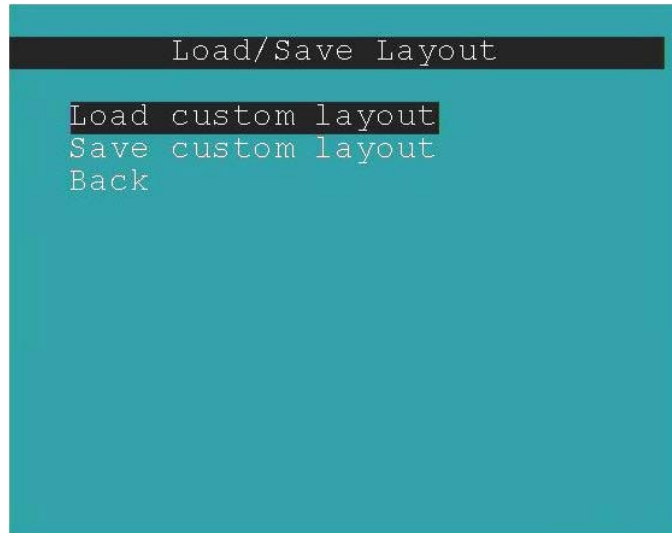

Figure 69- OSD- Load/Save Layout functions

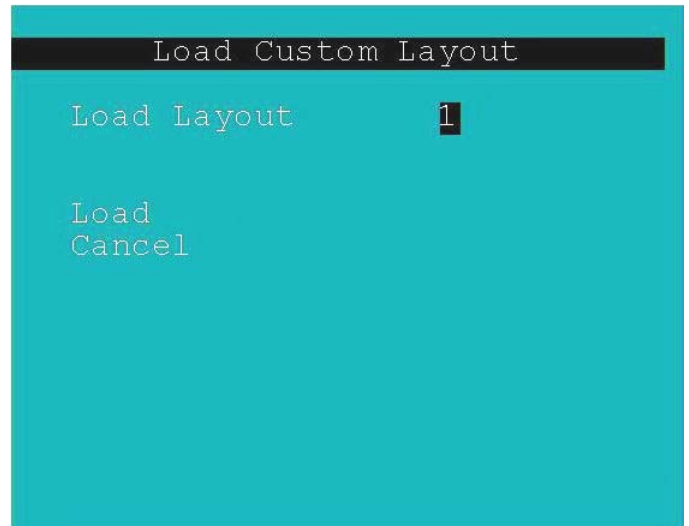
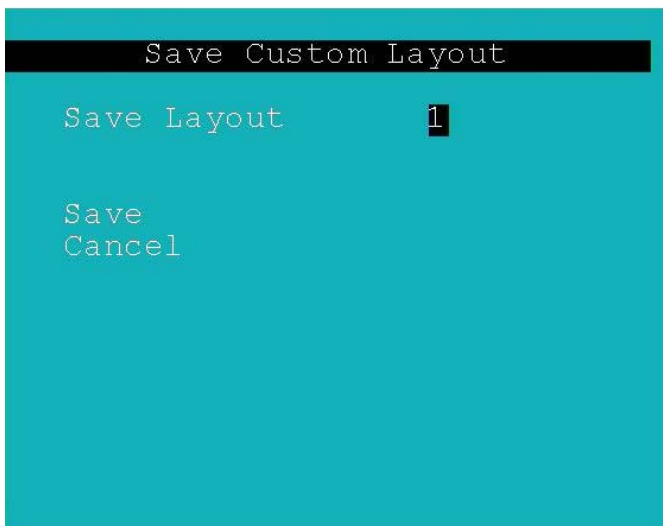

Figure 70- Save or Load a Custom Layout

Up to 10 custom layouts can be saved and re-loaded as needed.

System Information

Select System Information from the main menu to view the current network settings, MAC address, and port status. This is particularly helpful when the SPLITMUX is in DHCP mode with a server-assigned IP address.

The IP address shown below is used when the SPLITMUX is set to IP Mode: Static .

```
System Information
Revision:      1.0 :09-16-2014 10
MAC Address :  00 :0C :82 :14 :00 :06
IP Mode       :  DHCP
IP Address    :  192 .168 .1 .30
Subnet Mask   :  255 .255 .255 .0
Gateway       :  192 .168 .1 .1
Primary DNS   :
Sec . DNS    :
Input1Status :  No Video
Input2Status :  No Video
Input3Status :  No Video
Input4Status :  No Video
Back
```

Figure 71- OSD- System Information Page

INFRARED REMOTE CONTROL

The IRT-UNV Infrared Remote Control (optional-sold separately) provides the user with limited remote control of up to 15 NTI SPLITMUX-4K18GB-4 multiviewers. The IRT-UNV can control connections and change the operating modes without having to press buttons on the SPLITMUX case.

Note: The IRT-UNV will have no control over OSD menus.



Materials

Materials supplied with the IRT-UNV:

- NTI IRT-UNV Infrared Remote Control
- 2- AAA Batteries (installed)

Buttons

The IRT-UNV Infrared Remote Control user interface consists of a keypad with 29 buttons. Fourteen of those buttons are used for the SPLITMUX and have the following functions:

- **Numerical Values (1-4)**
 - Selects port numbers (for IN)
 - Select mode to switch to
- **IN**
 - Pressed to indicate an input port selection
- **OUT**
 - Pressed to initiate change of mode
- **SYS**
 - Pressed to select the desired SPLITMUX to be controlled
 - Only used when controlling multiple systems
 - Must be followed by a system number: 1-15
- **ENTER**
 - Press to have command take immediate effect
 - Press to complete command when SYS is used
- **SAVE**
 - Pressed to save a configuration of channels as viewed on the display
- **RECALL**
 - Pressed to recall and restore a configuration of channels previously viewed on the display
- **AUDIO** 
 - Press to select which input the audio controls will effect
- **VOL + / -**
 - Press to increase/decrease audio levels from selected input
- **MUTE Audio** 
 - Press to toggle audio on/off from selected input



Operation

Operation of the IRT-UNV is intuitive. The number of button presses required to complete any operation is kept to a minimum. This is accomplished using intelligent software within the NTI SPLITMUX. As a button is pressed, the PWR/STANDY green LED on the SPLITMUX will flash red to indicate it has received the signal (whether that signal is valid to cause a change or not).

Changing Ports

To change the Active input port (FULL screen mode), press <IN>, then the port number (1-4).

To change modes,

- For Full Screen Mode press <OUT>, then <1>
- For Quad Screen Mode press <OUT>, then <2>
- For Triple Screen Mode press <OUT>, then <3>
- For PIP Screen Mode press <OUT>, then <4>
- For Custom Screen Mode press <OUT>, then <5>

When changing the Active input port, the audio from that input port will also be heard provided the audio mode for the input is set to "Automatic" and no other audio mode for an input port is set to "Enable". See pages 23 or 64 for more.

To have any command take immediate effect, end it by pressing <ENTER>. (Example- press <IN> then <1> then <ENTER> to change to Active input port 1) Otherwise, there will be a 2 second delay for it to take effect.

Audio Control

Toggling Mute On/Off: Press <Audio>, then the port number (1-4), then <Mute>

Changing Audio Gain (Volume): Press <Audio>, then the port number (1-4), then Vol+ / Vol- (can be pressed once or many times)

Save and Recall

To save a configuration of channels on the display using the IR Remote control, the <Save> and <Recall> buttons are provided. Up to 10 configurations can be saved and recalled. Once the display has the configuration you want to be able to quickly return to, press the <Save> button followed by two digits (01-10). To recall a configuration at any time, press the <Recall> button followed by the associated two digit number.

Multiple Multiviewer Control

All NTI SPLITMUX-4K18GB-4 will work with the same IRT-UNV IR Remote control. As a result, a user with multiple NTI SPLITMUXs may find that, if the units are installed too close together, both units may respond to an IR command intended only for one unit. Also, the user may want to control multiple units with a single remote, instead of having one remote per unit. To control more than one SPLITMUX from one Remote, the IRT-UNV IR Remote provides the "SYS" button, which can be used to select the specific NTI unit to be controlled.

All units will have the capability to allow the user to set the unit address (1-15) (see page 18, 44 or 60). The default unit address is 1. Each switch to be separately controlled must be set to a different address prior to using the Remote Control.

With the addresses set;

1. press the <SYS> button on the IRT-UNV,
2. followed by a single (i.e. <1>) or two digit number (i.e. <0> then <1>) corresponding to the address of the unit to be controlled,
3. followed by <ENTER>.

Upon accepting the SYS command, the unit with the corresponding address will illuminate the "IR" LED in green for visual indication and respond to all IR Remote commands. All other units will illuminate in red and ignore any further commands.

Note: To prepare to send a command to all SPLITMUXs at the same time (all SPLITMUXs would have to be within line-of-sight of the IRT-UNV), press <SYS> then <0> then <ENTER>. Pressing <0> tells the Remote to send the command to all addresses. The PWR/STANDY LED on each SPLITMUX will illuminate and remain green to indicate readiness to receive commands.

Technical Specifications For IRT-UNV

Number of Controllable Systems	Max: 15
Pushbutton Control	29 keys
Power supply	2x AAA Battery
Chassis material	Plastic
Approvals	RoHS

Troubleshooting the IRT-UNV

PROBLEM	SOLUTION
IRT-UNV is not selecting inputs or changing modes	<ul style="list-style-type: none"> • Check battery • The IRT-UNV may be configured to control the wrong switch- see "Multiple Switch Control" above.

EXAMPLE OF CASCADED CONFIGURATION

In the example below, 4 SPLITMUXs are connected in a cascaded configuration.

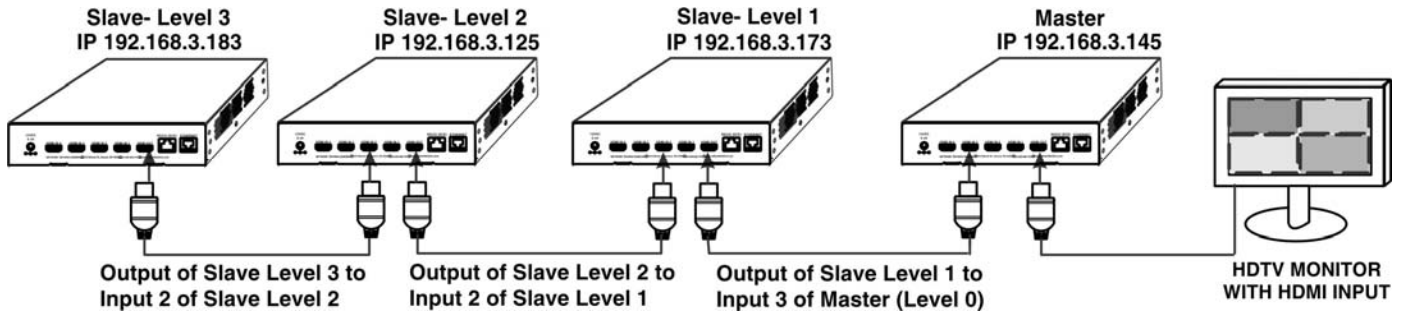

Custom Mode Settings

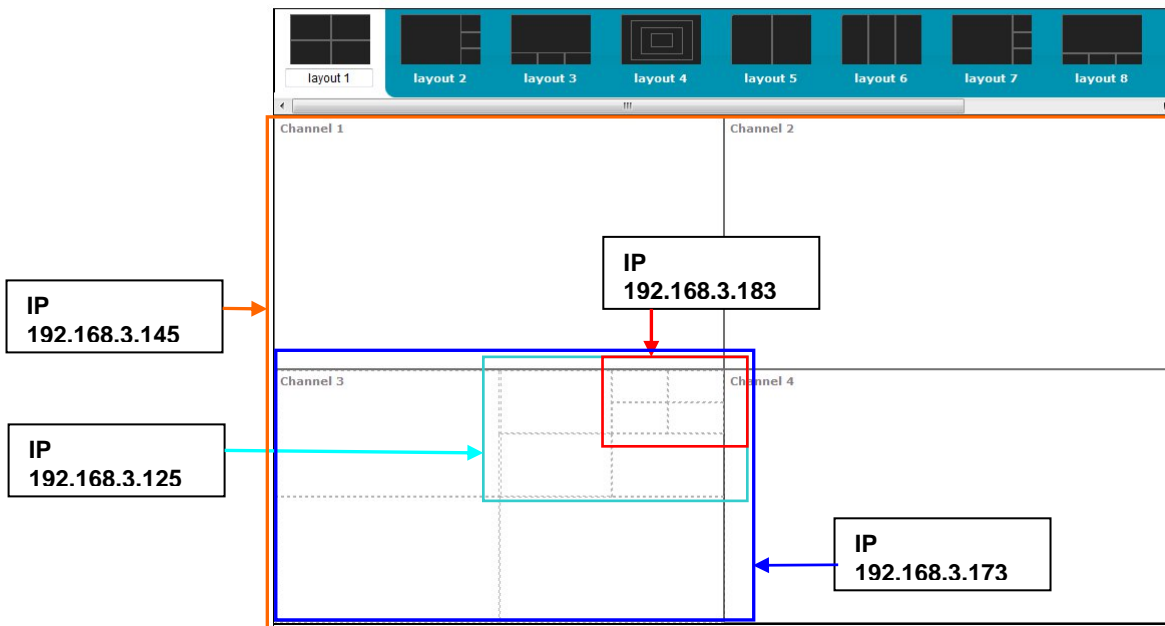

Figure 72- View of cascaded configuration from Master

The Custom Mode Settings page provides a view of the combined custom mode settings of the configuration. Dotted lines indicate input layouts of slave units connected. In order to make edits to the configuration of slave units, either change the IP address in the URL bar or double-click on the channel where slave units are indicated.

In Cascade Settings (image right), the slave connected to Input 3 is indicated. All other connections are direct, including the Output since on this SPLITMUX the output is connected to the display.

In this case, double-click on channel 3 to switch to the configuration of the SPLITMUX at IP 192.168.3.173.

Cascade Settings

Cascade Configuration	
Output type	Direct <small>Output connection type</small>
Output IP Address	<input type="text"/> <small>Output master IP address for cascade</small>
Input 1 type	Direct <small>Input 1 connection type</small>
Input 1 IP Address	<input type="text"/> <small>Input 1 IP address for cascade</small>
Input 2 type	Direct <small>Input 2 connection type</small>
Input 2 IP Address	<input type="text"/> <small>Input 2 IP address for cascade</small>
Input 3 type	Cascade Slave <small>Input 3 connection type</small>
Input 3 IP Address	192.168.3.173 <small>Input 3 IP address for cascade</small>
Input 4 type	Direct <small>Input 4 connection type</small>
Input 4 IP Address	<input type="text"/> <small>Input 4 IP address for cascade</small>
<input type="button" value="Save"/>	

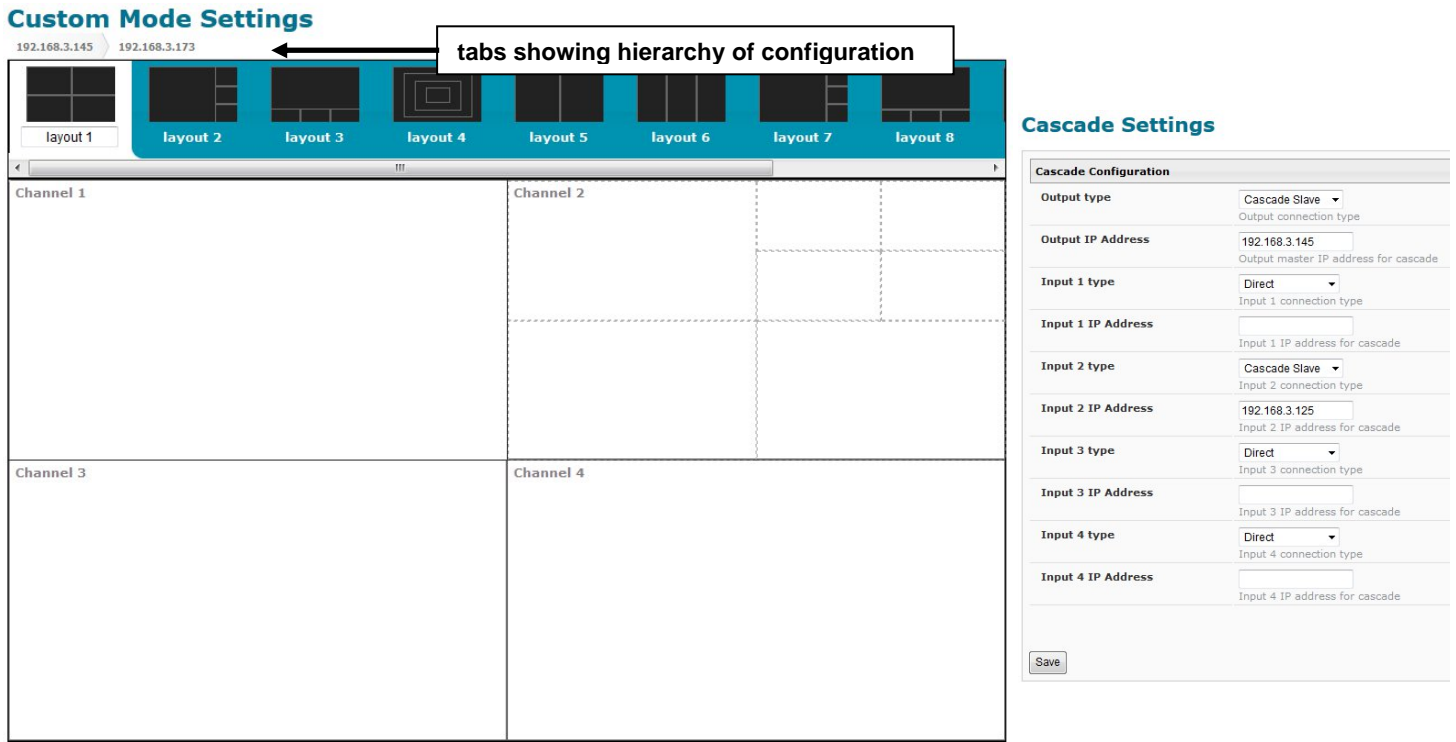

Figure 73- View of cascaded configuration from Slave at IP 192.168.3.173

When looking at a slave unit, the hierarchy will be indicated at the upper left of the layout choices. The leftmost tab is the master, followed by the nearest connected slave. In Figure 73, it is indicated that two levels of SPLITMUXs are connected through channel 2 (Input 2). These are, of course, IP 192.168.3.125 and IP 192.168.3. 183.

Any edits made using the web interface configuration menu at this level will directly and only impact the SPLITMUX at IP 192.168.3.173.

To switch back to the configuration of the master, click on the tab labeled “192.168.3.145”.

To switch to the next slave in the configuration (IP 192.168.3.125), double-click on channel 2.

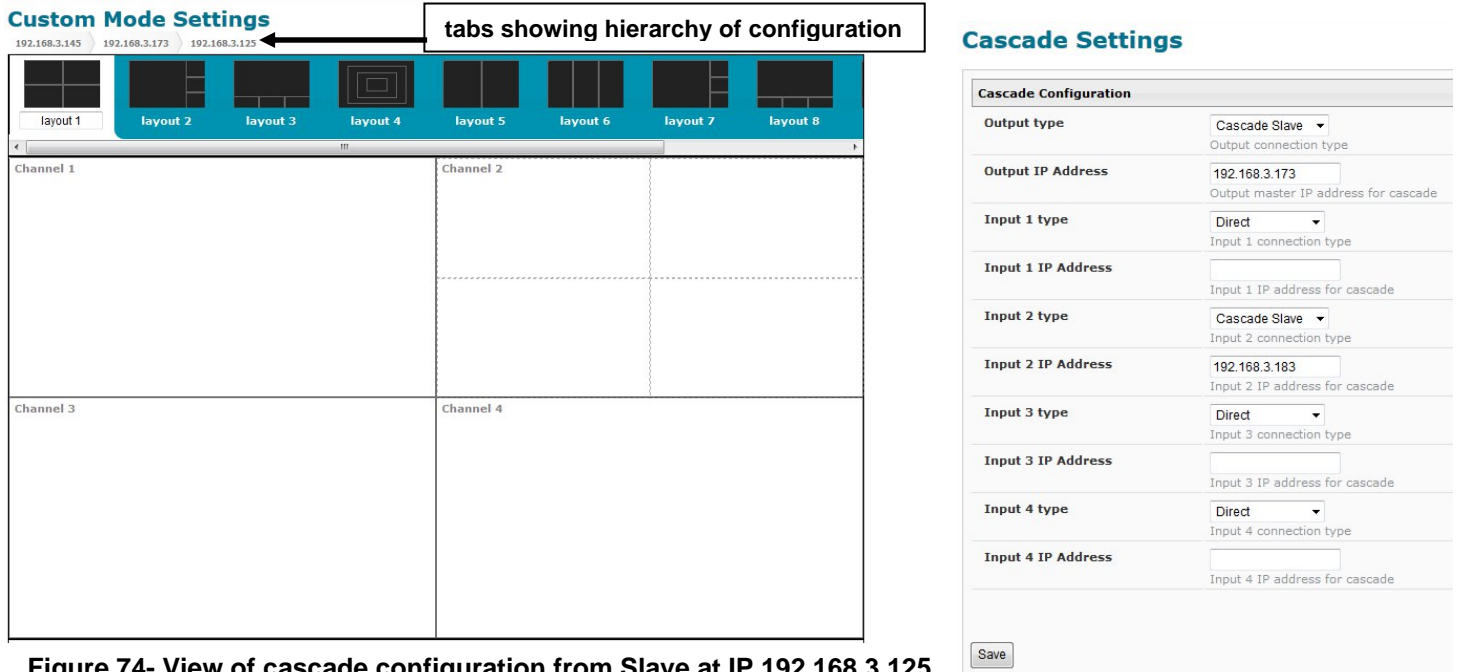

Figure 74- View of cascade configuration from Slave at IP 192.168.3.125

In Figure 74, it is indicated that one level of SPLITMUX is connected through channel 2 (Input 2). This is IP 192.168.3.183.

Notice that in Cascade Settings the slave (192.168.3.183) is configured for connection to Input 2, and the upstream slave (192.168.3.173) is connected to the output. Other input ports are configured for direct connection to input sources.

Any edits made using the web interface configuration menu at this level will directly and only impact the SPLITMUX at IP 192.168.3.125.

To switch to the last slave in that configuration (IP 192.168.3.183), double-click on channel 2.

To switch back to the configuration of the master or upper level slave, click on the appropriate tab.

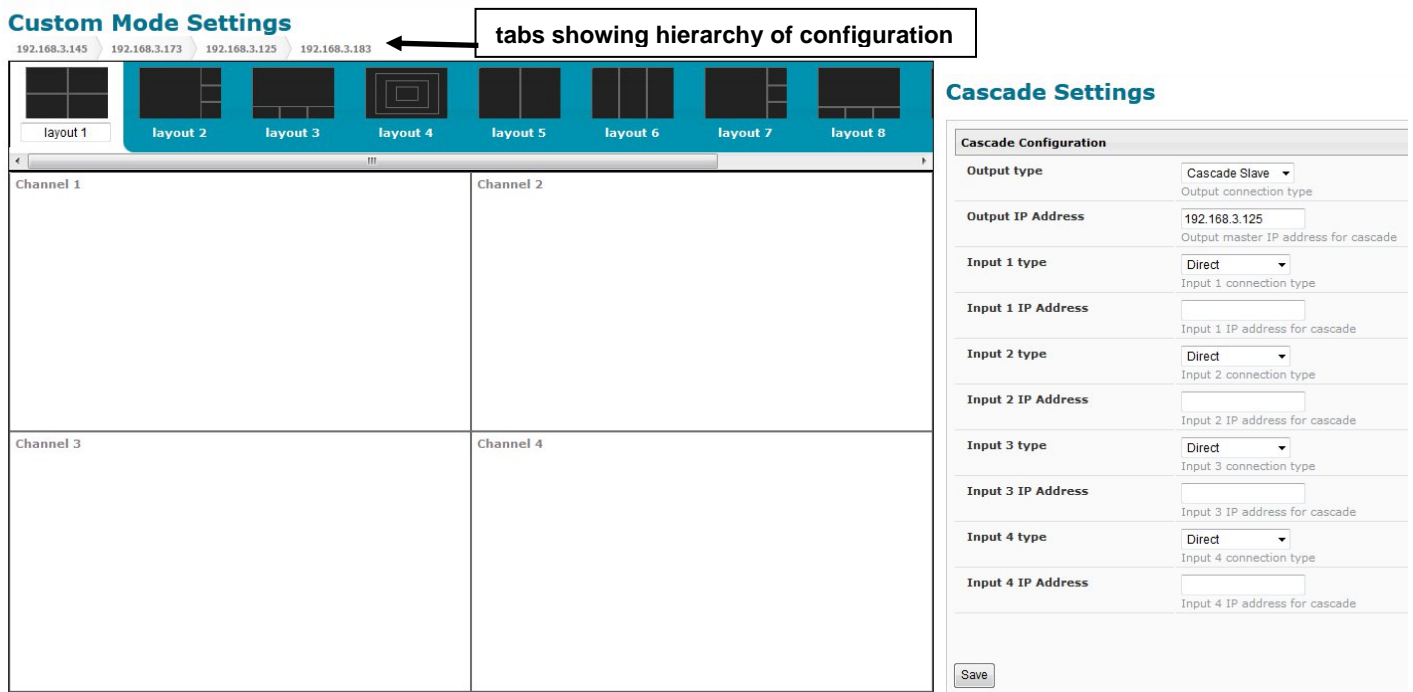

Figure 75- View of custom configuration of Slave at IP 192.168.3.183

In Figure 75, we see that there are no slaves connected to this SPLITMUX. In Cascade Settings, only the output master IP address is configured.

At each configuration level, the Current Mode setting will dictate what is viewed upstream at the output, regardless of how the custom layout is configured. The custom layout will only impact what is viewed if the Current Mode is set to “Custom” (page 17). The audio is impacted in the same fashion. If the audio from an input on the lowest-level slave is desired, the configured input channel for each higher level slave must be set to pass that audio signal, all the way through to the master.

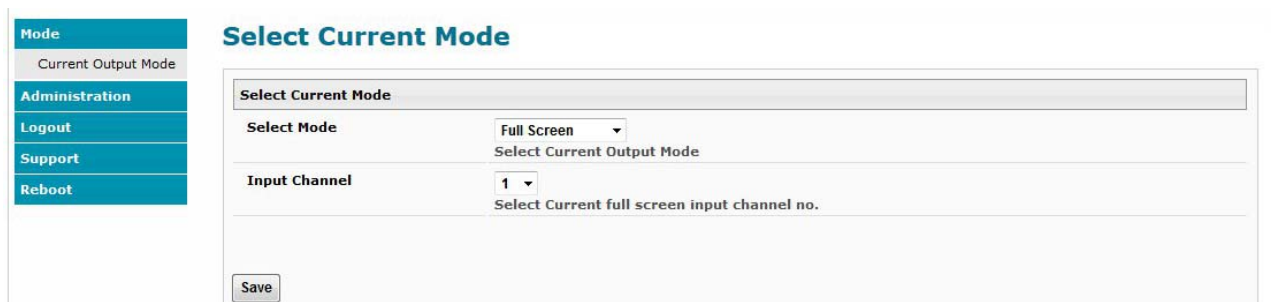

Figure 76- Current output mode selection

SPECIFICATIONS

Video Signal Supported	HDMI and DVI
Resolution supported	Up to UHD(2160p), 4096 x 2160 @ 60Hz
HDMI supported	Input: 24,30 and 36-bit RGB, YCbCr 4:4:4, YCbCr 4:2:2 Output: 24-bit, RGB
Audio supported	4-channel mixing stereo with 16,20 or 24 bit uncompressed PCM audio
Bandwidth	594 MHz (5.94 Gbps)
HDCP Compliant	V2.2
Ports (SPLITMUX-4K18GB-4)	1- HDMI output 4- HDMI inputs 1- RJ45 Ethernet 1- RJ45 RS232 1- 2.1mm x 5.5mm power jack 2- USB Keyboard/Mouse
Additional Ports (SPLITMUX-USB4K18GB-4 only)	2- USB 2.0 High Speed Transparent
Protocols supported	HTTP, HTTPS, TCP/IP, DHCP, UDP, ARP, IPV4
Operating temperature	32 to 122°F (0 to 50°C).
Storage temperature	-22 to 140°F (-30 to 60°C).
Operating and storage relative humidity	5 to 90% non-condensing RH.
Power	120VAC or 240VAC at 50 or 60Hz-12VDC/8.3A AC Adapter
Power consumption	35W
Dimensions WxDxH (in) SPLITMUX-(USB)4K18GB-4 w/o rackmount kit and cable tray	7.85 x 6.96 X 1.71 (199.4x176.8x43.4 mm)
SPLITMUX-(USB)4K18GB-4 w rackmount kit and cable tray	19 X 10 X 1.71 (483x254x43.4 mm)
Case material	powder coated steel
MTBF	70,102 Hours
Shelf life	Indefinite
Regulatory approvals	CE, RoHS

TROUBLESHOOTING

Each and every piece of every product produced by Network Technologies Inc is 100% tested to exacting specifications. We make every effort to insure trouble-free installation and operation of our products. If problems are experienced while installing this product, please look over the troubleshooting chart below to see if perhaps we can answer any questions that arise. If the answer is not found in the chart, a solution may be found in the knowledgebase on our website at <http://information.networktechinc.com/jive/kbindex.jspx> or contact us directly for help at 1-800-742-8324 (800-RGB-TECH) in US & Canada or 1-330-562-7070 worldwide. We will be happy to assist in any way we can.

Problem	Cause	Solution
Image on monitor is blurry, has wavy lines, colors are off, or just is not very good on all ports; all modes	<ul style="list-style-type: none"> Resolution of Output Setting is not supported by the monitor. Poor quality output cable Poor cable connection 	<ul style="list-style-type: none"> Check the Output Resolution setting (page 23) against the specifications for the connected display. Try a different output cable Try to hot plug cable at the SPLITMUX and at the display
Cannot log in to SPLITMUX via Ethernet	<ul style="list-style-type: none"> Incorrect IP address has been entered in the browser User is on a different subnet 	<ul style="list-style-type: none"> Check the System Information page from the front panel LCD display for the assigned IP Address Make sure user is on same subnet as the SPLITMUX
Cannot connect to SPLITMUX via Telnet	<ul style="list-style-type: none"> Settings are not correct User is on different subnet 	<ul style="list-style-type: none"> Enable Telnet using the Web Interface (Network Settings page) Make sure you are entering the correct IP Address (check System Information page) Make sure you connect via port 2000 (the default port for Telnet is 23 but this will not work) Make sure you are trying to connect from the same subnet the SPLITMUX is on
No Audio	The audio may be disabled or the channel with the audio has not been selected	Make sure audio has been enabled and the channel from which audio is desired has been selected
Cannot get an image on the display	<ul style="list-style-type: none"> The display does not support the selected output resolution There may be a sync issue 	<ul style="list-style-type: none"> Check the Output Resolution setting (page 23) against the specifications for the connected display. Hot plug the output cable to the display
Image poor coming from input port X (1-4)	Poor cable or poor connection	<ul style="list-style-type: none"> Try a different cable Hot plug the cable at the SPLITMUX and at the source as needed

Removing Lines

When using Quad mode to merge 4 video sources onto one large monitor, you will likely see lines between the channels.

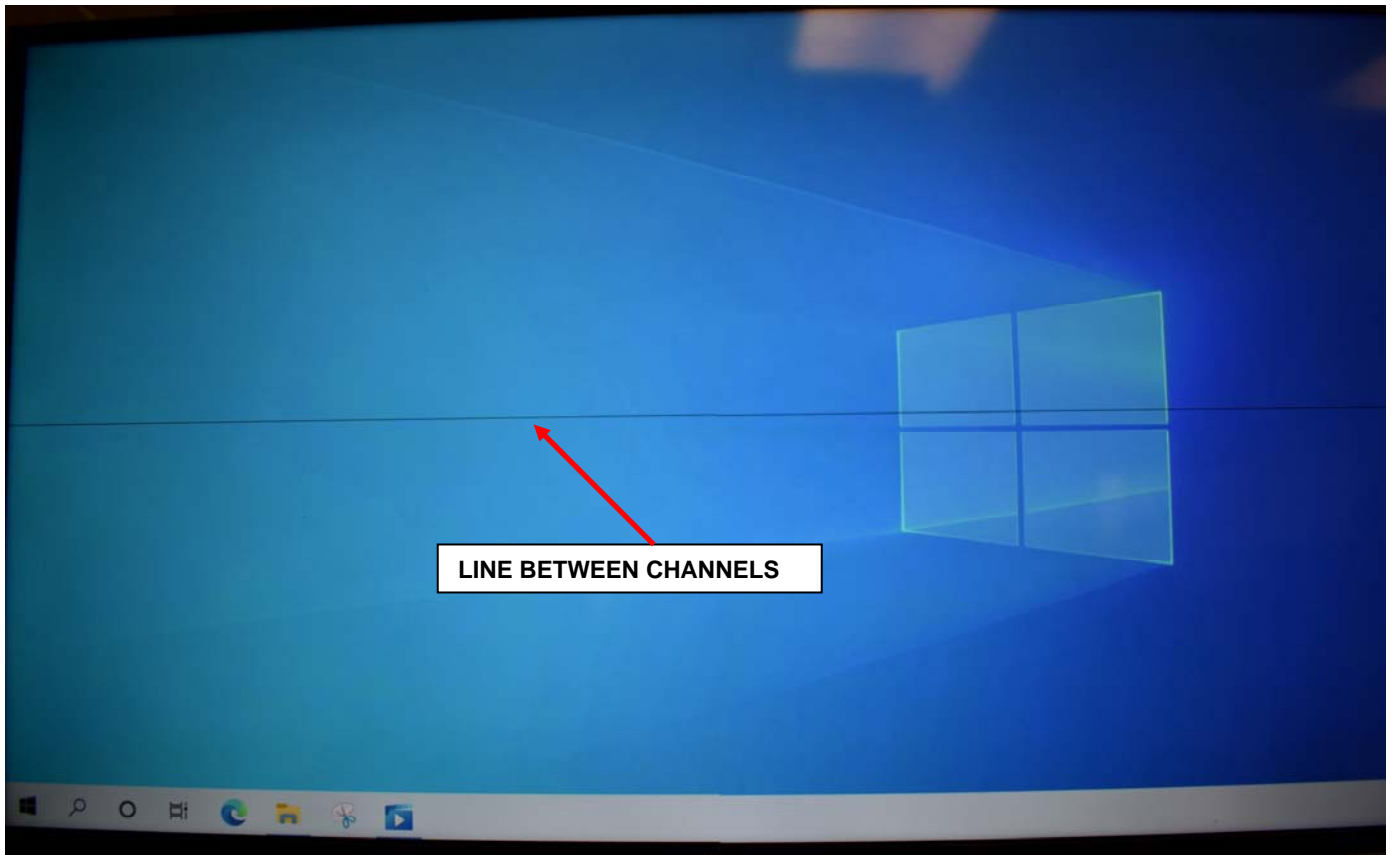

To remove the lines and perfect the images, using Custom Mode, increase the dimensions of the channels by a few pixels to make them overlap other channels. (Example of possible changes that can be made in image below-right.)

Channel 1		Channel 2	
Aspect Ratio:	Free Ratio	Aspect Ratio:	Free Ratio
Border Width:	0	Border Width:	0
Border Color:	BLACK	Border Color:	BLACK
Transparency:	0%	Transparency:	0%
Zoom:	100%	Zoom:	100%
Display VOL-L:	<input type="checkbox"/>	Display VOL-L:	<input type="checkbox"/>
Display VOL-R:	<input type="checkbox"/>	Display VOL-R:	<input type="checkbox"/>
Display UMD:	<input type="checkbox"/>	Display UMD:	<input type="checkbox"/>
Enable Audio:	<input type="checkbox"/>	Enable Audio:	<input type="checkbox"/>
Default Size/Pos		Default Size/Pos	
Width:	1920	Width:	1920
Height:	1080	Height:	1080

Channel 3		Channel 4	
Aspect Ratio:	Free Ratio	Aspect Ratio:	Free Ratio
Border Width:	0	Border Width:	0
Border Color:	BLACK	Border Color:	BLACK
Transparency:	0%	Transparency:	0%
Zoom:	100%	Zoom:	100%
Display VOL-L:	<input type="checkbox"/>	Display VOL-L:	<input type="checkbox"/>
Display VOL-R:	<input type="checkbox"/>	Display VOL-R:	<input type="checkbox"/>
Display UMD:	<input type="checkbox"/>	Display UMD:	<input type="checkbox"/>
Enable Audio:	<input type="checkbox"/>	Enable Audio:	<input type="checkbox"/>
Default Size/Pos		Default Size/Pos	
Width:	1920	Width:	1920
Height:	1080	Height:	1080

Default Dimensions

Channel 1		Channel 2	
Aspect Ratio:	Free Ratio	Aspect Ratio:	Free Ratio
Border Width:	0	Border Width:	0
Border Color:	BLACK	Border Color:	BLACK
Transparency:	0%	Transparency:	0%
Zoom:	100%	Zoom:	100%
Display VOL-L:	<input type="checkbox"/>	Display VOL-L:	<input type="checkbox"/>
Display VOL-R:	<input type="checkbox"/>	Display VOL-R:	<input type="checkbox"/>
Display UMD:	<input type="checkbox"/>	Display UMD:	<input type="checkbox"/>
Enable Audio:	<input type="checkbox"/>	Enable Audio:	<input type="checkbox"/>
Default Size/Pos		Default Size/Pos	
Width:	1920	Width:	1920
Height:	1082	Height:	1082

Channel 3		Channel 4	
Aspect Ratio:	Free Ratio	Aspect Ratio:	Free Ratio
Border Width:	0	Border Width:	0
Border Color:	BLACK	Border Color:	BLACK
Transparency:	0%	Transparency:	0%
Zoom:	100%	Zoom:	100%
Display VOL-L:	<input type="checkbox"/>	Display VOL-L:	<input type="checkbox"/>
Display VOL-R:	<input type="checkbox"/>	Display VOL-R:	<input type="checkbox"/>
Display UMD:	<input type="checkbox"/>	Display UMD:	<input type="checkbox"/>
Enable Audio:	<input type="checkbox"/>	Enable Audio:	<input type="checkbox"/>
Default Size/Pos		Default Size/Pos	
Width:	1920	Width:	1920
Height:	1082	Height:	1082

Adjusted Dimensions

With the dimensions adjusted, click on each channel in the viewer to bring that channel to the forefront (page 28). With the right adjustments and selection, the line(s) will disappear. Once the displayed channels look as intended, that configuration will remain in place until you change it.

If you decide you want to save it for re-use later, you can save the layout to one of the 10 preset layouts, and if you have more than 10, you can download the configuration for re-use at any time (see page 29).



Figure 77- Four channels, overlapping to remove lines

INDEX

- baud rate, 38
- cascade settings, 32
- Command Mode**, 14, 59
- connections, 7
- custom settings, 28
- default IP address, 16
- Device Discovery Tool, 15
- downloads, 37
- Ethernet**, 9
- firmware update-web, 35
- Hot Mouse mode**, 14
- IRT-UNV, 71
- Java Runtime Environment, 15
- load layout, 31, 56, 69
- log in, 16
- network settings, 20
- OSD menus, 58
- OSD via Keyboard, 59
- output settings, 22
- Password**, 16
- RS232 pinout, 38
- save layout, 31, 56, 69
- serial settings**, 18
- system information, 36
- Telnet, 40
- terminal, 9
- text menu, 41
- username and password, 16
- users, 34, 47
- web browsers supported, 2