

PureLink

BEYOND 4K

SX-8800 Seamless UHD Matrix

Version 1.0



Contents

1	Introduction.....	3
2	Front Panel Control	3
3	Rear Panel.....	4
4	RS232/LAN Control.....	6
4.1	RS232 connector.....	6
4.2	Ethernet control and connection	6
5	PC tool user guide	7
5.1	Account’s authentication.....	7
5.1.1	Password modification	7
5.2	Connect with PC tool.....	8
5.3	Matrix Switch page.....	9
5.4	Signal Setting page	10
5.5	FineTune	11
5.6	TV Wall.....	11
5.6.1	Build a wall	11
5.6.2	Bezel adjust	13
5.6.3	One more TV wall.....	14
5.6.4	Multi View with TV Wall.....	14
5.6.5	Save scene/ Load scene.....	15
5.7	Advanced route switch page	15
6	Control via Web.....	15
7	Electrical parameters.....	16
8	Appendix A: Query IP info via UART	17
9	Appendix B: Query IP address info via Network.....	18
10	Appendix C: Set IP info via UART	19
11	Appendix D: Set IP info via Network.....	20
12	Appendix E: Set IP address on Windows 7 or XP.....	21
13	Appendix F: Direct connect via Ethernet cable	23
14	Appendix G: Connect via network route /switch	24
15	Appendix H: Troubleshoot with Network control	25
16	Appendix I: Advanced routing switch.....	26

1 Introduction

SX-8800 provides seamless switching of up to (8) HDMI 2.0 inputs and outputs and incorporates the latest technologies available on the market including HDR and HDCP 2.2 compliance. The SX-8800 matrix switchers also feature a built-in web page interface/software allowing convenient set-up, user access, control, and operation. It also features audio extraction as well as audio insertion. Together with video wall function/advanced EDID management and added security features, the SX series delivers a true, first-in-class Ultra HD multi-zone signal distribution solution ideal for corporate conferencing, education, and hospitality environments, to name a few.

SX-8800 key features:

- HDMI 2.0/HDCP 2.2
- seamless switching
- video wall
- IR matrix
- HDMI audio extract
- external LR audio insert on HDMI stream
- EDID management
- HDMI video output resolution up to 3840x2160@60
- Front panel, RS232, TCP/IP (LAN 10M/100M) and Windows Matrix program control

2 Front Panel Control

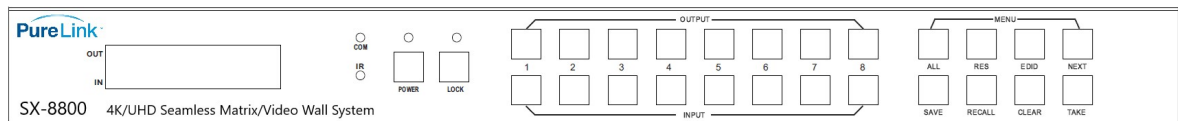

- **OUTPUT/INPUT buttons**
Press buttons OUTPUT n + INPUT m+ TAKE by sequence, switch matrix input n to output m.
- Press button POWER and hold for 5 seconds, to make the matrix enter standby state.
Press button POWER and hold for 1 seconds to power on the matrix.
- Press button LOCK more than 2 seconds and less than 6 seconds, to lock or un-lock front buttons.
When locked, the Lock LED will be solid on;
Press button LOCK more than 6 seconds, enter into the input output lock menu, then press IN n.
Or OUTPUT button to toggle the input or output lock status, then press TAKE to set,
Press CLEAR to exit.
- Press buttons ALL + INPUT m + TAKE by sequence, to switch input m to all outputs.
 - Press button SAVE + OUTPUT n to save current routing scene as scene n. There are eight scene memories available.
- Press button RECALL + OUTPUT n to recall routing scene n.
- Press button RES + OUTPUT n + NEXT + TAKE, to change output resolution of OUTPUT n
Resolution options:
 - 3840x2160@60
 - 3840x2160@50

- 3840x2160@30
 - 3840x2160@25
 - 1920x1200@60
 - 1920x1080@60
 - 1920x1080@50
 - 1600x1200@60,
 - 1400x1050@60
 - 1366x768@60
 - 1360x768@60
 - 1280x1024@60
 - 1280x768@60
 - 1280x720@60
 - 1280x720@50
 - 1024x768@60
- Press buttons EDID + INPUT m + NEXT + TAKE, change the EDID mode of port INPUT m
EDID option:
 - Manual
 - 3840x2160@60
 - 3840x2160@30
 - 1920x1200@60
 - 1920x1080@60
 - 1280x1024@60
 - 1280x720@60
 - 1024x768@60
 - Manual EDID is loaded by PC Tool

3 Rear Panel

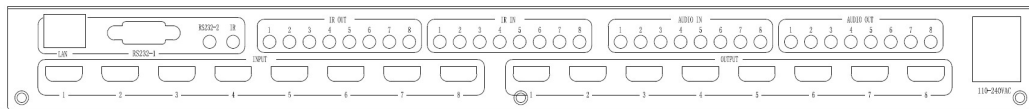

- LAN(10M/100M), RS232 for PC control
- Analog Audio IN/OUT ports bind to corresponding HDMI ports.

Example:

If HDMI 1 audio source is selected with External LR by PC Tool, then analog AUDIO IN LR1 (with $\phi 3.5\text{mm}$ jacket) will be selected to replace the embedded audio of the HDMI input 1 data stream. If HDMI 1 audio source is selected with AUTO by PC TOOL, then will use the original embedded audio of input HDMI 1 as its audio data stream.

If input is DVI signal, no matter how it is set up, system will get external analog audio input. Analog AUDIO OUT n will always output the same audio content with HDMI OUTPUT n Analog Audio IN/OUT connection

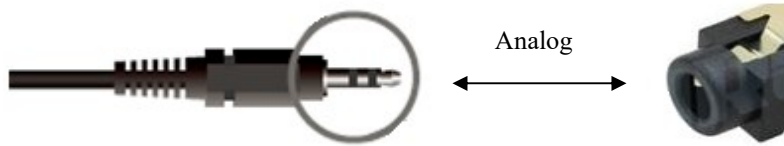

- IR IN and IR OUT

IR IN/OUT is for remote control routing, and follow the video routing.

For example, if input HDMI m is routed to output HDMI n1 and n2 ports, then IR IN n1 and n2 ports will be routed to IR OUT m port. Please refer bellow illustration.

Relationship between video and IR routing

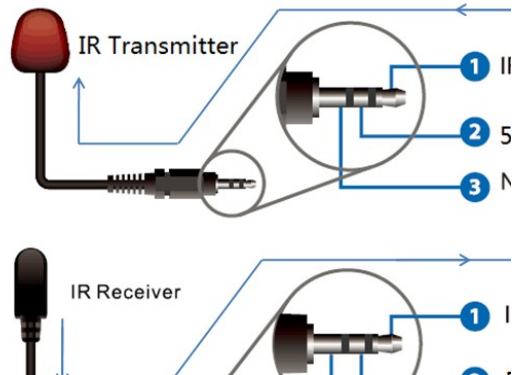
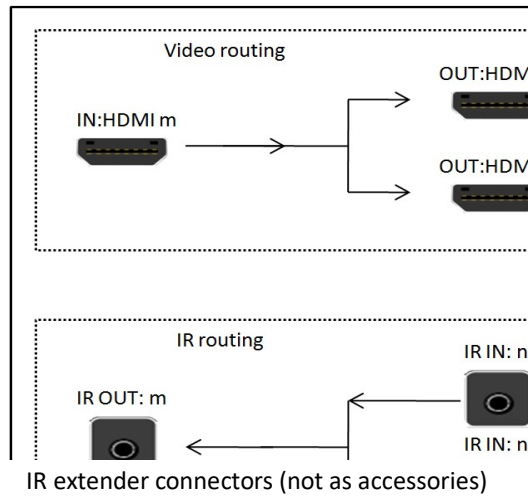

4 RS232/LAN Control

4.1 RS232 connector

- RS-232 control, baud rate 9600, DB9 connector
- Port RS232-1 is DB9 female connector, Pins layout as bellow. User need use the corresponding cable, directly/straight RS232 cable

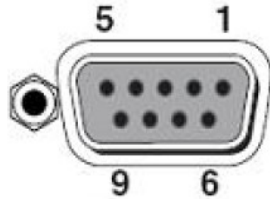

I	Pin
1	N/u
2	Tx(Matrix →
3	Rx(Matrix
4	N/u
5	Gnd
6	N/u
7	N/u
8	N/u
9	N/u

Baud rate 9600

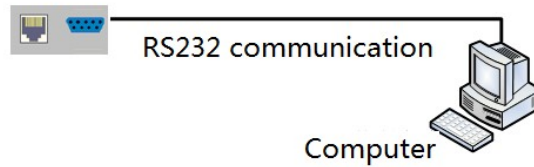

- RS232-2 and IR-EXT ports are reserved for future development

4.2 Ethernet control and connection

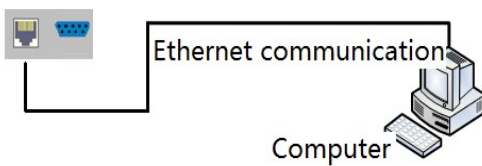

Note: Factory default network setting:

IP Type	Static IP
Static IP	192 . 168 . 0 . 247
Subnet Mask	255 . 255 . 255 . 0
Gateway	192 . 168 . 0 . 1

5 PC tool user guide

5.1 Account's authentication

When you run the PC tool, there needs password to authenticate.

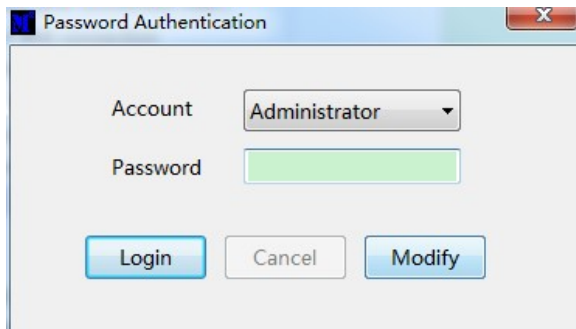

A screenshot of a 'Password Authentication' dialog box. The title bar reads 'Password Authentication' with a close button (X). The dialog contains two fields: 'Account' with a dropdown menu set to 'Administrator' and 'Password' with a green input field. At the bottom, there are three buttons: 'Login' (highlighted in blue), 'Cancel', and 'Modify'.

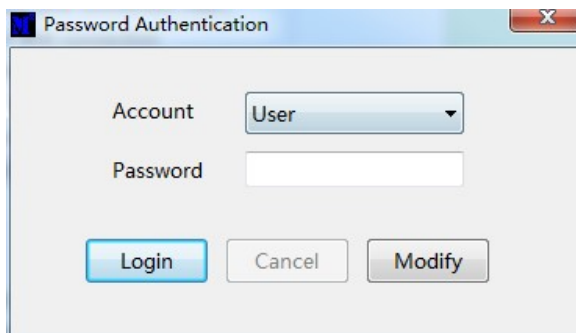

A screenshot of a 'Password Authentication' dialog box. The title bar reads 'Password Authentication' with a close button (X). The dialog contains two fields: 'Account' with a dropdown menu set to 'User' and 'Password' with a white input field. At the bottom, there are three buttons: 'Login' (highlighted in blue), 'Cancel', and 'Modify'.

Default password of Administrator (access to all features): 111111

Default password of User (access to all features, except OSD function): 000000

NOTE: In case of password lost, there's a admin password to login and modify password: Smartsecuri@2010

5.1.1 Password modification

1. Click drop-down list to select account: Administrator or User.
2. Input current password, then click the 'modify' button to authenticate.
3. Input new password twice, then click the 'modify' button.

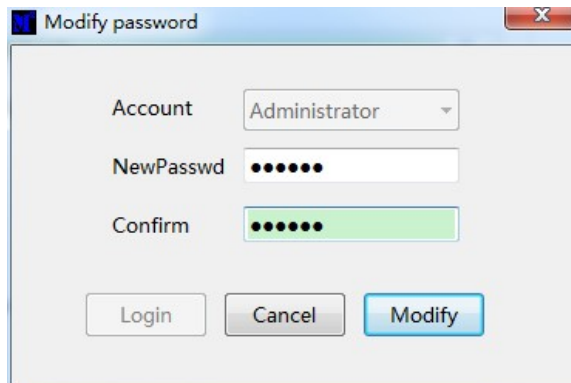

A screenshot of a 'Modify password' dialog box. The title bar reads 'Modify password' with a close button (X). The dialog contains three fields: 'Account' with a dropdown menu set to 'Administrator', 'NewPasswd' with a white input field containing six black dots, and 'Confirm' with a green input field containing six black dots. At the bottom, there are three buttons: 'Login', 'Cancel', and 'Modify' (highlighted in blue).

5.2 Connect with PC tool

1. The default PC tool's UI style as bellow

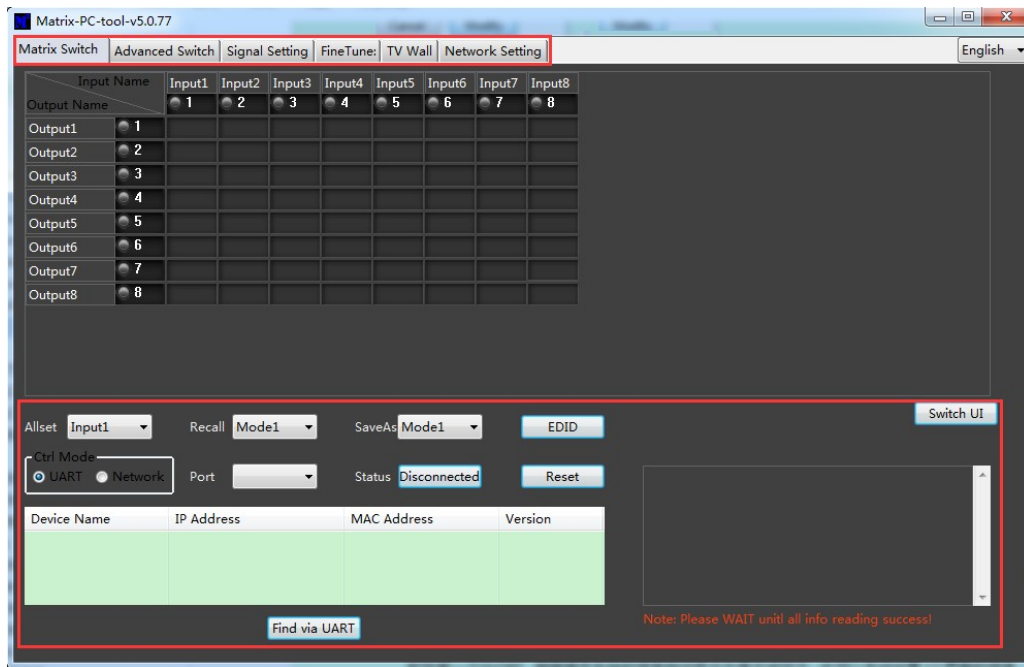

2. User can select **UART** (with RS232 cable) or **Network** to connect, baud rate is 9600 bps
3. **Network** control (with cat5/6 cable, default IP address, 192.168.0.247), follow below steps:
 - a) Query IP address info via UART, please refer to **Appendix A**.
Or query IP address info via Network, please refer to **Appendix B**.
 - b) Set IP info via UART, please refer to **Appendix C**.
Or set IP info via Network, please refer to **Appendix D**.
 - c) Set IP address on Windows 7/XP, please refer to **Appendix E**.
 - d) User can **directly connect via Ethernet cable** (please refer to **Appendix F**),
Or connect via network route/switch (please refer to **Appendix G**)
 - e) Click **Connected** button to setup link and connect.
4. When connect with PC Tool, User sometimes may encounter connection failure, please refer to **Appendix H**, Troubleshoot with Network control to fix.

5.3 Matrix Switch page

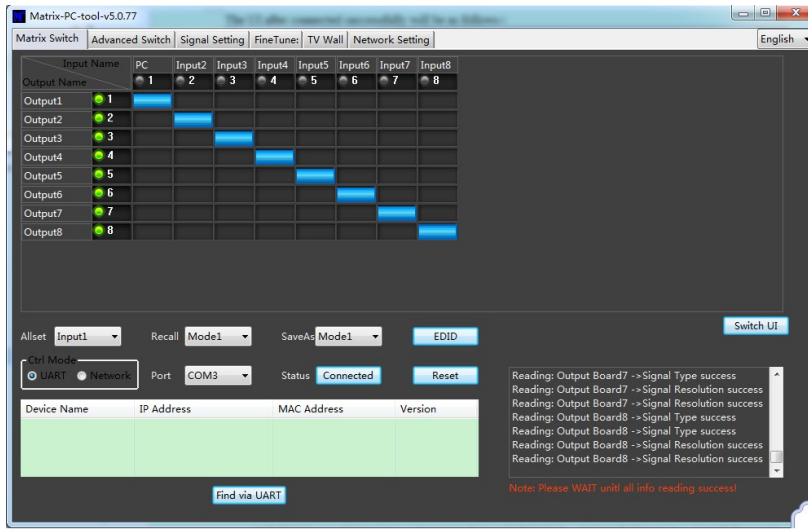

1. There are 3 options for Matrix Switch page, users can press Switch UI button to change the UI style.
2. There is a shortcut button to switch one input port to all output ports, that is Allset.
3. For example, switch input 1 to all outputs, user can select.

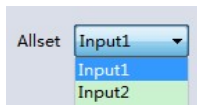

4. Recall mode: Recall a inputs/outputs routing scene which already be saved previously. The device supports maximum of 8 scenes.
5. Save mode: Save current inputs /outputs routing in one index. Maximum 8 modes supported. Note: Save/Recall here button here works the same with front panel save/recall control
6. System reset: The PC tool support reset system to recover to factory configuration.
7. EDID Control: Click the 'EDID' button on Matrix Switch page, then opens a EDID control window

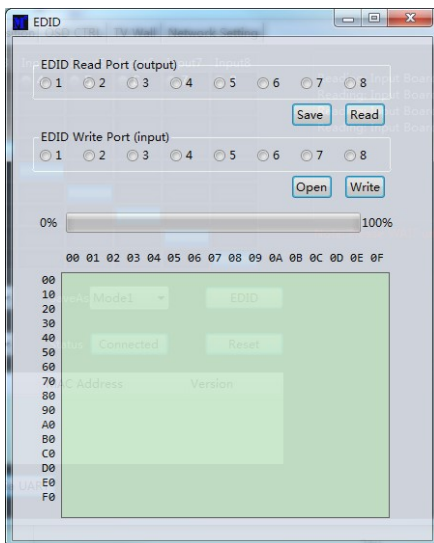

- a) Read EDID: Select the output port , then click the 'Read' button to read EDID.
- b) Write EDID: First read a EDID from output port, or open a EDID file that saved before, then select
- c) the input port, and click the 'Write' button to write EDID.
- d) Save EDID: After reading EDID successfully, Click 'Save' button to save
- e) This EDID for one input port is act as the Manual EDID, which can be selected or deselected .
- f) by the front panel

5.4 Signal Setting page

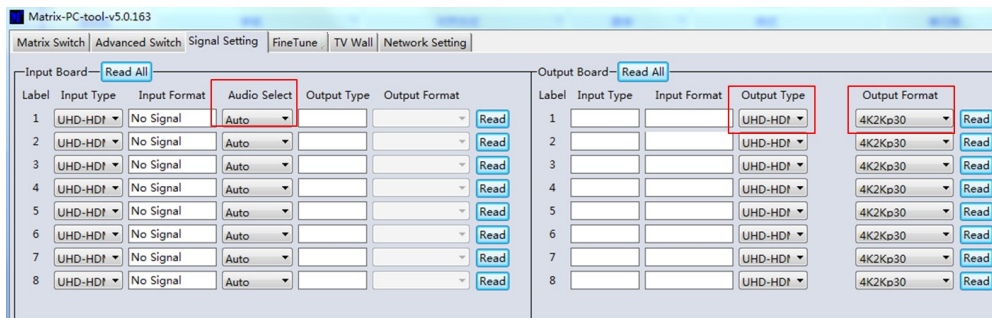

1. Audio Select

There are two options for input Audio Select:

- a) Auto: If the input source is HDMI signal, system will get the embedded audio, and if the input source is DVI signal, the system will get the corresponding analog audio
- b) External: System will get the corresponding analog audio

2. Output type

There are four options for input Output Type:

- A. UHD-HDMI (HDCP OFF): HDCP Off
- B. UHD-DVI
- C. UHD-HDCP-1.4,
- D. UHD-HDCP-2.2

3. Output Format

User can set output resolution here:

- 1) 3840x2160@60
- 2) 3840x2160@50
- 3) 3840x2160@30
- 4) 3840x2160@25,
- 5) 1920x1200@60
- 6) 1920x1080@60
- 7) 1920x1080@50
- 8) 1600x1200@60
- 9) 1400x1050@60
- 10) 1366x768@60
- 11) 1360x768@60
- 12) 1280x1024@60
- 13) 1280x768@60
- 14) 1280x720@60
- 15) 1280x720@50
- 16) 1024x768@60

5.5 Fine Tune

User can read and set the brightness/contrast/saturation/sharpness of each output.

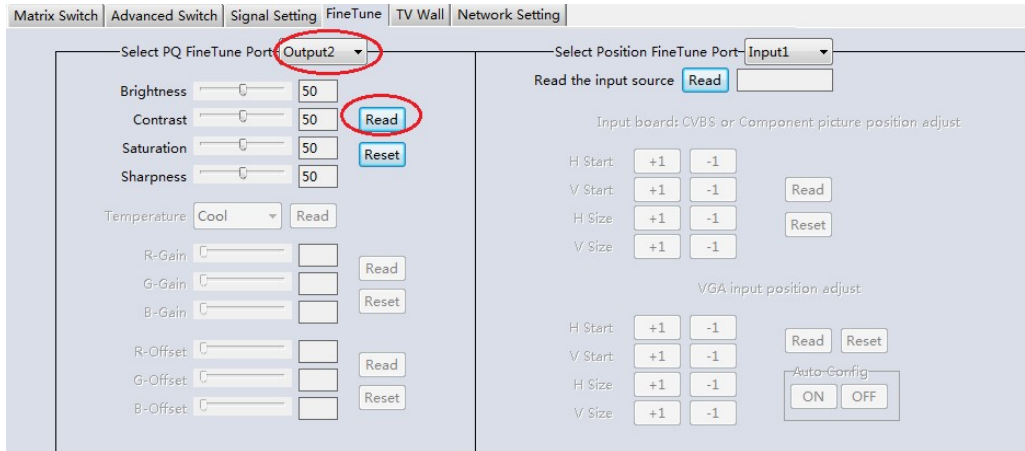

NOTE:

If none special occasions, do not change the default settings;

If there is a problem after the change, click Reset to return to the factory settings.

5.6 Video Wall

Set the Video wall display quantity , rows and columns of panels to be layout

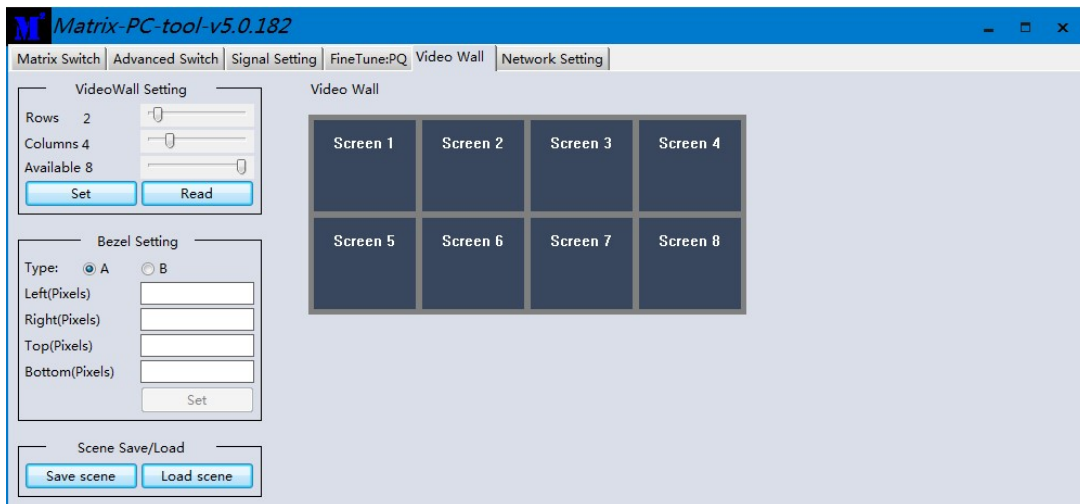

5.6.1 Build a wall

Select one screen, right click, can see a menu as the following picture shows:

- Input Select: Select the input port, for the displayer to display (Input 1 ~ Input 8);
- Output Select: Set the output port that connect to the display, need set according to the Video wall connect status; It means which output port connect to the display;
- Output Format: Set the output resolution;

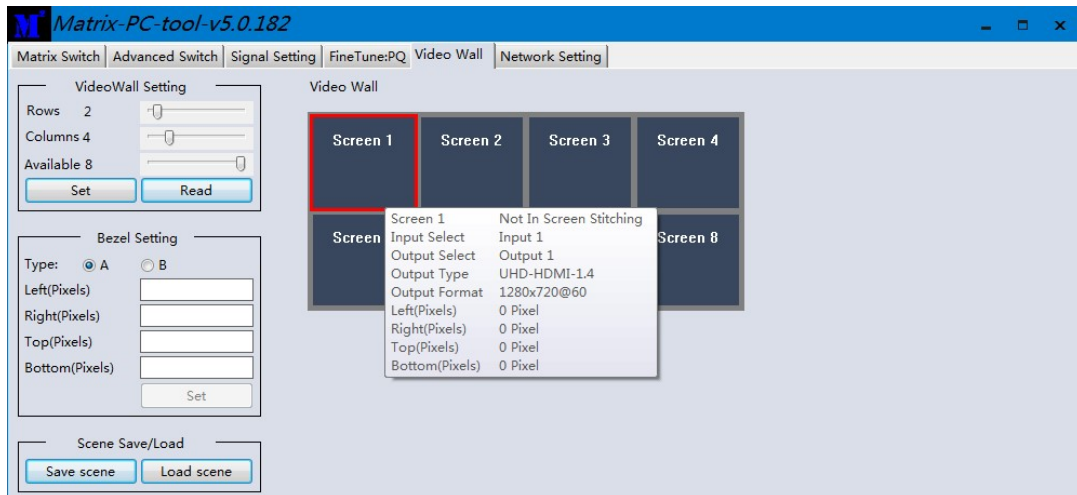

Click to select the screen, then drag, select the screens to splice, right-click, and click Screen Stitching to splicing;

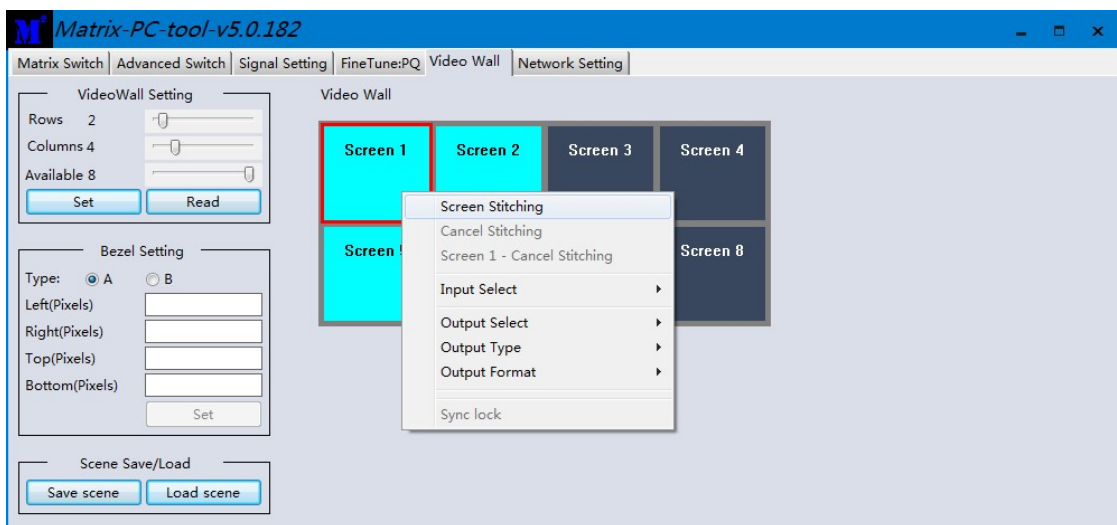

To cancel Video WALL, first select the wall which is splicing, right click, then select **Cancel Stitching**.

5.6.2 Bezel adjust

There are two options to set bezel:

Type A with pixels setting, maximum number is 255, see below:

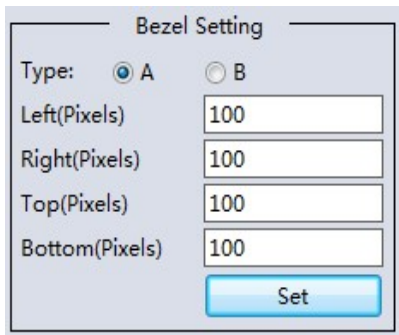

The screenshot shows a dialog box titled "Bezel Setting". It has two radio buttons for "Type": "A" is selected, and "B" is unselected. Below the radio buttons are four input fields: "Left(Pixels)" with value "100", "Right(Pixels)" with value "100", "Top(Pixels)" with value "100", and "Bottom(Pixels)" with value "100". At the bottom right of the dialog is a blue "Set" button.

Type B with millimeter setting, see below:

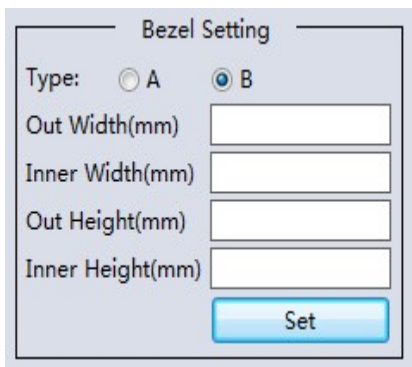

The screenshot shows a dialog box titled "Bezel Setting". It has two radio buttons for "Type": "A" is unselected, and "B" is selected. Below the radio buttons are four input fields: "Out Width(mm)", "Inner Width(mm)", "Out Height(mm)", and "Inner Height(mm)". At the bottom right of the dialog is a blue "Set" button.

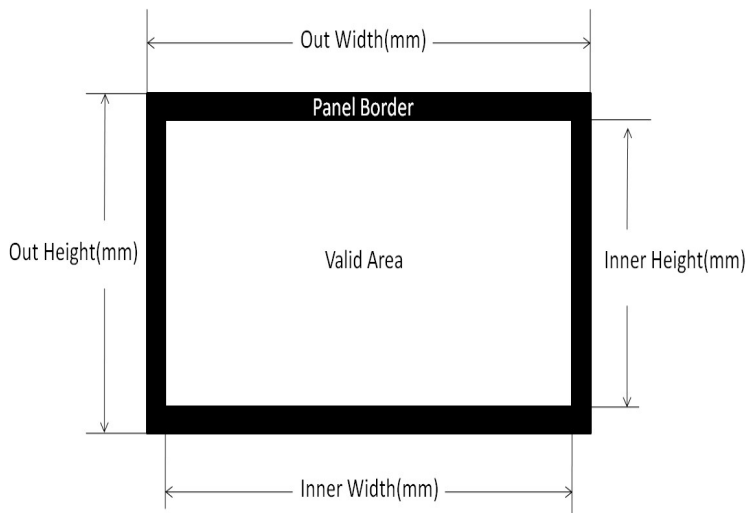

5.6.3 Multi Video wall

SX-8800 support several Video walls at the same time, for example it support one 2x2 wall and one 2x1 wall.

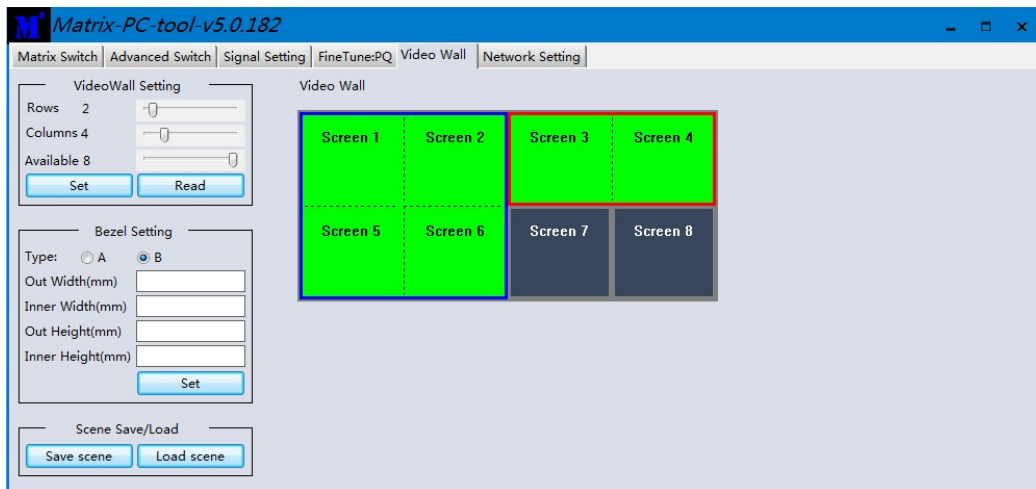

Each wall has its own bezel setting. Click one wall and then set bezel one by one

5.6.4 Multi View with TV Wall

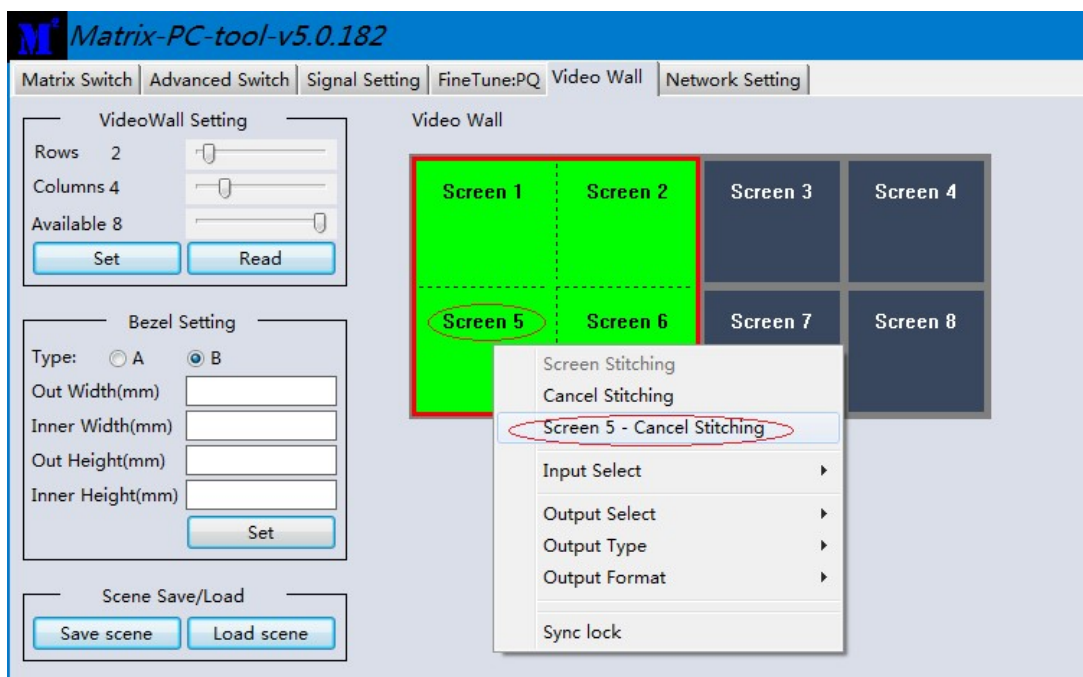

Above is one 2x2 wall, for example. If want screen 5 to separately display another video source, user can select **Screen 5 - Cancel Stitching**, then select the same or another video source for screen 5 to display. This separate screen is a full display screen

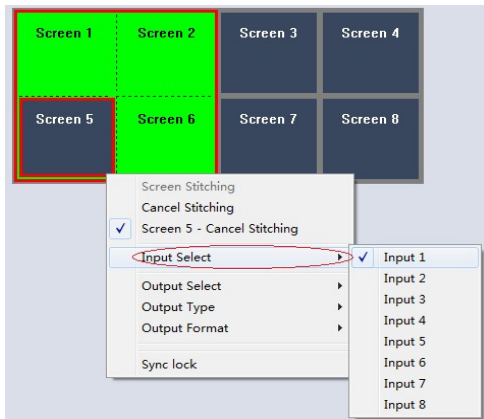

Multi View with Video Wall

5.6.5 Save scene/ Load scene

On the Video wall page, user can save or load one splicing wall scene , including input/output routing and wall layout.

5.7 Advanced route switch page

Please refer to Appendix I for this section.

6 Control via Web

- 1) Directly Input the IP address in the web browser, then press 'Enter' key.
- 2) Input the username: admin.
- 3) Input the password: admin.
- 4) Login and then you can control the matrix switch function use the website.
- 5) Please note, on website control, user only can control basic operation.

7 Electrical parameters

Electrical parameter	
Interface	HDMI-A
HDMI /DP /VGA Version	HDMI2.0,HDCP2.2
Bandwidth	18Gbps
Input	800x600@60Hz,1024x768@60Hz, 1280x768@60Hz, 1280x800@60Hz,1280x1024@60Hz,1360x768@60Hz, 1366x768@60Hz,1400x1050@60Hz,1440x900@60Hz, 1600x1200@60Hz,1680x1050@60Hz, 1920x1200@60Hz,480p,576p,720p,1920x1080i, 1920x1080p,3840x2160@24Hz/25Hz/30Hz/50Hz/60Hz, 4096x2160@24Hz/25Hz/30Hz/50Hz/60Hz.
Output	3840x2160@60Hz, 3840x2160@50Hz, 3840x2160@30Hz, 3840x2160@25Hz, 1920x1200@60Hz,1920x1080@60Hz, 1920x1080@50Hz,1600x1200@60Hz, 1400x1050@60Hz,1366x768@60Hz, 1360x768@60Hz, 1280x1024@60Hz, 1280x768@60Hz, 1280x720@60Hz, 1280x720@50Hz, 1024x768@60Hz
HDMI Amplitude	T.M.D.S +/- 0.4Vpp
Differential impedance	100±15ohm
RS232/Ethernet control	
Baud rate and protocol	Baud rate: 9600, data bit : 8, stop bit: 1,no parity checking
Ethernet	IE10.0+,HTML5
Power	
Max Consumption	100W, 110-240VAC
Matrix Mechanical dimensions	
Size(mm)	430(L)X300(W)X44 (H)
Weight	5Kg
Operating temperature	0 to 40°C
Storage temperature	-20 to 70°C
Permissible humidity	10%-50%

7. Package Contents

Item	Quantity
SX-8800 4K UHD Matrix / Video Wall Solution	1
User Manual	1
AC Power Cord	1

8 Appendix A: Query IP info via UART

Method A: After connected to the device via UART, Click the 'Find via UART' button at 'Matrix Switch' page to read the IP information.

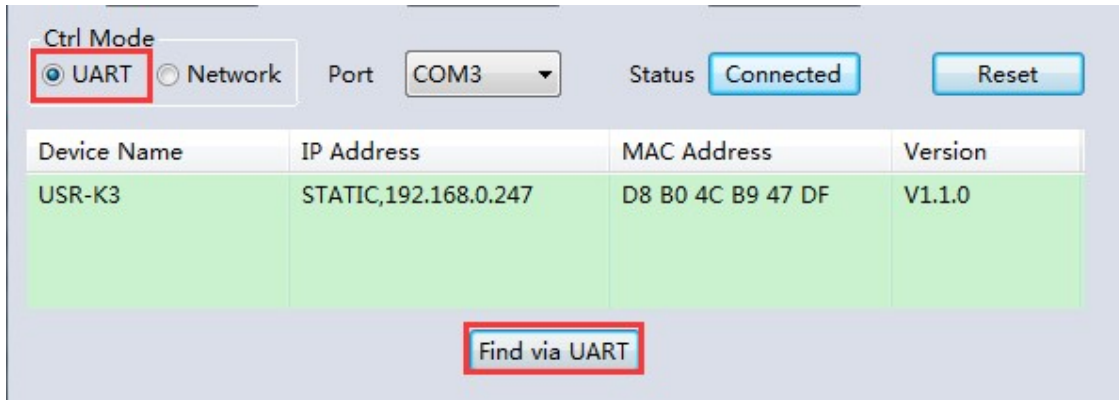

Method B: After connected to the device via UART, Click the 'Find via UART' button at 'Network Setting' page to read the IP information.

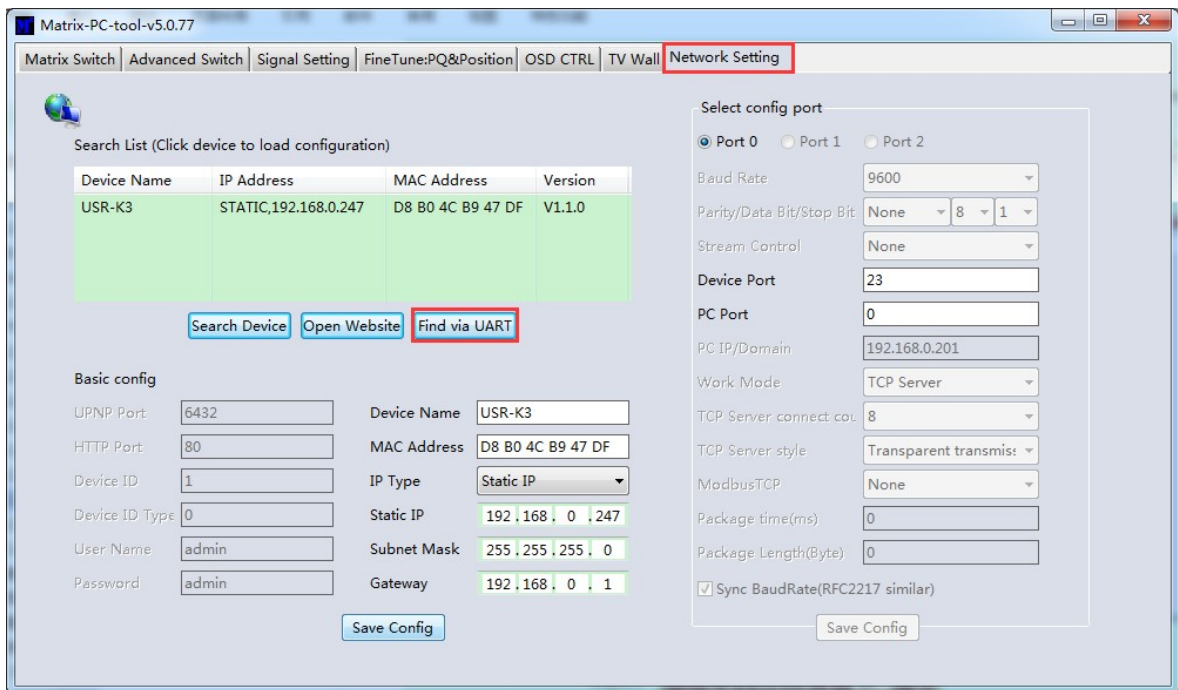

9 Appendix B: Query IP address info via Network

After connecting to the device via network, we can query information as follows.

Method A: Switch to 'Matrix Switch' page, then click 'Search Device' button to query IP address information.

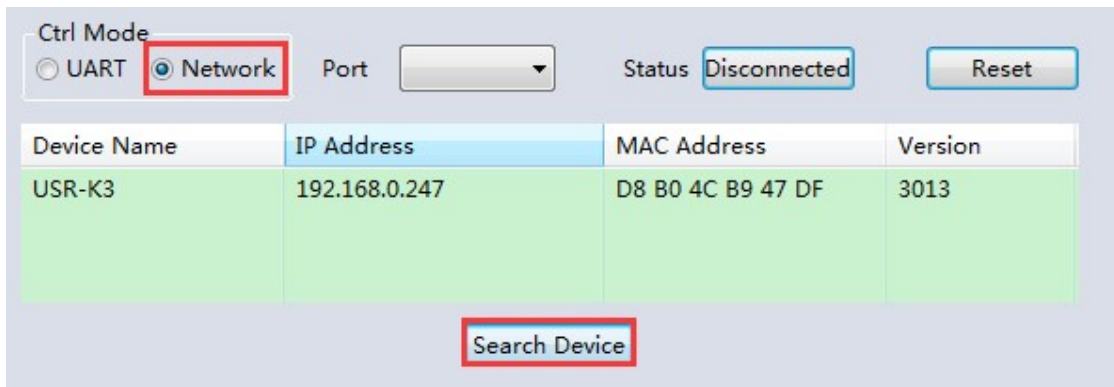

Method B: After switching to 'Network Setting' page, click 'Search Device' button to search devices, then click one device in the result list to load its IP address information.

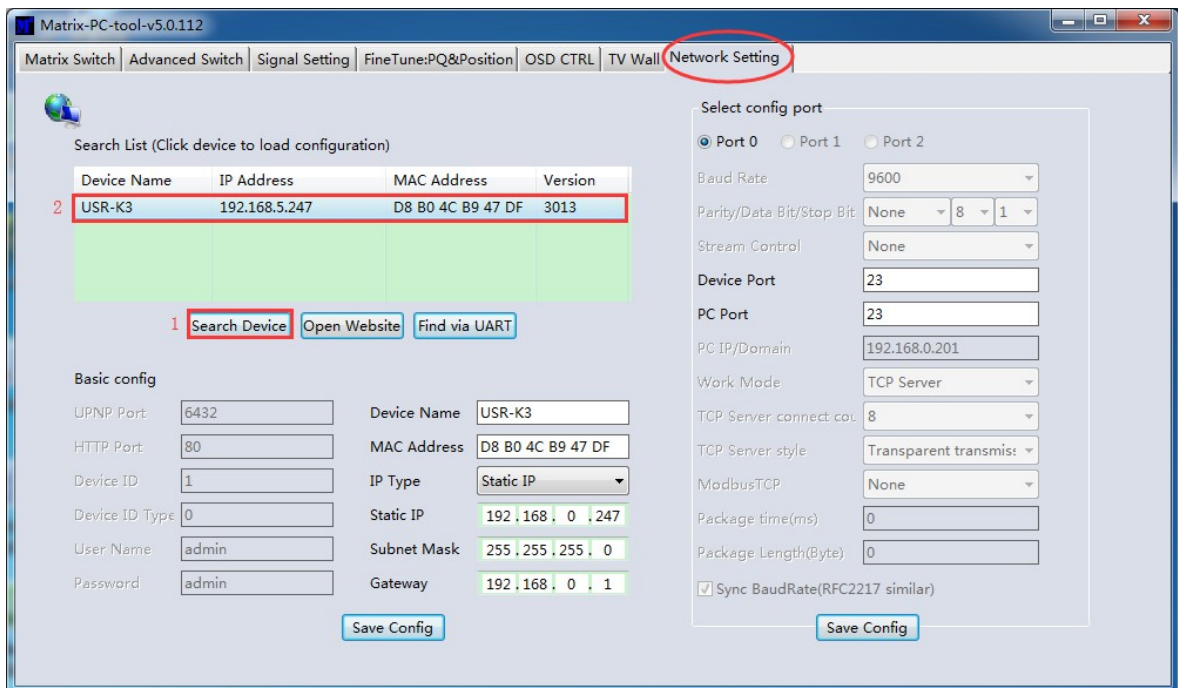

10 Appendix C: Set IP info via UART

After connected to the device via UART, switch to 'Network Setting' page:

1. Click 'Find via UART' button to read IP information
2. Modify IP address type to Static IP or Auto IP(DHCP). If IP address type modified to Static IP, then input IP address, subnet mask and gateway information.
3. Click 'Save Config' button to save.
4. Click 'Find via UART' button again to read IP information to make sure the modification is successful.

11 Appendix D: Set IP info via Network

After connecting to the device via network, we can query information as follows.

- a) Switch to 'Network Setting' page, then click the 'Search Device' button to search devices.
- b) Click the device you want to configure in the result list (When you click it, the software will read the network configuration of the device automatically)
- c) Modify the IP address or the IP address type or other configuration.
- d) Click the 'Save Config' button to save data.
- e) When the software shows a message of 'Success', click 'Search Device' button to load configuration again to make sure your modification is saved successfully.

12 Appendix E: Set IP address on Windows 7 or XP

1. Windows 7: Open 'Network and Sharing Center':

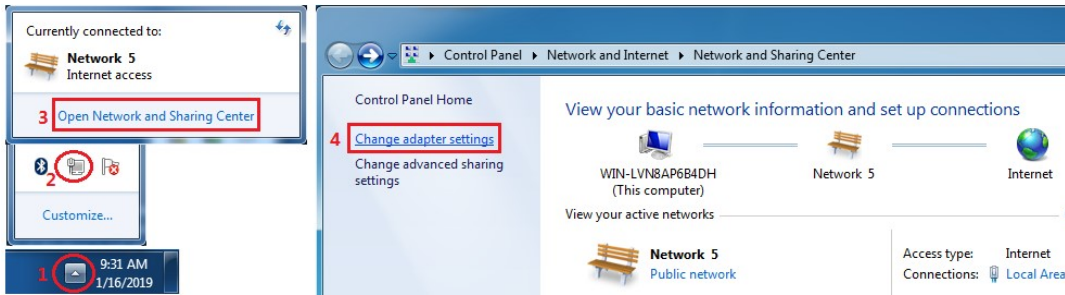

Modify static IP address: (e.g. 192.168.0.1):

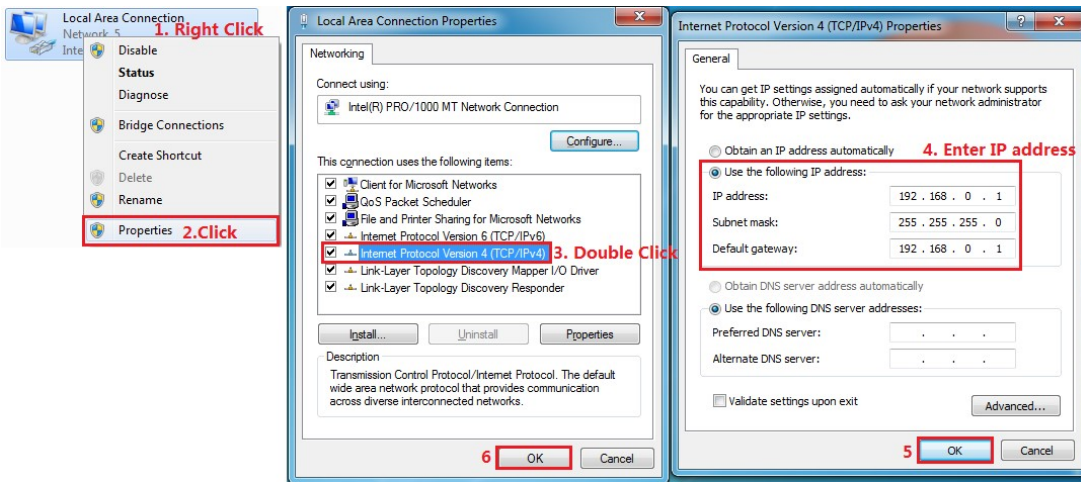

2. Windows XP: Open 'Network Connections':

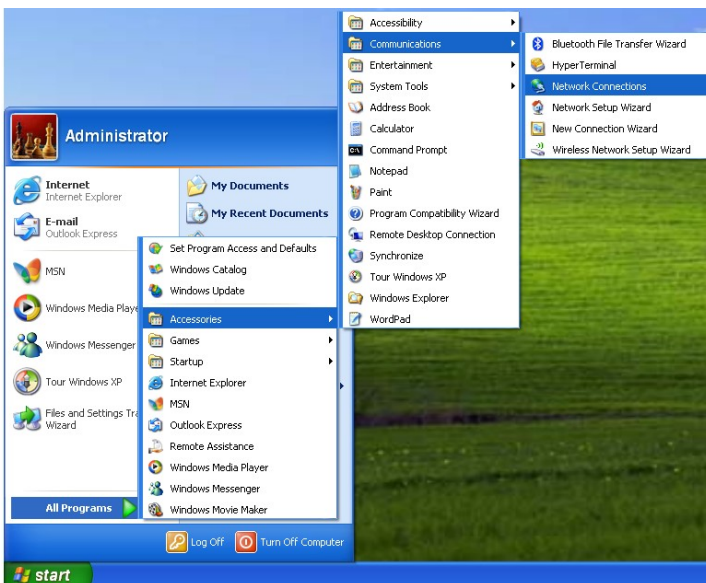

Modify IP address of 'Local Area Connection': (e.g. 192.168.0.1):

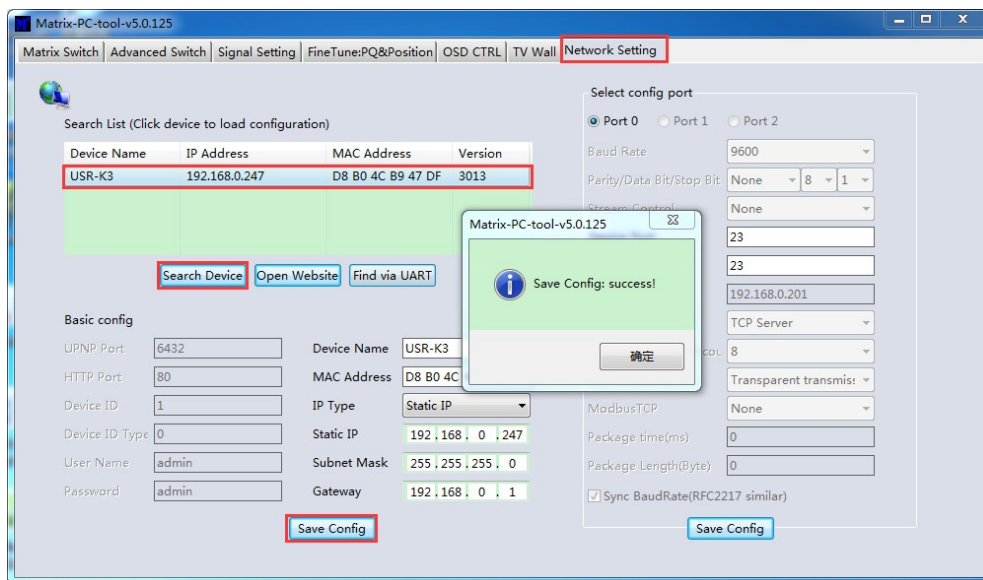
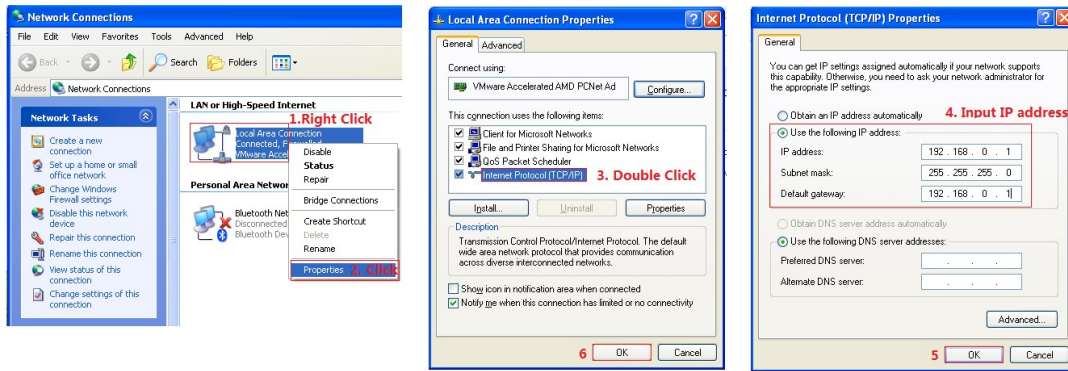

NOTE:

1. When selecting the device, it will display the matrix's network board information. User can edit the device's name, in order to better identify matrix. User can set dynamic IP/ static IP, subnet mask, gateway and other network information. At the same time, user can also set the device port. Serial port baud rate is 9600 (the user cannot change the baud rate, otherwise it will lead to the network control failed).
2. Configuration via UART only support modify IP address or IP address type. If you want to modify other configuration, please configure it via Network

13 Appendix F: Direct connect via Ethernet cable

Operation steps are as follows:

- 1) Connect the PC and device directly via an Ethernet cable.
- 2) Manually setting up the IP address of the PC, and the IP address of the PC and the device should be in a same network segment (The default IP address of the device is 192.168.0.247, and the default network mask of the device is 255.255.255.0).
- 3) Run the PC control software (**If the IP address of the PC changed after running the software, you should close it and run it again**)
- 4) Click to switch 'Ctrl Mode' to 'Network'.
- 5) Click the 'Search Device' button
- 6) Click the device you want to control in the result list (When you click it, the software will read the network configuration such as network port and so on of the device automatically)
- 7) Click the 'Disconnected' button (which is right to 'Status')
- 8) After connected successfully, the button right to 'Status' will be 'Connected' (If you click it now, it will disconnect from the device)



Note: The default IP address is 192.168.0.247, and the default subnet mask is 255.255.255.0

14 Appendix G: Connect via network route /switch

Operation steps are as follows:

- 1) Connect the PC and the device to a same network router.
- 2) Setting up the IP address of the PC. Either manual (Static) mode or automatic (DHCP) mode
- 3) Just make sure the IP address of the PC and the device are in a same network segment(When the IP type is obtained automatically, the network router that PC and device connected to should support HDCP function)
- 4) Run the PC control software(**If the IP address of the PC changed after running the software, need close it and run it again**)
- 5) Click to switch 'Ctrl Mode' to 'Network'.
- 6) Click the 'Search Device' button
- 7) Click the device you want to control in the result list (When you click it, the software will read network configuration such as network port and so on of the device automatically)
- 8) Click the 'Disconnected' button (which is right to 'Status') to connect to the device.
- 9) After connected successfully, the button right to 'Status' will be 'Connected' (If you click it now, it will disconnect from the device)

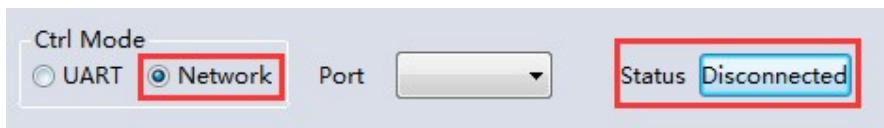

NOTE: If the IP type of the device is Dynamic (DHCP) mode, the network route or switch must support HDCP function, otherwise the device will not be able to obtain a valid IP address and this will cause device not be found. If the device can be found but not able to connected successfully, please make sure the IP address of the PC and the device are in a same network segment. (e.g. when subnet mask is 255.255.255.0, then 192.168.0.1 and 192.168.0.2 are in a same network segment)

15 Appendix H: Troubleshoot with Network control

- 1) Unable to find the SX-8800 on the network:
 - a) Cause A: The IP address type of the device is obtained automatically (DHCP), but currently connected direct via Ethernet cable or connected to a network device(router or switch and so on) which not support HDCP function.
Solution A: Setting up the IP address type of the device to static mode or connecting the device to a network router which support HDCP function.
 - b) Cause B: The device is not power on.
Solution B: Please power on the device.
 - c) Cause C: The Ethernet cable is bad contact.
Solution C: Check the Ethernet cable's connection whether is ok.
 - d) Cause D: The IP address type of the PC is obtained automatically(DHCP), but currently connected direct via Ethernet cable or connected to a network device(router or switch and so on) which not support HDCP function.
Solution D: Setting up the IP address type of the PC to static mode or connecting the device to a network router which support HDCP function.
 - e) Cause E: Unknown
Solution E: When using direct connection via Ethernet cable, please setting up the IP address type both of the PC and the device to static mode, and the IP address of both should be in a same network segment. Or when using connection via LAN, connect the PC and the device to a same network router which support HDCP function.

- 2) The software shows a message of 'device response timeout' after connected to the device.
Cause A: The IP address of the PC and the device are not in a same network segment.
Solution A: Setting up the IP address of both, make sure the IP address are in a same network segment.

- 3) The software shows a message of 'TCP connection failed! Error Code: xxxx' after connected to the device.
 - a) Cause A: The IP address of the PC and the device are not in a same network segment.
 - b) Solution A: Setting up the IP address of both, make sure the IP address are in the same network segment.
 - c) Cause B: Firewall is enabled, and PC tool is not admitted through.
 - d) Solution B: Disable firewall or add PC tool to white list so can switch can pass through.

Note: If the device's IP address type is Auto (DHCP), it cannot be connected to the device via UART, click the 'Find Via UART' button to read the device's IP address. If the IP address of the device is 255.255.255.255, it means that the network device (the device connected to) does not support HDCP function.

16 Appendix I: Advanced routing switch

PC tool support automatically switch the input source periodically for the output port in order to facilitate the demonstration functions needed in some scenarios.

Operation guide is as follows:

1. Click the output port that need configure (Also user can press 'Ctrl' or 'Shift' first ,then click to select more output ports)

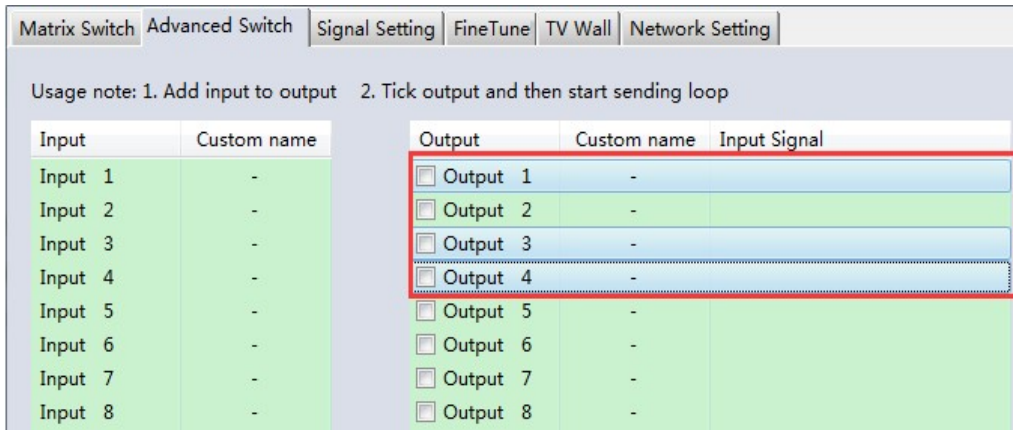

2. Press 'Ctrl' or 'Shift' first, then click to select input ports

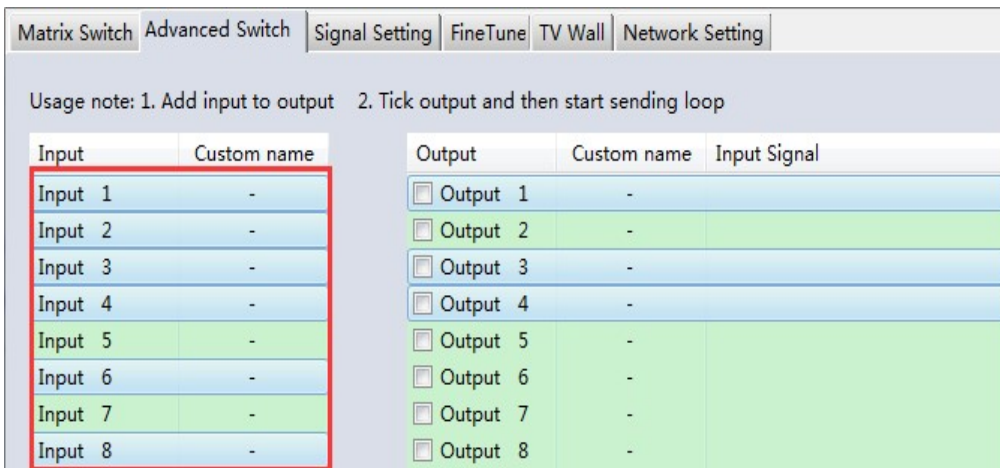

3. Click "-->" button to add the input ports selected in step 2 .

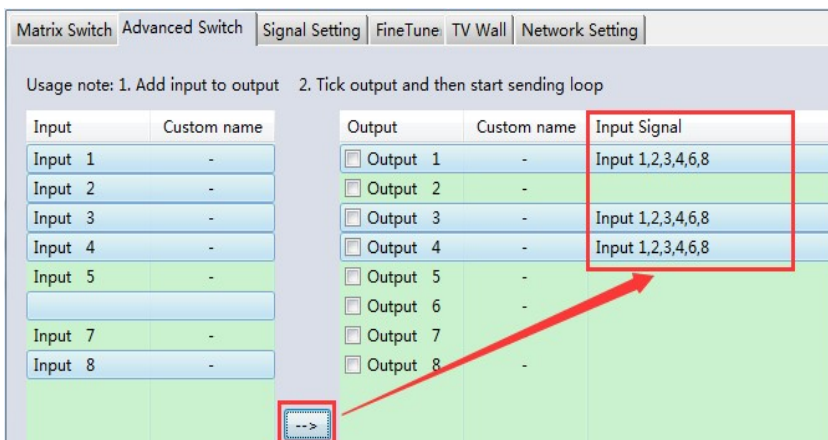

4. Check the output ports that need to automatically switch input source periodically.

Matrix Switch | **Advanced Switch** | Signal Setting | FineTune | TV Wall | Network Setting

Usage note: 1. Add input to output 2. Tick output and then start sending loop

Input	Custom name	Output	Custom name	Input Signal
Input 1	-	<input checked="" type="checkbox"/> Output 1	-	Input 1,2,3,4,6,8
Input 2	-	<input type="checkbox"/> Output 2	-	
Input 3	-	<input checked="" type="checkbox"/> Output 3	-	Input 1,2,3,4,6,8
Input 4	-	<input checked="" type="checkbox"/> Output 4	-	Input 1,2,3,4,6,8
Input 5	-	<input type="checkbox"/> Output 5	-	
Input 6	-	<input type="checkbox"/> Output 6	-	
Input 7	-	<input type="checkbox"/> Output 7	-	
Input 8	-	<input type="checkbox"/> Output 8	-	

5. Configure automatic switching.

Switch frequency: default 2000ms

All outputs send combine: default not checked.

- unchecked: Switch all output ports one by one.
- checked: Switch all output ports' input at the same time in a switch operation.
- NOTE: Switch one input one by one if there are many input ports selected.

Wait others to finish then start next loop: Only can be set when 'All outputs send combined' is checked.

- unchecked: When the number of the selected input ports of some output is not the same, immediately start next loop when one output finished a switching loop.
- checked: All outputs start a new loop together. When the number of the selected input ports of some output is not the same, not start next loop until other outputs finish the current switching loop.

Send cmd only one loop: stop automatically switch when a loop is finished.

Select all outputs: Quickly check or uncheck all output ports.

Send cmd periodically at ms

All outputs send combined

Wait others finished then start next loop

Send cmd only one loop

Select all outputs

- Click 'Start' button to start automatically periodically switch.
- Automatically periodically switch is ongoing...
Click 'Stop' button to stop automatically periodically switch if needed. If 'Send cmd only one loop' is checked, it will stop after one loop is finished.

If you have further questions, please contact your PureLink dealer, call PureLink at 201-488-3232, or visit www.purelinkav.com

