



**NETWORK
TECHNOLOGIES
INCORPORATED**

1275 Danner Dr Tel:330-562-7070
Aurora, OH 44202 Fax:330-562-1999
www.networktechinc.com

UNIMUX™ Series

UNIMUX-USBV-x0

USB KVM Switch

Installation and Operation Manual



UNIMUX-USBV-80-RS (Front and Rear View)

TRADEMARK

UNIMUX is a trademark of Network Technologies Inc in the U.S. and other countries

COPYRIGHT

Copyright © 2000, 2017 by Network Technologies Inc. All rights reserved. No part of this publication may be reproduced, stored in a retrieval system, or transmitted, in any form or by any means, electronic, mechanical, photocopying, recording, or otherwise, without the prior written consent of Network Technologies Inc, 1275 Danner Drive, Aurora, Ohio 44202.

CHANGES

The material in this guide is for information only and is subject to change without notice. Network Technologies Inc reserves the right to make changes in the product design without reservation and without notification to its users.

Application Note: This manual applies to UNIMUX-USBV-xO switches made on or after October 1, 2004.

Typographic Conventions

The table below offers examples of text format and its meaning when that format is used in place of the standard font (Helvetica) used throughout this manual.

Typeface meaning	Font Configuration	Example
On-screen computer output	Courier New-(not bold)	C:>
What you type on the computer	Courier New-bold	C:> edit text.bat

TABLE OF CONTENTS

INTRODUCTION.....	1
MATERIALS	2
DEFINITIONS.....	2
FEATURES AND FUNCTIONS.....	3
RACKMOUNTING INSTRUCTIONS.....	4
To Mount to a Rack	4
INSTALLATION.....	5
Power-Up Sequence.....	7
Limitations.....	7
USING THE UNIMUX USB KVM SWITCH	8
Front Panel Control.....	8
Keyboard Control.....	8
MODES OF OPERATION	9
Basic Command Mode	9
Scan Mode.....	9
Broadcast Mode.....	10
Normal Mode	10
No SUN Sleep Mode	10
Select Country Code.....	10
Mice and Trackballs with MACs.....	11
OSD CONTROL.....	12
Security Option	12
Enabling the Security Feature	12
User Login Mode.....	13
ADDITIONAL MODES AVAILABLE WITH SECURITY	14
Administration Mode	14
Administrator Password.....	14
User Name List	15
Edit User	15
Alternate Command Hot Key	16
Usage Statistics	17
USER ACCESS FUNCTIONS.....	18
OSD Command Mode	18
Broadcast Mode.....	19
Scan Mode.....	19
Normal Mode	20
Edit Mode.....	20
Change Settings	21
Select Ports For Broadcast.....	21
Select Ports For Scan.....	22
Language Selection	22
MAC Ports Configuration	22
Search Mode.....	23
Maintenance Mode	24
Help Mode.....	25
F3- Display Information.....	25
RS232 CONTROL.....	26
RS232 Connections and Configuration	26
Remote Connection	26
Baud Rate.....	26
Unit Address and Loop Back.....	27
Command Protocol.....	27
NTI Switch Control Program For Windows 9X, NT, 2000, XP, Vista,7, 8 and 10	29
SerTest- RS232 Interface Test Program	29
Main Options.....	29
MOUSE CLICK EQUIVALENTS	31
KEYBOARD FEATURES	31

Keyboard-To-Computer Translation	31
Translation Capabilities	31
Translation Tables	31
International Sun Keyboards	32
CASCADING	33
Configuration	33
Cascaded Installation	33
Limitations.....	35
Port Assignments in OSD.....	36
AUDIO SUPPORT.....	37
TROUBLESHOOTING	37
RS232 Connection Cables.....	38
Pinout of RS232 port on UNIMUX	38
Specifications for Straight-Through Serial Cable for CPU Connection	38
INDEX.....	39
WARRANTY INFORMATION.....	39

TABLE OF FIGURES

Figure 1- Secure rackmount ears to switch.....	4
Figure 2- Secure switch to a rack.....	4
Figure 3- Connect a VGA multi-scan monitor	5
Figure 4- Connect the device(s).....	5
Figure 5- Connect the AC line cord.....	6
Figure 6- Connect each CPU	6
Figure 7- Compatible device combinations	7
Figure 8- Country Codes for international SUN keyboards.....	10
Figure 9- Administrator Login screen	12
Figure 10- User Login screen.....	13
Figure 11- Administration Mode menu	14
Figure 12- Administrator password change	14
Figure 13- User Name List screen	15
Figure 14- Edit the user access list	15
Figure 15- Alternate Command Hot Key	16
Figure 16- Usage Statistics screen	17
Figure 17- Command Mode screen	18
Figure 18- More Command Mode features	19
Figure 19- Edit Mode screen.....	20
Figure 20- Change Settings menu	21
Figure 21- Select ports for broadcasting.....	21
Figure 22- Select ports for scanning	22
Figure 23- Select the keyboard language	22
Figure 24- Configure Ports for MAC screen.....	23
Figure 25- Search Mode screen.....	23
Figure 26- Maintenance Mode screen	24
Figure 27- Information provided by the F3 command	25
Figure 28- RS232 DIP switches	26
Figure 29- RS232 connection with Matrix-Y-1 cable.....	27
Figure 30- Pinout of Matrix-Y-1 cable	27
Figure 31- RS232 Communication Illustrated	27
Figure 32- Keyboard Layouts	32
Figure 33- Connections for Cascading.....	33
Figure 34- Cascaded configuration with multi-user slaves	34
Figure 35- Master-to-slave device cable connections- single-user switches.....	34
Figure 36- Master to slave cable connections- multi-user switches.....	35
Figure 37- Slave Port Identification	36
Figure 38- Rear View of UNIMUX-USBV-40-A	37

INTRODUCTION

The UNIMUX-USBV-xO (formerly referred to as KEEMUX-USBV-xU) USB KVM switch (UNIMUX) allows access to any Windows, MAC, or SUN USB CPUs from one monitor, USB keyboard and USB mouse (up to 32 CPUs as a single switch or 512 CPUs when cascaded). Internal microprocessor circuitry allows all USB CPUs to be booted simultaneously without keyboard error. Port selection is accomplished by front panel push buttons or commands typed on the keyboard. Port lights and status LEDs continuously update on the front panel. Video formats up to 2048X1536 at 150MHz bandwidth can be displayed from all platforms.

Available Options

- Switch models are available in 60 or 50 Hz, and 110 or 220V.
- RS232- Control the switch(s) from the serial port of any CPU with an RS232 port. To order RS232- add "RS" to the model number (i.e. UNIMUX-USBV-xO-**RS**)
- Configuration is expandable by cascading switches
- Audio support to enable user to connect stereo speakers to receive audio signals from connected CPUs- add "-A" to the part number (model UNIMUX-USBV-4O-**A** (4,8,16 and 32 port models only))

Types of User Input Devices Supported:

- USB keyboard with Windows layout
- USB keyboard with SUN layout
- USB keyboard with MAC layout
- USB Mouse - (up to 3 buttons)
- USB IntelliMouse (scrollwheel)
- USB Hub
- Mouse-Trak trackball
- Logitech, Kensington and Microsoft Wheelmouse or Trackball on Mac CPUs with special drivers
- Logitech Cordless Elite Duo keyboard and mouse
- Logitech wireless (S510, EX110, diNovo, diNovo Edge, LX710)
- Logitech Cordless Desktop MX5000 Laser (967558-0403)
- Logitech Cordless Freedom Optical (967091-0403)
- Crystal Vision keyboard with touchpad
- Gyration keyboard/mouse
- VGA, XGA, SVGA, and most DVI monitors (when used with NTI DVIF-15HDM adapter)
- NTI USB-PS/2 Adapter
- NTI USB-SUN Adapter
- Belkin wireless F8E832-BNDL
- Kensington wireless (64379)
- MS Wireless Optical Desktop (3000 and 4000)
- MS Wireless Optical Desktop (X08-77995)
- HP P2360AA
- Fellowes wireless keyboard (KBR0108) with mouse (MSR0238T)
- Creative Desktop Wireless 8000
- Unotron Scrollseal Washable Optical Mouse (M11)
- Apple USB 2.0 Keyboard (MB110LL/A)
- Apple USB 2.0 Mouse (MB112LL/A)

Types of CPUs Supported:

Any USB CPU supporting USB version 1.0 or above including:

- USB Windows (all)
- USB MAC
- USB SUN

MATERIALS

Materials supplied with this kit:

- NTI UNIMUX-USBV-xO (x=2,4,8,16, or 32 ports) USB KVM Switch
- 110VAC or 220VAC at 50 or 60Hz-5VDC/2.0A AC Adapter
- Line cord, country specific
- Rack mount kit (4 and 8 port models only)

Materials *Not* supplied but **REQUIRED**:

- A USBVEXT-xx-MM cable for each USB CPU being connected to the switch must be used for monitor, keyboard and mouse interface.
- An SA-xx-MM cable with 3.5mm stereo plug on each end for each audio source to be connected (models with audio support only) SA-xx-MM cables are available from NTI in 3,6,10, 15, 25, 35, 50 and 100 foot lengths

where:

xx is the length of the cable in feet

MM indicates male-to-male connector

Cables can be purchased from Network Technologies Inc by calling **(800) 742-8324** (800-RGB-TECH) in the US and Canada or **(330) 562-7070** (worldwide).

DEFINITIONS

- USB Composite Device A USB device that contains multiple endpoints each representing input devices that cannot be separated (i.e. a keyboard with a built-in mouse)
- USB Hub A USB device that allows one or more USB input devices to plug in to the USB. The hub has exactly one upstream port with one or more downstream ports which input devices connect to
- CPU Enclosure that contains the operating system and processor (i.e. Sun with SPARCstation5, Windows 95 with Pentium II)
- Input Device Keyboard or Mouse
- System One or more CPUs connected to one or more switches controlled by one or more input devices

FEATURES AND FUNCTIONS

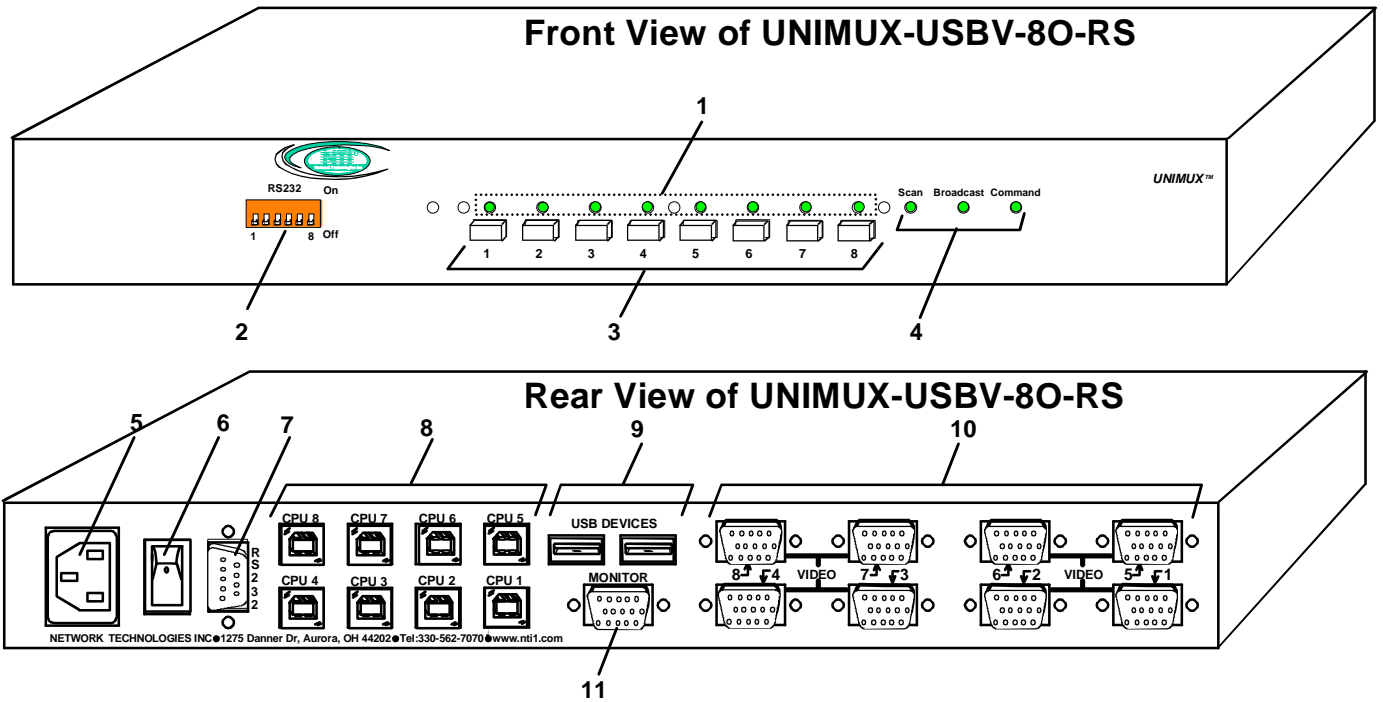

1. **CPU Status LEDs**- for visual indication of connection between the user and a specific CPU.
2. **RS232**- (optional) DIP switches for configuring switch address when RS232 is used
3. **CPU Select Switches**- push to manually switch to a specific CPU or change the switch operating mode
4. **Mode Status LEDs**- for visual indication of switch operating mode
5. **IEC Connector**- for attachment of country-specific power cord
6. **Power Switch**- to power up or power down the UNIMUX
7. **RS232**-(optional) 9DB male connector- for attachment of RS232 control cable
8. **CPU x**- USB type B female connector-for connection of USB device cable from CPU(s)
9. **DEVICES**- USB type A female connector- for connection of user USB device(s)
10. **VIDEO-x**- 15HD female connectors- for connecting video cables from CPUs
11. **MONITOR**- 15HD female connector- for connection of the user video monitor

RACKMOUNTING INSTRUCTIONS

This NTI switch was designed to be mounted to a rack or to sit on a desktop. It includes rackmount ears to make attachment to a rack easy, and rubber feet to be applied to the bottom of the case if it will instead sit on a flat surface. If this will sit on a flat surface, simply apply the rubber feet to the bottom of the case in each of the 4 corners.

To Mount to a Rack

1. Attach the ears to the switch using the 6-32x3/16" flat Phillips-head screws (6) provided as shown in the illustration below. The holes in the ears should line up with pre-threaded holes in the sides of the NTI switch. Tighten the screws securely.

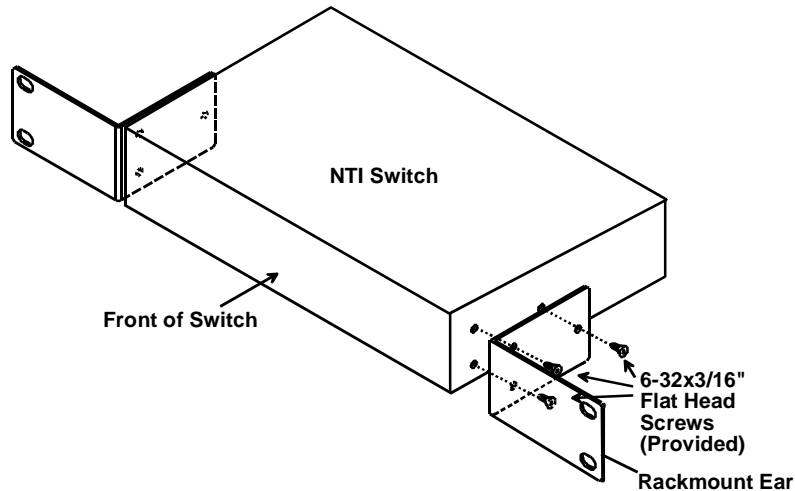

Figure 1- Secure rackmount ears to switch

2. Install 4 captive nuts (not provided) to the rack in locations that line up with the holes in the mounting ear on the NTI switch.
3. Secure the NTI switch to the rack using four 3/16" diameter screws (not provided). Each screw should be of sufficient length to go completely through the NTI mounting ear, rack frame and fully engage all threads in the captive nut. Be sure to tighten all mounting screws securely.
4. Attach all cables securely to the switch and where necessary supply adequate means of strain relief for cables.

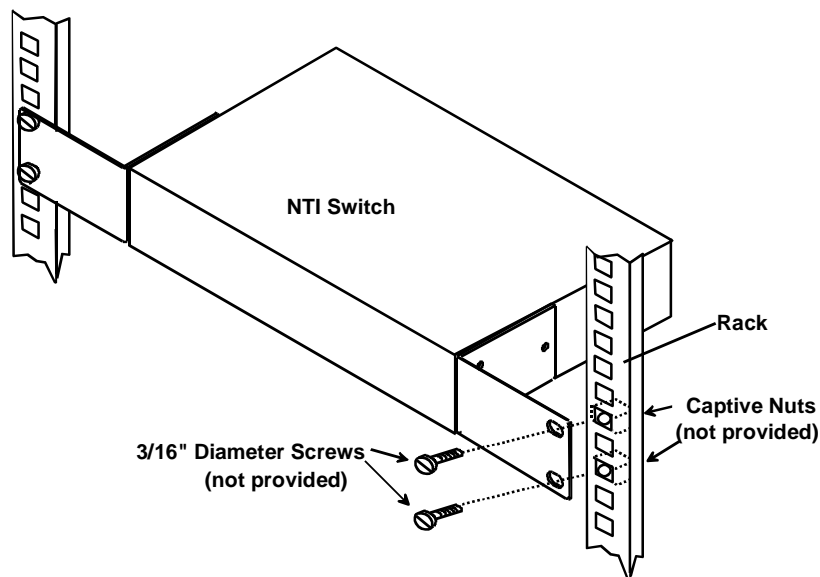

Figure 2- Secure switch to a rack

INSTALLATION

1. It is not necessary to turn the CPUs or monitors OFF during this installation.
2. Connect the cable from a VGA multi-scan monitor to the 15HD connector labeled "MONITOR" on the UNIMUX (See Fig. 3 below.)

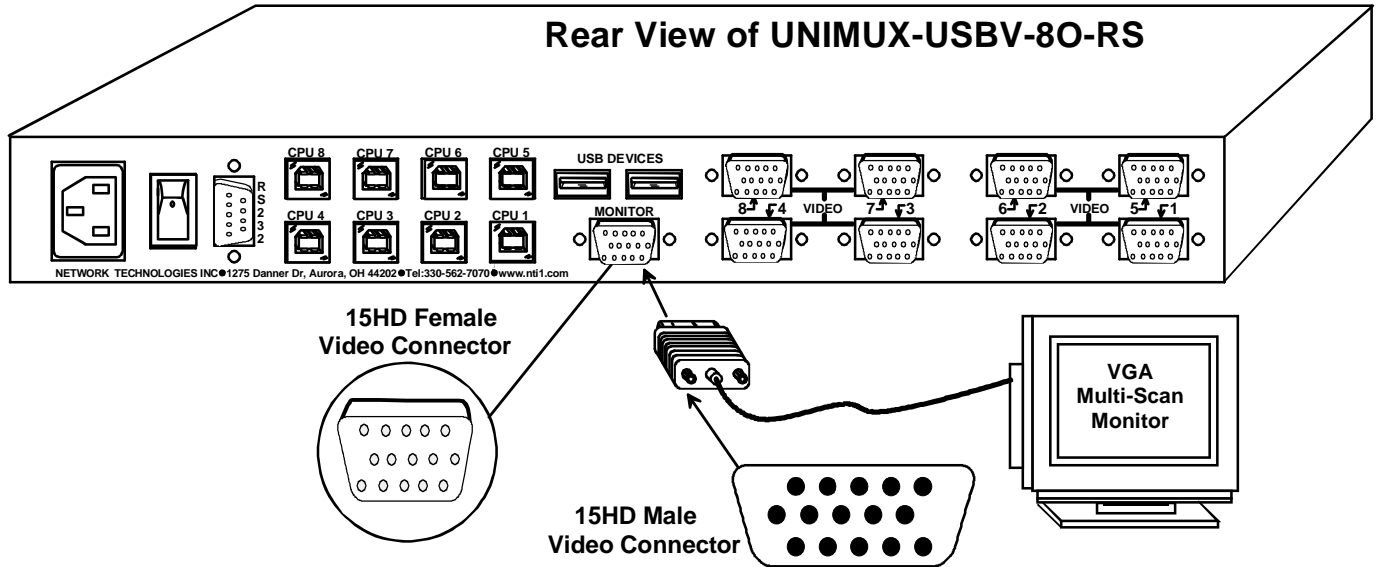

Figure 3- Connect a VGA multi-scan monitor

3. Connect the male USB type A connector on the keyboard cable to either one of the two USB type A female connectors labeled "DEVICES" on the rear panel of the UNIMUX.
4. Connect the male USB type A connector on the mouse cable to the remaining USB type A female connector labeled "DEVICES".

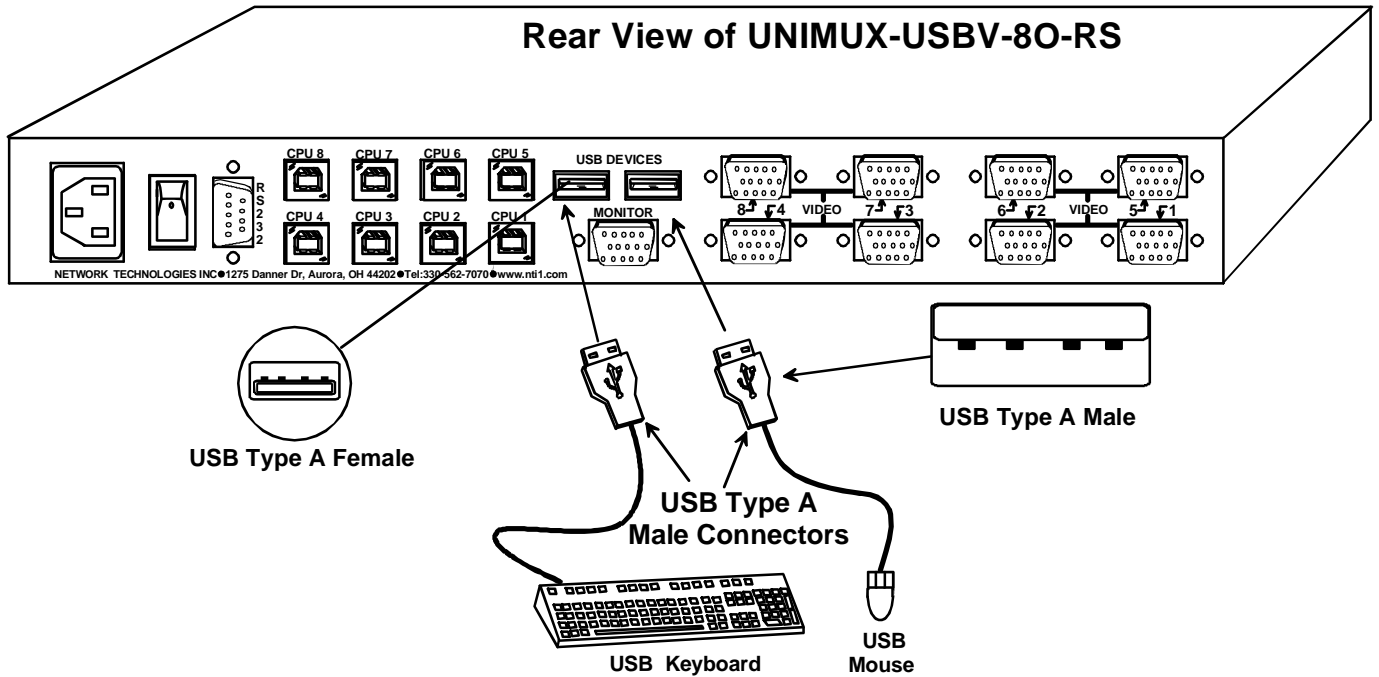

Figure 4- Connect the device(s)

5. When cascading switches, follow the instruction on page 29 for "Cascading".
6. Connect the AC line cord to the UNIMUX. (See Fig. 5 below.)

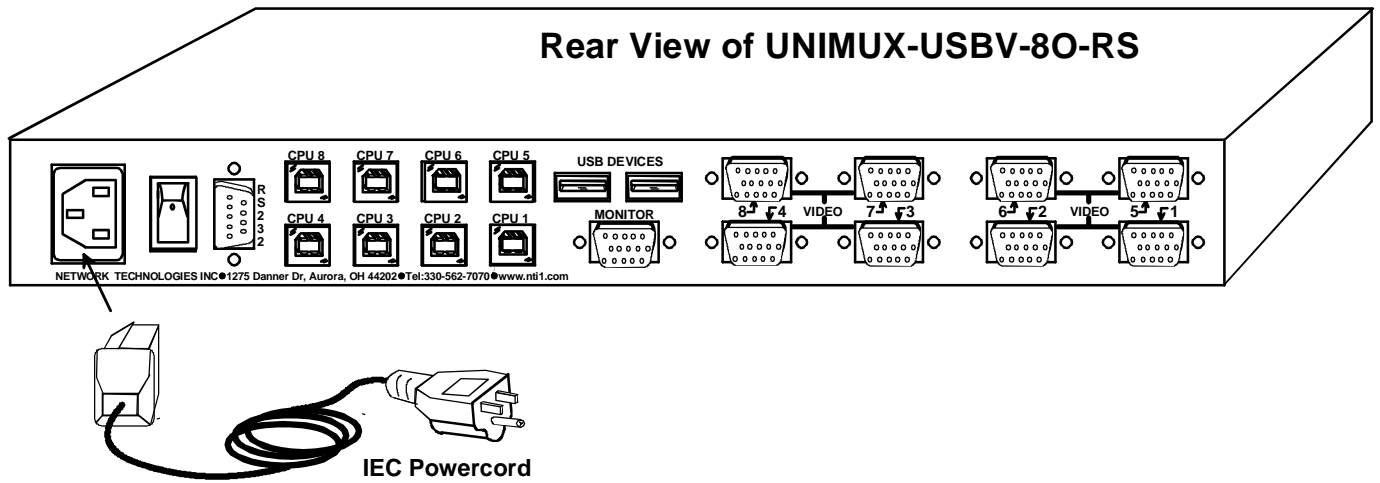

Figure 5- Connect the AC line cord

7. Connect each CPU to the USB switch using a USBVEXT-xx-MM video and input device interface cable – REQUIRED (not supplied). (See Fig. 6 below.)
8. Group the input device and monitor interface cables from each CPU, making sure that cables from the first CPU are connected to the UNIMUX at connectors CPU 1 and VIDEO 1. Cables from the second CPU should connect to CPU 2 and VIDEO 2 connectors...etc.

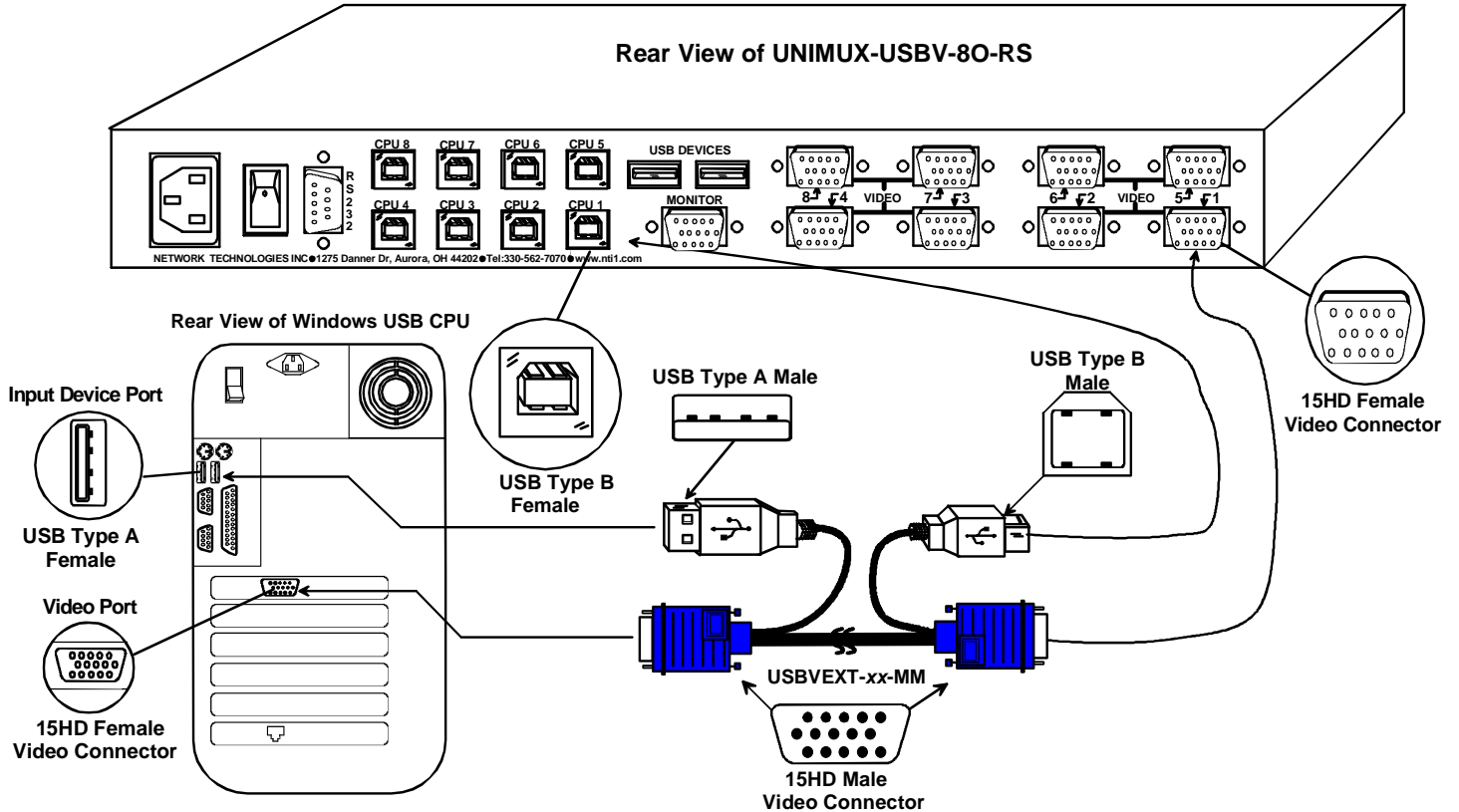

Figure 6- Connect each CPU

Power-Up Sequence

- The UNIMUX can be powered at any time.
- The CPUs can be powered at any time although if a CPU needs a keyboard and/or mouse at power-ON it should be powered after connecting to and powering-ON the UNIMUX.
- USB input devices (keyboard and mouse) can be hot plugged to and from the UNIMUX at any time.

Immediately after powering ON the UNIMUX, the following splash screen will appear on the monitor (except on 2-port model):

If the security option is enabled (see page 12 for details on the "Security Option"), when the UNIMUX is powered up the user will be prompted for a username and password to continue. If the security option is not enabled the monitor will display the desktop image for the connected CPU and the user can continue with normal operation of the connected CPU.

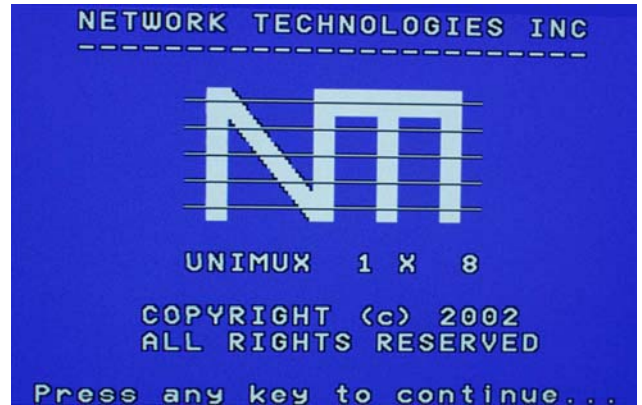

Limitations

- Only USB input device or hub cables can be connected to the UNIMUX at the USB Type A female ports labeled "DEVICES". (See Features and Functions on page 3, item 11.)
- A USB hub (single or multi-port) can be used provided only USB input devices are plugged into it.
- Only a USB Windows or SUN keyboard or USB mouse may be connected to the USB port on a USB MAC keyboard
- A maximum of 8 input devices may be connected to the UNIMUX either directly or through hubs.

See Fig. 7 for some examples of input device combinations that can be used with the UNIMUX.

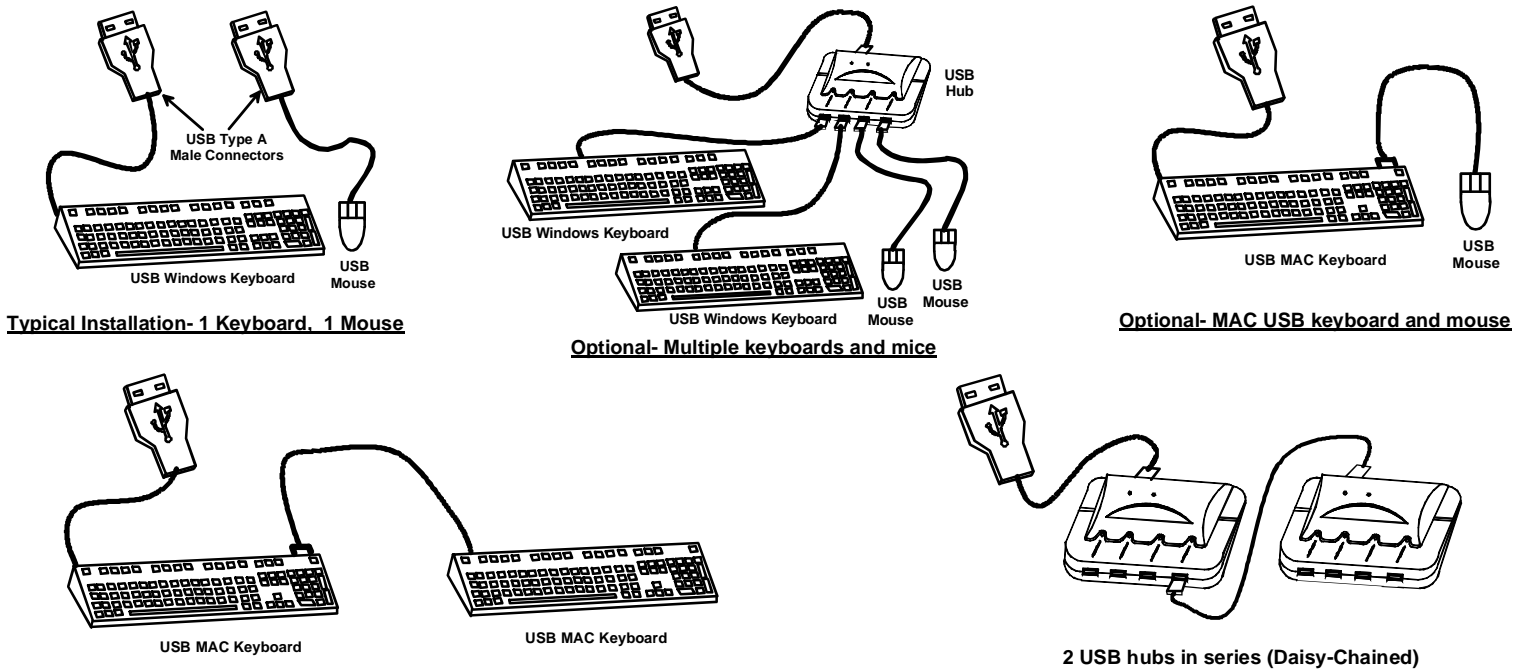

Figure 7- Compatible device combinations

USING THE UNIMUX USB KVM SWITCH

Once the UNIMUX is properly connected, the UNIMUX will enable a connection to be made between the CPUs attached to its VIDEO and CPU ports and the monitor and input devices attached to the MONITOR and DEVICES ports. The LEDs on the control panel of the UNIMUX will illuminate depending on which port (and corresponding CPU) is being connected to the monitor and input devices.

The UNIMUX can be controlled by three methods:

- front control panel using touch-switches and LEDs
- keyboard control through Command Mode
- mouse clicks from within some menus of OSD Command Mode

Front Panel Control

There is a touch-switch and LED on the front panel of the UNIMUX for each CPU the switch will connect the monitor and input devices to. Pressing any touch-switch on the front panel of the UNIMUX will connect the corresponding CPU to the monitor and input devices.

Holding down any front panel touch-switch for more than 2 seconds will cause the UNIMUX to cycle through all modes of operation including COMMAND, BROADCAST, SCAN, and NORMAL (described in "Basic Command Mode" on page 9 and in "User Access Functions" starting on page 18). The three MODE LEDs on the front panel indicate which mode is selected. Release the touch-switch when the LEDs indicate the desired mode. When no mode LEDs are illuminated the user is in Normal Mode controlling directly the CPU to which the user is connected through the UNIMUX.

Keyboard Control

Keyboard control of the UNIMUX can be achieved using either of two methods:

- **Basic Command Mode**- operated strictly by using keyboard commands as instructed below. Basic Command Mode is only applicable in UNIMUX-USBV-2.
- **OSD Command Mode**- operated using the keyboard and mouse in conjunction with OSD menus superimposed onto the monitor. For all models other than UNIMUX-USBV-2, use the menus as instructed on page 12.

By pressing <Ctrl> + <`> (accent key), the user can enter Command Mode (either Basic, or OSD). Once in Command Mode, typing a series of commands will cause the UNIMUX to connect the user to any one CPU connected to the switch. Pressing the <Esc> key will exit Command Mode.

MODES OF OPERATION

Basic Command Mode

In order to control the UNIMUX with the keyboard connected, Command Mode must be enabled. To enter Command Mode from the keyboard:





NOTE: Basic Command mode is only used in a UNIMUX-USBV-2. All other UNIMUX-USBV-x switches have OSD installed. To control these models, proceed to “OSD CONTROL” on page 12. If this is a UNIMUX-USBV-2, continue on this page.

When the COMMAND LED is illuminated, all 3 status lights on the keyboard will illuminate (if they aren't already due to caps lock, scroll lock, and/or num lock) to indicate that Command Mode is enabled and the following functions are available:

Basic Command Functions

KEY SYMBOLS LEGEND:	
OR	PRESS EITHER KEY
+	CHORDED SEQUENCE- PRESS CONSECUTIVELY AND KEEP KEYS PRESSED UNTIL ALL ARE PRESSED.
-	PRESS CONSECUTIVELY





Function: **Keystroke:**

Increment Port  **or**  **or**  (select the next higher port ex. 01 → 02)



Decrement Port  **or**  **or**  (select the next lower port ex. 02 → 01)



Toggle Scan Mode ON and OFF  (The SCAN Mode LED will also toggle ON and OFF)

Toggle Broadcast Mode ON and OFF  (The Broadcast Mode LED will toggle ON and OFF.)

Set scan time-out period for each port.  -  -  -  (xxx from 002 to 255. ie. T002 would set the time-out period for 2 seconds)

Select a specific port  -  -  (P0x would be P01 or P02)

Configure port to connect To a MAC CPU  +  +  (x= 1or 2 <M> + <0> + <1> will enable function on Port 1 <M> + <0> + <2> will enable function on Port 2. Keyboard LED's will flash once to confirm command.)

Configure port to connect To a Windows or SUN CPU  +  +  (x= 1or 2 <W> + <0> + <1> will disable function on Port 1 <W> + <0> + <2> will disable function on Port 2. Keyboard LED's will flash once to confirm command.)

Exit Command Mode 

FYI: The user must exit Command Mode to type to a CPU.

To exit Command Mode, either hold down any touch-switch on the front panel for more than 2 seconds, OR press <ESC> on the keyboard.

Scan Mode

To activate or deactivate Scan Mode press <s> while in Command Mode. When in Scan Mode the switch scans to each port with a CPU powered-ON. (The SCAN LED on the front panel will illuminate and remain ON while in Scan Mode.) The port with the CPU powered-ON remains active while in use until it becomes idle for the configured dwell time (default time-out period is 5 seconds) before switching to the next powered-ON CPU port. See Command Mode section above for configuring the scan dwell time.

Note: The keyboard and mouse must remain idle for the full scan dwell time before the switch selects the next active port.

Broadcast Mode

To activate or deactivate Broadcast Mode press while in Command Mode. Broadcast Mode enables the user to type characters to both computers simultaneously.

NOTE: The user must type somewhat slowly when in Broadcast Mode (less than 20 wpm) and cannot use the <Backspace> key.

Normal Mode

When all of the UNIMUX mode LEDs are OFF the user is in Normal Mode, controlling the CPU to which the user is connected through the UNIMUX.

No SUN Sleep Mode

PLEASE NOTE: It is necessary to configure a SUN CPU (most versions) such that the Sleep Mode is not enabled. If the SUN CPU goes into Sleep Mode either automatically or manually, the user must reboot the SUN CPU in order to resume use of the SUN CPU.

To disable the Sleep Mode, perform the following steps:

1. Select "Power Manager"
2. Look for "Device Idle Time Before Power Saving Starts"
3. Select "Always ON"
4. Look for "Override Device Idle Time For:"
5. Make sure neither "Monitors" nor "Disks" are selected.

Select Country Code

It is possible to configure the UNIMUX to emulate a specific international SUN keyboard regardless of what actual keyboard is connected. This is recommended when the CPU needs the layout code (i.e. a SUN CPU) and the keyboard doesn't have an explicit layout code (i.e. some Windows keyboards). To do this, manually set the UNIMUX to indicate the international keyboard identification number to the CPU using the following procedure;

1. Connect the keyboard to be used to the UNIMUX
2. Enter Command Mode
3. Type Lxx, where xx is the number from the list below that corresponds to the desired country code
4. Exit Command Mode
5. Reboot the CPU connected to the UNIMUX

Country Codes

00	Auto Detect	13	International (ISO)	26	Swedish
01	Arabic	14	Italian	27	Swiss/French
02	Belgian	15	Japan (Katakana)	28	Swiss/German
03	Canadian-Bilingual	16	Korean	29	Switzerland
04	Canadian-French	17	Latin American	30	Taiwan
05	Czech Republic	18	Netherlands/Dutch	31	Turkish
06	Danish	19	Norwegian	32	UK
07	Finnish	20	Persian (Farsi)	33	US
08	French	21	Poland	34	Yugoslavia
09	German	22	Portuguese		
10	Greek	23	Russia		
11	Hebrew	24	Slovakia		
12	Hungary	25	Spanish		

Figure 8- Country Codes for international SUN keyboards

For more on international SUN keyboards, see page 32.

Mice and Trackballs with MACs

The UNIMUX can be configured to enable full functionality between mice and trackballs having two or more buttons and USB MAC CPUs. By default, the ports on the UNIMUX are configured for use with WINDOWS and SUN CPUs and have no special translation for using multi-function mice and trackballs when a MAC CPU is connected. Using the commands <M> + <x> + <x> (xx = port number), or <W> + <x> + <x> in Command Mode (page 8), either enable or disable this feature as needed for each port.

NOTE: Be sure to reconfigure port for connection to a WINDOWS or SUN CPU if a MAC CPU is removed and a WINDOWS or SUN CPU is then connected.

OSD CONTROL

OSD superimposes a menu system on the user's video screen with a list of all connected CPUs. OSD allows CPUs to be named (with up to 12-character names). OSD then allows selection of CPUs by that name. Connected CPUs can be listed by name or by port number. OSD Search Mode enables the user to type in the first few characters of the CPU's name and the OSD will locate it. Help screens assist with all OSD functions.

Security Option

The security option of the OSD Control enables an administrator to control access to CPU ports for each user. Up to 63 users can be created. These users have controlled access to any CPU. Only the administrator can activate or deactivate the security features. Security can be activated from the Maintenance Mode menu (page 24) with a successful administrator login for verification purposes. Furthermore, the administrator can set a maximum idle time value after which the current user will be logged out and the login screen displayed. This time out does not function while the OSD is active. The current security status, idle time out, and scan dwell time are all saved and will be restored whenever power to the switch is cycled OFF, then ON. To reset the administrator's password call NTI and have the device serial number of the UNIMUX available.

Enabling the Security Feature

To enable the security feature the administrator must first enter Command Mode from the keyboard using the sequence <Ctrl> + <'> (accent key). The OSD menu will automatically appear on the monitor in addition to illuminating the Command Mode indicator LED on the UNIMUX. This provides a visual way to control the UNIMUX using the keyboard and mouse.

The administrator, when setting the USB KVM switch up for the first time, may want to proceed directly to the ADMINISTRATION Mode by typing <Ctrl> + <M>, then <A>, and then <Y>.

The factory settings are:

- default user name = root
- default password = nti

In units with earlier manufacturing date:
 default user name = ADMINISTRATOR
 default password= ADMINISTRATOR

Note: The user name for the administrator cannot be changed from "root".

FYI: Capital letters are introduced by keeping the <Shift> key pressed while typing. The <CapsLock> does not work while in OSD.

Once logged-in, follow the instructions on page 15 for setting up users and changing the password. Once the password is setup, if it is lost or forgotten the administrator will have to contact NTI for assistance on clearing the password and set it up again. Within the Administration Mode the administrator can setup each of the users and the limitations of their use of the individual CPUs attached to the switch.



Figure 9- Administrator Login screen

When a standard user powers up the system a security screen will appear if security has been enabled by the administrator. The user will need to login to the switch by following the instructions on page 13 for the USER LOGIN. If the user does not know the appropriate user name and password (setup by the administrator), contact the switch administrator for this information. Once logged-in a user can follow the Command Mode functions described on page 16 to control the switch within the limitations as determined by the administrator.

User Login Mode

User login mode requires a user to login with a user name and password from the list created by the administrator. This mode will also disable use of the front panel until the user logs in.

Function:

Keystroke:

Add a character to the user name/password



(Type any alphabetical or numeric character)

Remove previous character from the user name/password

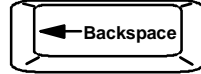

Submit user name/password

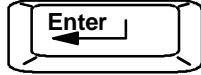

Exit USER LOGIN and return to previous mode. This function is only available if security is not currently active.



Figure 10- User Login screen

If the password submitted is incorrect, the user will not be able to proceed.

If the password submitted is correct, the user will proceed to Normal Mode.

ADDITIONAL MODES AVAILABLE WITH SECURITY

The three modes that follow are only available if the administrator is logged in.

Administration Mode

To enter the Administration Mode menu press <A> from the Maintenance Mode menu (page 24).

Administration Mode allows the administrator to use the following functions:

Function:	Keystroke:
Change the administrator's password	
Disable security	
Update User Name List	
Select the idle time in minutes	- - - (xxx from 000 to 255. i.e. T002 would set the time-out period for 2 minutes. 000 will disable it)
Change Alternate Command Hot Key	(See page 16 for details)
Display Usage Statistics	
Exit Administration Mode and return to previous mode	



Figure 11- Administration Mode menu

Administrator Password

To change the administrator password press <C> from the Administration Mode menu.



The administrator is able to change the administrator password as needed (see Fig. 12). Two edit fields are available, one for password, the other for verify password. The password can be up to 15 characters in length.

Note: The default password for the administrator is "nti". (On earlier units it is "ADMINISTRATOR")

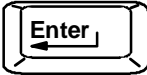
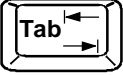

Figure 12- Administrator password change

Function:	Keystroke:
Add character to password string or verify password string	or + (Type any upper or lower case alphabetical or numeric character)
Delete previous character in edited string	

- Save new password.  (If Password string and Verify Password string are different, this command will have no effect, enabling the administrator to correct the password)
- Move to next field to be edited 
- Return to Administration Mode 

User Name List

To enter the User Name List press <U> from the Administration Mode menu.

The User Name List displays the list of users and provides control for adding new users (up to 63), changing or assigning user passwords, and changing access rights for any given user. User names may be up to 12 characters long, may not contain spaces, and are not case sensitive. Passwords may be up to 15 characters long, may not contain spaces, and are case sensitive.







- | | |
|--|---|
| Function: | Keystroke: |
| Select previous user in the list |  |
| Select next user in the list |  |
| Scroll the list with one page up |  |
| Scroll the list with one page down |  |
| Edit selected user settings-
Enter Edit User Mode |  |
| Return to Administration Mode
Return to previous mode |  |



Figure 13- User Name List screen

Edit User

To enter the Edit User mode press <E> from the User Name List after selecting a user or an empty record.

The Edit User mode (see Fig. 14) enables the administrator to:

- add a new user
- remove an existing user
- edit the settings for an existing user

The Edit User mode contains three edit boxes and a check box list of up to 32 check boxes representing the User Access List (list of the CPU port(s) the user has access rights to).









The first edit box is used to edit the user name. The next two edit boxes are used to input the password twice (in order to verify it was typed correctly). The password can be up to 13 characters in length.

The check boxes are used to control the user access to the CPU ports. The user will only have access to check boxes with checks in them.

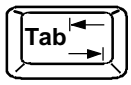

Figure 14- Edit the user access list

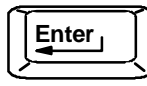
The list below describes the functions available in the Edit User mode:

Function:	Keystroke:
Add a character to user name string, password string, or verify password string, whichever is selected	 OR  +  (Type any upper or lower case alphabetical or numeric character)
Switch sequentially between the User Name edit box, Password edit box, Verify Password edit box, and User Access List	
Navigate through User Access List when it is active	 OR 
Toggle access rights (check/uncheck) of the highlighted port in the User Access List	
Save the edited configuration. Administrator will be prompted for a Yes or No confirmation	 (If Password string and Verify Password string are different, this command will have no effect, enabling the administrator to correct the password)
Go back to User Name List menu	

NOTE: To delete a user from the User Name List, use either the <Delete> key or the <Backspace> key to remove characters, not the <Spacebar>. Using the <Spacebar> will overwrite the characters with spaces and retain the user configuration in the User Name List.

Alternate Command Hot Key

To enable the administrator to assign a key in addition to the <`> (accent key) to use with <Ctrl> to enter into OSD Command Mode, an Alternate Command Hot Key option is provided. The default factory setting for this option is <`> (disabling the option).

To select an Alternate Command Hot Key, press <X> from Administration Mode menu (page 14). A window will open and the administrator will be prompted to press a key. After pressing the key, a confirmation message will appear. The administrator should press <Y> (Yes) to validate the key as the Alternate Command Hot Key, or <N> (No) to select another key. Pressing <Esc> will return to the Administration Mode menu.

Only the administrator is allowed to set or change the Alternate Command Hot Key. This function must be set individually for each of the USB User Device ports on the UNIMUX USBV-x USB KVM switch .

Note: The Alternate Command Hot Key does not replace the <`> (accent) key, it just works as another way to enter into Command Mode. After setting it, the user can enter into Command Mode either with <Ctrl> + <`> or with <Ctrl> + <Alternative Command Hot Key> combination. To disable it, the administrator should set <`> as the Alternate Command Hot Key.

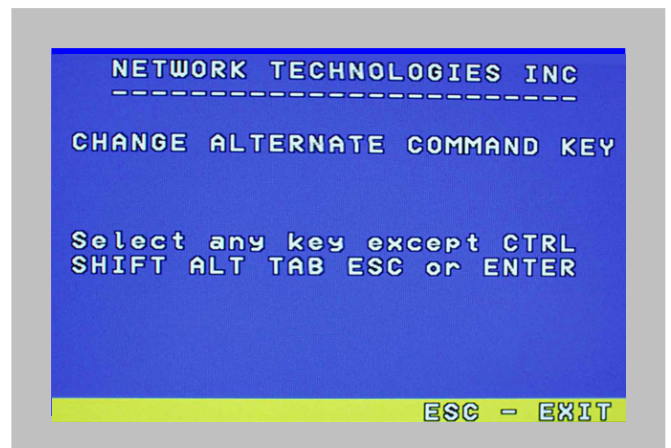

Figure 15- Alternate Command Hot Key

Usage Statistics

To view the Usage Statistics press <D> from the Administration Mode menu.

The Usage Statistic screen has two resettable counters.

- “Power-on cycles” indicates how many times the UNIMUX has been powered-cycled since the counter was last reset. To reset the “Power-on cycles” counter, press the <F1> key.
- “Hours of usage” indicates how many hours of total operation the UNIMUX has had since it was last reset. The hours of usage will continue to be added to regardless of how many times the UNIMUX is power cycled. To reset the “Hours of usage counter” to 0, press the <F2> key.

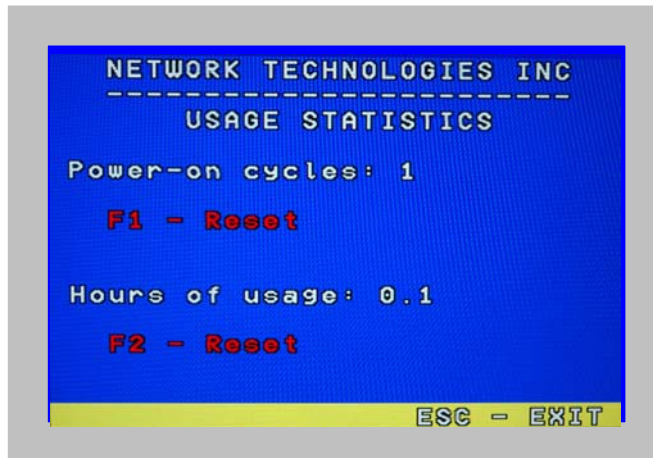

Figure 16- Usage Statistics screen

USER ACCESS FUNCTIONS

Introduction

The OSD menu enables a user to name the CPUs connected to the UNIMUX and connect to them using that name from a single keyboard and mouse. The OSD is positioned on the user's monitor, displaying 8 CPU names at a time. The screen can be used for switching as well as editing the CPUs' names. Through the OSD menu, the user can operate the UNIMUX to have the switch cycle through 3 extended modes of operation: COMMAND, BROADCAST, and SCAN. Three LEDs on the front panel indicate when these modes are enabled.

OSD Command Mode

When entering the Command Mode from the keyboard using the <Ctrl> + <`> (accent key), the OSD menu will automatically appear on the monitor in addition to illuminating the COMMAND indicator LED on the USB KVM switch. This provides a visual way to control the UNIMUX.

The list below describes the OSD Command functions available from the keyboard after entering Command Mode and while the COMMAND LED is illuminated:

Function:

Keystroke:

Select the previous port



Select the next port



Enable/disable Scan Mode

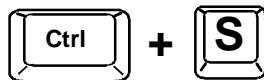

Enable/disable Broadcast Mode

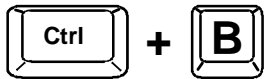

Enter Edit Mode

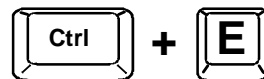

Enter Maintenance Mode

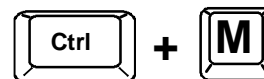

Enter Change Settings Menu

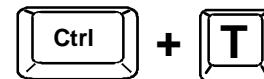

Select a specific port

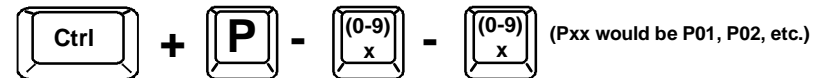

Enter Search Mode and add a character to search string and select the CPU's name that matches best.

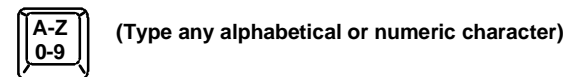

Select the first port on the switch



Select the last port on the switch



Display Help Menu

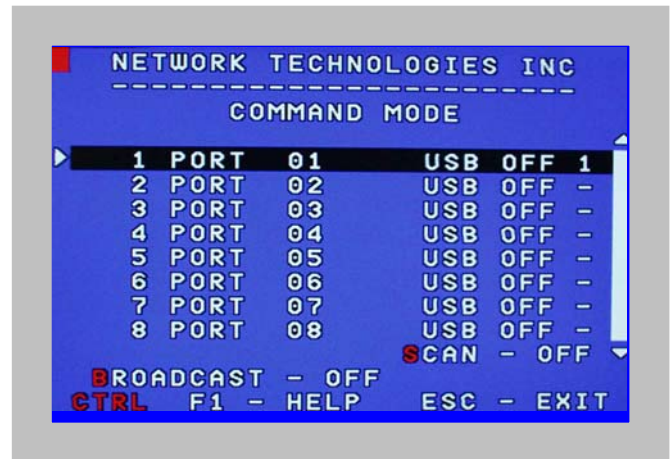

Figure 17- Command Mode screen

NOTE: Edit Mode will only be accessible if the administrator is logged in.

OSD Command Mode (Cont'd)

Function:

Keystroke:

Switch to a selected port

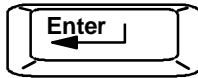

Update Configuration

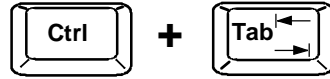

(Use this command to update the information describing the structure of the cascaded switches. Used if a slave is powered-ON or OFF at any time after initial startup.)

Display port information



(Display information about the selected port. When pressed, a window displays the port name and its position in the configuration structure by level and port number.)

Exit OSD Command Mode



Press <CTRL> while in the Command Mode menu to display the Edit, Maintenance, Port, and Settings control features.

Note: The user must exit Command Mode to type to a CPU.

To exit Command Mode, either hold down any touch-switch on the front panel for more than 2 seconds, OR press <ESC> on the keyboard.

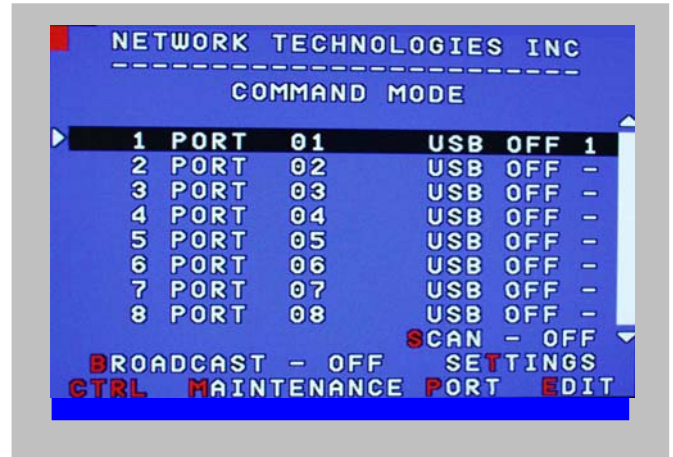

Figure 18- More Command Mode features

The mouse can also be used to control the UNIMUX within the Command Mode menu.

- The mouse cursor can be moved to the Scan, Help, Broadcast, Settings, Maintenance, and Exit fields where the user can then click on the left mouse button to perform that function.
- Ports listed on the screen can be selected by moving the cursor onto that port and clicking. Clicking twice on a selected port will switch to that port and exit Command Mode.
- To change the displayed ports on the screen simply click on the up and down arrows located to the right of the port names displayed.

Broadcast Mode

To activate or deactivate Broadcast Mode press <Ctrl> + from the Command Mode menu.

Broadcast Mode enables the user to type characters to more computers simultaneously. From the Change Settings menu (see page 19) the user can edit the list of ports that receive data in Broadcast Mode. A port doesn't receive broadcast data if one of the following conditions is true:

- the port is not in the Broadcast Mode list
- Security Mode is enabled and the user does not have access rights to the port

Note: The user must type somewhat slowly when in Broadcast Mode (less than 20 wpm) and cannot use the <Backspace> key.

Scan Mode

To activate or deactivate Scan Mode press <Ctrl> + <S> from the Command Mode menu.

When in Scan Mode the switch scans to each port with a CPU powered-ON. (The SCAN LED on the front panel will illuminate and remain ON while in Scan Mode.) The port with the CPU powered-ON remains active while in use until it becomes idle for the configured dwell time (default time-out period is 5 seconds) before switching to the next powered-ON CPU port. See Command Mode section above for configuring the scan dwell time.

Note: The keyboard and mouse must remain idle for the full scan dwell time before the switch selects the next active port.

Note: The scan dwell time set by the user only affects that user and has no effect on other switch users.

Normal Mode

When the UNIMUX is not in Command, Broadcast, or Scan mode and all of the UNIMUX mode LEDs are OFF, the user is in Normal Mode, controlling the CPU to which the user is connected through the USB KVM switch.

Edit Mode

Note: Edit Mode will only be accessible if the administrator is logged in.

To activate Edit Mode press <Ctrl> + <E> from the Command Mode menu.

Edit Mode enables the administrator to modify the names of the CPUs connected to the switch. Names of CPUs can be up to 12 characters in length. Use the <Shift> key to introduce capital letters (the <CapsLock> does not work in OSD).

Function:

Keystroke:

Move cursor one position to the right



Move cursor one position to the left



Move cursor to the previous port



Move cursor to the next port



Selects the first port on the switch



Selects the last port on the switch



Toggles between insert and overstrike



(The character either gets inserted and the remainder of the name gets shifted to the right, OR the current character gets overwritten.)

Erase current character



Erase previous character

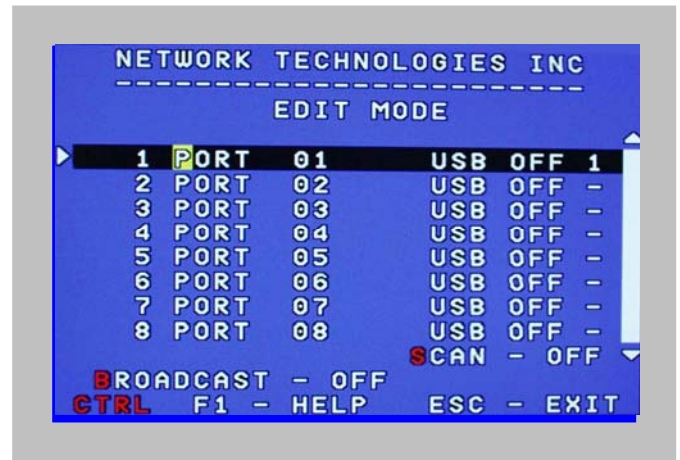
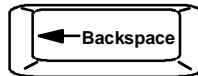









Figure 19- Edit Mode screen

When finished making changes in Edit Mode, press <Enter> and a prompt will appear to press either <Y> to save the changes or <N> to continue making changes without saving the changes just made. If the <Esc> key is pressed instead of <Enter>, all changes made will be ignored and the display will return to the previous menu.

Change Settings

To enter the Change Settings menu (see Fig. 20) press <Ctrl>+<T> from the Command Mode menu.

The list below describes the Change Settings menu functions available from the keyboard:

Function:	Keystroke:
Go to Broadcast Mode Configuration	
Go to Scan Mode Configuration	
Go to Language Selection Menu (Option only available if the administrator is logged in)	
Change the scan dwell time period	
Configure ports for MAC or non-MAC CPUs (Administrator only)	
Enable/Disable right mouse button click emulation	
Exit from Change Settings Return to Command Mode	

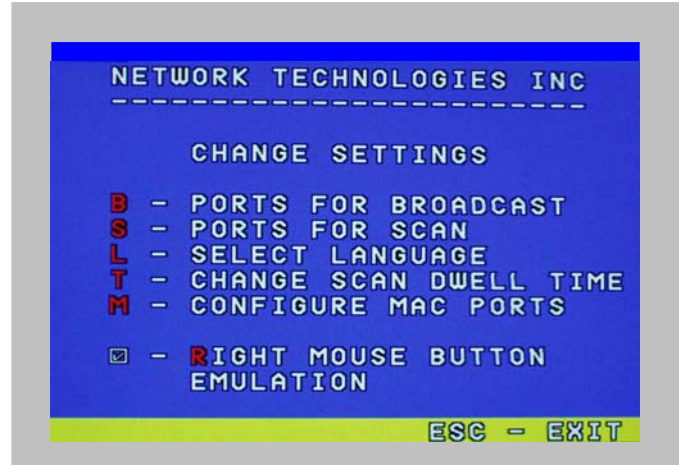

Figure 20- Change Settings menu

When the <T> is pressed, an edit field showing the actual value of the scan dwell time is displayed at the bottom of the Change Settings menu. The user can introduce a new value for scan dwell time and press <Enter> to save it or <Esc> to exit. Any value between 002 and 255 (seconds) is acceptable.

Select Ports For Broadcast

To Select Ports For Broadcasting, press from the Change Settings menu (see Fig. 20).

The Select Ports For Broadcast menu (see Fig. 21) enables the user to select specific ports to be active in Broadcast Mode. Only the selected ports will receive keyboard messages in Broadcast Mode.

A checklist with all the port numbers will be displayed in the window.

- unchecked box = the corresponding port is **not** in the broadcast list
- checked box = the corresponding port **is** in the broadcast list

The user can toggle the state of the selected check box by pressing <Spacebar> or clicking the left mouse button.

- press <S> to check all of the ports
- press <C> to uncheck all of the ports

The selected port is highlighted with a green bar. To select another port, the user can use the arrow keys or mouse movement. The name of the selected port is displayed at the bottom left of the menu.

When <Esc> is pressed the display will return to the Change Settings menu. The broadcast selection list is automatically saved.

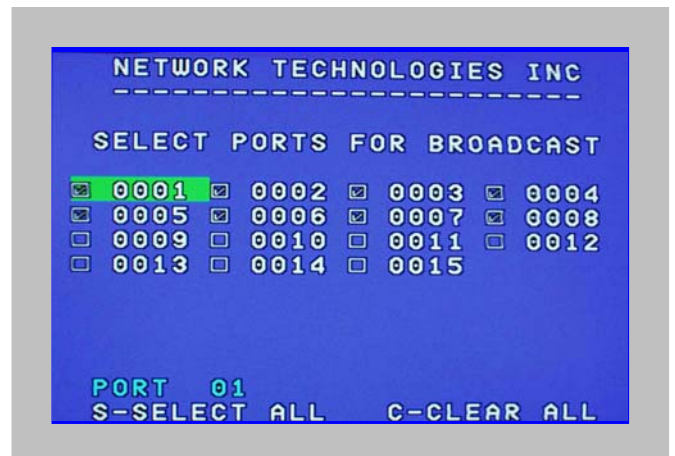

Figure 21- Select ports for broadcasting

Select Ports For Scan

To Select Ports For Scanning, press <S> from the Change Settings menu described on page 21.

The Select Ports For Scan menu enables the user to select specific ports to be active in Scan Mode. Only the selected ports will be scanned in Scan Mode.

A checklist with all the port numbers preceded by a check box will be displayed in the window.

- unchecked box = the corresponding port is **not** in the scan list
- checked box = the corresponding port **is** in the scan list

The user can toggle the state of the selected check box by pressing <Spacebar> or clicking the left mouse button.

- press <S> to check all of the ports
- press <C> to uncheck all of the ports



Figure 22- Select ports for scanning

The selected port is highlighted with a green bar. To select another port, the user can use the arrow keys or mouse movement. The name of the selected port is displayed at the bottom left of the menu.

When <Esc> is pressed the display will return to the Change Settings menu. The scan selection list is automatically saved.

Language Selection

Note: The LANGUAGE SELECTION option will only be accessible if the administrator is logged in.

To enter the Select Language menu press <L> from the Change Settings menu described on page 21.

The Language Selection menu enables the user to manually configure the UNIMUX to emulate a specific international SUN keyboard regardless of what actual keyboard is connected. This is recommended when the CPU needs the layout code (i.e. a SUN CPU) and the keyboard doesn't have an explicit layout code (i.e. Windows keyboards).

To choose a language, scroll through the menu (using either the mouse or up/down arrows) and when the desired language is highlighted press <Enter> on the main keyboard. The selected language will be highlighted in red. Press <Esc> to return to the Change Settings menu.



Figure 23- Select the keyboard language

For more on International SUN keyboards, see page 32.

MAC Ports Configuration

Note: The CONFIGURE MAC PORTS option will only be accessible if the administrator is logged in.

MAC Ports Configuration menu enables the administrator to select specific ports to be connected to MAC CPUs for passing mouse information to the MAC CPUs. This is useful when the user wants to use mouse drivers provided by the mouse vendor, which allows the use of programmable functions for each button. Ports should be configured at installation time or whenever necessary. After setting, the configuration is stored in non-volatile memory and will be retrieved whenever the switch is powered-ON. When the port is connected to a Windows or SUN CPU, this configuration SHOULD BE DISABLED. By default, all ports are configured as non-MAC CPUs (Windows and SUN).

Note: If a port is configured as connected to a non-MAC CPU, but is in fact connected to a MAC CPU, the mouse will still work as a generic mouse. No special functions provided by software drivers will be available.

To enter the MAC Ports Configuration menu, the administrator must press <M> from the Change Settings menu, described on page 21.

A checklist with all the ports numbers preceded by a check box will be displayed in the window.

- unchecked box = the corresponding port is set as connected to a non-MAC CPU
- checked box = the corresponding port is set as connected to a MAC CPU

In order to change the status of a port, the administrator has to first select the port. The selected port is highlighted with a green bar.

To select another port, the administrator can use the arrow keys or mouse movement. The name of the selected port is displayed at the bottom left of the menu.

The administrator can toggle the state of the selected check box by pressing the <Spacebar> or clicking the left mouse button.

- Press <S> to check all the ports
- Press <C> to uncheck all the ports

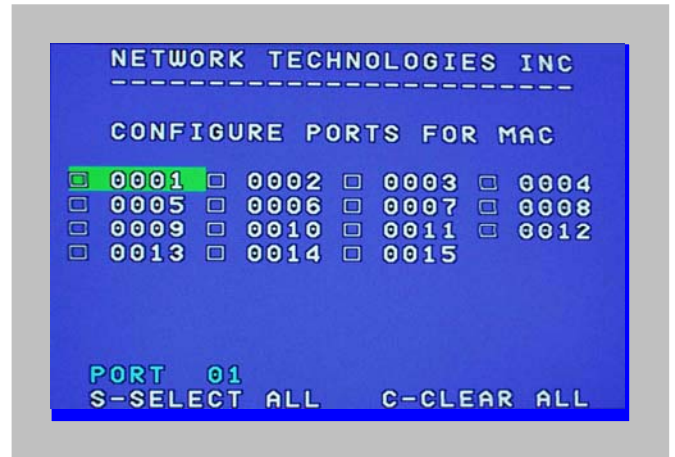

Figure 24- Configure Ports for MAC screen

When <Esc> is pressed, the display will return to the Change Settings menu. The list is automatically saved.

The settings apply to all users of the switch.

Search Mode

To enter Search Mode, type any alphabetical or numeric character when the Command Mode menu is on the monitor.

Search Mode enables the user to enter and maneuver through a list of CPU names. The CPU name best matching the characters typed is selected. The list of CPUs may also be searched for a specific (or similar) name. The following commands are valid when the search option has been invoked from Command Mode.

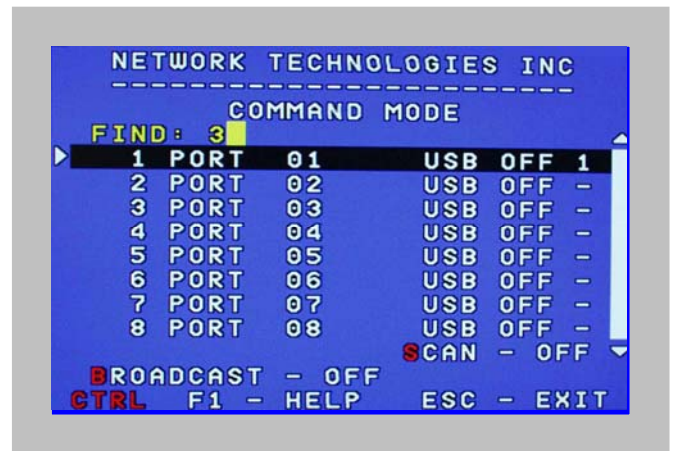
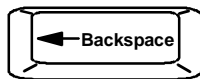

Figure 25- Search Mode screen

Function:

Keystroke:

Erase previous character in search name



Add a character to the search string and select the best matching CPU name



(Type any alphabetical or numeric character)

Exit Search Mode, return to Command Mode



Switch to selected port



Maintenance Mode

To enter Maintenance Mode press <Ctrl>+<M> from the Command Mode menu.

Maintenance Mode enables a user to customize the On Screen Display to their requirements.

Function:

Keystroke:

Reset all of the port names



Toggle between numeric and alphabetic listing of ports



Move On Screen Display (OSD) menu up on monitor



Move OSD menu down on monitor



Move OSD menu to the right



Move OSD menu to the left



Make OSD menu taller



Make OSD menu shorter



Change user password.
(Present only when a standard user is logged in.)



Log current user out and return to User Login Mode.



Activate security features.

Present only when security is available but not active.



Enter Administration Mode.

Option present only when Administrator is logged in.

Save OSD window parameters for the port

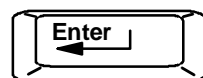

Return to Command Mode





Figure 26- Maintenance Mode screen

FYI: If activating security features, the user will be prompted for a "Y" (yes) or "N" (no) to confirm the menu choice, at which point the user will be asked for a username and password before continuing. Only the administrator can activate the security features.

Help Mode

To enter Help Mode press the <F1> key from the Command Mode menu (on page 17).

Help Mode displays a list of commands with a short explanation of their function. These lists are organized in pages for each mode (i.e. COMMAND, EDIT, and SEARCH). The following options enable the user to quickly obtain information on any command.

Function:	Keystroke:
View the previous page of help if available	
View the next page of help if available	
Exit HELP and return to previous mode	

F3- Display Information

To display information about a selected port, pressing the <F3> key from within the Command Mode main menu will cause a window to open. The window will show the name of the port and its position in the system structure, level by level. This is most useful when cascading switches (for Cascading see page 33). An example of this structure might be

LEVEL 1 : PORT 5
LEVEL 2 : PORT 3

This means that the CPU connected through this port is actually connected through Port 5 of the master switch (Level 1), and through port 3 of the slave connected to port 5 (Level 2). See Figure 27 below.

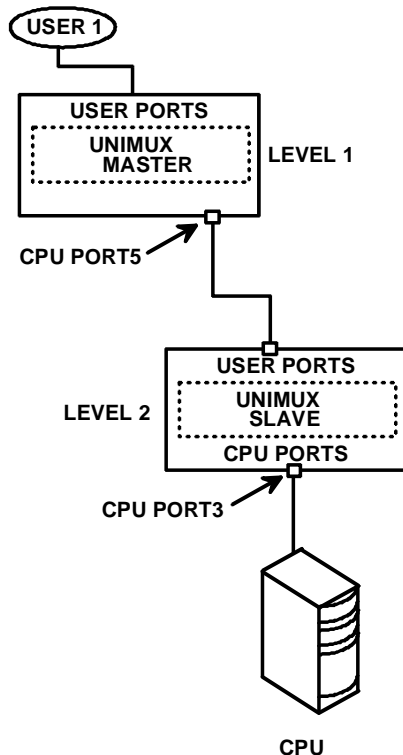

Figure 27- Information provided by the F3 command

RS232 CONTROL

(Optional)

RS232 enables the UNIMUX to be remotely controlled via RS232. To control the UNIMUX via RS232 the user has three options:

- write a program that runs on a PC using the Command Protocol (page 27)
- use the NTI Switch Control Program (page 29)
- use the SerTest program (page 29)

RS232 Connections and Configuration

Remote Connection

The RS232 Interface (optional) is designed to meet the RS232C standard and can be controlled from any CPU or other controller with an RS232 communications port. The pin-out for the DB9 connector(s) on the unit is as follows:

RS232 CONNECTOR (DB9 FEMALE)

PIN	SIGNAL	FUNCTION
1	CD	Carrier Detect
2	TXD	Transmit data (RXD at host)
3	RXD	Receive data (TXD at host)
4	DTR	Data terminal ready
5	GND	Signal ground
6	DSR	Data set ready
7	RTS	Request to send
8	CTS	Clear to send
9	-	No connection

Note: Security must be disabled or user access granted on the port(s) to be selected by RS232 control.

On the DB9 female connector, pins 1 (DCD), 4 (DTR), and 6 (DSR) are shorted and pins 7 (RTS) and 8 (CTS) are shorted. Therefore, host handshaking is bypassed and TXD and RXD are the only active signals. A straight through DB9 cable (not null modem) will work for most CPUs (see page 38 for cable pinout) . To daisy chain multiple units, a Matrix Y-1 cable is used (see page 27) for each UNIMUX in the chain. The last unit will have no connection on its output port and should have DIP switch 1 ON (see table under "Unit Address and Loop Back" on page 27).

Baud Rate

The baud rate can be changed by powering down the unit, changing the 8 position RS232 DIP switch on the front of the UNIMUX, and then powering back up. This table shows how to set the baud rate.

DIP SWITCH			BAUD RATE
4	3	2	
OFF	OFF	OFF	300
OFF	OFF	ON	600
OFF	ON	OFF	1200
OFF	ON	ON	2400
ON	OFF	OFF	4800
ON	OFF	ON	9600
ON	ON	OFF	
ON	ON	ON	

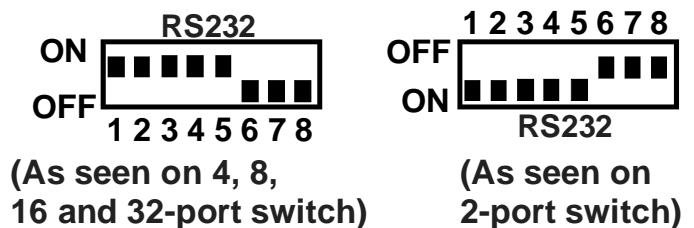

Figure 28- RS232 DIP switches

Unit Address and Loop Back

To allow multiple units to be controlled from a single CPU serial port, the RS232 control interface is designed to allow "daisy chaining" up to 15 units. By setting the appropriate RS232 DIP switches, each unit can be given a unique address (1-15). Then the unit will only respond to commands on the bus if its address is embedded in the command. Use the table below to set the unit address.

DIP SWITCH				UNIT ADDRESS
8	7	6	5	
OFF	OFF	OFF	OFF	0 (not valid)
OFF	OFF	OFF	ON	1
OFF	OFF	ON	OFF	2
OFF	OFF	ON	ON	3
OFF	ON	OFF	OFF	4
OFF	ON	OFF	ON	5
OFF	ON	ON	OFF	6
OFF	ON	ON	ON	7
ON	OFF	OFF	OFF	8
ON	OFF	OFF	ON	9
ON	OFF	ON	OFF	10
ON	OFF	ON	ON	11
ON	ON	OFF	OFF	12
ON	ON	OFF	ON	13
ON	ON	ON	OFF	14
ON	ON	ON	ON	15

Note: The "loop back" RS232 DIP switch (RS232 DIP switch 1) should be ON for the last unit in the chain, and OFF for all other units. If only one unit is being controlled, the loop back DIP switch should be left ON.

Note: In order to connect multiple UNIMUX units together a Matrix-Y-1 cable must be used. (See Fig. 29.) See Fig. 30 for the pinout of the Matrix-Y-1 cable.

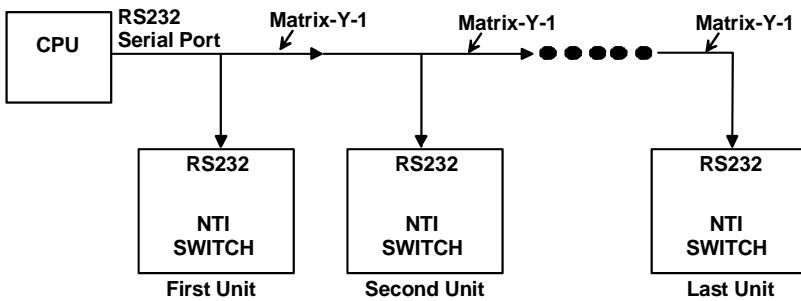

Figure 29- RS232 connection with Matrix-Y-1 cable

Wiring Schematic of Matrix-Y-1 cable

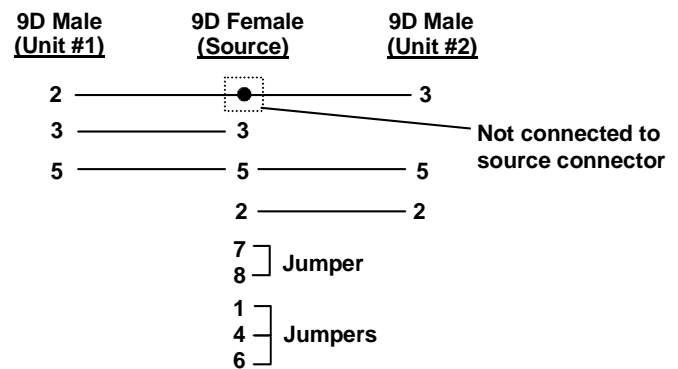

Figure 30- Pinout of Matrix-Y-1 cable

Command Protocol

RS232 commands supported by the unit are defined below. All command strings should be terminated with a <CR> (carriage return). When a command is sent, the entire string is echoed back along with a response from the addressed unit as shown in the command definitions. All characters in the command string should be upper case, and all numbers below 10 should have a leading 0 (ex: 1 = 01). As command strings are sent, the inner character delay cannot exceed 500 milliseconds.

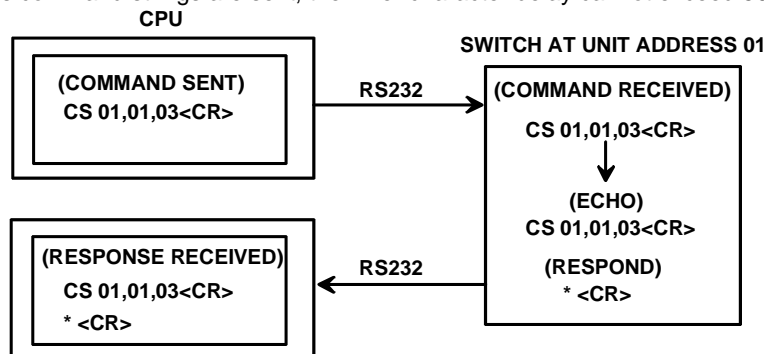

Figure 31- RS232 Communication Illustrated

Note: To use this command protocol, the user is required to write a program that will send an entire command string all at once, not character by character. Programs that send one character at a time (such as HyperTerminal) cannot be used to control the UNIMUX. Alternatively, the user may use the NTI Switch Control Program or SerTest to control the UNIMUX via RS232 (see page 27).

Legend: (All numbers must be two digits)

SW : Switch (01-15) (Unit Address)
 OP : Output (User) Port (01)
 IP : Input (CPU) Port (01-MAXINPUTS)
 <CR> : Carriage Return (Hex 0xD)

Note: For units with one output (user) port, use 01 for the output selection.

Command Definitions

Command String	Good Response	Description
CS SW,IP,OP	*<CR>	Connect Output (User) Port To specific Input (CPU) Port
RO SW,OP	*<CR>IP<CR>	Read Connection For Output (User) Port to Input (CPU) Port
RS SW	*<CR>	Internal Reset
RU SW	*<CR>IP,OP<CR>	Read Unit Size
SS SW,00	*<CR>	Disable Autostatus feature (see below)
SS SW,01	*<CR>	Enable Autostatus feature (see below)
GO SW,OP	*<CR>go SW,OP:IP<CR>	Read connection of an Output (User) Port to Input (CPU) Port (different response format than RO command)
GM SW,00	*<CR>go OP,IP (all ports)<CR>	Read connection matrix of all Output (User) ports

If the first field is not a known command (as listed above) or SW field is different from the unit address programmed at the DIP switch (page 25), the command will be ignored. If the SW field corresponds to the unit address, but if the syntax is wrong after this field, the switch will answer with a bad response ?<CR>.

Syntax example:

cs 01,05,01<CR> (insert the space and commas as shown)
 which means "At the switch with unit address 01, connect CPU port 05 to user port 01"
 The switch will answer with:

*<CR>

The HEX code representation of example above is:

Byte 1	Byte 2	Byte 3	Byte 4	Byte 5	Byte 6	Byte 7	Byte 8	Byte 9
'C' (0x43)	'S' (0x53)	Space (0x20)	Switch – 1st digit (0x30)	Switch – 2nd digit (0x31)	',' (0x2C)	Output – 1st digit (0x30)	Output – 2nd digit (0x35)	',' (0x2C)

Byte 10	Byte 11	Byte 12
Input – 1st digit (0x30)	Input – 2nd digit (0x31)	<CR> (0x0D)

Response:

Byte 1	Byte 2
'*' (0x2A)	<CR> (0x0D)

Autostatus

When Autostatus is enabled, any output (user) -to-input (CPU) connection change in the UNIMUX will cause an Autostatus message to be sent via RS232 to the administrator. The format of the message would be "pc SW,OP:IP<CR>"

Example of an Autostatus message:

pc 01,01:04<CR>

which means "At the switch with unit address 01, the output (User) (01) has changed connection to input (CPU) port 04."

Note: An Autostatus message to the administrator will be delayed by any RS232 traffic being received by the switch from the administrator.

By default, Autostatus is disabled and must be manually enabled.

NTI Switch Control Program For Windows 9X, NT, 2000, XP, Vista,7, 8 and 10

The NTI Switch Control Program is an easy and powerful graphical program that controls NTI switches through an RS232 interface. The NTI Switch Control Program can be downloaded from <http://www.networktechinc.com/srvsw-usbu.html#tab-6>

To install the NTI Switch Control Program after downloading

1. Locate the **Setup.exe** in the directory the program was downloaded to and double-click on it
2. Follow the instructions on the screen

Note: In order to use the NTI Switch Control Program to control the UNIMUX, the UNIMUX RS232 port must be set at a baud rate of 9600 bps (see page 26).

The NTI Switch Control Program performs best on monitors set to a screen resolution of at least 800 X 600. Instruction for using the NTI Switch Control Program is available by opening "MSCP Help" in the "NTI" program group once the program has been installed and is open on the screen.

To open "MSCP Help" from the Windows desktop

1. Click on **START**
2. Click on **PROGRAMS**
3. Click on **NTI**
4. Click on **MSCP Help**

SerTest- RS232 Interface Test Program

This software allows a user to test the functions of an NTI server switch, matrix switch or Multi-user/Multi-platform/Single-user switch RS232 interface. The SerTest program is automatically loaded when installing the NTI Switch Control Program as described above. The SerTest program, located in the NTI program group, generates a main menu with the 4 selections described below:

Main Options

- Switch Operations - send commands to the unit.
- Ethernet Operations - set Ethernet connection variables (not applicable to this model)
- Setup Options - set COM port, baud rate, and unit address
- About SerTest - display the program version

If Matrix Operations is selected, the following menu is displayed:

SWITCH OPERATIONS

- 1) Reset Unit
 - send a reset command to the switch
 - the current unit address is displayed in parentheses
- 2) Reset All Units
 - send an internal reset command to all switches
- 3) Connect Output/User to an Input/CPU
 - connect an output to an input
- 4) Connect All Outputs/Users to an Input/CPU (not applicable to this model)
 - connect all outputs to an input
- 5) Connect Audio Output/User to an Input/CPU (not applicable to this model)
 - connect an output to an input
- 6) Connect All Audio Outputs/Users to an Input/CPU (not applicable to this model)
 - connect all outputs to an input
- 7) Change Mute Status for Audio Output/User (not applicable to this model)
 - mute or un-mute the Audio port output
- 8) Change Volume for Audio Output/User (not applicable to this model)
 - change Audio port output volume

- 9) Read Connection for Output/User
 - read what input is connected to the specified output
- a) Read Connection for Audio Output/User (not applicable to this model)
 - read what input is connected to the specified output
- b) Read Mute Status and Volume for Audio Output/User (not applicable to this model)
 - read the volume and the mute status of the specified output
- c) Read Unit Size
 - read the switch size (number of inputs and outputs)
- d) Read Unit Version/Revision String (not supported by this model)
 - read a string containing the switch version, type, and size
- e) Save I/O Connections into Unit Memory (not applicable to this model)
 - save the connections into switch memory bank
- f) Restore I/O Connections from Unit Memory (not applicable to this model)
 - restore the connections from switch memory bank
- g) Save All Units I/O Connections into Units Memory (not applicable to this model)
 - save the connections into switch memory bank, command for all switches
- h) Restore All Units I/O Connections from Units Memory (not applicable to this model)
 - restore the connections from switch memory bank, command for all switches
- i) Change All Units Baud Rate (9600/COM1) (not applicable to this model)
 - change RS-232 Baud rate of all switches
 - the current baud rate and serial port are displayed in parentheses

ETHERNET OPERATIONS (not applicable to this model)

SETUP OPTIONS

- 1) Select Com port current: (COM1:)
 - select PC serial port
 - the current PC serial port is displayed in parentheses
- 2) Select Baud rate current: (9600)
 - select PC serial port baud rate
 - the current baud rate is displayed in parentheses
- 3) Set unit Address current: (1)
 - select the unit address of the switch to be connected to by this program
 - the current address is displayed in parentheses

For any selection that requires user input, the user is prompted. When commands are sent to the UNIMUX, the command string and UNIMUX responses are echoed to the screen. All commands generated by the program are formatted according to the information provided in sections above. If any transmission problems are detected, an error message is displayed.

Press <Esc> or <Enter> to back out to the main menu and press again to exit.

MOUSE CLICK EQUIVALENTS

To emulate a right button click using Apple 1 button mouse, hold down the Command key () while pressing the mouse button.

Note: Right mouse button emulation must be enabled (see Change Settings on page 19) for this to work.

KEYBOARD FEATURES

The keyboard configuration of each CPU is saved in the UNIMUX. For example, if the CPU attached to Port 2 had CAPS LOCK and NUM LOCK selected the last time that CPU was accessed, then they will automatically be set when that CPU is accessed again.

Keyboard-To-Computer Translation (See Fig. 32 on page 32 for reference.)

The UNIMUX enables a mixture of otherwise incompatible peripheral computer components to be connected together. This is accomplished by performing keyboard-to-computer translations automatically (i.e. translate a MAC keyboard and mouse to a Windows type CPU). The chart below shows the capabilities of devices controlling certain CPU types.

Translation Capabilities

Device	CPU		
	Sun	Mac	Windows
Sun Keyboard	Full functionality	Full functionality	Full functionality
AT101 Keyboard	Extra keys emulation	Power key emulation	Full functionality
Mac keyboard	Extra keys emulation	Full functionality	Full functionality-except Application Key
Apple Pro Keyboard	Extra keys emulation	Extra Keys not supported (Eject, Mute, Volume+, Volume-)	Full functionality
Sun Mouse	Full functionality	Full functionality	Full functionality
Wheel Mouse	Full functionality	Full functionality	Full functionality
Apple Mouse	Right button emulation	Full functionality	Right button emulation

Translation Tables

Use the charts below to type SUN's additional keys with Win95 and Apple keyboards:

SUN Extra Keys

WINxx or Mac Keyboards	Sun Extra Keys
Space Bar + F1	Stop
Space Bar + F2	Again
Space Bar + F3	Props
Space Bar + F4	Undo
Space Bar + F5	Front
Space Bar + F6	Copy
Space Bar + F7	Open
Space Bar + F8	Paste
Space Bar + F9	Find
Space Bar + F10	Cut
Space Bar + F11	Help
Space Bar + F12	Compose
Space Bar + Up Arrow	Volume +
Space Bar + Down Arrow	Volume -
Space Bar + Left Arrow	Mute

Power Key Emulation

Win95 Keyboards	Mac CPU	Sun CPU
SB+RT Arrow	Power	Power

Mouse Click Equivalents

To emulate right-button click using an Apple 1-button mouse, hold down the CMND key (key with open apple insignia) while pressing the mouse button.

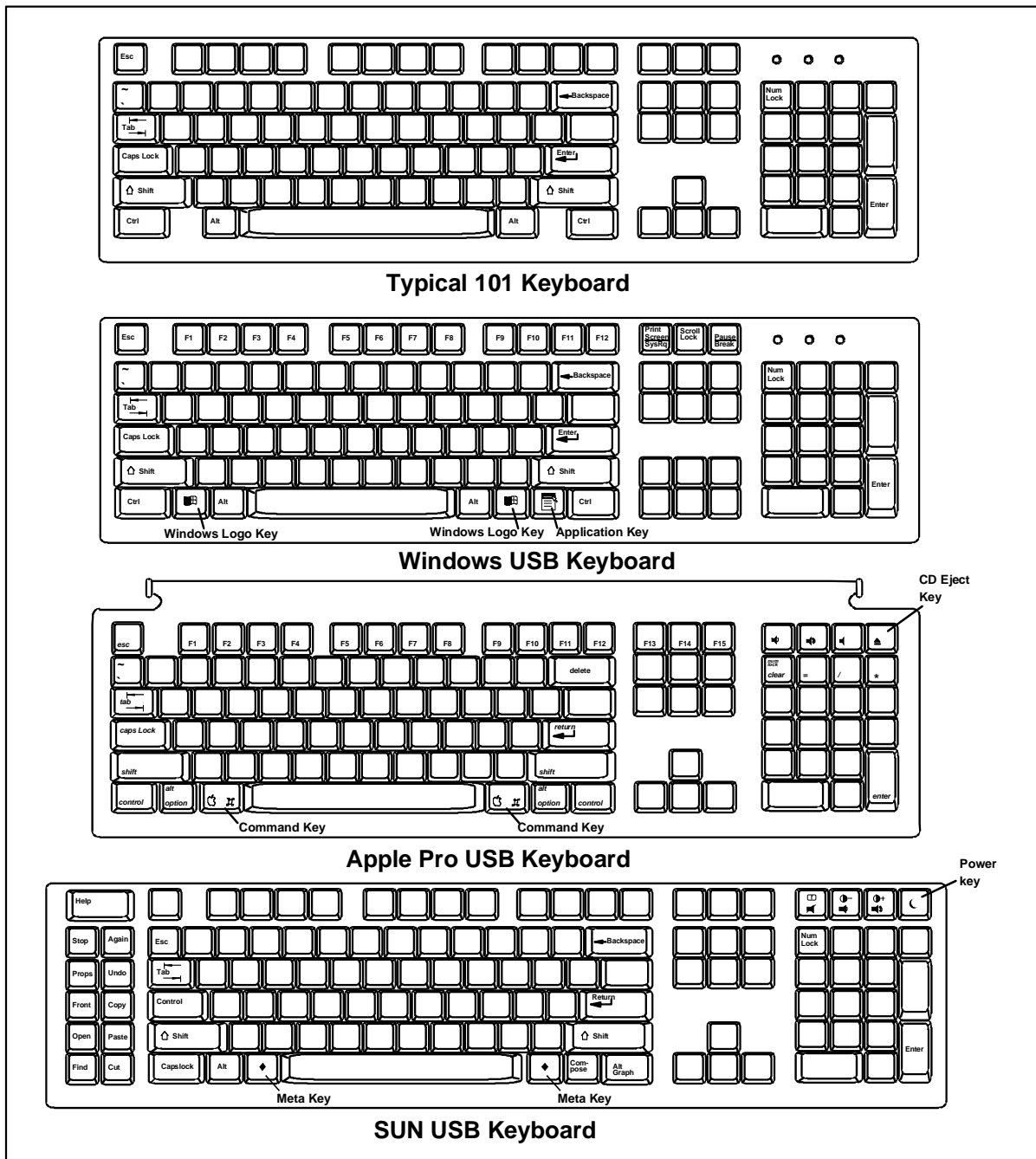

Figure 32- Keyboard Layouts

International Sun Keyboards

The UNIMUX can recognize international layouts for Sun keyboards. In order to use an international Sun keyboard, follow this procedure:

1. Power-OFF the CPU from the UNIMUX
2. Connect the international keyboard to be used to the UNIMUX
3. Power-ON the CPU to the UNIMUX

It is also possible to configure the UNIMUX to emulate a specific international Sun keyboard regardless of what actual keyboard is connected. This is recommended when the CPU needs the layout code (i.e. a SUN CPU) and the keyboard doesn't have an explicit layout code (i.e. some Windows keyboards). To do this, manually set the UNIMUX to indicate the international keyboard identification number to the CPU by following the instruction on page 9 (for switches without OSD feature) or on page 19 (for switches with OSD feature).

CASCADING

The UNIMUX-USBV-x USB KVM switch can be cascaded as shown in Fig. 33 below. Single user and multi-user UNIMUX switches may be connected downstream (see Figs.35 and 36). The first switch in a cascaded system is referred to as the "master", while all downstream switches are referred to as "slaves". The only additional hardware required to cascade switches is a set of device and monitor cables for each "SLAVE UNIT" (see MATERIALS on page 1). All CPUs and switches can then be controlled by users using OSD commands with Command Mode.

Notes:

- **Cascading is not an option in the UNIMUX-USBV-2 2 port USB KVM switch**
- **Slaves in a cascaded system must be either all single-user switches or all multi-user switches, but not a combination of both.**

Configuration

In a cascaded system no additional configuration is necessary.

Cascaded Installation

- Using the 15HD video cable ends of a USBVEXT-xx-MM cable, connect the USB KVM slave's MONITOR port to the master's VIDEO 1 port.
- Using the USB ends of the same USBVEXT-xx-MM cable, connect one of the USB slave's USB DEVICES ports to the master's CPU 1 port.

Note: Only one of the two ports labeled DEVICES on a slave needs to be used in order for cascading to work.

- Repeat step a. & b. for each additional slave, keeping in mind that each slave will connect to the next available master's port (i.e. Slave #2 to master's VIDEO 2 & CPU 2, etc.) See Fig. 35 on page 35.
- IMPORTANT:** Power On each of the slave units first, THEN the master switch. (Whether the CPUs are powered-ON or not doesn't matter, but the UNIMUX slaves must be powered-ON first.)

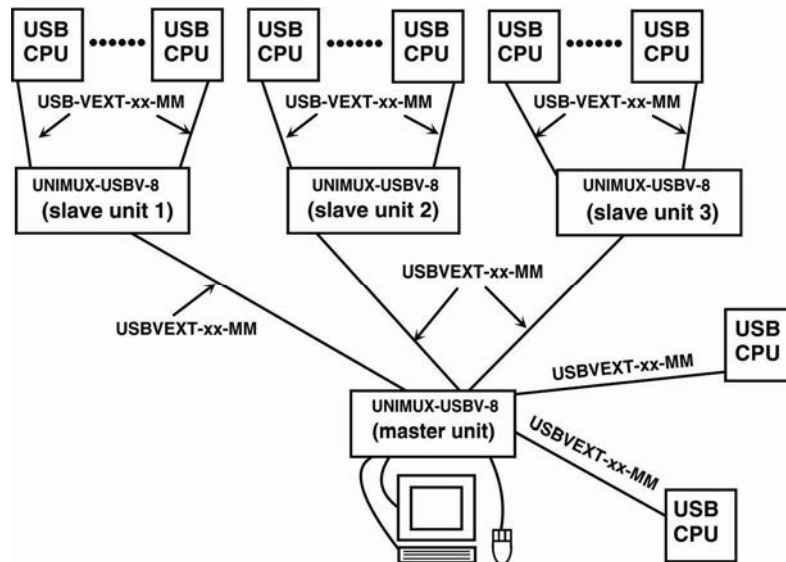

Figure 33- Connections for Cascading

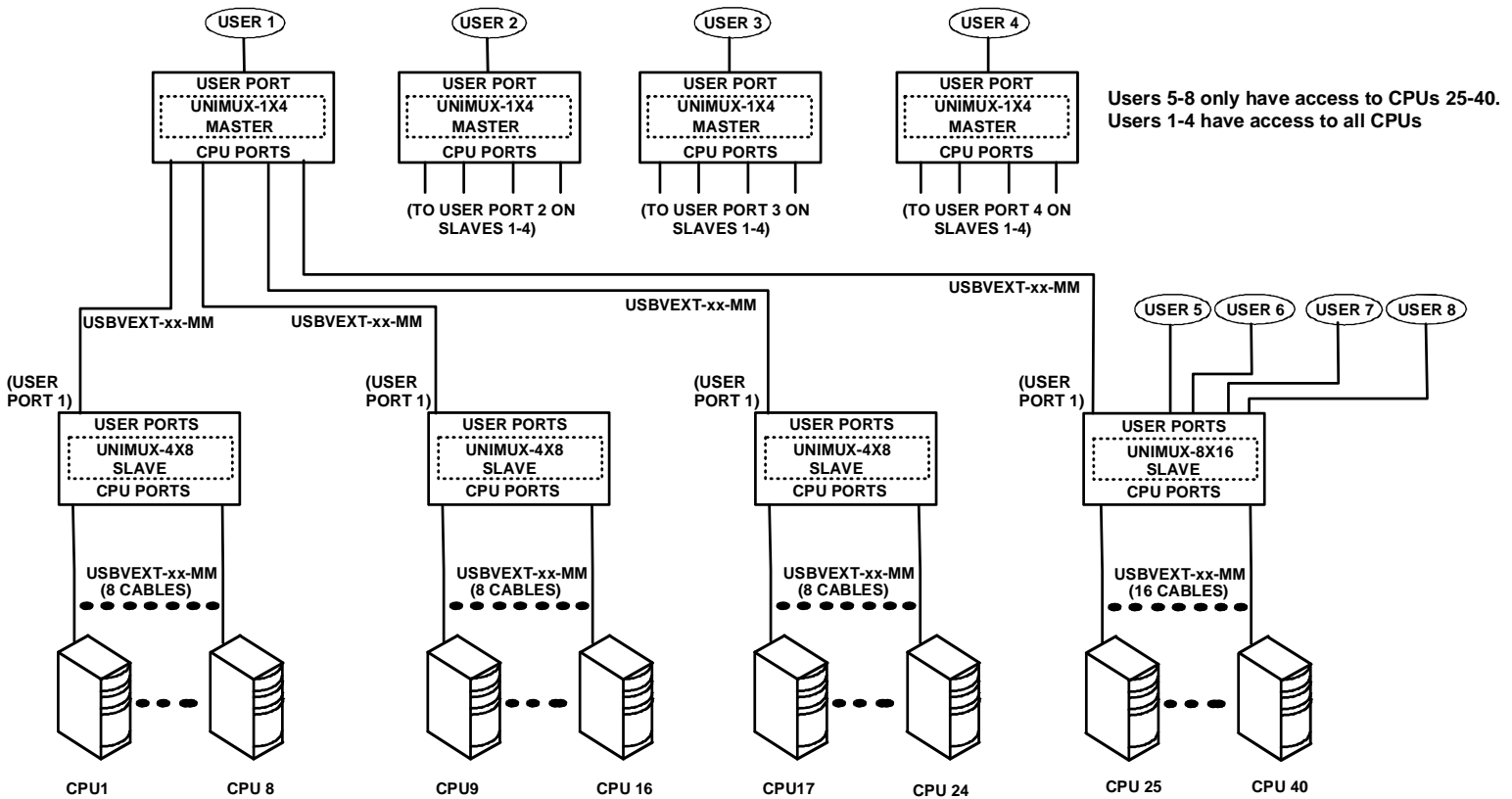

Figure 34- Cascaded configuration with multi-user slaves

FYI: Any USER and MONITOR ports on a multi-user switch connected as a slave that do not get connected to the master can be connected to by users (for example users 5-8 in Fig. 30). Users connected to a slave downstream from the master will control only the CPUs directly connected to that slave switch (i.e. users 5 and 6 in Fig. 34 above can only control CPUs 25-40).

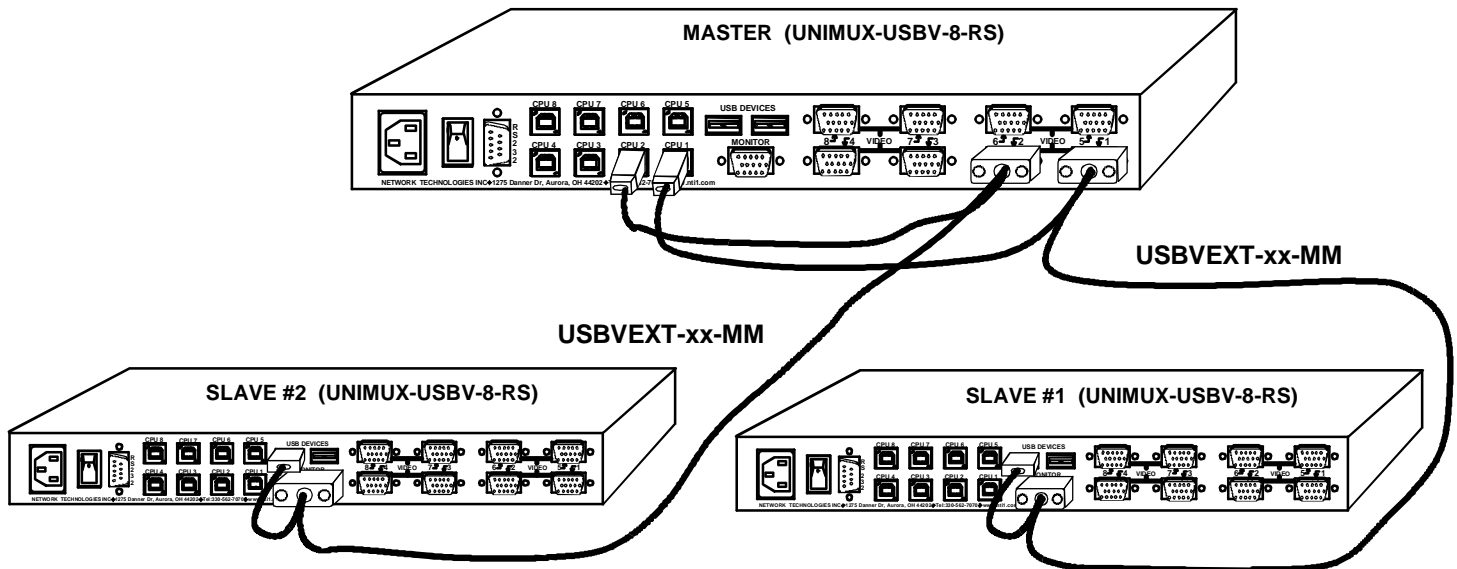

Figure 35- Master-to-slave device cable connections- single-user switches

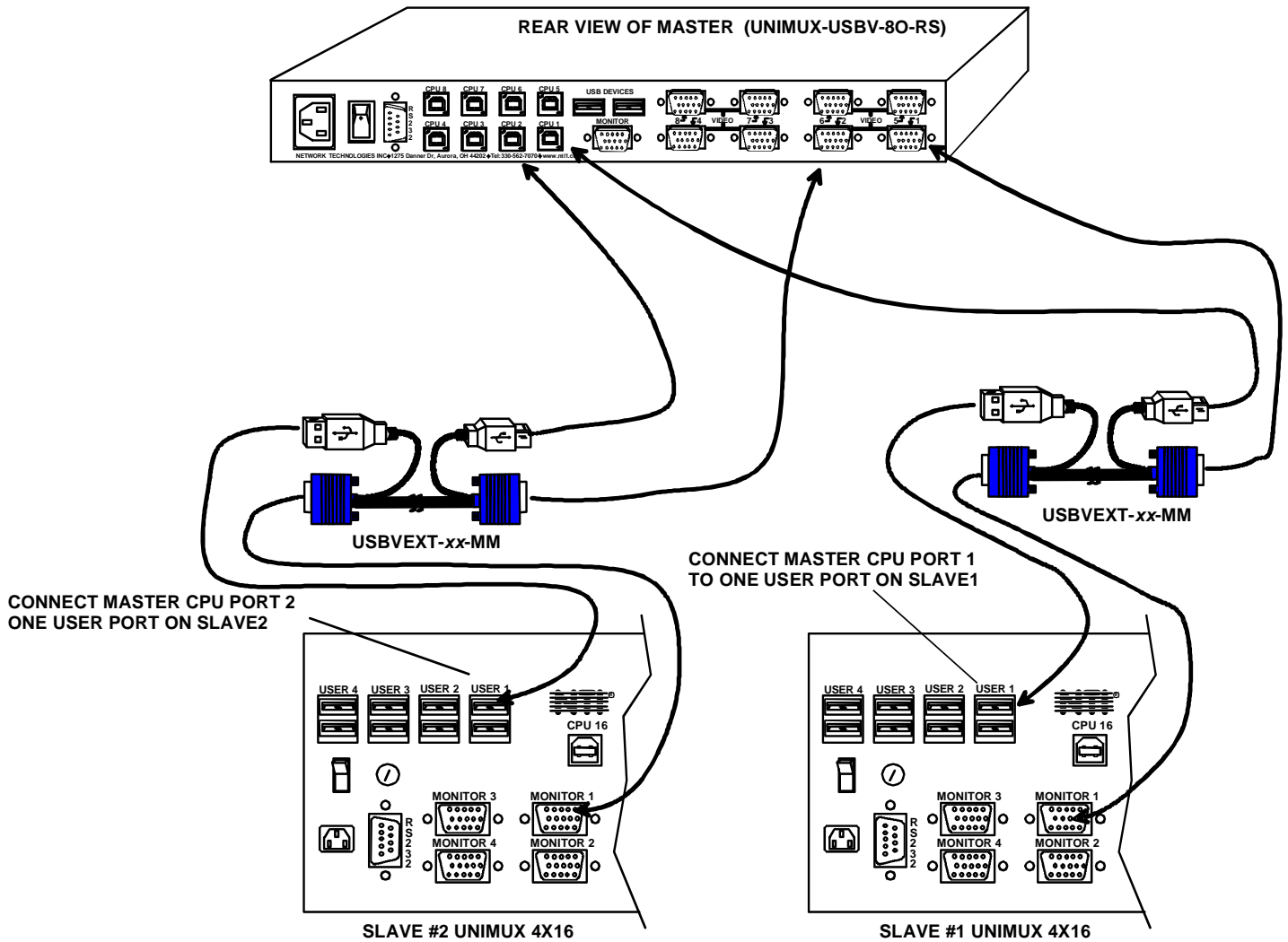

Figure 36- Master to slave cable connections- multi-user switches

Limitations

- Up to 8 slaves may be connected to form a maximum system size of 152 ports (1x32 port master + 8x16 port slaves).
- Slaves must be added to the master in order (slave #1 to master's port 1, slave #2 to master's port 2, etc).

FYI: Master Port 1 (with an 8-port Slave connected to it) will become ports 1-8 (1-4 for a 4-port slave). Master Unit Port 2 (with a second 8-port Slave Unit connected) will become port numbers 9-16 (5-8 for a 4-port slave).

- The front panel buttons are only used to operate standalone switches. To control a cascaded network of switches, only the OSD commands within Command Mode will be recognized.

Note: Cascading is not an option in the UNIMUX-USBV-2 2 port USB KVM switch.

Port Assignments in OSD

When the Master powers up with the powered-ON Slave switches connected, you will need to enter Command Mode (page 12) to view the updated port list.

Port Identification Rules:

1. Index numbers will always follow the number of CPU ports connected, consecutively as they are presented by the switches.

For example, with three 1x16 slaves connected to a 1x16 Master, you will have:

Index numbers **1-16** assigned to ports for the switch connected to Master port 1.

Index numbers **17-32** assigned to ports for the switch connected to Master port 2,

Index numbers **33-48** assigned to the ports for the switch connected to Master port 3.

The CPUs connected to Master ports 4 thru 16 in this scenario would then have Index numbers **49-61**.

2. Port names, by default, will follow the switches they are attached to. If you connect three 1x16 slaves, you will have three ports named "Port 01", three named "Port 02", three named "Port 03", and so on. (See below.)

For this reason, when connecting Slave switches to a Master switch, we recommend that Slaves be connected to consecutive ports (the first to Master port 1, the second to Master port 2, and so on). Once they are connected, renaming the ports to something meaningful for the switches they pertain to will help keep their identities/locations easier to remember in the Command Mode list.

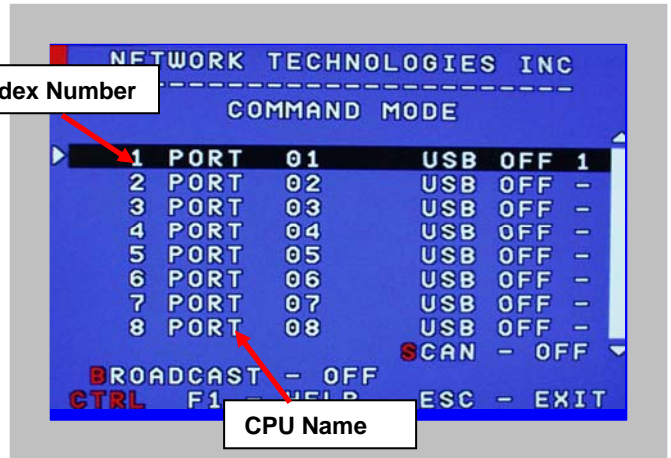

Skipping Ports when connecting Slave Units makes port management more difficult.

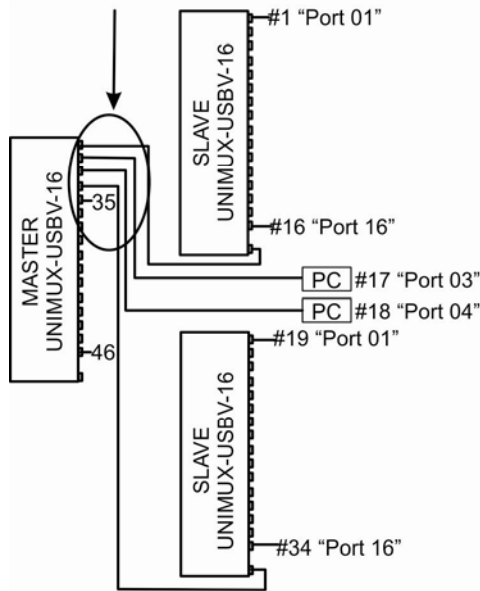

Connect Slaves to Master at consecutive ports for easier port management.

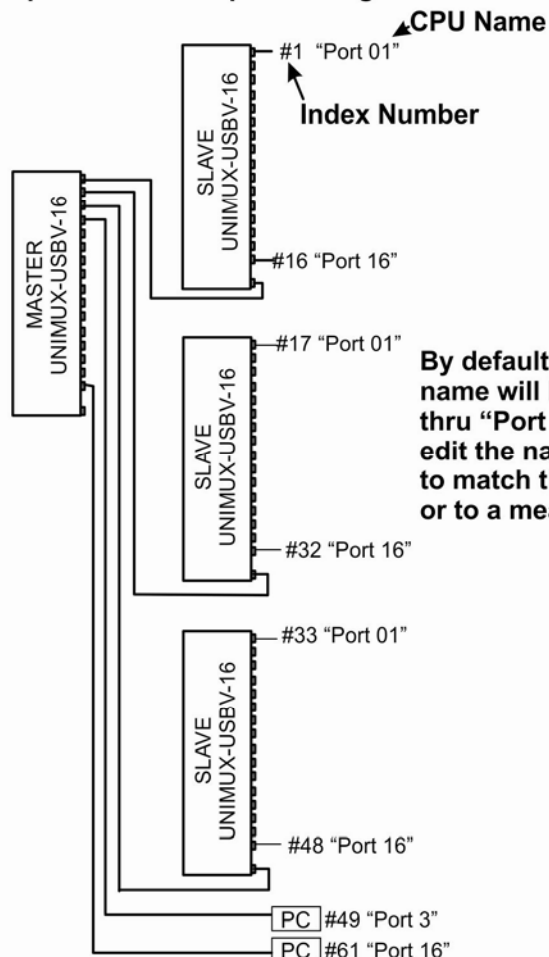

By default, the CPU name will be "Port 01" thru "Port 16" until you edit the names, perhaps to match the index numbers, or to a meaningful reference.

Figure 37- Slave Port Identification

AUDIO SUPPORT

(Optional)

Models with audio support include 3.5mm stereo jacks for connection to audio sources and an output device. Audio from either the same sources as the video, keyboard, and mouse or from separate sources (any standard line level audio (4Vp-p)) will be heard through devices such as self-powered stereo speakers or headphones.

Audio signals are switched along with the keyboard, mouse and video signals using the buttons on the UNIMUX switch. Connections to "AUDIO IN" ports will switch at the same time as like-numbered "VIDEO" and "CPU" ports when controlling the switch. For example, if "VIDEO 1" is switched to "VIDEO 2", then "AUDIO IN 1" will also switch to "AUDIO IN 2".

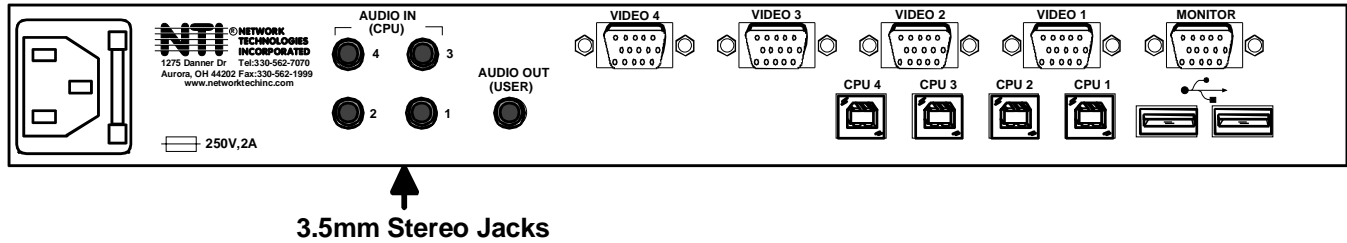

Figure 38- Rear View of UNIMUX-USBV-40-A

TROUBLESHOOTING

- PROBLEM:** Keyboard Errors
SOLUTION: Check cable connections on each CPU and the switch.
- PROBLEM:** No Video
SOLUTION: Check cable connections on each CPU and the switch. Verify that keyboard and video connect from each CPU to matching ports. After reconnecting, CPU may need to be re-booted in order to sense the monitor connection.
- PROBLEM:** No Mouse Movement
SOLUTION: Check cable connections of mouse. Verify that mouse driver was loaded.
SOLUTION: Broadcast Mode is ON. Turn OFF Broadcast Mode.
- PROBLEM:** Front pushbuttons are not working
SOLUTION: Unit in Security mode. User not authorized to access switch. Log-in with authorized name and password.
- PROBLEM:** No RS232 communication
SOLUTION: Using null modem cable. Change cable to straight-through type (see page 38).
SOLUTION: DIP switch settings are not correct for computer baud rate. Set DIP switches to desired baud rate and power cycle the switch (see page 26).
- PROBLEM:** No keyboard and mouse
SOLUTION: Unit is in Command Mode. Press <Esc> key until Command Mode LED on UNIMUX is OFF
SOLUTION: USB lock-up- Hot plug the keyboard and mouse
SOLUTION: USB lock-up- Hot plug the USB cable from the computer
SOLUTION: UNIMUX lock-up- Power cycle the UNIMUX switch

RS232 CONNECTION CABLES

Pinout of RS232 port on UNIMUX

The UNIMUX RS232 serial port is a DB-9F (female) connector configured as a DCE (data communication equipment) port. The RS232 port interface signals are listed below, including equivalent CCITT V.24 identification, and signal direction:

DB-9F pin #	Common name	EIA name	CCITT name	Function	Direction
1	N/a	N/a	N/a	No connection	--
2	TxD	BA	103	Transmit Data	Output
3	RxD	BB	104	Receive Data	Input
4	DSR	CC	107	Data Set Ready	Input
5	SG	AB	102	Signal Ground	-
6	DTR	CD	108.2	Data Terminal Ready	Output
7	CTS	CB	106	Clear To Send	Input
8	RTS	CA	105	Request To Send	Output
9	N/a	N/a	N/a	No connection	--

Specifications for Straight-Through Serial Cable for CPU Connection

UNIMUX to PS2 or SUN CPU (9 PIN)

UNIMUX 9 pin		Signal Direction	PS/2 or SUN CPU 9 pin	
Function	Pin #		Pin #	Function
RxD	3	←	3	TxD
TxD	2	→	2	RxD
CTS	7	←	7	RTS
RTS	8	→	8	CTS
DSR	4	←	4	DTR
DTR	6	→	6	DSR
SG	5	—	5	SG

UNIMUX to MAC CPU (25 PIN)

UNIMUX 9 pin		Signal Direction	MAC CPU 25 pin	
Function	Pin #		Pin #	Function
RxD	3	←	2	TxD
TxD	2	→	3	RxD
CTS	7	←	4	RTS
RTS	8	→	5	CTS
DSR	4	←	20	DTR
DTR	6	→	6	DSR
SG	5	—	7	SG

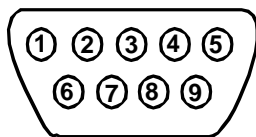
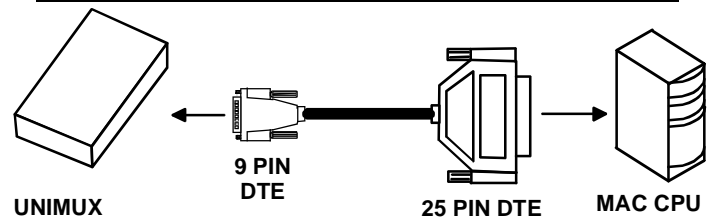
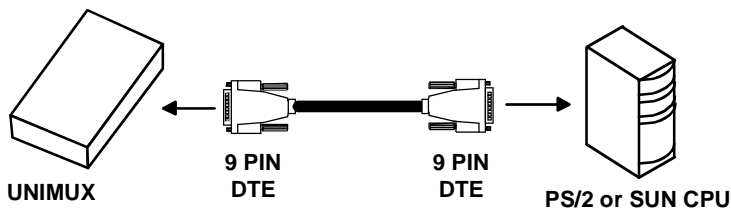

Mating Face of a 9D Male

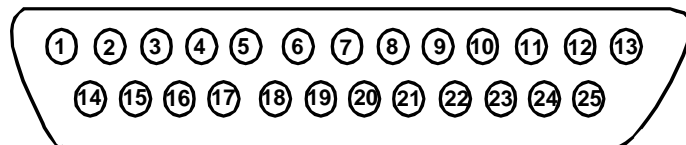

Mating Face of DB25 Male

INDEX

- administration mode, 14
- administrator login, 12
- alternate command hot key, 16
- Audio support**, 37
- basic command mode, 9
- baud rate**, 26
- Broadcast Mode, 19
- cascading, 33
- change administrator password, 14
- Change Settings, 21
- control methods, 8
- default password, 12
- devices supported, 1
- display information, 25
- edit user, 15
- features, 3
- front panel control, 8
- Help Mode, 25
- installation, 5
- international layouts, 22
- keyboard configuration, 31
- keyboard control, 8
- limitations, 7
- MAC Ports Configuration, 22
- Maintenance Mode, 24
- NTI Switch Control Program**, 29
- options available, 1
- OSD command mode**, 12
- Rack mounting**, 4
- RS232**, 26
- RS232 cable, 38
- RS232 commands**, 27
- Scan Mode, 19
- Search Mode, 23
- Security option**, 12
- Select Language, 22
- Select Ports For Broadcasting, 21
- Select Ports For Scanning, 22
- SerTest, 29
- SUN's additional keys, 31
- unit address, 27
- usage statistics, 17
- user access functions, 18
- user login, 13
- user name list, 15

WARRANTY INFORMATION

The warranty period on this product (parts and labor) is two (2) years from the date of purchase. Please contact Network Technologies Inc at **(800) 742-8324** (800-RGB-TECH) or **(330) 562-7070** or visit our website at <http://www.networktechinc.com/return-policy.html> for information regarding repairs and/or returns. A return authorization number is required for all repairs/returns.