



**Zenty | Professional A/V Solution Provider**

## User Manual [v1.0]



### IP300 4K@60Hz 4:2:0 AV over IP System

ZT-157 | ZT-IP300E

ZT-158 | ZT-IP300D



ZENTY®  
9807 EMILY LANE  
STAFFORD, TX 77477  
(844) 200-1945  
SUPPORT@ZENTY.COM

# Important Safety Instructions



**1.** Do not expose this apparatus to rain, moisture, dripping or splashing and that no objects filled with liquids, such as vases, shall be placed on the apparatus.



**6.** Clean this apparatus only with dry cloth.



**2.** Do not install or place this unit in a bookcase, built-in cabinet or in another confined space. Ensure the unit is well ventilated.



**7.** Unplug this apparatus during lightning storms or when unused for long periods of time.



**3.** To prevent risk of electric shock or fire hazard due to overheating, do not obstruct the unit's ventilation openings with newspapers, tablecloths, curtains, and similar items.



**8.** Protect the power cord from being walked on or pinched particularly at plugs.



**4.** Do not install near any heat sources such as radiators, heat registers, stoves, or other apparatus (including amplifiers) that produce heat.



**9.** Only use attachments / accessories specified by the manufacturer.



**5.** Do not place sources of naked flames, such as lighted candles, on the unit.



**10.** Refer all servicing to qualified service personnel.

# Table of Contents

1. Overview .....	5
2. Features.....	5
2.1 ZT-IP300E .....	5
2.2 ZT-IP300D.....	7
3. Package Contents.....	9
3.1 ZT-IP300E .....	9
3.2 ZT-IP300D.....	10
4. Specifications .....	10
4.1 ZT-IP300E .....	11
4.2 ZT-IP300D.....	14
5. Panel Description .....	17
5.1 ZT-IP300E .....	17
5.2 ZT-IP300D.....	22
6. Typical Applications .....	26
6.1 Scenarios 1 .....	26
6.2 Scenarios 2.....	27
7. Hardware Installation .....	28
8. Operating the Devices.....	28
8.1 Introduction to Different Operation Tools .....	28
8.2 Using DIP Switch to Perform Routing.....	30
8.3 Using PC Configurator to Perform Fast Switching .....	30
9. Updating the Firmware .....	30
10. Maintenance.....	30
11. Warranty.....	30

12. Mail-In Service .....31  
13. Limited Warranty Limits and Exclusions .....31

# 1. Overview

IP300 series encoders (ZT-IP300E) and decoders (ZT-IP300D) provide the flexible, powerful, and scalable solution at resolutions up to 3840 x 2160@60Hz 4:2:0, 3840 x 2160@30Hz 4:4:4. They allow 4K UHD media to be switched and distributed over standard gigabit

Ethernet networks, providing complete end-to-end streaming systems. Audio, video together with IR, and USB signals can be routed separately or as a whole throughout the matrix system. Encoders can be used with decoders to function video wall up to the dimensions of 16 x 16. Both of them have the capacity to handle and output up to 7.1 channel audio, allowing you to enjoy the finest sound.

HDCP 2.2 specifications are employed. A local area network is covered with a range up to 328 ft (100 m) over a single Cat 5e cable or above. Standard features like, bi-directional serial, bi-directional IR, and independent analog audio input/output are included. The codecs allow USB extension to take place to control a keyboard and a mouse. IP300 series offer integration-friendly control features—the front panel link DIP switch, Windows PC configurator (Z-Net Console), Z-Net on iPad and IP controller (ZT-IP100C) providing simple, flexible control and management options. They are the perfect solution for any low latency and signal routing applications. Common applications include homes, classrooms, conference rooms, and broadcasts.

## 2. Features

### 2.1 ZT-IP300E

- Distributes and switches 4K UHD AV signals via standard gigabit Ethernet networks
- Input: one HDMI input and one analog audio input
- Output: one local HDMI loop-through, one gigabit Ethernet output and one analog audio output

- Supports HDMI input resolutions up to 3840 x 2160@60Hz 4:2:0
- Supports streaming resolutions up to 3840 x 2160@30Hz 4:4:4
- Supports 7.1 channel audio
- HDCP 2.2 compliant
- Uses with ZT-IP300D units to features video wall up to the dimensions of 16 x 16
- Flexible routing policies, allowing audio, video together with IR, and USB signals to be routed separately or as a whole throughout the matrix system
- Capable of outputting IP streams that can easily be decoded and viewed on the multiple decoders
- Allows AV, USB, IR, RS232 and power signals to be delivered up to 328 ft (100 m) over a single Cat 5e cable or above
- Supports HDMI input and output transmission distance up to 50 ft (15 m)
- 1 ~ 2 fps latency
- Supports independent analog audio input and output at 2 channels, 24 bits@48 kHz/channel
- Supports bi-directional IR, allowing control of remote source and display devices from both sides of encoders and decoders
- Offers a USB type B port to directly connect to a PC and complies with USB 2.0 standard
- Offers point-to-point, point-to-multipoint, multipoint-to-point, multipoint-to-multipoint applications
- Supports PoE to be remotely powered by compatible power source equipment such as a PoE-

enabled Ethernet switch, eliminating the need for a nearby power outlet

- Features CEC function, remotely allowing the TVs to be set to turn on and enter standby mode using IP controller's API commands
- Supports Auto-IP, zero-configuration networking (zeroconf), a set of special technologies that automatically assign dynamic IP addresses to the devices on startup and a server-less method of choosing an IP address
- Works with multiple operation tools, the front panel link DIP switch, Windows PC configurator, Z-Net on iPad and IP controller for device control, device management, and device upgrade
- Supports communications protocols used on the Ethernet such as TCP/IP, ARP, DHCP, ICMP (ping), IGMP, UDP

## **2.2 ZT-IP300D**

- Supports live IP video stream decoding, working with ZT-IP300E to provide complete end-to-end streaming systems
- Input: one Ethernet input
- Output: one HDMI output and one analog audio output
- Supports streaming and HDMI output resolutions up to 3840 x 2160@30Hz 4:4:4
- Supports 7.1 channel audio
- HDCP 2.2 compliant
- User-selectable output HDCP configuration via PC configurator
- Uses with ZT-IP300E units to features video wall up to the dimensions of 16 x 16

- Flexible routing policies, allowing audio, video together with IR, and USB signals to be routed separately or as a whole throughout the matrix system
- Allows AV, USB, IR, RS232 and power signals to be delivered up to 328 ft (100 m) over a single Cat 5e cable
- Allows video output to follow input resolution or to convert the input resolution to 3840 x 2160@30Hz 4:4:4 and 1080p@60Hz
- Supports HDMI output transmission distance up to 50 ft (15 m)
- 1 ~ 2 fps latency
- Supports independent analog audio output at 2 channels, 24 bits@48 kHz/channel
- Supports bi-directional serial, allowing control of remote RS232 devices from both sides of decoders and IP controller
- Supports bi-directional IR, allowing control of remote source and display devices from both sides of encoders and decoders
- Offers two USB type A ports to directly connect to a keyboard and a mouse and complies with USB 2.0 standard, providing +5 VDC at up to 500 mA to connected USB peripherals.
- Offers point-to-point, point-to-multipoint, multipoint-to-point, multipoint-to-multipoint applications
- Supports PoE to be remotely powered by compatible power source equipment such as a PoE-enabled Ethernet switch, eliminating the need for a nearby power outlet
- Fit in/stretch out video wall, and rotate video management — Decoded video can fill a video wall, maintain aspect ratio in a video wall, or can be rotated 180 and 270 degrees clockwise, presenting imagery that meets customer expectations.



- Features CEC function, remotely allowing the TVs to be set to turn on and enter standby mode using IP controller's API commands
- Supports Auto-IP, zero-configuration networking (zeroconf), a set of special technologies that automatically assign dynamic IP addresses to the devices on startup and a server-less method of choosing an IP address
- Works with multiple operation tools, the front panel link DIP switch, Windows PC configurator, Z-Net on iPad and IP controller for device control, device management, and device upgrade
- Supports communications protocols used on the Ethernet such as TCP/IP, ARP, DHCP, ICMP (ping), IGMP, UDP

## **3. Package Contents**

### **3.1 ZT-IP300E**

- (1) x ZT-IP300E Unit
- (1) x Power Adapter (12 VDC 1A)
- (1) x Detachable Plug
- (1) x Phoenix Port (Male, 3.5 mm, 3 pins)
- (1) x IR Emitter (3.9 ft/1.2 m)
- (1) x IR Wideband Receiver (3.9 ft/1.2 m, 30 kHz ~ 50 kHz)
- (2) x Mounting Ear

### 3.2 ZT-IP300D

- (1) x ZT-IP300D Unit
- (1) x Power Adapter (12 VDC 1A)
- (1) x Detachable Plug
- (1) x Phoenix Port (Male, 3.5 mm, 3 pins)
- (1) x IR Emitter (3.9 ft/1.2 m)
- (1) x IR Wideband Receiver (3.9 ft/1.2 m, 30 kHz ~ 50 kHz)
- (2) x Mounting Ear

## 4. Specifications

4K Specifications		
Max. 4K Capabilities		
Resolution and Frame Rate	Chroma Sampling	Max. Bit Depth per Color
3840 x 2160@30Hz	4:4:4	8 bit
3840 x 2160@60Hz	4:2:0	
Frame Rate	24, 30, 50 or 60 fps <b>Note:</b> <ul style="list-style-type: none"><li>• 3840 x 2160@50Hz and 60Hz can only support 4:2:0 chroma sampling.</li><li>• ZT-157 features all the capabilities above while ZT-158 is not compatible with 3840 x 2160@50Hz and 60Hz.</li></ul>	
Chroma Sampling	4:4:4: or 4:2:0	
Color Bit Depth	8 bits per color	
Signal Type	HDMI	
Max. Video Data Rate	8.91 Gbps (2.97 Gbps per color)	

## 4.1 ZT-IP300E

Video	
Maximum Data Rate	8.91 Gbps (2.97 Gbps per color)
Maximum Pixel Clock	297 MHz
Color Bit Depth	8 bits per color
Formats	RGB and YCbCr digital video
Standards	HDMI 1.4, HDCP 2.2, VESA, CEA-861F

Input Video Port	1 x female HDMI type A (19 pins)
Input Video Type	HDMI, HDCP
Input Video Resolutions	<p>3840 x 2160p@24Hz 4:4:4,            3840 x 2160p@30Hz 4:4:4,            3840 x 2160p@50Hz 4:2:0,            3840 x 2160p@60Hz 4:2:0,            640 x 480p@60Hz, 720 x 480p@60Hz            1280 x 720p@60Hz, 1920 x 1080i@60Hz,            1920 x 1080p@60Hz, 720 x 576p@50Hz            1280 x 720p@50Hz, 1920 x 1080i@50Hz            1920 x 1080p@50Hz, 1920 x 1080p@24Hz            1920 x 1080p@25Hz 640 x 480@60Hz,            800 x 600@60Hz</p> <p>1024 x 768@60Hz, 1280 x 720@60Hz            1280 x 768@60Hz, 1280 x 800@60Hz            1280 x 960@60Hz, 1280 x 1024@60Hz            1360 x 768@60Hz, 1366 x 768@60Hz            1400 x 1050@60Hz, 1440 x 900@60Hz            1600 x 900@60Hz, 1600 x 1200@60Hz            1680 x 1050@60Hz, 1920 x 1080@60Hz            1920 x 1200@60Hz</p>
Average Encoding Data Rate	<ul style="list-style-type: none"> <li>• 3840 x 2160@30Hz: about 250 Mbps</li> <li>• 1080p@60Hz: about 150 Mbps</li> </ul>
End-to-End Time Latency	1 ~ 2 fps
Input Video Signal	0.5~1.2 V p-p
Input DDC Signal	5 V p-p (TTL)
Video Impedance	100 Ω

Output Video	
Output Video Port	<b>HDMI loop-through: (local output)</b> 1 x female HDMI type A (19 pins)  <b>Ethernet output:</b> 1 x female RJ-45
Output Video Type	<b>HDMI loop-through: (local output)</b> HDMI, HDCP  <b>Ethernet output:</b> IP stream
Output Video Resolutions	<b>HDMI loop-through: (local output)</b> Up to 3840 x 2160@60Hz 4:2:0  <b>Ethernet output:</b> Up to 3840 x 2160@30Hz 4:4:4
Output Video Signal	0.5~1.2 V p-p
Output DDC Signal	5 V p-p (TTL)
Video Impedance	100 $\Omega$

Audio (Analog Audio)	
Gain	Unbalanced output: 0 dB
Frequency Response	20 Hz to 20 kHz, $\pm 1$ dB
THD + Noise	-78 dBFS typical at -5.2 dBV input
SNR	> 85 dBFS at input (A-weighted)
Stereo Channel Separation	> 80 dB
Digital Sampling Rate	48 kHz
Bit Depth	24 bits

Input Audio	
<b>Digital audio input:</b>	
Input Audio Port	1 x female HDMI type A (19 pins)
Signal Format	Dolby 5.1/Dolby True HD/Dolby Digital Plus, DTS 5.1/DTS HD/DTS True HD, LPCM2.0/LPCM2.1/LPCM5.1/LPCM 7.1
<b>Analog audio input:</b>	
Number/	1 PC level stereo, unbalanced

Input Audio	
Signal Type	
Input Audio Port	1 x 3.5 mm stereo jack, 2 channel; tip (L), ring (R), sleeve (ground)
Signal Format	Analog
Impedance	>10k ohms, AC coupled
Nominal Level	-4.2 dBV (617 mVrms)

Output Audio	
<b>Digital audio output:</b>	
Output Audio Port	<b>HDMI loop-through: (local output)</b> 1 x female HDMI type A (19 pins)  <b>Ethernet output:</b> 1 x female RJ-45
Signal Format	<b>HDMI loop-through: (local output)</b> Dolby 5.1/Dolby True HD/Dolby Digital Plus, DTS 5.1/DTS HD/DTS True HD, LPCM2.0/LPCM2.1/LPCM5.1/LPCM 7.1  <b>Ethernet output:</b> Dolby 5.1/Dolby True HD/Dolby Digital Plus, DTS 5.1/DTS HD/DTS True HD, LPCM2.0/LPCM2.1/LPCM5.1/LPCM 7.1
<b>Analog audio output:</b>	
Number/ Signal Type	1 PC level stereo, unbalanced
Output Audio Port	1 x 3.5 mm stereo jack, 2 channel; tip (L), ring (R), sleeve (ground)
Signal Format	Analog
Impedance	>20 ohms, DC coupled
Nominal Level	-3.47 dBV (670 mVrms)

Control & Management	
Control & Management Method	the front panel link DIP switch,  Windows PC configurator (HDMI over IP Console),  VisualM on iPad, IP controller (SC009)

General	
Operating Temperature/ Humidity	+32°F ~ +113°F (0°C ~ +45°C) 10% ~ 90%, non-condensing
Storage Temperature/ Humidity	-4°F ~ +158°F (-20°C ~ +70°C) 10% ~ 90%, non-condensing
Power	12 VDC 1 A
Power Consumption	About 6 W (Powered via either PoE or a power adapter)
ESD Protection	Human body model: <ul style="list-style-type: none"> <li>±8 kV (air-gap discharge)</li> <li>±4 kV (contact discharge)</li> </ul>
Surge Protection	Voltage: ±1 kV
Group Pulse Protection	Voltage: ±2 kV
Case Dimensions (W x H x D)	12.2" x 3.0" x 7.1" (310 mm x 76 mm x 180 mm)
Unit Dimensions (W x H x D)	8.7" x 1.0" x 5.1" (220 mm x 25 mm x 130.2 mm)
Unit Weight (Without accessories)	1.63 lbs. (0.74 kg)
Certification	CE, FCC, RoHS compliant

## 4.2 ZT-IP300D

Video	
Maximum Data Rate	8.91 Gbps (2.97 Gbps per color)
Maximum Pixel Clock	297 MHz
Color Bit Depth	8 bits per color
Formats	RGB and YCbCr digital video
Standards	HDMI 1.4, HDCP 2.2, VESA, CEA-861-F

Input Video	
Input Video Port	1 x female RJ-45
Input Video Type	IP stream
Input Video Resolutions	Up to 3840 x 2160@30Hz 4:4:4

Output Video	
Output Video Port	1 x female HDMI type A (19 pins)
Output Video Type	HDMI, HDCP
Output Video Resolutions	Up to 3840 x 2160@30Hz 4:4:4
End-to-End Time Latency	1 ~ 2 fps
Output Video Signal	0.5~1.2 V p-p
Output DDC Signal	5 V p-p (TTL)
Video Impedence	100 $\Omega$

Audio (Analog Audio)	
Gain	Unbalanced output: 0 dB
Frequency Response	20 Hz to 20 kHz, $\pm 1$ dB
THD + Noise	-78 dBFS typical at -5.2 dBV input
SNR	> 85 dBFS at input (A-weighted)
Stereo Channel Separation	> 80 dB
Digital Sampling Rate	48 kHz
Bit Depth	24 bits

Input Audio	
<b>Digital audio input:</b>	
Input Audio Port	1 x female RJ-45
Signal Format	Dolby 5.1/Dolby True HD/Dolby Digital Plus, DTS 5.1/DTS HD/DTS True HD, LPCM2.0/LPCM2.1/LPCM5.1/LPCM 7.1

Output Audio	
<b>Digital audio output:</b>	
Output Audio Port	1 x female HDMI type A (19 pins)
Signal Format	Dolby 5.1/Dolby True HD/Dolby Digital Plus, DTS 5.1/DTS HD/DTS True HD, LPCM2.0/LPCM2.1/LPCM5.1/LPCM 7.1
<b>Analog audio output:</b>	
Number/ Signal Type	1 PC level stereo, unbalanced
Output Audio Port	1 x 3.5 mm stereo jack, 2 channel; tip (L), ring (R), sleeve (ground)
Signal Format	Analog <b>Note:</b> Only when PCM digital or analog signals are input in encoder, this audio output port can output audio signals.
Impedance	>20 ohms, DC coupled
Nominal Level	-3.47 dBV (670mVrms)

Control & Management	
Control & Management Method	the front panel link DIP switch, Windows PC configurator (HDMI over IP Console), VisualIM on iPad, IP controller (SC009)

General	
Operating Temperature/ Humidity	+32°F ~ +113°F (0°C ~ +45°C) 10% ~ 90%, non-condensing
Storage Temperature/ Humidity	-4°F ~ +158°F (-20°C ~ +70°C) 10% ~ 90%, non-condensing
Power	12 VDC 1 A
Power Consumption	About 4 W (Powered via either PoE or a power adapter)
ESD Protection	Human body model: <ul style="list-style-type: none"> <li>• ±8 kV (air-gap discharge)</li> <li>• ±4 kV (contact discharge)</li> </ul>
Surge Protection	Voltage: ±1 kV
Group Pulse Protection	Voltage: ±2 kV



Case Dimensions (W x H x D)	12.2" x 3.0" x 7.1" (310 mm x 76 mm x 180 mm)
Unit Dimensions (W x H x D)	8.7" x 1.0" x 5.1" (220 mm x 25 mm x 130.2 mm)
Unit Weight (without accessories)	1.63 lb (0.74 kg)
Certification	CE, FCC, RoHS compliant

## 5. Panel Description

### 5.1 ZT-IP300E





No.	Name	Description	
1	POWER Indicator	On	ZT-IP300E is powered on.
		Off	ZT-IP300E is powered off.
2	STATUS Indicator	Solid On	ZT-IP300E is connected to both an active video source and ZT-IP300D.
		Blinking	<ul style="list-style-type: none"> <li>ZT-IP300E is disconnected from an active video source.</li> <li>ZT-IP300E is disconnected from ZT-IP300D.</li> </ul>
		Off	<ul style="list-style-type: none"> <li>ZT-IP300E is powered off.</li> <li>ZT-IP300E is in the boot process.</li> <li>Network is down.</li> </ul>
3	Working Mode Switch	<b>MODE:</b> use this switch to toggle between normal and debug modes.	
		NORMAL (Default)	In this mode, you can connect the rear panel RS232 port to a RS232 device such as a computer for bi-directional serial communication with a RS232 device on the IP controller side.

No.	Name	Description
		<b>DEBUG</b> In this mode, you can connect the rear panel RS232 port to a RS232 device such as a computer for debugging ZT-IP300E.
4	Link DIP Switch 	<b>DIP:</b> this DIP switch consists of four manual switches, which are used to route audio, video together with IR, and USB signals between ZT-IP300E and ZT-IP300D based on their positions. By default, each individual switches is in the up position. For more information, see "Using DIP Switch to Perform Routing". <b>Note:</b> For the DIP switches in both encoder and decoder, changes to them take effect immediately without rebooting the system.

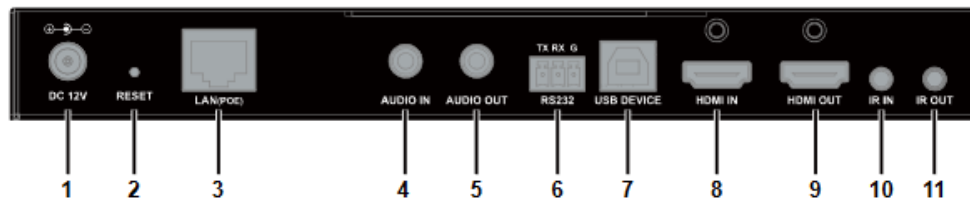
### Rear Panel



No.	Name	Description
1	Power Input	<b>DC 12V:</b> connect this port to the supplied 12 V 1 A power adapter.
2	Reset Button (Recessed)	<b>RESET:</b> use this button to reset device. When ZT-IP300E is powered on, use a pointed stylus to hold down the RESET button for five or more seconds, and then release it, it will reboot and restore to its factory defaults. <b>Note:</b> When the settings are restored, your custom data is lost. Therefore, exercise caution when using the RESET button.
3	IP Stream	<b>LAN (POE):</b> 10/100/1000 Base-T port, connect

No.	Name	Description												
	Output	<p>this port to a gigabit Ethernet switch for IP stream output, device control and device management.</p> <p><b>Default protocol:</b></p> <table border="1"> <tr> <td>IP address:</td> <td>169.254.x.x</td> </tr> <tr> <td>Subnet mask:</td> <td>255.255.0.0</td> </tr> <tr> <td>DHCP:</td> <td>Off</td> </tr> <tr> <td>Auto-IP:</td> <td>On (Default)</td> </tr> <tr> <td>Link speed and duplex level:</td> <td>Auto-detected</td> </tr> </table> <p><b>RJ-45 port LEDs:</b></p> <table border="1"> <tr> <td></td> <td> <p><b>Link LED (Left):</b> This green LED lights to indicate a good network connection.</p> <p><b>Activity LED (Right):</b> This yellow LED blinks to indicate network activity.</p> </td> </tr> </table> <p><b>Note:</b></p> <p>For both encoder and decoder,</p> <ul style="list-style-type: none"> <li>Each device can be powered by a PoE-enabled Ethernet switch via the RJ-45 port, eliminating the need for a nearby power outlet.</li> <li>Power supply via a power adapter has higher priority as compared to PoE power supply. When the device is connected to both the supplied power adapter and the PoE-enabled Ethernet switch, it receives power from the power adapter instead of the switch.</li> </ul>	IP address:	169.254.x.x	Subnet mask:	255.255.0.0	DHCP:	Off	Auto-IP:	On (Default)	Link speed and duplex level:	Auto-detected		<p><b>Link LED (Left):</b> This green LED lights to indicate a good network connection.</p> <p><b>Activity LED (Right):</b> This yellow LED blinks to indicate network activity.</p>
IP address:	169.254.x.x													
Subnet mask:	255.255.0.0													
DHCP:	Off													
Auto-IP:	On (Default)													
Link speed and duplex level:	Auto-detected													
	<p><b>Link LED (Left):</b> This green LED lights to indicate a good network connection.</p> <p><b>Activity LED (Right):</b> This yellow LED blinks to indicate network activity.</p>													
4	Audio Input	<p><b>AUDIO IN:</b> connect this 3.5 mm stereo tip-ring-sleeve port to an audio input device such as a computer to accept unbalanced, stereo audio signals.</p>												

No.	Name	Description
		<div data-bbox="678 237 922 384" data-label="Diagram"> <p>The diagram shows a cross-section of a TRS connector. The central pin is labeled 'Tip (L)'. The middle ring is labeled 'Ring (R)'. The outer sleeve is labeled 'Sleeve (ground)'. A dashed line indicates the internal wiring path.</p> </div> <p data-bbox="516 363 649 430">TRS Connector</p> <p data-bbox="678 401 751 430"><b>Note:</b></p> <p data-bbox="743 441 1104 562">This connector illustration applies to both analog audio input and output in ZT-IP300E and ZT-IP300D</p> <p data-bbox="516 573 589 602"><b>Note:</b></p> <p data-bbox="581 613 1117 892">When this audio port is connected to an audio input device, both encoder and decoder will output the audio device's audio signals instead of that from the HDMI video source. If this audio port is connected via an audio cable but no audio signals are input, you can get picture but no sound. The situations above do not apply to the HDMI loop-through port in encoder, which can still output the AV signals from the video source.</p>
5	Audio Output	<p data-bbox="516 903 1120 1060"><b>AUDIO OUT:</b> connect this 3.5 mm stereo tip-ring-sleeve port to an audio output device such as a speaker and amplifier to output unbalanced, stereo audio signals.</p>
6	Serial Communication	<p data-bbox="516 1071 1120 1171"><b>RS232:</b> use this port to perform bi-directional serial communication and device debug functions.</p> <ul data-bbox="516 1182 1120 1501" style="list-style-type: none"> <li data-bbox="516 1182 1120 1381">• When the front panel "MODE" switch is moved to the "NORMAL" position, connect this port to a RS232 device such as a computer to bi-directionally communicate with a RS232 device at the IP controller side.</li> <li data-bbox="516 1392 1120 1501">• When the front panel "MODE" switch is toggled to the "DEBUG" position, connect this port to a RS232 device such as a</li> </ul>

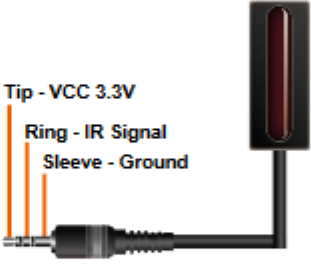
No.	Name	Description
		computer for debugging ZT-IP300E.
7	USB Port for PC	<b>USB DEVICE:</b> connect a type A male to type B male USB cable between this port and the USB port of a desktop or laptop. ZT-IP300E is USB 2.0 compliant.
8	AV Input	<b>HDMI IN:</b> connect this port to an HDMI source device.
9	Local AV Output	<b>HDMI OUT:</b> connect this port to a local HDMI display device.
10	IR Input	<p><b>IR IN:</b> connect this 3.5 mm tip-ring-sleeve port to an IR receiver for IR communication with an IR emitter in the ZT-IP300D side on the network.</p> <p><b>IR receiver:</b></p>  <p><b>Note:</b> This IR cable illustration applies to the IR input ports in ZT-IP300E and ZT-IP300D.</p>
11	IR Output	<p><b>IR OUT:</b> connect this 3.5 mm tip-sleeve port to an IR emitter for IR communication with an IR receiver in the ZT-IP300D side on the network.</p> <p><b>IR Emitter:</b></p>

No.	Name	Description
		 <p><b>Note:</b> This IR cable illustration applies to the IR output ports in ZT-IP300E and ZT-IP300D.</p>

## 5.2 ZT-IP300D

### Front Panel



No.	Name	Description	
1	POWER Indicator	On	ZT-IP300D is powered on.
		Off	ZT-IP300D is powered on.
2	STATUS Indicator	Solid On	ZT-IP300D is connected to ZT-IP300E and the video is displayed.
		Blinking	<ul style="list-style-type: none"> <li>ZT-IP300D is disconnected from ZT-IP300E.</li> <li>ZT-IP300E is disconnected from an active video source.</li> </ul>
		Off	<ul style="list-style-type: none"> <li>ZT-IP300D is powered off.</li> <li>ZT-IP300D is in the boot process.</li> <li>Network is down.</li> </ul>

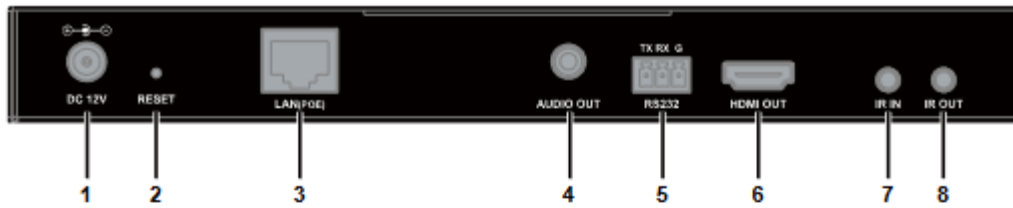

No.	Name	Description
3	Working Mode Switch	NORMAL (Default) In this mode, you can connect the rear panel RS232 port to a RS232 device such as a computer for bi-directional serial communication with a RS232 device on the IP controller side.
		DEBUG In this mode, you can connect the rear panel RS232 port to a RS232 device such as a computer for debugging ZT-IP300D.
4	Link DIP Switch 	<b>DIP:</b> this DIP switch consists of four manual switches, which are used to route audio, video together with IR, and USB signals between ZT-IP300E and ZT-IP300D based on their positions. By default, each individual switches is in the up position. For more information, see "Using DIP Switch to Perform Routing".
5	USB Port for Peripherals	<b>USB HOST:</b> connect the two USB type A ports to a USB keyboard and mouse. The connections are USB 2.0 compatible, providing +5 VDC at up to 500 mA to connected USB peripherals. <b>Note:</b> <ul style="list-style-type: none"> <li>This device supports most standard keyboard keys and mice, including standard 84/101/104 keyboard keys and most of multimedia or system control keys.</li> <li>Wired keyboards and mice are recommended for optimal performance.</li> </ul>

## Rear Panel



No.	Name	Description
1	Power Input	<b>DC 12V:</b> connect this port to the supplied 12 V 1 A power adapter.
2	Reset Button (Recessed)	<p><b>RESET:</b> use this button to reset device or quickly remove link relationship between decoder and encoder.</p> <ul style="list-style-type: none"> <li>Device reset: When ZT-IP300D is powered on, use a pointed stylus to hold down the RESET button for five or more seconds, and then release it, it will reboot and restore to its factory defaults. This function will disconnect decoder from encoder.</li> </ul> <p><b>Note:</b> When the settings are restored, your custom data is lost. Therefore, exercise caution when using the RESET button.</p> <ul style="list-style-type: none"> <li>Remove decoder and encoder link relationship quickly: When encoder is routed to decoder using PC configurator, Z-Net or IP controller, hold down the RESET button for less than five seconds, and then release it, it reverts to the link relationship between encoder and decoder set via the link DIP switch. This function applies to decoder only.</li> </ul>
3	IP Stream Input	<b>LAN (POE):</b> 10/100/1000 Base-T port, connect this port to a gigabit Ethernet switch for IP



No.	Name	Description												
		<p>stream input, device control and device management.</p> <p><b>Default protocol:</b></p> <table border="1"> <tr> <td>IP address:</td> <td>169.254.x.x</td> </tr> <tr> <td>Subnet mask:</td> <td>255.255.0.0</td> </tr> <tr> <td>DHCP:</td> <td>Off</td> </tr> <tr> <td>Auto-IP:</td> <td>On (Default)</td> </tr> <tr> <td>Link speed and duplex level:</td> <td>Auto-detected</td> </tr> </table> <p><b>RJ-45 port LEDs:</b></p> <table border="1"> <tr> <td></td> <td> <p><b>Link LED (Left):</b> This green LED lights to indicate a good network connection.</p> <p><b>Activity LED (Right):</b> This yellow LED blinks to indicate network activity.</p> </td> </tr> </table>	IP address:	169.254.x.x	Subnet mask:	255.255.0.0	DHCP:	Off	Auto-IP:	On (Default)	Link speed and duplex level:	Auto-detected		<p><b>Link LED (Left):</b> This green LED lights to indicate a good network connection.</p> <p><b>Activity LED (Right):</b> This yellow LED blinks to indicate network activity.</p>
IP address:	169.254.x.x													
Subnet mask:	255.255.0.0													
DHCP:	Off													
Auto-IP:	On (Default)													
Link speed and duplex level:	Auto-detected													
	<p><b>Link LED (Left):</b> This green LED lights to indicate a good network connection.</p> <p><b>Activity LED (Right):</b> This yellow LED blinks to indicate network activity.</p>													
4	Audio Output	<p><b>AUDIO OUT:</b> connect this 3.5 mm stereo tip-ring-sleeve port to an audio output device such as a speaker and an amplifier to output unbalanced, stereo audio signals.</p>												
5	Serial Communication	<p><b>RS232:</b> use this port to perform bi-directional serial communication and device debug functions.</p> <ul style="list-style-type: none"> <li>When the front panel "MODE" switch is moved to the "NORMAL" position, connect this port to a RS232 device such as a computer to bi-directionally communicate with a RS232 device at the IP controller side.</li> <li>When the front panel "MODE" switch is toggled to the "DEBUG" position, connect this port to a RS232 device such as a computer for debugging ZT-IP300D.</li> </ul>												
6	AV Output	<p><b>HDMI OUT:</b> connect this port to an HDMI display device.</p>												
7	IR Input	<p><b>IR IN:</b> connect this 3.5 mm tip-ring-sleeve port</p>												

No.	Name	Description
		to an IR receiver for IR communication with an IR emitter in the ZT-IP300E side on the network.
8	IR Output	<b>IR OUT:</b> connect this 3.5 mm tip-sleeve port to an IR emitter for IR communication with an IR receiver in the ZT-IP300E side on the network.

## 6. Typical Applications

### 6.1 Scenarios 1

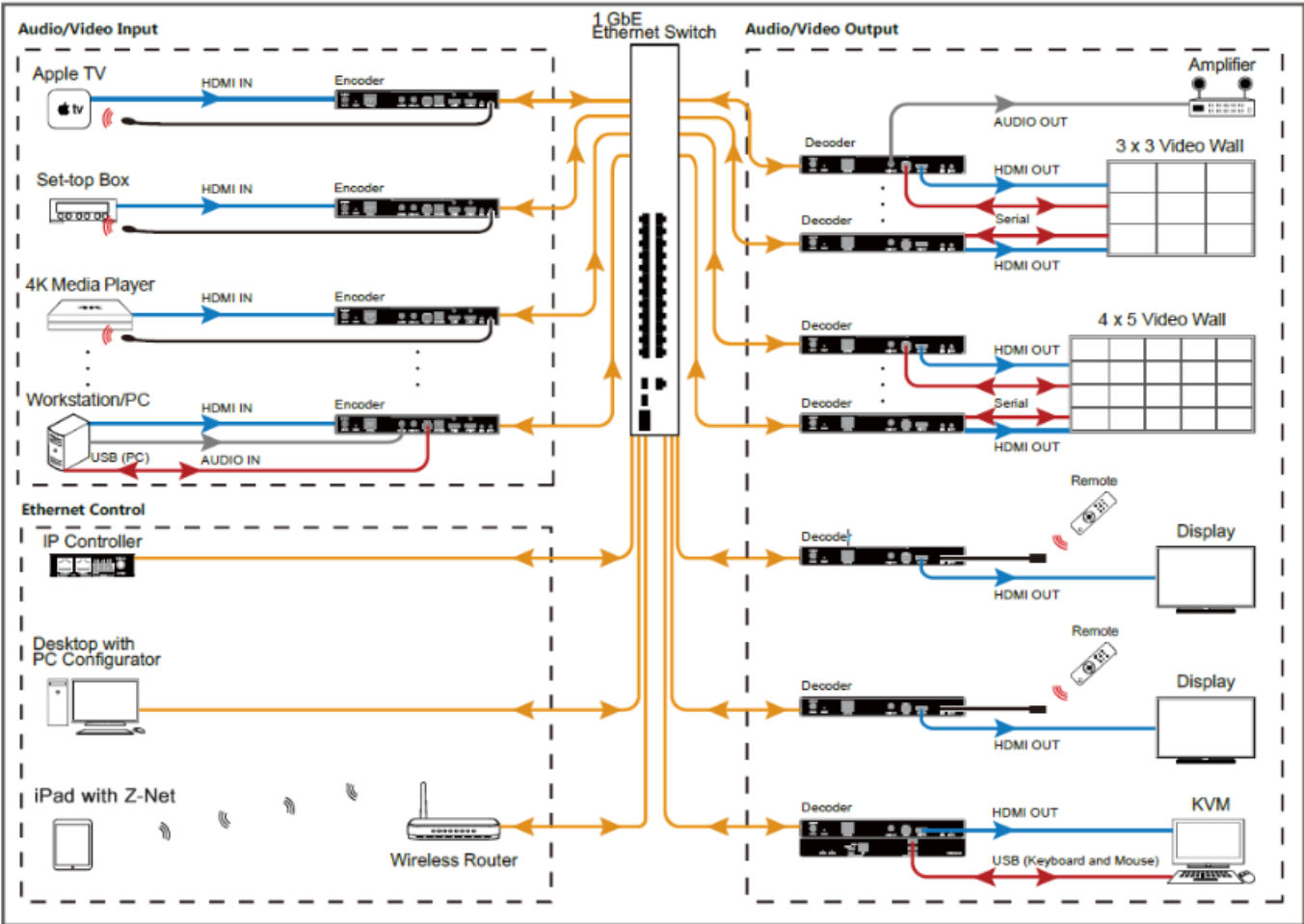

## 6.2 Scenarios 2

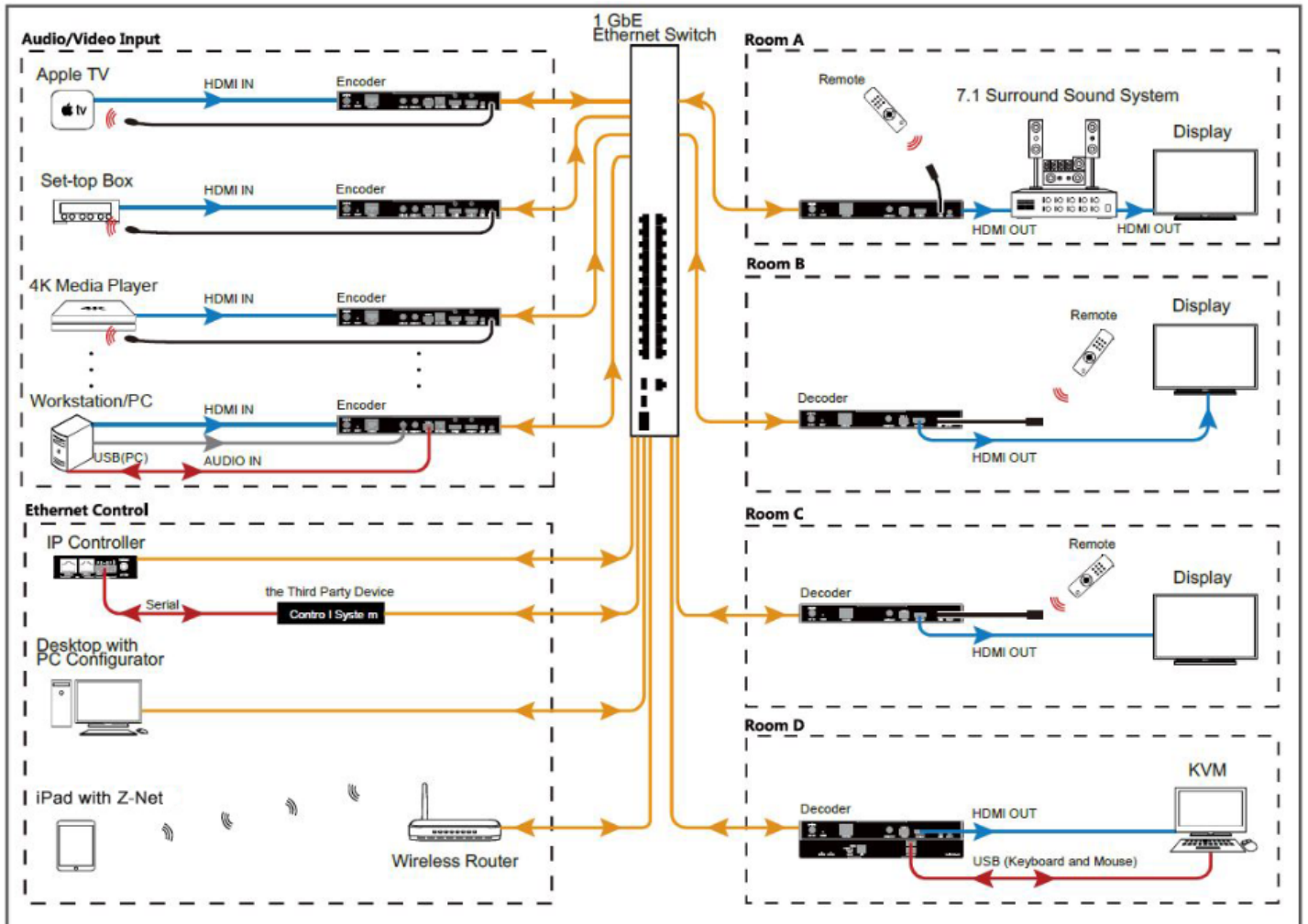

## 7. Hardware Installation

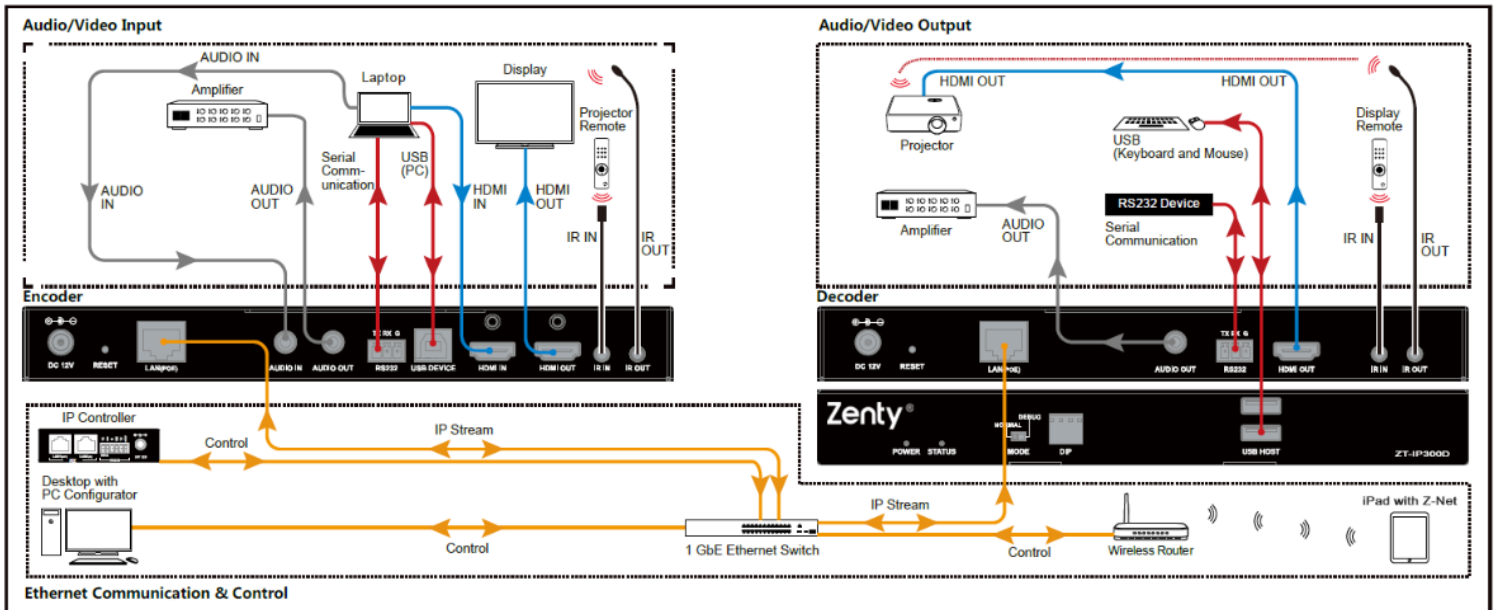

### Note:

- If the Ethernet switch doesn't support PoE, connect encoders and decoders to their power adapters.
- If the PoE switch is unable to provide enough power, connect encoders and decoders to their power adapters

## 8. Operating the Devices

### 8.1 Introduction to Different Operation Tools

The IP300 series products allow you to use the front panel link DIP switch, PC configurator, Z Net and IP controller to manage and control the encoders and decoders. This section briefly introduces how to route the video from source to the display using these tools. By default, audio, video together with IR, and USB signals are routed as a whole. For more information, see their guides. The following tables describes how audio, video together with IR, and USB signals are routed using all the different tools.

Operation Tools	Description
Link DIP switch	Route audio, video together with IR, and USB signals as a whole.
PC configurator	
Z-Net	
IP controller	<p>Both of the following routing policies are available.</p> <ul style="list-style-type: none"> <li>Route audio, video together with IR, and USB signals as a whole.</li> <li>Route audio, video together with IR, and USB signals separately via IP controller's API commands.</li> </ul>

**Note:**

- Operation tools PC configurator, Z-Net and IP controller take priority over the link DIP switch. Link relationship between encoder and decoder performed by the DIP switch can be changed using any other tools.
- When audio, video together with IR, and USB signals are routed via PC configurator, Z-Net and IP controller, press and hold the rear panel RESET button in decoder for less than five seconds to remove the current link relationship between encoder and decoder, reverting to the link relationship set by the link DIP switch.
- When audio, video together with IR, and USB signals are routed separately via IP controller's API commands, they can be routed as a whole with other operation tools.

## 8.2 Using DIP Switch to Perform Routing

Before using the DIP switch, check that routing operations were not performed by other the tools. Otherwise, the switch function is disabled. If so, press and hold the rear panel RESET button in decoder for less than five seconds to enable the DIP switch.

To route the video from source to display, toggle each individual switches of the front panel DIP switch in decoder to the same positions as these in encoder. If you want to link the decoder to a different encoder, change the decoder switch settings in the same way as how the encoder's switch is positioned. If you want to remove their link relationship, reset decoder to its factory defaults.

## 8.3 Using PC Configurator to Perform Fast Switching

In addition to matrix switching between encoders and decoders via PC configurator, it allows users to configure them, including HDCP Hybrid and HDMI Timing Hybrid to function fast switching. For more information, see the user guide of PC configurator.

## 9. Updating the Firmware

You can use MaintainTool to update the encoders and decoders to their latest versions to obtain new features. For more information, see the user guide of MaintainTool.

## 10. Maintenance

Clean this unit with a soft, dry cloth. Never use alcohol, paint thinner, or benzine to clean.

## 11. Warranty

If your product does not work properly because of a defect in materials of workmanship, our company (referred to as “the warrantor”) will, for the length of the period indicated as below, “Parts and Labor (5) Years”, which starts with the date of original purchase (“Limited Warranty period”), at its option

either (a) repair your product with new or refurbished parts, or (b) replace it with a new or a refurbished product. The decision to repair or replace will be made by the warrantor.

During the “Labor” limited warranty period, there will be no charge for labor. During the “Parts” warranty period, there will be no charge for parts. You must mail-in your product during the warranty period. This Limited Warranty is extended only to the original purchaser and only covers products purchased as new. A purchase receipt or other proof of original purchase date is required for Limited Warranty service.

## **12. Mail-In Service**

When shipping the unit, carefully pack and send it prepaid, adequately insured, and preferably in the original carton. Include a letter detailing the complaint and provide a day time phone and/or email address where you can be reached.

## **13. Limited Warranty Limits and Exclusions**

This Limited Warranty ONLY COVERS failures due to defects in material or workmanship, and DOES NOT COVER normal wear and tear or cosmetic damage. The Limited Warranty ALSO DOES NOT COVER damages which occurred in shipment, or failures which are caused by products not supplied by warrantor, or failures which result from accidents, misuse, abuse, neglect, mishandling, misapplication, alteration, faulty installation, set-up adjustments, mis-adjustment of consumer controls, improper maintenance, power line surge, lightning damage, modification, or service by anyone other than a Factory Service center or other Authorized Servicer, or damage that is attributed to acts of God.

THERE ARE NO EXPRESS WARRANTIES EXCEPT AS LISTED UNDER “LIMITED WARRANTY COVERAGE”. THE WARRANTOR IS NOT LIABLE FOR INCIDENTAL OR CONSEQUENTIAL DAMAGES RESULTING FROM THE USE OF THIS PRODUCT, OR ARISING OUT OF ANY BREACH OF THIS WARRANTY. (As examples, this excludes damages for lost time, cost of having someone remove or re-install an installed unit if applicable, travel to and from the service, loss of or damage to media or images, data or other recorded content. The items listed are not exclusive, but are for illustration only.) PARTS AND SERVICE, WHICH ARE NOT COVERED BY THIS LIMITED WARRANTY, ARE YOUR RESPONSIBILITY.



**WWW.ZENTY.COM**  
**9807 EMILY LANE**  
**STAFFORD, TX 77477**

**(844) 200-1945**  
**SUPPORT@ZENTY.COM**  
**SALES@ZENTY.COM**